

# Highlights 01 | 2021

## Bright. Airy. Precise.



DALI-Gateway KNX  
Interface between DALI and KNX



AMUN 716 CO2 Monitor  
Mobile CO<sub>2</sub> sensor

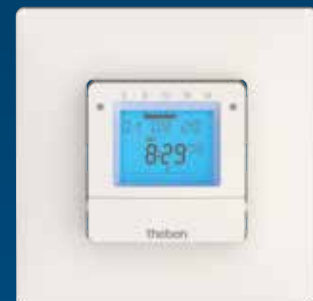

top3 flush-mounted version  
From the control cabinet to  
the switch program

# Diversified Our business areas



## Building automation & smart home

Since 1992, more on [www.theben.de/en](http://www.theben.de/en)

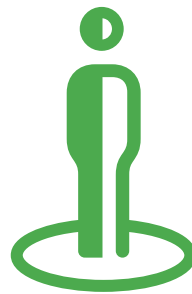

## Presence & motion detectors, lighting

Since 2007, more on [www.theben.de/en](http://www.theben.de/en)



Weather station



Actuator technology



Motion detectors  
(230 V, KNX)



Presence detectors  
(230 V, KNX, DALI)  
Presence sensors  
(DALI-2)



Operating controls



Smart homes

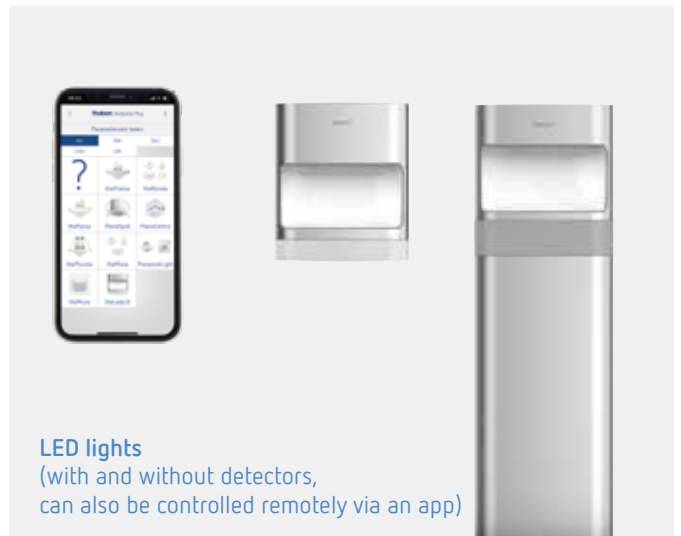

LED lights  
(with and without detectors,  
can also be controlled remotely via an app)



## Time, light & climate control

Since 1921, more on [www.theben.de/en](http://www.theben.de/en)



## Smart metering & smart grid

Since 2010, more on [www.theben.de/en](http://www.theben.de/en)

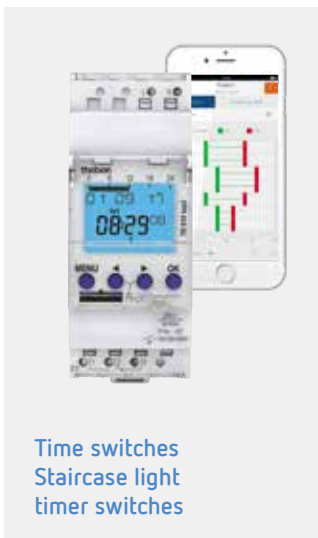

Time switches  
Staircase light  
timer switches



Twilight switches



Smart meter gateway  
(with added-value module)



Dimmers

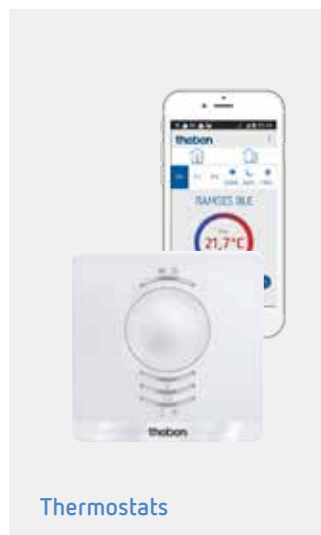

Thermostats



Control box

# KNX – a technology and its unlimited possibilities

Whether universities, schools, or other administrative and office buildings, nursing homes and hospitals, museums, hotels, or private homes – KNX makes more of it. The advantage of a KNX installation is its versatility. Via KNX, all building functions can be linked, programmed, and controlled. Starting with heating, ventilation and room climate control via lighting and shading, up to alarm, safety and information systems.

All these functions can be controlled automatically via intelligent sensors, manually at the control units inside the rooms or centrally via a visualisation – in the house or on the move via smartphone or tablet.



## Theben, KNX and the KNX Association The fieldbus and its history

KNX stands for “Konnex” or “Connectivity” (connection), and it is a fieldbus for building automation. KNX resulted from merging the European organisations EIBA, EHSA, and BCI, which strived for a common standard off the back of the existing field buses. Today, KNX is the global standard for house and building automation (ISO/IEC 14543). Worldwide, there are more than 90,000 trained KNX partners in 190 countries. The directives for KNX technology are defined and regulated by the KNX Association, to which today over 500 companies belong, worldwide. KNX thus stands for extremely high investment security and guaranteed future capability.

Theben joined the association as one of the first members, and as a member of the Executive Committee, we actively influence the development of KNX technology. Since 2015, Theben is also a member of the KNX Technology Committee. In 2019, Theben was the first manufacturer to introduce KNX wireless actuators according to the Data Secure standard. Theben – a competent partner within KNX.

Further information at [www.knx.org](http://www.knx.org)





DALI-Gateway KNX plus

### Description

- The DALI Gateway KNX serves as an interface between the the DALI and the KNX system
- A maximum of 64 DALI members can be connected to a DALI output
- Control in 16 groups or in individual control
- Colour light control with Device Type 8 (DT8) for 16 groups: Colour temperature, XY, RGB, HSV, RGBW
- Time-dependent colour control (also for human centric lighting applications)
- Scene module for 16 scenes (including colour setting DT8)
- Effects module for sequential controls (including colour setting DT8): Colour temperature, XY, RGB, HSV, RGBW
- Energy saving by switching off the electronic ballast power supply in the groups (communication object)
- Easy replacement of ECGs in the event of an error
- Support of single-battery emergency lights (DT1) and emergency light systems with central battery
- LC display (2x 12 characters) for menu guidance during start-up and parameter settings
- Commissioning using the controls on the device, the integrated web server or the free ETS app (DCA)

### Product selection

Type	Article number
DALI-Gateway KNX plus	9070929

### Technical data

DALI-Gateway KNX plus			
Operating voltage KNX	Bus voltage, < 10 mA	Ambient temperature	-5 °C ... +45 °C
Operating voltage	100–240 V AC/DC	Protection class	I
Frequency	50–60 Hz	Type of protection	IP 20
Width	4 modules		



## Description

### Common functions

- The DALI Gateway KNX serves as an interface between the DALI and the KNX system
- A maximum of 64 DALI members can be connected to a DALI output
- Control in 16 groups
- Colour light control with Device Type 8 (DT8) for 16 groups: Colour temperature, XY, RGB, HSV, RGBW
- Time-dependent colour control (also for human centric lighting applications)
- Scene module for 16 scenes (including colour setting DT8)
- Effects module for sequential controls (including colour setting DT8): Colour temperature, XY, RGB, HSV, RGBW
- Energy saving by switching off the electronic ballast power supply in the groups (communication object)
- Easy replacement of ECGs in the event of an error
- Commissioning using the free ETS app (DCA)

### DALI-Gateway S64 KNX

- 1 Kanal für 64 DALI-Leuchten

### DALI-Gateway S128 KNX

- 2 Kanäle für 2x64 DALI-Leuchten

## Product selection

Type	Article number
DALI-Gateway S64 KNX	4940301
DALI-Gateway S128 KNX	4940302

## Technical data

DALI-Gateway S64/S128 KNX			
Operating voltage KNX	Bus voltage, < 10 mA	Ambient temperature	-5 °C ... +45 °C
Operating voltage	100–240 V AC/DC	Protection class	I
Frequency	50–60 Hz	Type of protection	IP 20
Width	4 modules		

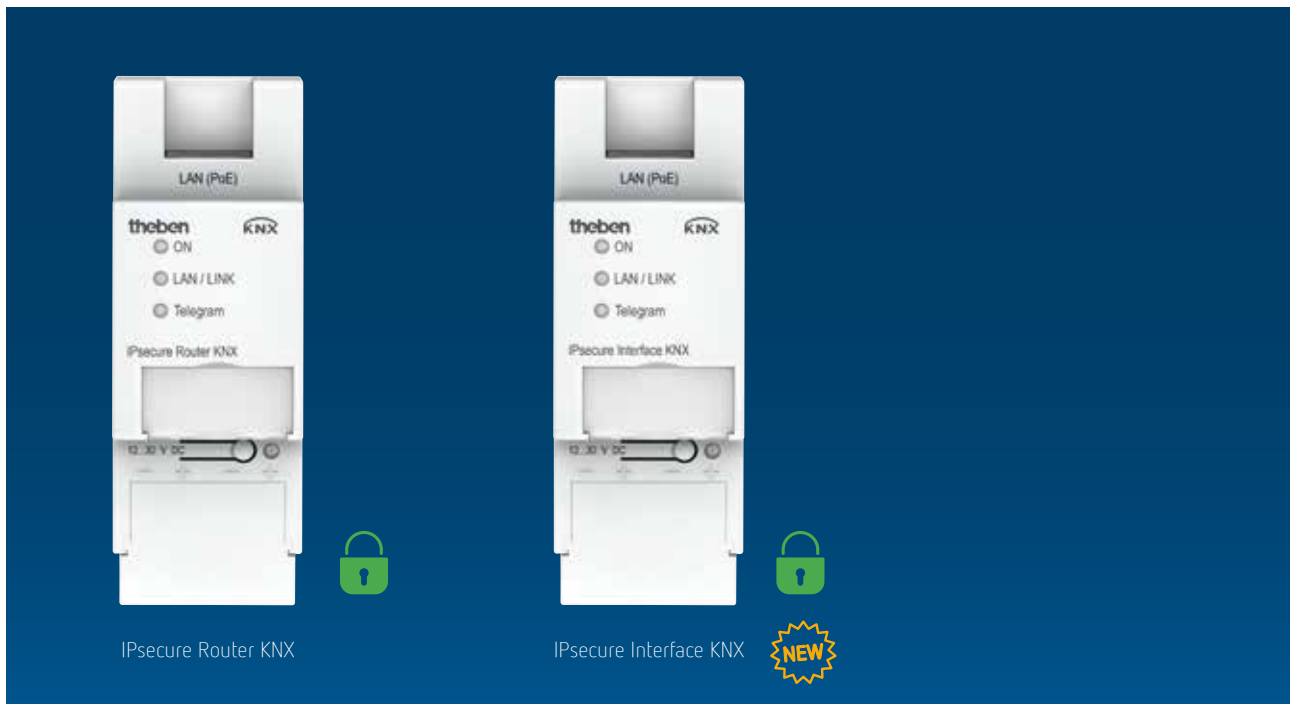

## Description

### IPsecure Router KNX

- Router / interface / line coupler IP and KNX
- For data exchange between KNX and IP networks
- Support of KNX IP Secure
- Meets the requirements of the KNXnet / IP standard
- Complete filter table for all main groups (0... 31)
- Display of power failures on the bus (KNX IP Service)

- Unicast: Up to 10 devices can communicate via unicast
- Tunneling: 5 tunneling servers available (visualization, app ...)
- Firmware update possible (Theben IP Tool Software)
- Power supply: 12 – 30 V DC / PoE - IEEE 802.3af class 1

### IPsecure Interface KNX

- Interface IP and KNX
- Support of KNX IP Secure
- Meets the requirements of the KNXnet / IP standard
- Tunneling: 5 tunneling servers available (visualization, app ...)
- Firmware update possible (Theben IP Tool Software)
- Power supply: 12 – 30 V DC / PoE - IEEE 802.3af class 1

## Product selection

Typ	Article number
IPsecure Router KNX	9070770
IPsecure Interface KNX	9070771

## Technical data

	IPsecure Interface KNX	IPsecure Router KNX
Operating voltage KNX	Bus voltage, ≤10 mA	
Operating voltage	12–30 V DC	
Width	2 TE	
Ambient temperature	-5 °C ... +45 °C	
Protection class	II according to EN 60 730-1	
Type of protection	IP 20	



# Presence and motion detectors

## Presence detectors



### Description

- Passive infra-red presence detector for ceiling installation
- Circular detection area 360°, up to Ø 8 m (50 m<sup>2</sup>)
- Switching output 1 channel light (relay 230 V)
- Automatic presence- and brightnessdependent control for lighting
- Mixed light measurement suitable for fluorescent lamps (FL/PL/ESL), halogen/ incandescent lamps and LEDs
- Choice of fully or semi-automatic operation
- Brightness switching value configurable, teach-in function
- Pulse function for staircase light time switch
- Time delay configurable
- Test mode for checking function and detection area
- Connection option for sensor for manual switching
- Extension of detection area via Master/ Slave switching
- Ready for immediate use due to factory presetting
- Diameter of ceiling cutout 34 – 36 mm
- The changes in the values and Settings can also be used with one of these optional remote controls:
  - App remote control theSenda B
  - Service remote control theSenda P
- Optional user remote control theSenda S

### Product selection

Type of installation	Channel	Operating voltage	Colour	Type	Article number
Ceiling installation	Light	110–240 V AC	White	thePiccola P360-100 DE WH	2090200

### Technical data

thePiccola P360-100 DE WH			
Operating voltage	110–240 V AC	Fluorescent lamp load (conventional) parallel-corrected	1300 VA, 140 µF
Frequency	50–60 Hz	Fluorescent lamp load (conventional) series-corrected	2000 VA
Installation height	2–6 m (at least 1,7 m)	Fluorescent lamp load (electronic ballast)	1200 W
Power consumption	0,5 W	LED lamp < 2 W (typ.)	55 W
Setting range brightness	5–1000 lx	LED lamp > 2 W (typ.)	600 W
Light switch-off delay	pulse (0,5 s), 30 s–30 min	Ambient temperature	–20 °C ... +50 °C
Incandescent/halogen lamp load	2000 W	Schutzart	IP 55 (Sensor), IP 20 (power module) (when mounted)
Fluorescent lamp load (conventional) not corrected	2000 VA		

### Detection range (Round)

Mounting height (A)	Diagonally (T)	Head on to (R)	Sitting (S)
2,5 m	50 m <sup>2</sup>   8 m	3 m <sup>2</sup>   2 m	3 m <sup>2</sup>   2 m

Detection range according to sensNORM IEC 63180 see datasheet

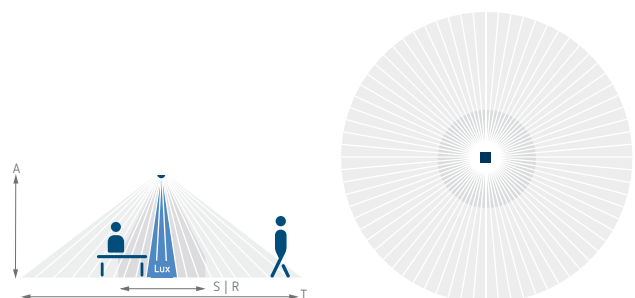



Accessories



**theSenda B**  
↳ Art.Nr.: 9070985  
Details page 20



**theSenda P**  
↳ Art.Nr.: 9070910  
Details page 20



**theSenda S**  
↳ Art.Nr.: 9070911  
Details page 20

Scale drawings

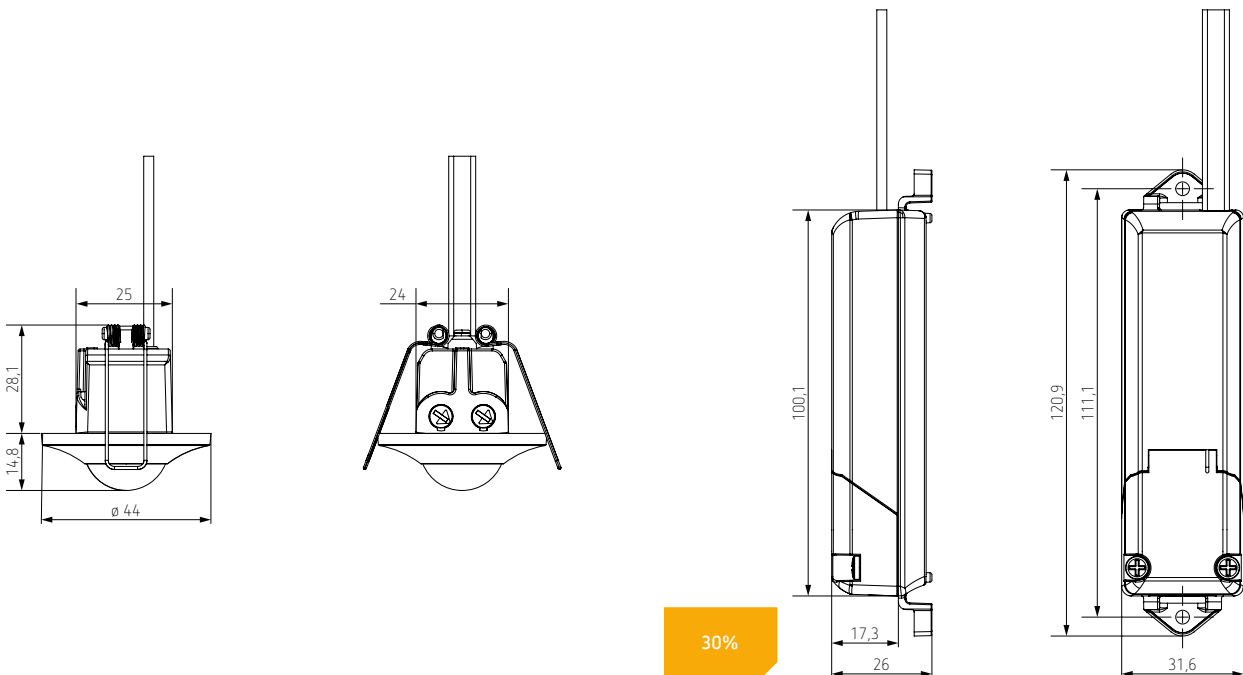

30% smaller power supply than previous device

Connection diagrams

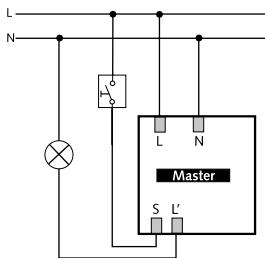

thePiccola P360-100 DE WH

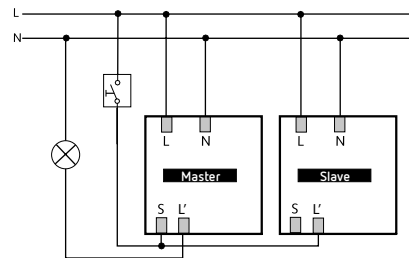

2 x thePiccola P360-100 DE WH

# Presence and motion detectors

## Motion detectors



### Description

- Passive infra-red motion detector for ceiling installation
- Circular detection area 360°, up to Ø 8 m (50 m²)
- Switching output 1 channel light (relay 230 V)
- Automatic motion and brightness-dependent control for lighting
- Mixed light measurement suitable for
- fluorescent lamps (FL/PL/ESL), halogen/
- incandescent lamps and LEDs
- Operation as fully automatic device
- Brightness switching value configurable, teach-in function
- Pulse function for staircase light time switch
- Time delay configurable
- Test mode for checking function and detection area
- Extension of detection area via Master / Slave switching
- Ready for immediate use due to factory
- presetting
- Diameter of ceiling cutout 34–36 mm

### Product selection

Type of installation	Channel	Operating voltage	Colour	Type	Article number
Ceiling installation	Light	110–240 V AC	White	thePiccola S360-100 DE WH	1060200

### Technical data

thePiccola S360-100 DE WH			
Operating voltage	110–240 V AC	Fluorescent lamp load (conventional) parallel-corrected	1300 VA, 140 µF
Frequency	50–60 Hz	Fluorescent lamp load (conventional) series-corrected	2000 VA
Installation height	2–6 m (mindestens 1,7 m)	Fluorescent lamp load (electronic ballast)	1200 W
Power consumption	0,5 W	LED lamp < 2 W (typ.)	55 W
Setting range brightness	5–1000 lx	LED lamp > 2 W (typ.)	600 W
Light switch-off delay	pulse (0,5 s), 30 s–30 min	Ambient temperature	–20 °C ... +50 °C
Incandescent/halogen lamp load	2000 W	Type of protection	IP 55 (Sensor), IP 20 (power module) (when mounted)
Fluorescent lamp load (conventional) not corrected	2000 VA		

### Detection range (Round)

Mounting height (A)	Diagonally (T)	Head on to (R)
2,5 m	50 m <sup>2</sup>   8 m	3 m <sup>2</sup>   2 m

Detection range according to sensNORM IEC 63180 see datasheet

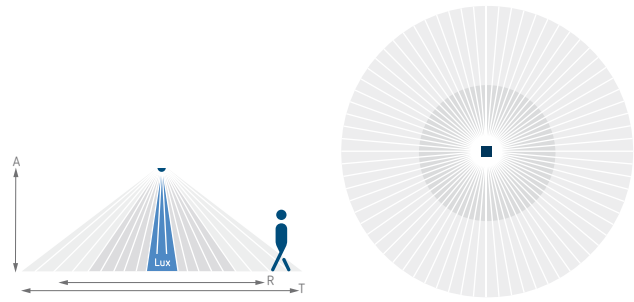

### Scale drawings

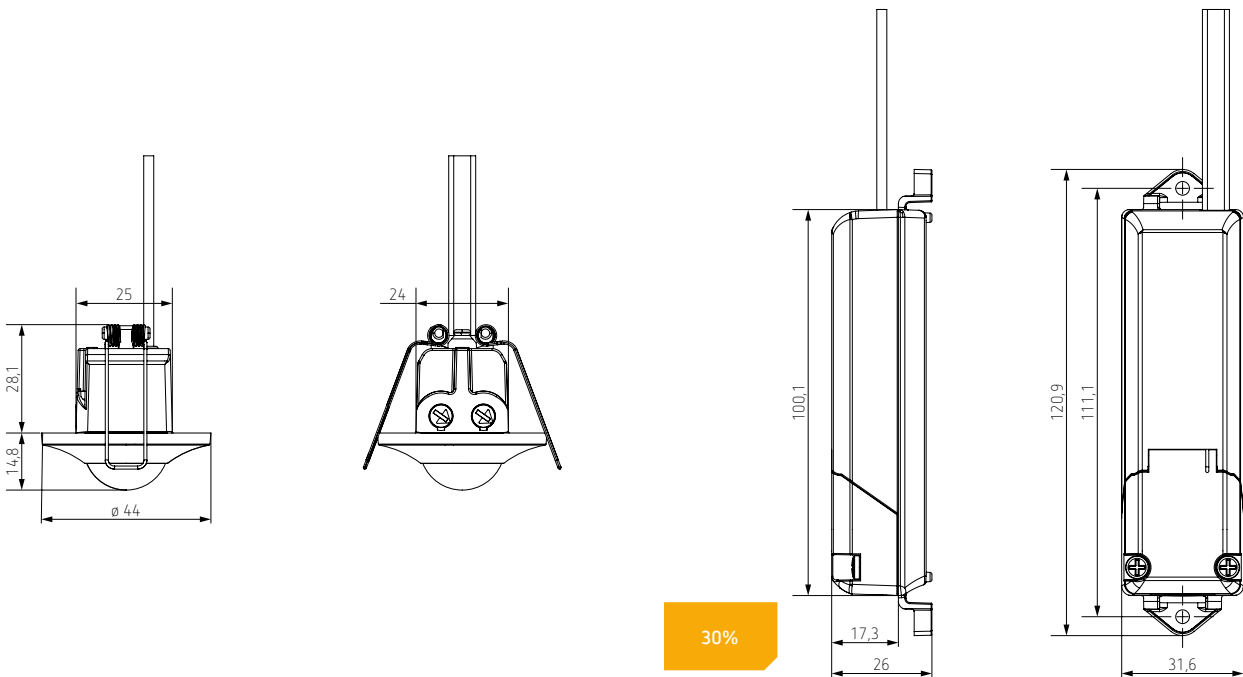

30% smaller power supply than previous device

### Connection diagrams

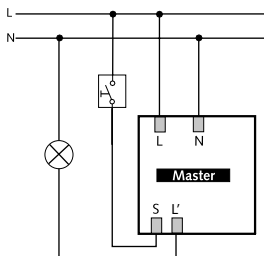

thePiccola S360-100 DE WH

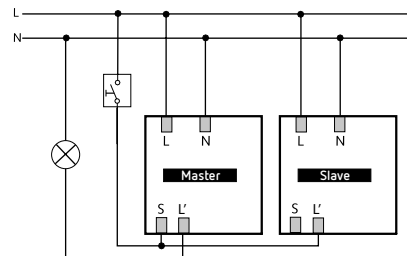

2 x thePiccola S360-100 DE WH

# top3 is ready to move now From the control cabinet into the switching position

All the advantages that you already know from the cabinet mounted devices of the top3 Performance series are now also available as flush-mounted versions. The new digital timers top3 UP fit elegantly into different switch series and have the functionality of the top3 Performance series.



TR 030 top3 UP  
(0300130)



SELEKTA 070 top3 UP  
(0700130)

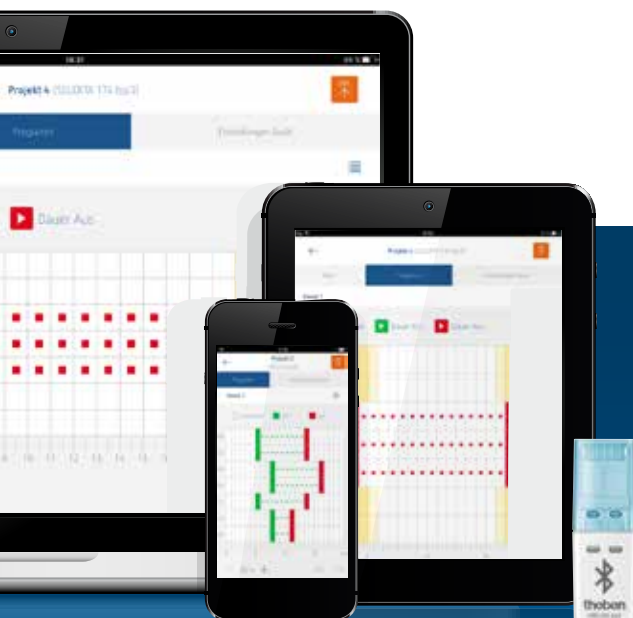







Programming, whenever and wherever you like  
It couldn't be more flexible and convenient!

Create your programs just as you like directly at the top3 device, on a PC or laptop, or via app on a tablet or smartphone. The app is available for Android and iOS.





### Adapter frame for common switch series

	Article	Description	Article number
	Adapter frame 45A BJBSI WH	<b>Adapter frame for switch series Busch-Jaeger</b> balance SI	9070788
 	Adapter frame 45A BJRE WH	<b>Adapter frame for switch series Busch-Jaeger</b> Reflex SI	9070754
	Adapter frame 45A JAS WH	<b>Adapter frame for switch series Jung</b> SERIE A (A 500, A plus, A creation, AS 500)	9070789
	Adapter frame 45A MMP WH	<b>Adapter frame for switch series Merten</b> System M (1-M, Atelier-M, M-Smart, M-Pure, M-Plan, M-Creativ)	9070790
	Adapter frame 45A GS WH	<b>Adapter frame for switch series Gira</b> System 55 (Standard 55, E2, Event, Esprit)	9070791
	Adapter frame 45A BS WH	<b>Adapter frame for switch series Berker</b> S.1	9070792

# Time and light control

## Digital time switches, flush-mounted wall mounting



TR 030 top3 UP



SELEKTA 070 top3 UP



### Description

#### Common functions

- Digital time switch with weekly program for flush-mounted wall mounting
- 1 channel
- Programming by app possible
- Safe transfer via optional Bluetooth Low Energy OBELISK top3
- Maximum manipulation security, time switch programs can only be transferred from the app to the time switch when the Bluetooth OBELISK top3 is plugged into the time switch
- 3 special programs (small annual program)
- 84 memory locations
- DuoFix spring terminals
- Text-oriented user guidance in display
- 6 year power reserve

- Interface for OBELISK top2 memory card (PC programming)
- Switching preselection
- Permanent switching ON/OFF
- Integrated operating hour counter
- Holiday program
- PIN coding
- Automatic summer / winter time changeover
- Adapter frames for common switch ranges available as accessory

#### TR 030 top3 UP

- Digital time switch with weekly program
- Pulse program
- Cycle program
- Random program

#### SELEKTA 070 top3 UP

- Astronomical time switch with weekly program
- Astronomical time switch function (automatic calculation of sunrise and sunset times for the whole year)
- Offset to adjust sunrise and sunset times
- 3 custom twilight ranges plus adjustable offset (sunset, twilight, darkness)
- Astro-pulse
- Programmable ON-OFF switching times, for example for night interruption

### Product selection

Program	Number of channels	Memory locations	Program functions	Operating voltage	Type	Article number
Weekly program	1	84	ON-OFF, Pulse, Cycle	230 V AC	TR 030 top3 UP	0300130
Weekly program, Astro program	1	84	ON-OFF, Pulse	230 V AC	SELEKTA 070 top3 UP	0700130

# Time and light control

## Digital time switches, flush-mounted wall mounting

### Technical data

	TR 030 top3 UP/SELEKTA 070 top3 UP
Operating voltage	230 V AC
Frequency	50 Hz
Type of contact	NO contact
Power reserve	6 years
Switching capacity at 250 V AC, $\cos \varphi = 1$	10 A
Switching capacity at 250 V AC, $\cos \varphi = 0,6$	2 A
Incandescent/halogen lamp load 230 V	2300 W
LED lamp < 2 W (typ.)	50 W
LED lamp < 2 W (typ.)	600 W
Switching capacity min.	10 mA
Shortest switching times	1 s
Time accuracy at 25 °C	typical $\pm 0,25$ s/day (quartz)
Stand-by consumption	0,4 W
Type of protection	IP 20
Protection class	II according to EN 60 730-1
Ambient temperature	-5 °C ... +55 °C

### Accessories



#### Bluetooth OBELISK top3

↳ Art.No.: 9070130  
Details page 21



#### PC set OBELISK top2/3

↳ Art.No.: 9070409  
Details page 21



#### Memory card OBELISK top2

↳ Art.No.: 9070404  
Details page 21



#### Various Adapter frames

Details page 21

### Scale drawings

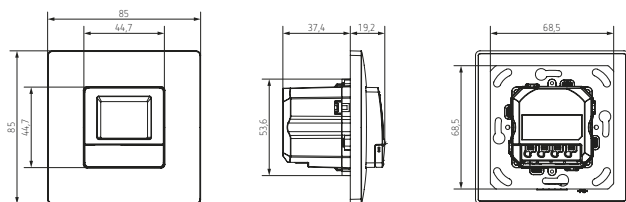

### Connection diagram

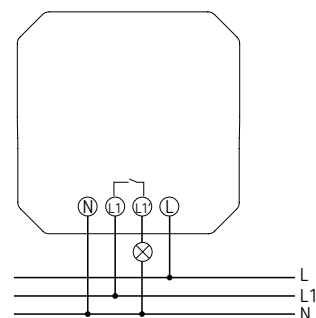



# AMUN 716 CO<sub>2</sub> Monitor

## Ventilate properly



When lots of people share a room, the air can get stale. This is mostly caused by exhaled carbon dioxide (CO<sub>2</sub>). The results are: Reduction in well-being, concentration and performance.

### Classification of breathing air quality according to the Federal Environment Agency

CO <sub>2</sub> content in the room	Hygienic assessment	Recommendations
< 1.000 ppm	hygienically harmless	no further action
1.000 bis 2.000 ppm	hygienically conspicuous	Check and improve ventilation measures, ventilation behavior
> 2.000 ppm	hygienically unacceptable	Check whether the room can be ventilated; further measures if necessary



## Reliably measure CO<sub>2</sub> concentration

CO<sub>2</sub> sensors from Theben monitor CO<sub>2</sub> concentrations in schools and classrooms, in offices and meeting rooms or in passive and low-energy buildings. CO<sub>2</sub> sensors thereby make a decisive contribution to indoor air quality.



Mobile CO<sub>2</sub> sensor with USB cable to measure air quality



For schools/kindergartens, offices or meeting rooms and living spaces



In the event of a potentially dangerous CO<sub>2</sub> concentration, the device visually warns via the LED traffic light system, so that ventilation can be optimized immediately and return to a healthy indoor climate



LED traffic light system on the AMUN 716 CO<sub>2</sub> monitor

# Climate control

## CO2 sensors



AMUN 716 CO2 Monitor

### Description

- Mobile CO<sub>2</sub> sensor with USB cable for measuring air quality
- Suitable for schools/nurseries, offices, conference or meeting rooms and living spaces
- The device warns optically via the LED traffic light system in case of a potentially dangerous CO<sub>2</sub> concentration - so ventilation can be optimized immediately and a healthy room climate can be created
- Green threshold value: Up to 1,000 ppm CO<sub>2</sub>, hygienically ok, everything is in the green range!
- Threshold value orange: Up to 2,000 ppm CO<sub>2</sub>, hygienically noticeable, Aeration - good idea!
- Threshold value red: Over 2,000 ppm CO<sub>2</sub>, hygienically unacceptable, Ventilation is an absolute must!
- Fresh air must be supplied and the used air removed at latest when the red threshold value is reached
- Includes USB cable for easy setup
- Stand and non-slip pad included, alternative wall mounting is also possible
- Development based on the recommendation for CO<sub>2</sub> in indoor air of the Federal Environment Agency according to various guidelines, e.g. the Bavarian „Guideline for the Promotion of Investment Costs for Technical Measures for Infection-Protection-Compatible Ventilation in Schools (FILS-R)

### Product selection

Display	Operating voltage	Type	Article number
LED	USB	AMUN 716 CO2 Monitor	7169100

### Technical data

AMUN 716 CO2 Monitor			
Operating voltage	5 V DC via USB bus voltage	Display	6 LEDs
Measuring range CO <sub>2</sub>	0–5000 ppm	Installation type	Stand and non-slip pad included, alternative wall mounting is also possible
Accuracy	0-1000 ppm: ± (50 ppm + 3% from the measured value)	Type of protection	IP 20
	1001-2000 ppm: ± (50 ppm + 5% from the measured value)	Protection class	III
	> 2000 ppm: ± (100 ppm + 5% from the measured value)	Length usb cable	1,5 m

### Scale drawings

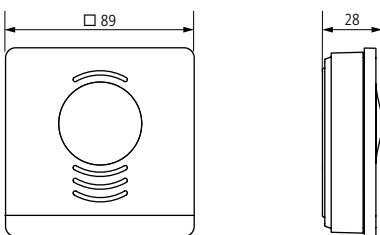

Application images



# Everything at a glance

## Overview

### KNX DALI-Gateway (more information is available on page 6)

Type	Description	Article number	Available from
DALI-Gateway KNX plus	The DALI Gateway KNX serves as an interface between the DALI and the KNX system	9070929	Available
DALI-Gateway S64 KNX	Interface between the DALI and the KNX system 1 channel for 64 DALI lights	4940301	February 2021
DALI-Gateway S128 KNX	Interface between the DALI and the KNX system 2 channels for 2x64 DALI lights	4940302	February 2021

### KNX system devices (more information is available on page 7)

Typ	Description	Article number	Available from
IPsecure Router KNX	Router / interface / line coupler IP and KNX	9070770	Available
IPsecure Interface KNX	Interface IP and KNX	9070771	March 2021

### Presence and motion detectors for ceiling installation (more information is available on page 8)

Typ	Description	Article number	Available from
thePiccola P360-100 DE WH	Presence detector (PIR), circular detection area 360°, Ø 8 m (50 m <sup>2</sup> ) at 2.5 m mounting height	2090200	Available
thePiccola S360-100 DE WH	Motion detector (PIR), circular detection area 360°, Ø 8 m (50 m <sup>2</sup> ) at 2.5 m mounting height	1060200	Available
theSenda B	„theSenda B“ app remote control (optional) and corresponding „theSenda Plug“ app (for iOS/Android)	9070985	Available
theSenda P	Installation remote control	9070910	Available
theSenda S	User remote control	9070911	Available

### Digital time switches for flush-mounted wall mounting (more information is available on page 12)

Typ	Description	Article number	Available from
TR 030 top3 UP	Digital time switch with weekly program for flush-mounted wall mounting	0300130	February 2021
SELEKTA 070 top3 UP	Astronomical time switch with weekly program for flush-mounted wall mounting	0700130	February 2021
Bluetooth OBELISK top3	Bluetooth low-energy dongle for the transfer of switching programs and direct commands from the app to the time switch	9070130	Available
PC set OBELISK top2/3	Consisting of: Memory card, USB plug adapter, software	9070409	Available
Memory card OBELISK top2	Individual memory card	9070404	Available
Adapter frame 45A BJBSI WH	Adapter frame for switch series Busch-Jaeger balance SI	9070788	Available
Adapter frame 45A BJRE WH	Adapter frame for switch series Busch-Jaeger Reflex SI	9070754	April 2021
Adapter frame 45A JAS WH	Adapter frame for switch series Jung Serie A (A 500, A plus, A creation, AS 500)	9070789	Available
Adapter frame 45A MMP WH	Adapter frame for switch series Merten System M (1-M, Atelier-M, M-Smart, M-Pure, M-Plan, M-Creativ)	9070790	Available
Adapter frame 45A GS WH	Adapter frame for switch series Gira System 55 (Standard 55, E2, Event, Esprit)	9070791	Available
Adapter frame 45A BS WH	Adapter frame for switch series Berker S.1	9070792	Available

### CO<sub>2</sub>-Sensor (more information is available on page 16)

Typ	Description	Article number	Available from
AMUN 716 CO2 Monitor	Mobile CO <sub>2</sub> sensor with USB cable for measuring air quality	7169100	Available

Theben is member of:



Follow Theben online:



# theben

Theben AG  
Hohenbergstraße 32  
72401 Haigerloch, Germany  
Phone +49 7474 692-0  
Fax +49 7474 692-150  
info@theben.de  
www.theben.de/en

**Service hotline**  
hotline@theben.de  
+49 7474 692-369  
Mon–Thu 7:00–18:00, Fr 7:00–16:00

9900654 0521 Subject to technical changes and improvements.

