

cimco

CIMCO-BASICS



SICHER SEIT 1827.

cimco
SICHER SEIT 1827.

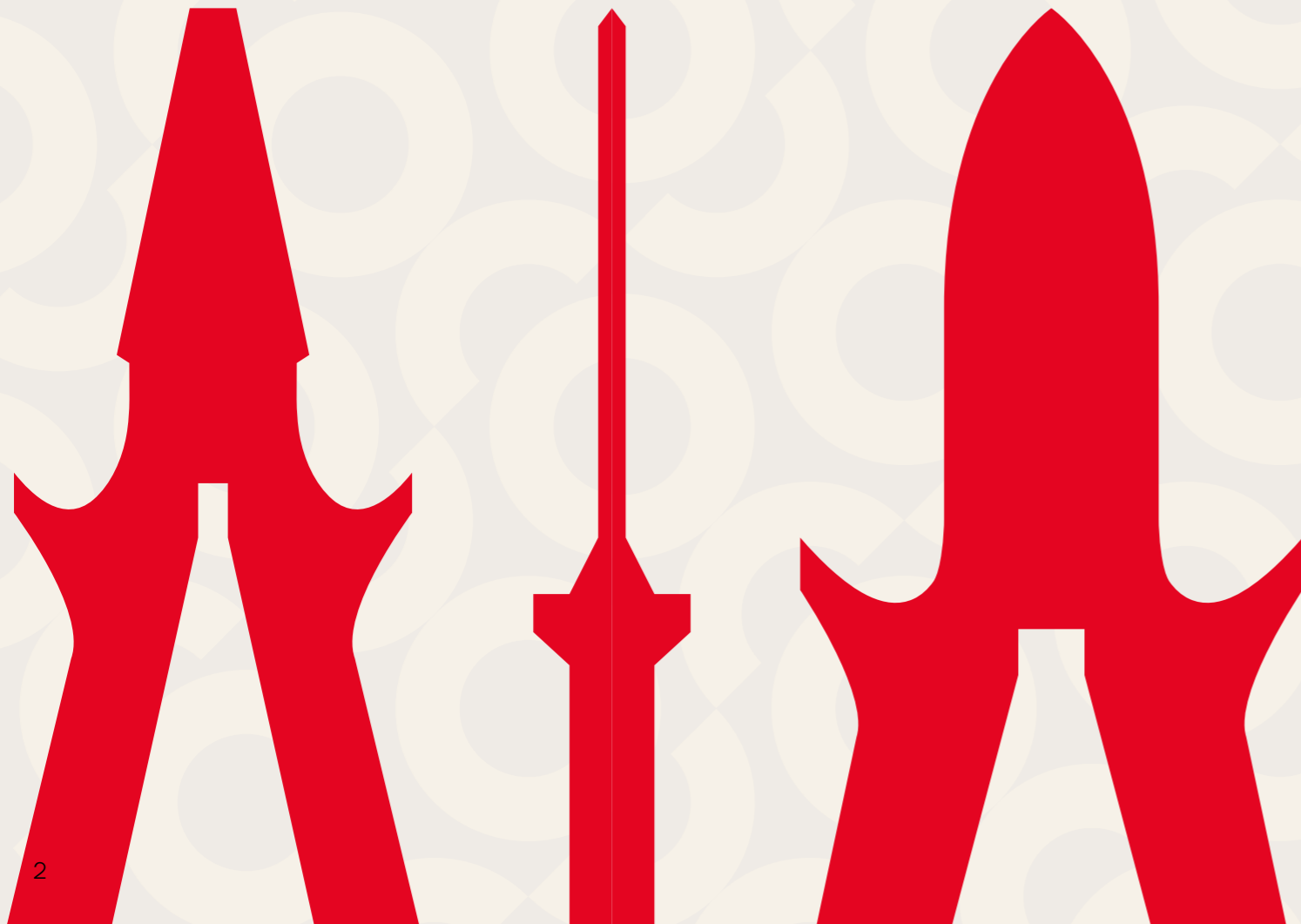

We are fully loaded.

The only constant is change? Not quite true. There are tools that were developed once and always remain good. Simply basic electronics equipment that every professional will appreciate. Always equally reliable, always equally safe.

In addition to the large selection of CIMCO basics shown here, you can find all other products from our extensive range on our website cimco.de



cimco.de

Craftsmanship and devotion

At CIMCO, we value craftsmanship – and have done so for almost 200 years and in the sixth generation of the family. Today, we provide electricians throughout Germany and other European countries with tools that meet the highest standards. And even though they are no longer made by hand, but in largely automated production processes automated production processes, we have not forgotten that precision craftsmanship is our top priority.

We subject all screwdrivers and pliers that leave our halls to rigorous testing. In addition to the German Equipment Safety Act (GS) and current DIN standards, CIMCO tools are also subject to strict in-house testing in a water bath at 10,000 V AC and are suitable for use at 1,000 V AC.



Where electricity should flow, tools are needed.

Our electricians are part of a constantly growing industry. There are around 6,500 electrical installation companies in Germany today, and the trend is rising, not least thanks to digitalisation. Power lines are the lifelines of our economic activity, our work and our entire infrastructure. We know that you, who work for us under high voltage in the truest sense of the word, deserve our full support. Because you give your all in your job every day.

You deserve optimised products that are constantly adapted to new challenges and allow you to work comfortably and ergonomically. You deserve outstanding service and absolute safety when working with our tools. Whether it's wire strippers or screwdrivers, tool cases or cable ties: we want you to be able to rely on our tools and products throughout your working life.



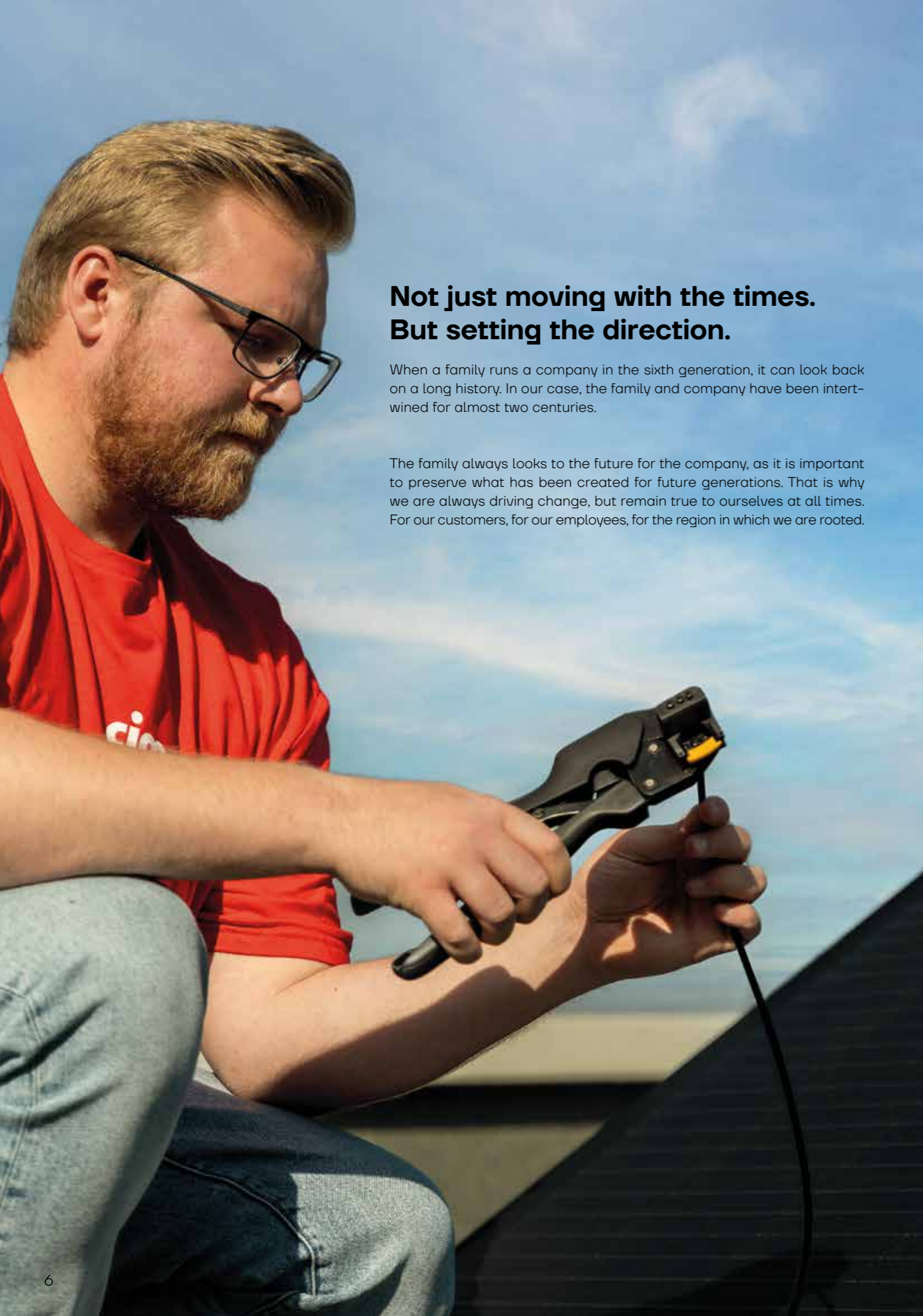

Not just moving with the times. But setting the direction.

When a family runs a company in the sixth generation, it can look back on a long history. In our case, the family and company have been intertwined for almost two centuries.

The family always looks to the future for the company, as it is important to preserve what has been created for future generations. That is why we are always driving change, but remain true to ourselves at all times. For our customers, for our employees, for the region in which we are rooted.

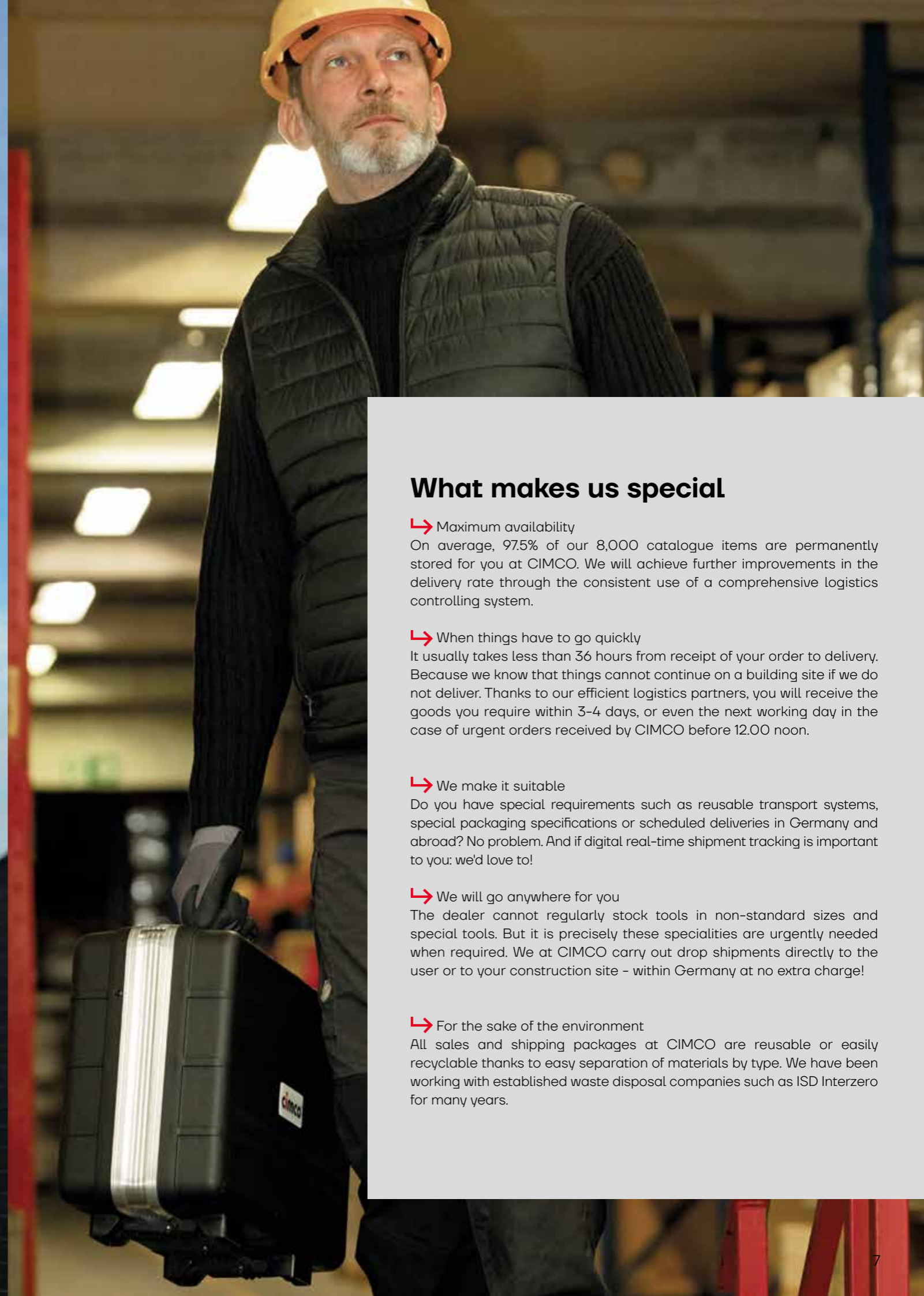

What makes us special

↳ Maximum availability

On average, 97.5% of our 8,000 catalogue items are permanently stored for you at CIMCO. We will achieve further improvements in the delivery rate through the consistent use of a comprehensive logistics controlling system.

↳ When things have to go quickly

It usually takes less than 36 hours from receipt of your order to delivery. Because we know that things cannot continue on a building site if we do not deliver. Thanks to our efficient logistics partners, you will receive the goods you require within 3-4 days, or even the next working day in the case of urgent orders received by CIMCO before 12.00 noon.

↳ We make it suitable

Do you have special requirements such as reusable transport systems, special packaging specifications or scheduled deliveries in Germany and abroad? No problem. And if digital real-time shipment tracking is important to you: we'd love to!

↳ We will go anywhere for you

The dealer cannot regularly stock tools in non-standard sizes and special tools. But it is precisely these specialities are urgently needed when required. We at CIMCO carry out drop shipments directly to the user or to your construction site - within Germany at no extra charge!

↳ For the sake of the environment

All sales and shipping packages at CIMCO are reusable or easily recyclable thanks to easy separation of materials by type. We have been working with established waste disposal companies such as ISD Interzero for many years.



↳ CHAMPION tool case trolley, equipped

- Professional hard-shell case with integrated castor system
- Particularly stable due to extra wide castors on the outer shell of the case
- Telescopic system adjustable to 2 heights

Content: 22 quality tools

1,000 V Telephone pliers, curved jaws, 200 mm	10 0238
Screw pliers, 160 mm	10 0352
1,000 V Side cutters, 200 mm	10 0528
Power Strip automatic wire stripper, 0.5 - 16 mm ø	10 0770
Electronics diagonal cutters up to 1.3 mm ø, 21°, 132 mm	10 1040
Crimping pliers system click ,n' crimp, electrical engineering	10 6000
Universal switch cabinet spanner made of die-cast zinc	11 2894
1,000 V slotted screwdriver 3.0 x 0.5 x 185 mm	11 7702
4.0 x 0.8 x 185 mm	11 7704
5.5 x 1.0 x 220 mm	11 7705
1,000 V cross-head screwdriver PZ 1 x 80 mm	11 7741
PZ 2 x 100 mm	11 7742
1,000 V Special screwdriver with combination profile PZ FL 1 x 80 mm	11 7751
PZ FL 2 x 100 mm	11 7752
1,000 V Screwdriver TX T 10 x 60 mm	11 7910
T 15 x 75 mm	11 7915
T 20 x 100 mm	11 7920
T 25 x 100 mm	11 7925
JOKARI ALLROUNDER cable stripper, 4 - 15 mm ø	12 0009
JOKARI Locator Box	12 9009
VDE cable shears, 180 mm	12 0114
Professional spirit level, Plumb Site Dual View, 250 mm	21 1528
Dimensions L x W x H	410 x 478 x 253 mm
Weight equipped	9,800 g
Item no. 17 0601	

↳ INDUSTRY technician's case, equipped

- Professional hard-shell tool case
- Numerous pockets
- Equipped with 2 lockable tilt locks

Content: 22 quality tools



1,000 V Telephone pliers, curved jaws, 200 mm	10 0238
Screw pliers, 160 mm	10 0352
1,000 V Side cutters, 200 mm	10 0528
Electronics diagonal cutters up to 1.3 mm ø, 21°, 132 mm	10 1040
1,000 V slotted screwdriver 3.0 x 0.5 x 185 mm	11 7702
4.0 x 0.8 x 185 mm	11 7704
5.5 x 1.0 x 220 mm	11 7705
1,000 V cross-head screwdriver PZ 1 x 80 mm	11 7741
PZ 2 x 100 mm	11 7742
1,000 V Special screwdriver with combination profile PZ FL 1 x 80 mm	11 7751
PZ FL 2 x 100 mm	11 7752
1,000 V Screwdriver TX T 10 x 60 mm	11 7910
T 15 x 75 mm	11 7915
T 20 x 100 mm	11 7920
T 25 x 100 mm	11 7925
JOKARI ALLROUNDER cable stripper, 4 - 15 mm ø	12 0009
Power Strip automatic wire stripper, length 170 mm	10 0770
VDE cable shears, 180 mm	12 0114
Universal control cabinet key	11 2894
Professional spirit level, Plumb Site Dual View, 250 mm	21 1528
Crimping pliers system click ,n' crimp, electrical engineering	10 6000
JOKARI Locator Box	12 9009
Dimensions L x W x H	395 x 455 x 205 mm
Weight equipped	6,500 g
Item no. 17 0603	

↳ HIGHLIGHTS



↳ ECO Apprentice case, equipped

- Robust, made of impact-resistant polypropylene with sturdy aluminium frame
- Rubberised handle
- 2 robust, lockable tilt locks incl. 2 keys

Dimensions L x W x H	395 x 455 x 205 mm
Weight equipped	5,700 g
	Item no. 17 0500



↳ ECO Apprentice backpack, equipped

- Robust, weatherproof backpack made of polyester with plastic shell for a secure stand
- Side eyelets and pockets for additional storage space
- Padded back, wide carrying straps

Dimensions L x W x H	370 x 210 x 490 mm
Weight equipped	4,500 g
	Item no. 17 0400

↳ You can find all other apprentice cases and backpacks in our current brochure and on our website cimco.de

To the brochure



Content: 23 quality tools

1,000 V telephone pliers, straight jaws, 200 mm	10 0216
1,000 V diagonal pliers, 160 mm	10 0574
DUOCUT cable shears, 160 mm	12 0108
VDE slot-head screwdriver 3.0 x 0.5 x 100 mm	11 7702
4.0 x 0.8 x 100 mm	11 7704
5.5 x 1.0 x 125 mm	11 7705
VDE cross-head screwdriver PH 1 x 80 mm	11 7731
PH 2 x 100 mm	11 7732
VDE cross-head screwdriver PZ 1 x 80 mm	11 7741
PZ 2 x 100 mm	11 7742
Voltage tester, 2-pin	11 1442
JOKARI SUPER 4 PLUS wire stripper	10 0780
JOKARI cable stripping knife without blade, 8–28 mm ø	12 1014
JOKARI inside socket sheath stripper wand, 8–13 mm ø	12 2027
Plaster cup made from soft rubber, 120 mm ø	14 0306
Painter's spatula, 40 mm	13 1324
Water brush, ø 24 mm	14 0310
PUK pocket saw, span width 150 mm	12 0502
1,000 V safety cable stripping knife	12 1042
Cross peen hammer, according to DIN 1041/1193, 300 g	13 0804
Wooden folding ruler, with steel spring, length 2 m	21 0004
Carpenter's pencil, HB lead, 240 mm	21 2170
Switch cabinet spirit level, 230 mm	21 1540





↳ **Industrial case PRO, equipped**

- Robust, made of impact-resistant polypropylene with sturdy aluminium frame
- Rubberised handle
- 2 robust, lockable tilt locks incl. 2 keys

Dimensions L x W x H	395 x 455 x 205 mm
Weight equipped	6.600 g
	Item no. 17 0605



↳ **Industrial case PRO with trolley, equipped**

- Hard-shell tool case with integrated roller system
- With convenient telescopic pull-out
- Numerous pockets

Dimensions L x W x H	395 x 455 x 205 mm
Weight equipped	7.700 g
	Item no. 17 0608

Content: 21 quality tools

Screw pliers, 160 mm	10 0352
Electronic diagonal pliers up to 3.1 mm ø, 21°, 132 mm	10 1040
1,000 V diagonal pliers, 200 mm	10 0528
VDE cable shears, 180 mm	12 0114
VDE slot-head screwdriver SLIM	
3.0 x 0.5 x 100 mm	11 7760
4.0 x 0.8 x 100 mm	11 7764
5.5 x 1.0 x 125 mm	11 7768
VDE Pozidriv cross-head screwdriver SLIM	
PZ 1 x 80 mm	11 7776
PZ 2 x 100 mm	11 7778
VDE special screwdriver with combination profile SLIM	
PZ FL 1 x 80 mm	11 7780
PZ FL 2 x 100 mm	11 7782
VDE TX screwdriver SLIM	
T 10 x 60 mm	11 7784
T 15 x 75 mm	11 7786
T 20 x 100 mm	11 7788
T 25 x 100 mm	11 7790
Automatic wire stripper	10 0730
Professional switch cabinet spirit level, 250 mm	21 1528
Universal switch cabinet key made of die-cast zinc	11 2894
"Cut Pro" cut-resistant gloves, size 10/XL	14 1210
1,000 V telephone pliers with bent jaws, 200 mm	10 0238
FLEXI-CRIMP 6 crimping pliers for wire end ferrules	10 1950





Dimensions L x W x H	630 x 490 x 300 mm
Weight equipped	20,150 g
	Item no. 17 6846

↳ Gigant tool case trolley XL, equipped

- Water and dust-protected to IP67
- Made from acid and pressure-resistant materials
- Impact-resistant, airtight shell protects the tool
- Innovative lamella system for a firm hold of all tools
- Manual pressure equalisation valve
- Two gas pressure dampers enable convenient opening and closing
- Maximum security thanks to the use of up to eight shackle locks

Content: 36 quality tools

1,000 V telephone pliers, straight jaws, 200 mm	10 0216
1,000 V combination pliers, 180 mm	10 0336
1,000 V diagonal pliers, 160 mm	10 0574
Screw pliers, 160 mm	10 0352
Electronic diagonal cutters 120 mm, with cutting blade	10 0802
Water pump pliers with handles, 250 mm	10 1224
Automatic wire stripper FLEXI-STRIP 16 system	10 7000
Crimping pliers system click ,n' crimp, electrical engineering	10 6000
Parting reamer 100 mm, round	11 0482
Ball-end hexagon socket spanner set, 7-piece	11 0596
AC/DC TrueRMS current clamp	11 1411
Non-contact voltage tester VOLTFIX	11 1460
AC/DC voltage tester 1,000 V AC / 1,500 V DC	11 1429
Precision screwdriver set, 7 pieces	11 1864
VDE TX screwdriver SLIM	
T 10 x 60 mm	11 7784
T 15 x 75 mm	11 7786
T 20 x 100 mm	11 7788
T 25 x 100 mm	11 7790
VDE slot-head screwdriver SLIM	
3.0 x 0.5 x 100 mm	11 7760
4.0 x 0.8 x 100 mm	11 7764
5.5 x 1.0 x 125 mm	11 7768
VDE cross-head screwdriver Phillips SLIM	
PH 1 x 80 mm	11 7777
PH 2 x 100 mm	11 7779
VDE special screwdriver with combination profile SLIM	
PZ FL 1 x 80 mm	11 7780
PZ FL 2 x 100 mm	11 7782
VDE slot-head screwdriver SLIM 6.5 x 150 mm	11 7706
VDE screwdriver interchangeable blade set, 18 pieces	11 7862
Bit box, 10 pieces	11 4604
Digital Laser Distance Measurer FVP-30	21 1563
DUOCUT cable shears, 160 mm	12 0108
Universal shears, 190 mm	12 0122
PROFI pocket saw, span width 150 mm	12 0490
Cable stripping knife	12 0050
JOKARI Cable stripping knife with hook-shaped blade, 8 - 28 mm ø	12 1010
Professional tape measure, 5 m	21 0105
Work glove GRIP FLEX, size 10/XL	14 1231





↳ Tool bag „VDE“, equipped

- All outer edges reinforced with aluminium brackets
- Side panels, front and rear wall, base and lid extra reinforced
- Front and rear wall can be opened at a 90° angle

Content: 53 quality tools

1,000 V plastic flat nose pliers, 200 mm	10 0796
1,000 V Telephone pliers with straight jaws 200 mm	10 8778
1,000 V Telephone pliers with bent jaws 200 mm	10 8780
1,000 V Combination pliers with flat jaws 185 mm	10 8782
1,000 V high-leverage diagonal cutting pliers 200 mm	10 8784
1,000 V Wire stripper with adjusting screw, 160 mm, 0.75 - 6 mm ²	10 8790
1,000 V Offset screwdriver size 5	11 0804
size 6	11 0806
Voltage tester up to 690 V, LED display	11 1432
1,000 V socket wrench insert, ½ inch square socket size 10	11 2600
size 11	11 2602
size 13	11 2606
size 14	11 2608
size 17	11 2610
size 19	11 2612
1,000 V Reversible ratchet, ½ inch	11 2628
1,000 V T-handle, ½ inch	11 2650
1,000 V Open-ended spanner size, 15° cranked size 10	11 2708
size 13	11 2714
size 17	11 2720
size 19	11 2722
size 22	11 2724
1,000 V slot-head screwdriver 2.5 x 0.4 x 160 mm	11 7701
4.0 x 0.8 x 185 mm	11 7704
6.5 x 1.2 x 245 mm	11 7706
8.0 x 1.2 x 285 mm	11 7708
1,000 V cross-head Screwdriver PH 1 x 80 mm	11 7731
PH 2 x 100 mm	11 7732
1,000 V nut driver 5.5 x 125 x 220 mm	11 7805
7.0 x 125 x 235 mm	11 7807
8.0 x 125 x 235 mm	11 7808
10.0 x 125 x 235 mm	11 7810
1,000 V One-hand cable shears 160 mm, up to 16 mm	12 0206
1,000 V Safety cable stripping knife, blade length 50 mm	12 1042
1,000 V protection slip-on snout, max. diameter 10 mm ø 5 x size 1	14 0166
5 x size 2	14 0168
5 x size 3	14 0170
2 x Plastic clip, 160 mm	14 0180
1,000 V Electrical safety gloves, size 10, material thickness 1.0 mm	14 0214
Insulating tape universal, colour red, 25 mm x 25 m	16 0145

Dimensions L x W x H	505 x 270 x 435 mm
Weight equipped	13,500 g
	Item no. 17 0378



↳ Gigant-S-tool case, empty

- Water and dust-protected to IP67
- Made from acid and pressure-resistant materials
- Impact-resistant, airtight shell protects the tool
- Innovative lamella system for a firm hold of all tools

Document tray	1
Tool board with slats	2
Easy-Open-Locks	2
Dimensions L x W x H	475 x 415 x 215 mm
Weight empty	6,500 g

Item no. 17 0092



↳ CHAMPION tool case trolley, empty

- Professional hard-shell case with integrated castor system
- Particularly stable due to extra wide castors on the outer shell of the case
- Telescopic system adjustable to 2 heights

Trolley function	✓
Document tray	1
Tool board	3
Tilt locks, lockable	2
Dimensions L x W x H	410 x 478 x 253 mm
Weight empty	6,850 g

Item no. 17 0932

↳ You can find more tool cases on our website cimco.de

To the tool cases



↳ 1,000 V pliers also available as immersion-insulated VDE version

↳ 1,000 V Heavy duty diagonal pliers

- Proximity of the material to be cut to the centre of rotation ensures lever arm and higher cutting force
- High precision even when machining spring steel wires
- DIN ISO 5749

Length mm	Item no.
160	10 0526
200	10 0528

↳ 1,000 V diagonal pliers

- Reliable cutting tool for a wide range of applications in electrical installation
- Highly precise even with the finest stranded wires
- Clean cutting result at the cutting tips
- DIN ISO 5749

Length mm	Item no.
145	10 0572
160	10 0574
180	10 0577

↳ 1,000 V stripping diagonal pliers

- With precise stripping function for 1.5 and 2.5 mm² conductors
- Inductively hardened precision cutting edge for perfect cutting results
- DIN ISO 5749

Length mm	Item no.
160	10 0652

↳ 1,000 V combination pliers

- Reliable combination: gripping and cutting with one tool
- High-precision work without changing tools
- Cutting of soft and hard wire
- DIN ISO 5746

Length mm	Item no.
160	10 0334
180	10 0336
200	10 0338





↳ **1,000 V wire stripper**

- Pliers with adjusting screw for easy adjustment to the to the desired wire or strand diameter
- For solid and stranded conductors
- Stripping values up to \varnothing 5 mm or cross-sections from 0.75 to 6 mm²
- With internal opening spring

Length mm	Item no.
160	10 0686

↳ **1,000 V telephone pliers with straight jaws**

- Round nose pliers with long, straight jaws, with serrated cut-out (burner hole) and cutting function
- Serrated cut-out (burner hole)
- Cutting edge for soft and hard wire
- DIN ISO 5745

Length mm	Item no.
160	10 0214
200	10 0216

↳ **1,000 V telephone pliers with bent jaws**

- Round nose pliers with long, straight jaws, with serrated cut-out (burner hole) and cutting function
- Jaws 45° angled
- Serrated cut-out (burner hole)
- Cutting edge for soft and hard wire
- DIN ISO 5745

Length mm	Item no.
160	10 0236
200	10 0238

↳ **Water pump plier**

- With box joint, self-clamping on the tool
- With ridged opening (burner hole)
- DIN ISO 8976

Length mm	Item no.
250	10 1224



↳ **1,000 V pliers set, 4 pieces**

- VDE-tested and approved for 1,000 V AC:
- Power diagonal cutters, 200 mm
- Telephone pliers, 200 mm
- Combination pliers, 180 mm
- Wire stripper, 160 mm

Item no.
10 4020



↳ **1,000 V pliers set, 3 pieces**



- VDE-tested and approved for 1,000 V AC:
- Diagonal pliers, 160 mm
- Telephone pliers, 200 mm
- Combination pliers, 180 mm

Item no.
10 4021



↳ **Electronic diagonal pliers**

- High-precision design made of special steel
- Easily self-opening thanks to double leaf springs
- Excellent durability, finely ground surfaces

Item no.
Oval-round head, diagonal, with side face  10 0802
Pointed head, flat, with side face  10 0806

↳ **Electronic diagonal pliers**

- Precision ground cutting edges
- Self-opening thanks to smooth spiral spring
- Setting angle 21°, Soft wires up to 1,3 mm \varnothing

Item no.
without side face  10 1040



↳    **1,000 V slot-head screwdriver**

- Insulated screwdrivers according to IEC 60900
- Individually tested in a water bath with a testing voltage of 10,000 V
- According to DIN EN 60900; VDE 0682 - 201; DIN ISO 2380

Size mm	Length mm	Item no.
2.5 x 0.4 x 75	160	11 7701
3.0 x 0.5 x 100	185	11 7702
3.5 x 0.6 x 100	185	11 7703
4.0 x 0.8 x 100	185	11 7704
5.5 x 1.0 x 125	220	11 7705
6.5 x 1.2 x 150	245	11 7706
8.0 x 1.2 x 175	285	11 7708
10.0 x 1.6 x 200	310	11 7710

↳    **1,000 V phillips cross-head screwdrivers**

- Insulated screwdrivers according to IEC 60900
- Individually tested in a water bath with a testing voltage of 10,000 V
- According to DIN EN 60900; VDE 0682 - 201; DIN ISO 8764

Size mm	Length mm	Item no.
PH 0 x 60	145	11 7730
PH 1 x 80	165	11 7731
PH 2 x 100	195	11 7732
PH 3 x 150	260	11 7733

↳    **1,000 V pozidriv cross-head screwdrivers**



- Insulated screwdrivers according to IEC 60900
- Individually tested in a water bath with a testing voltage of 10,000 V
- According to DIN EN 60900; VDE 0682 - 201 - 01; DIN ISO 8764

Size mm	Length mm	Item no.
PZ 0 x 60	145	11 7740
PZ 1 x 80	165	11 7741
PZ 2 x 100	195	11 7742
PZ 3 x 150	260	11 7743

↳    **1,000 V special screwdrivers with combination profile**

- Insulated screwdrivers according to IEC 60900
- Individually tested in a water bath with a testing voltage of 10,000 V
- For combined slot-head/crosshead screws in electrical equipment. e.g. terminal blocks
- According to DIN EN 60900; VDE 0682 - 201

Size mm	Length mm	Item no.
PZ FL 1 x 80	145	11 7751
PZ FL 2 x 100	165	11 7752
Set PZ FL 1 + PZ FL 2		11 7750

↳    **1,000 V screwdrivers TX**

- Insulated screwdrivers according to IEC 60900
- Individually tested in a water bath with a testing voltage of 10,000 V
- According to DIN EN 60900; VDE 0682 - 201

Size mm	Length mm	Item no.
T 10 x 60	155	11 7910
T 15 x 75	170	11 7915
T 20 x 100	195	11 7920
T 25 x 100	195	11 7925

↳    **1,000 V nut drivers**

- Insulated screwdrivers according to IEC 60900
- Individually tested in a water bath with a testing voltage of 10,000 V
- According to DIN EN 60900; VDE 0682 - 201

Size mm	Length mm	Item no.
SW 7 x 125	235	11 7807
SW 8 x 125	235	11 7808
SW 10 x 125	235	11 7810
SW 13 x 125	235	11 7813



1931



Cimco

1935



cimco

2024



Cimco

1979



cimco

1999



↳ **1,000 V electrician screwdriver set, 7 pieces**

Screwdrivers for slot-head screws	
2.5 x 0.4 x 75 mm	11 7701
3.0 x 0.5 x 100 mm	11 7702
4.0 x 0.8 x 100 mm	11 7704
5.5 x 1.0 x 125 mm	11 7705
Screwdrivers for cross-head screws	
PH 1 x 80 mm	11 7731
PH 2 x 100 mm	11 7732
VDE voltage tester (250 V AC)	11 1280

Item no.
11 7800



↳ **1,000 V electrician screwdriver set, 7 pieces**

Screwdrivers for slot-head screws	
2.5 x 0.4 x 75 mm	11 7701
3.0 x 0.5 x 100 mm	11 7702
4.0 x 0.8 x 100 mm	11 7704
5.5 x 1.0 x 125 mm	11 7705
Screwdrivers for cross-head screws	
PZ 1 x 80 mm	11 7741
PZ 2 x 100 mm	11 7742
VDE voltage tester (250 V AC)	11 1280

Item no.
11 7802



↳ **1,000 V screwdriver TX set, 5 pieces**

Screwdrivers for TX screws	
T 8 x 60 mm	11 7908
T 10 x 60 mm	11 7910
T 15 x 75 mm	11 7915
T 20 x 100 mm	11 7920
T 25 x 100 mm	11 7925

Item no.
11 7900



↳ **1,000 V nut driver set, 5 pieces**

Screwdrivers for hexagon head screws	
SW 5.5 x 125 mm	11 7805
SW 7 x 125 mm	11 7807
SW 8 x 125 mm	11 7808
SW 10 x 125 mm	11 7810
SW 13 x 125 mm	11 7813

Item no.
11 7801



↳ **1,000 V special screwdrivers with combination profile SLIM**

- Narrow blade insulation to improve accessibility of recessed screws
- According to IEC 60900, classification VDE O682, part 201
- Individually tested in a water bath with a testing voltage of 10,000 V

Size mm	Length mm	Item no.
PZ FL 1 x 80	165	11 7780
PZ FL 2 x 100	195	11 7782
Set PZ FL 1 + PZ FL 2		11 7781

↳ **1,000 V screwdriver set SLIM, 5 pieces**

Screwdrivers for slot-head screws	
3.0 x 0.5 x 100 mm	11 7760
4.0 x 0.8 x 100 mm	11 7764
5.5 x 1.0 x 125 mm	11 7768
Screwdrivers for cross-head screws	
PZ 1 x 80 mm	11 7776
PZ 2 x 100 mm	11 7778

Item no.
11 7850



↳ **1,000 V cross-head screwdriver set SLIM, 6 pieces**

Screwdrivers for slot-head screws	
3.0 x 0.5 x 100 mm	11 7760
4.0 x 0.8 x 100 mm	11 7764
Screwdrivers for cross-head screws	
PZ 1 x 80 mm	11 7776
PZ 2 x 100 mm	11 7778
Screwdrivers for screws with combination profile	
PZ FL 1 x 80 mm	11 7780
PZ FL 2 x 100 mm	11 7782

Item no.
11 7852



↳ **1,000 V screwdriver set TX SLIM, 6 pieces**

Screwdrivers for TX screws	
T 10 x 60 mm	11 7784
T 15 x 75 mm	11 7786
T 20 x 100 mm	11 7788
T 25 x 100 mm	11 7790
Screwdrivers for screws with combination profile	
PZ FL 1 x 80 mm	11 7780
PZ FL 2 x 100 mm	11 7782

Item no.
11 7854



↳ **Precision screwdriver set, 7 pieces**

- The optimum tools especially for smallest screws in electronic and electrical components
- Blades made of special steel
- Colour-coding ring for marking the screw system

Screwdrivers for slot-head screws	
2.0 x 0.4 x 60 mm	11 1864
2.5 x 0.4 x 75 mm	11 1865
3.0 x 0.5 x 75 mm	11 1866
3.5 x 0.6 x 100 mm	11 1868
4.0 x 0.8 x 150 mm	11 1870
Screwdrivers for cross-head screws	
PH 0 x 60 mm	11 1877
PH 1 x 80 mm	11 1880

Item no.
11 1901



↳ **Voltage tester, 120 - 250 VC**

- With clear transparent, impact-resistant plastic haft
- VDE tested

W x L mm	Testing range	Size mm	Item no.
3,0 x 65	120 - 250 VC	140	11 1280
3,0 x 100	120 - 250 VC	190	11 1288



↳ **Voltage tester, 150 - 250 VC**

- Ergonomically shaped triangular handle in transparent, impact-resistant plastic
- Manufactured according to current DIN standard, VDE/GS tested

W x L mm	Testing range	Size mm	Item no.
3,0 x 65	150 - 250 VC	155	11 1282



↳ **1,000 V torque screwdriver set, 9 pieces**

- Torque adjustment without additional tools, can be changed by means of an adjustable locking mechanism
- When the torque is reached: audible and perceptible click signal
- Tightening torque 1 - 5 Nm, setting level 0,02 Nm
- Screwdriver handle and replacement blades are insulated up to 1,000 V AC according to IEC 60900 and GS

Content:

- Replacement blade for slot-head screws
3.0 x 0.4 x 100 mm · 4.0 x 0.8 x 100 mm
5.5 x 1.0 x 100 mm · 6.5 x 1.2 x 100 mm
- Replacement blade for crosshead screws
PH 1 – PH 2 x 100 mm · PZ 1 – PZ 2 x 100 mm
- VDE screwdriver handle

Item no.
11 4806

↳ **Replacement blades for 1,000 V torque screwdriver**

Size mm	Item no.
T 10 x 100	11 4886
T 15 x 100	11 4887
T 20 x 100	11 4889
T 25 x 100	11 4888



Size mm	Item no.
PZ FL 1 x 100	11 4883
PZ FL 2 x 100	11 4885



↳ **1,000 V screwdriver replacement blades set, 8 pieces**

- Screwdriver handle in 2-component design with replacement blade holder
- Replacement blades generally insulated with bronzed blade tip, with plug-on rotating cap for electronic work
- Screwdriver handle and replacement blades are insulated up to 1,000 V AC according to IEC 60900 and GS

Content:

- Replacement blade for slot-head screws
3.0 x 0.4 x 100 mm · 4.0 x 0.8 x 100 mm
5.5 x 1.0 x 100 mm · 6.5 x 1.2 x 100 mm
- Replacement blade for crosshead screws
PH 1 – PH 2 x 100 mm
- Rotating cap for replacement blade
- VDE screwdriver handle

Item no.
11 7860



↳ **1,000 V screwdriver replacement blades set, 18 pieces**

- Screwdriver handle in 2-component design with replacement blade holder
- Replacement blades generally insulated with bronzed blade tip, with plug-on rotating cap for electronic work
- Screwdriver handle and replacement blades are insulated up to 1,000 V AC according to IEC 60900 and GS

Content:

- Replacement blade for slot-head screws
3.0 x 0.4 x 100 mm · 4.0 x 0.8 x 100 mm
5.5 x 1.0 x 100 mm · 6.5 x 1.2 x 100 mm
- Replacement blade for crosshead screws
PH 1 – PH 2 x 100 mm · PZ 1 – PZ 2 x 100 mm
- Replacement blade for TX screws
T 10 - T 15 - T 20 x 100 mm
- Replacement blade with triangular socket 8 x 100 mm
- Replacement blade with square socket 6 – 8 x 100 mm
- Replacement blade with two-way key bit 5 x 100 mm
- Voltage tester 110 - 250 V
- Rotating cap for replacement blade
- VDE screwdriver handle

Item no.
11 7862



↳ **1,000 V VDE DUOCUT cable shears**

- Innovative cable shears for copper and aluminium cables
- Handles of the shears can be opened up to 140 °
- VDE/GS approved, according to IEC 60900 and VDE 0682/part 201

The two-stage cutting zone:

1. Large blade for sheathed cables up to max. 10 mm ø
2. Small blade for single conductors up to max. 4 mm ø

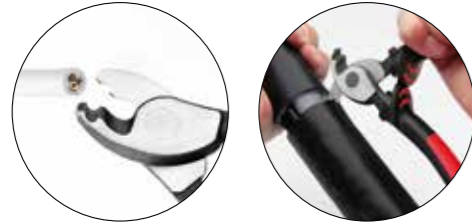

Length mm	Item no.
160	12 0108

↳ **1,000 V VDE DUOCUT cable shears 12**

- Innovative cable shears for copper and aluminium cables
- Handles of the shears can be opened up to 140 °
- VDE/GS approved, according to IEC 60900 and VDE 0682/part 201

The two-stage cutting zone:

1. Large blade for sheathed cables up to max. 12 mm ø
2. Small blade for single conductors up to max. 4 mm ø



Length mm	Item no.
200	12 0112



↳ **1,000 V VDE cable shears**

- For copper and aluminium cables
- With special blade for fine-wire cables up to ø 18 mm
- VDE/GS tested, according to IEC 60900 and VDE 0682/Part 201

Length mm	Item no.
180	12 0114

↳ **One-hand ratchet cable cutter**

- For crush-free cutting of cables with a maximum outside diameter of 45 mm
- Not suitable for steel wire, steel reinforced cables and hard-drawn copper conductors
- Neat cut thanks to sharp, specially hardened blades and thanks to ratchet mechanism with needle bearing eccentric transmission
- Movable, fully swivelling and unlockable in any position unlockable cutting edge



Max. cutting performance			
Cu (copper)	max. ø		45 mm
	multi-wire	300 mm ² / 600 MCM	
	Sector-shaped conductor	3 x 70 SM	
Al (aluminium)	max. ø		45 mm
	multi-wire	400 mm ² / 800 MCM	
	Sector-shaped conductor	4 x 70 SE	

Item no.
12 0168

↳ **One-hand ratchet cable cutter**

Max. cutting performance			
Cu (copper)	max. ø		65 mm
	multi-wire	400 mm ² / 800 MCM	
	Sector-shaped conductor	4 x 150 SM	
Al (aluminium)	max. ø		60 mm
	multi-wire	400 mm ² / 800 MCM	
	Sector-shaped conductor	4 x 185 SE	



Item no.
12 0178



↳ **Electrician scissors with holster**

- For cutting and stripping insulation from cables with diameters of up to 16 mm (50 mm²)
- Ergonomic two-component handle with glass fibre reinforcement
- Blades made of stainless steel HRC 56 AISI 420, 4 mm with serrated edge

Item no.
12 0126



↳ **Electrician scissors**

- For cutting and insulationstripping of conductors and cables up to 22 mm ø
- Blades made from non-rusting VA-vanadium-molybdenum alloy, one blade finely serrated

Item no.
12 0130



↳ **Pipe cutter SUPER**

- New, reinforced design with ratchet mechanism
- Easy shortening of already laid pipes thanks to handy gun shape
- The blade symmetry provides precise right angle cuts without burrs or deformation
- Area of application: Hard and soft plastics, rubber hoses, Isoflex pipes, hard and soft plastic PVC pipes

Working range
6 - 35 mm ø

Item no.
12 0410



↳ **1,000 V house connection set, 21 pieces**

- In a transport and storage case made of impact-resistant plastic, consisting of dip-insulated tools:

Content:

- each 1 x extension 1/4" and bit sockets for 75, 100, 150 mm
- each 1 x socket wrench insert 1/4" and bit sockets for 6, 8, 10, 13, 14 mm
- each 1 x slot-head screws 4.0 x 0.5 mm, 5.5 x 0.8 mm, 6.5 x 1.2 mm
- each 1 x Phillips cross-head screws PH 1, PH 2
- each 1 x crosshead screws combi profile PZ FL1, PZ FL 2
- each 1 x hex socket 5, 6, 8 mm
- 1 x torque wrench 1/4" and bit sockets for 5 - 25 Nm
- 2 x bit holder 1/4"

Item no.
17 0362



↳ **1,000 V NH safety handle**

- According to VDE 0680/4
- With anti-slip protection and protective guard of smooth, impregnated leather
- For NH fuses sizes 00-3

Item no.
14 0210



↳ Work glove **GRIP FLEX**

- Knitted glove with knitted cuff and special coating
- Nitrile nubs on palm and fingertips
- High wearing comfort and high grip

Size mm	Item no.
8/M	14 1229
9/L	14 1230
10/XL	14 1231
11/XXL	14 1233



↳ Work glove **SKINNY SOFT WHITE**

- Nylon glove with knitted cuff and PU coating
- Partially coated on palm and fingertips (touchscreen)
- Very close fitting with high grip

Size mm	Item no.
8/M	14 1281
9/L	14 1263
10/XL	14 1264
11/XXL	14 1265



↳ Work glove **SKINNY TOUCH**

- Nylon glove with knitted cuff and PU coating
- Partially coated on palm and fingertips (touchscreen)
- Very close fitting with high grip feeling

Size mm	Item no.
8/M	14 1235
9/L	14 1237
10/XL	14 1238
11/XXL	14 1239



↳ Work glove **STANDARD SKINNY FLEX**

- Knitted glove with knitted cuff
- Partially coated on palm and fingertips (touchscreen)
- Very close fitting with high grip

Size mm	Item no.
8/M	14 1225
9/L	14 1266
10/XL	14 1267
11/XXL	14 1268



↳ Work glove **WORKER 2.0**

- Mechanic's glove with velcro wrist closure
- Premium quality, very good sense of touch, breathable
- Inner surface made of supple and durable nappa leather

Size mm	Item no.
8/M	14 1244
9/L	14 1245
10/XL	14 1246
11/XXL	14 1247



↳ Cut protection glove **CUT PRO**

- Cut protection glove made from special yarn with PU coating
- High cut protection and protection against contact heat (100°C for 15 seconds)

Size mm	Item no.
8/M	14 1208
9/L	14 1209
10/XL	14 1210
11/XXL	14 1211



↳ Work glove **SKINNY SOFT**

- Nylon glove with knitted cuff and PU coating
- Partially coated on palm and fingertips (touchscreen)
- Very close fitting with high grip

Size mm	Item no.
8/M	14 1248
9/L	14 1260
10/XL	14 1261
11/XXL	14 1262



↳ **Ear muffs**

- CE according to EN241-1
- Flat ear muffs, seal cushion gentle to skin, head piece with comfortable foam cushion
- Comfortable for all head sizes due to sliding mechanism

	Item no.
medium noise protection	14 0274



↳ **Personal safety set, 5 pieces**

In a practical and sturdy carrying bag

Electrician's hardhat	14 0200
Electrician's face guard	14 0252
NH safety handle	14 0210
Electrician's gloves	14 0214
Insulating mat	14 0224

	Item no.
	14 0250



↳ **Personal safety starter set, 5 pieces**

In a practical and sturdy carrying bag

Electrician's hardhat	14 0200
EXPLORER safety glasses	14 0205
Ear plugs	14 0279
Fine dust mask FFP2	14 0284
Work gloves SKINNY SOFT	14 0292

	Item no.
	14 6817



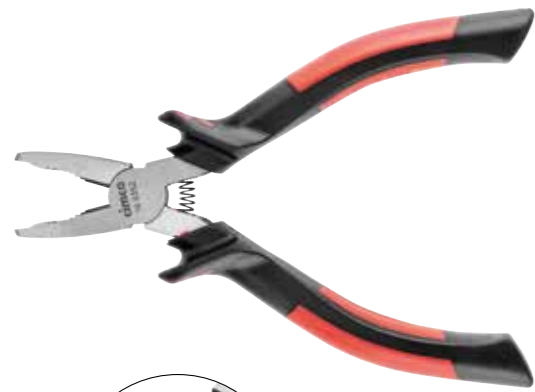

Problem solver
↳ **Screw pliers**

- Patented screw pliers is the ideal problem solver for embedded, dirty or corrosion-damaged screws.
- The special head shape of the pliers securely surrounds the screw head, thus loosening the screws
- Induction hardened precision blade (approx. 58 HRC) for hard, medium-hard and soft wire
- For all self-tapping or metric screws from M2 - M6



Length mm	Item no.
160	10 0352



Problem solver
↳ **Socket wrench set SPECIAL, 7 pieces**

- With the help of the special key shape, it is even possible to undo damaged (rounded) hexagon head screws
- Hex sockets with 3/8"-square drive and drive T-handle made from chrome vanadium steel
- Im Kunststoffkoffer

Item no.
11 3160

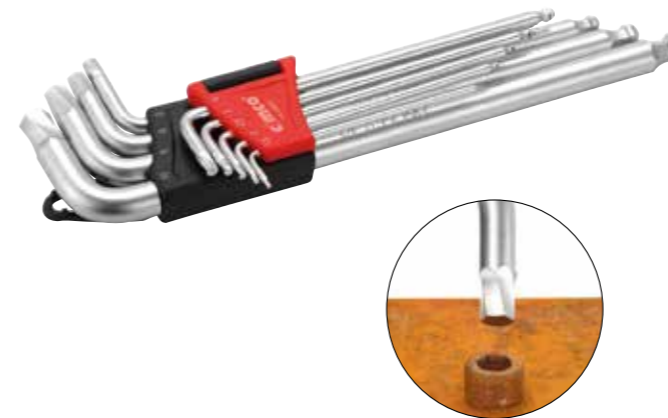

Problem solver
↳ **Hex key set SPECIAL, 9 pieces**

- With the help of the special key shape, it is even possible to undo damaged (rounded) hex socket screws
- Extra long blade with ball-end, made of fully hardened S2 special steel, polished
- In a practical plastic holder with a belt clip

Item no.
11 0606

AE ZAE



↳ Front crimping pliers FLEXI-CRIMP PRO

- Crimping ranges set with selector switch 0.5 to 6 mm² and 6 to 16 mm²
- Square crimp, ideal fit for the clamping technology
- High-precision crimping die, avoids jamming of the crimped sleeves
- Small, handy and well-balanced

For cross section mm ²	Item no.
0.5 to 16	10 1945

AE ZAE



↳ Crimping pliers FLEXI-CRIMP 6

- Cross-section range: 0.08 to 16 mm², as well as 2 x 0.5 to 2 x 10 mm²
- Lateral sleeve feed
- Hexagonal crimping for confined chamber dimensions
- Self-adjusting adaptation to the required ferrule size
- Consistently high crimp quality thanks to positive locking

For cross section mm ²	Item no.
0.08 -16 // 2 x 0,5 to 2 x 10	10 1950

AE



↳ Crimping pliers WM, DIAMANT

- Crimping pliers for wire end ferrules
- WM Pressing

For cross section mm ²	Length mm	Item no.
10 - 50 // 2 x 4 to 2 x 16	390	10 4200
50 - 95	390	10 4202



The universal crimping tool
for a wide range of applications

click 'n' crimp System



click 'n' crimp sets ↳ with crimping profile insert

SET 1 Electrical engineering
Crimping profile inserts:

10 6010, 10 6011, 10 6012 Item no.
10 6000

SET 2 Automotive
Crimping profile inserts:

10 6010, 10 6011, 10 6013 Item no.
10 6002

SET 3 Data network technology
Crimping profile inserts:















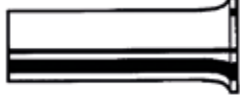

10 6015, 10 6017, 10 6019 Item no.
10 6009

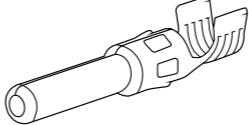
SET 4 Solar technology
Crimping profile inserts:

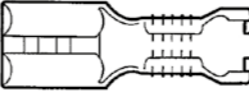
10 6010, 10 6027, 10 6028 Item no.
10 6052

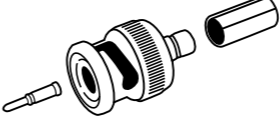
- ✓ Exchangeable inserts available
- ✓ Inserts changed without needing tools
- ✓ Space for up to 2 inserts in the handle of the pliers

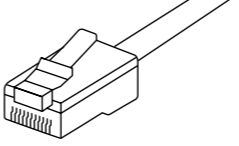
↳ click 'n' crimp crimping profile inserts

Designation	Cross section	Item no.
IS Insulated connectors (red/blue/yellow) 	 0.5 – 6 mm ²	10 6010
R Tubular cable lugs 	 0.5 – 10 mm ²	10 6011
Q Crimping cable lugs 	 0.5 – 10 mm ²	10 6011
AE Wire end ferrules 	 0.5 – 10 mm ² 16 – 35 mm ² 25 and 50 mm ²	10 6012 10 6014 10 6071
PV PV photovoltaics 	 MC 3 cross section: 2.5 – 6 mm ² MC 4 cross section: 2.5 – 6 mm ² MC 4 cross section: 2.5 – 10 mm ²	10 6027 10 6028 10 6026
FL Uninsulated blade terminals 	 0.5 – 6 mm ²	10 6013
BNC BNC/TNC coax 	 RG58, RG59, RG62AU, RG174	10 6015
NW Network 	 RJ11, RJ12 (SS, AMP) RJ45 (SS, AMP) RJ45 (CAT5)	10 6016 10 6017 10 6019

PV



↳ Crimping pliers click 'n' crimp PV MC 4

- Crimping pliers for all common MC 4 solar connectors 2.5–6 mm²
- Ratchet mechanism with automatic release for a consistently high crimp quality
- Lever transmission so little force is required
- Space to store exchangeable inserts in the handle of the pliers
- Ergonomic 2-component handle sleeves

For cross section mm ²	Item no.
2.5 - 6	10 6034



IS



↳ Crimping pliers POWER-CRIMP ISO

- For insulated connectors in the cross section range from 0.5 to 6 mm² (red, blue, yellow)
- Oval crimp
- Considerably less manual force required thanks to unique lever transmission
- Ergonomic for the hand; comfort guaranteed for a huge number of crimping operations
- Precise eccentric adjustment feature and mechanical forced locking device ensure a consistently high crimp quality

For cross section mm ²	Length mm	Item no.
0,5 - 6	270	10 7200

AE

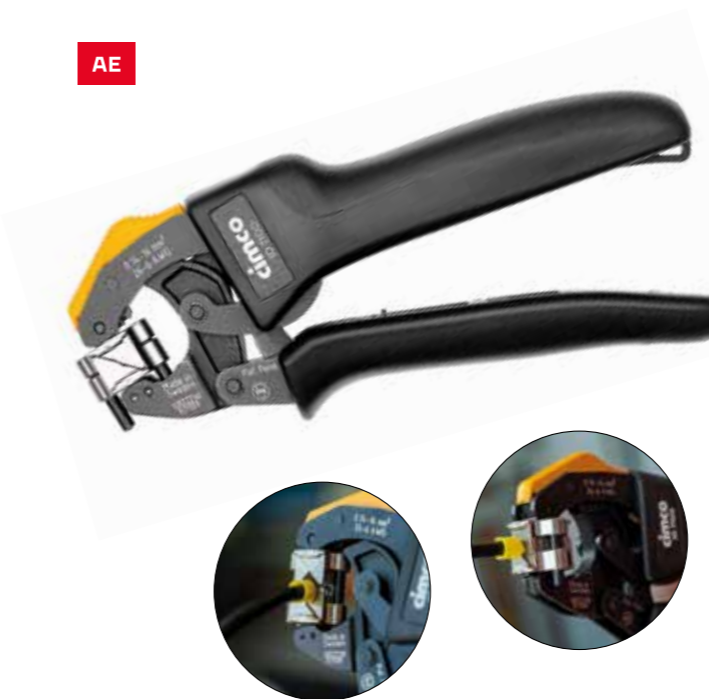

↳ Crimping pliers POWER-CRIMP TWIST

- For wire end ferrules according to DIN 46228
- Self-adjusting tool for the following cross section ranges: 0.14 to 16 mm² for single wire end ferrules and 2 x 0.5 to 2 x 6 mm² for twin wire end ferrules
- Compact tool body with small opening width ensures ergonomic handling for every crimping operation
- Non-slip handles for safe working in a variety of conditions

For cross section mm ²	Length mm	Item no.
0.14 - 16 // 2 x 0.5 to 2 x 6	180	10 7100

R



↳ Crimping pliers

- For tubular cable lugs and connectors "standard version"
- With built-in, rotatable profile discs, lever-operated
- Hex crimp

For cross section mm ²	Length mm	Item no.
6 - 50	390	10 1882
10 - 120	650	10 1880
16 - 95	530	10 1884
25 - 150	650	10 1885

D



↳ Crimping pliers

- For compression cable lugs and connectors to DIN 46235/46267
- With built-in, rotatable profile discs, lever-operated
- Hex crimp

For cross section mm ²	Length mm	Item no.
6 - 50	390	10 1883
16 - 95	650	10 1886
25 - 150	650	10 1888

R



↳ Crimping pliers WM

- For tubular cable lugs and connectors "standard version"
- Rotatable profile discs with precise cross-section allocation
- Suitable for class 2, 5 and 6 cables in accordance with IEC 60228
- Crimping profile provides optimum contact between conductors and connectors
- WM pressing

For cross section mm ²	Length mm	Item no.
6 - 50	390	10 1890
10 - 120	650	10 1891



WM pressing



Hex crimp





↳ **Universal cable sheath cutter**

- For removing all insulation layers from cables from 25 mm \varnothing
- Adjustable cutting depth of 0.5 – 5 mm
- Suitable for longitudinal and round cuts, interchangeable blade

	Item no.
> 25 mm \varnothing	12 0002



↳ **Cable sheath stripper KABIFIX**

- Suitable for slitting and stripping cables from 6 to 28 mm \varnothing
- For longitudinal and round cuts
- Also for cutting PVC pipes
- Interchangeable blade

	Item no.
6 - 28 mm \varnothing	12 0030



↳ **JOKARI Cable sheath stripper COAXI**

- For all common cables of 4.8 – 7.5 mm \varnothing
- Especially suited for coaxial cable (antenna cable)
- Incl. Socket wrench SW 11

	Item no.
4.8 - 7.5 mm \varnothing	12 0027



↳ **JOKARI Super sheath stripper**

- With round and longitudinal cutter, insulation stripping mechanism and foldaway additional blade
- Sheath stripping: cable of 8 – 13 mm \varnothing , e.g.: 7 x 1.5 mm² or 5 x 2.5 mm²
- Insulation stripping: 0.2 – 0.3 – 0.8 – 1.5 – 2.5 – 4 mm²

	Item no.
8 - 13 mm \varnothing	12 0025



↳ **JOKARI PC-STRIP insulation stripper**

- Special wire stripping tool for data and control lines, communication lines, system cables, etc.
- Sheath stripping: cable of 5 – 13 mm \varnothing
- Insulation stripping: conductors of 0.2 – 4.0 mm² or AWG 26 – 11

	Item no.
5 - 13 mm \varnothing	12 0034



↳ **JOKARI PV-Strip insulation stripper**

- For PV cables, power cables and safety cables from 2.5 to 6 mm²
- Length stop 8.5 and 15 mm, for connecting common PV plugs
- No need to adjust the blades to the cut depth
- With fixing clip

	Item no.
2.5 – 6 mm ²	12 0047



↳ **JOKARI Inside-socket sheath stripper wand**

- For all common cables of 8 – 13 mm \varnothing
- Titanium nitride coated blades guarantee the longest possible service life
- Four-blade layout reduces force required and increases precision
- Length scale
- TÜV/GS tested

	Item no.
8 - 13 mm \varnothing	12 0027



↳ **Automatic wire stripper MAXIM 6**

- For round, oval and flat cables of 0.2 – 6 mm²
- For finely wired and solid conductors with PVC insulation
- Stripping length with stop can be set from 4 to 18 mm for volume work
- No damage to the conductors due to special, self-adjusting, interchangeable segmented blades
- Integrated high-performance wire cutter

	Item no.
0.2 – 6 mm ²	10 0736



↳ **»JOKARI^{original} Automatic wire stripper SENSOR SPEZIAL**

- Specially developed for halogen-free PUR and PVC cables
- Removes without damage
- Cable types:
halogen-free sensor/actuator cables, with PUR or PVC outer sheath, 3- to 8-core cable construction, shielded or unshielded
- Round cable 4.4 to 7 mm ø

	Item no.
4.4 – 7 mm ø	10 0746



↳ **»JOKARI^{original} Automatic wire stripper SUPER 4 PRO**

- Stripping pliers for solid and flexible conductors with PVC insulation
- Automatic adjustment to the cross-section of 0.2 – 6 mm² using a special scanning system
- With adjustable longitudinal stop from 6.0 to 15.0 mm
- Sturdy, easily accessible side cutter for wires up to 2.5 mm²

	Item no.
0.2 – 6 mm ²	10 0784



↳ **Automatic wire stripper SOLAR**

- For all common solar cables, 1.5 – 10 mm²
- Precise, fine, 5-fold adjustment (can even strip the multi-layered insulation on solar cables)
- Optical length measurement from 8 to 24 mm, 5/16" to 1"
- Integrated diagonal pliers for cables up to max. 3 mm ø

	Item no.
1.5 – 10 mm ²	10 0774



Automatic wire stripper with exchangeable inserts

FLEXI-STRIP 16 System



- ✓ Fine adjustment feature for easy stripping of thin or thick cable insulation
- ✓ Self-adjusting cutting and stripping tool
- ✓ Strips the insulation without damaging the conductors

↳ Automatic wire stripper FLEXI-STRIP 16 System

- For PVC cables 0.02 to 16 mm²
- Adjustable stripping length from 3 to 18 mm
- Cutting function:
 - Flexible conductors up to 10 mm²
 - Rigid conductors up to 1.5 mm²
- Cassettes changed without needing tools (Item no. 10 7091 + 10 7092)
- Optional interchangeable insert for PTFE/PVC cables 0.1 – 4 mm² (Item no. 10 7093)

	Item no.
0.02 - 16 mm ²	10 7000



↳ JOKARI Cable stripping knife

- With hooked blade
- 2-component tool with non-slip
- Soft grip insert and thumb grip for optimal handling

	Item no.
8 – 28 mm ø	12 0010



↳ Folding cutter knife

- With quick blade change at the touch of a button
- Locking mechanism prevents unintentional opening or closing of the blade
- Includes 10 replacement trapezoid blades

	Item no.
	12 0070
10 Replacement blades for 12 0070	12 0071



↳ Automatic cutter knife, red

- With automatic blade retraction
- Integrated blade depot, tool-free blade change
- Trapezoid blade included

	Item no.
	12 0077

↳ Insertion tools for LSA-Plus terminals

- Solder, screw and stripping-free connection of conductors with 0.5 to 0.8 mm ø (AWG 24 to 20)
- Automatic trimming to insulation displacement termination in connection boxes and patch panels
- With pressure sensor for optimum pressing force, 2 pull-out hooks



	Item no.
KRONE model, pressure sensor and trimming function can be switched off	11 8018



↳ **Mast key**

- Patented, universal range of locks made of die cast zinc (GD-Zn)
- 8 mm, 9 mm, 1/4", 6 mm, 3 – 5 mm

Item no.
11 2882



↳ **Universal switch cabinet key**

- Patented, universal locking assortment made of zinc die casting
- In the center hub with heating vent locking
- For almost all common closures in electrical engineering, gas and water supply, air conditioning and much more
- Including chain, adapter and reversible bit
- 5 - 8 mm, 7, 9 mm, 1/4", 3 - 5 mm, PH 2, 1.0 x 7 mm

Item no.
11 2894



↳ **Wrench for set screws for fuses and for contact screws**

- Diazed, combined, re-insert to use for set screws 2 - 63 A
- Haft made of insulation material

Item no.
14 0102



↳ **Bit set COMFORT, 32 pieces**

- In practical storage box, incl. belt clip and hanging function
- magnetic quick-change holder (C6.3)

Professional bits with color ring for:

- slot-head screws SZ 4.5, 5.5, 6.5
- cross-head screws Phillips PH 1 / 2 x PH 2 / PH 3
- cross-head screws Pozidriv PZ 1 / 2 x PZ 2 / PZ 3
- hex socket 3.0 mm, 4.0 mm, 5.0 mm, 6.0 mm
- TX-screws size T 10, T 15, 2 x T 20, 2 x T 25, 2 x T 30, T 40
- TX-screws with bore T-Bo 10, T-Bo 15, T-Bo 20, T-Bo 25, T-Bo 27, T-Bo 30, T-Bo 40

Item no.
11 4593



↳ **Bit set SPECIAL, 33 pieces**

- Bit set for unscrewing safety screws
- With magnetic holder 60 mm for 1/4"-bit drive

Professional bits for:

- Bits for TX-screws with bore (tamper resistant) T 8 - T 10 - T 15 - T 20 - T 25 - T 27 - T 30 - T 35 - T 40
- Hex bits with bore (tamper resistant) 2 - 2.5 - 3 - 4 - 5 - 6 mm, 5/64" - 3/32" - 7/64" - 1/8" - 9/64" - 9/32"
- Slot bits with recess (spanner) 4 - 6 - 8 - 10 mm
- Tri-wing bits TW 1 - TW 2 - TW 3 - TW 4
- Torq-Set bits TS 6 - TS 8 - TS 10

Item no.
11 4599



↳ **Hex key set, 9 pieces**

- With key sizes 1.5 - 2 - 2.5 - 3 - 4 - 5 - 6 - 8 - 10 mm
- With extra long blade with ball end
- Made of fully hardened S2 special steel, polished, hard chrome-plated surface

Item no.

11 0604



↳ **Ratchet combination wrench set T120 FLEX, 5 pieces**

- In a practical roll-up bag with spanner sizes SW 8, 10, 13, 17, 19
- Ratchet spanner with 120 mm fine serration for minimum retraction angle from approx. 3°
- Open-end spanner with innovative flank geometry - makes it easy to reset the spanner without lifting it off
- Flexible ring element can be swivelled by 2 x 90°, for hard-to-reach work areas
- Made of chrome vanadium steel, specially hardened, surface finish nickel-plated matt black

Item no.

11 2550



↳ **Socket wrench set, 45 pieces**

- In attractive compact plastic box
- 6.3 mm 1/4" drive
- Hexagonal inserts for maximum torque, lever ratchet with insert quick release 72 teeth

Content:

- Hexagon inserts: 4 - 4.5 - 5 - 5.5 - 6 - 7 - 8 - 9 - 10 - 11 - 12 - 13 - 14 mm
- Cross insert PH 1 - PH 2 - PH 3 - PZ 1 - PZ 2 - PZ 3
- Slot insert 4 - 5.5 - 7 mm
- for TX-screws T 10 - T 15 - T 20 - T 25 - T 30 - T 40
- Hexagonal inserts 3 - 4 - 5 - 6 - 7 - 8 mm
- Flexible shaft 150 mm
- Extensions in 50 und 100 mm
- Cardan joint
- Handle 1/4"
- Adapter 1/4"
- Cross handle with sliding head 1/4"
- Allen wrench 1.5 - 2 - 3 mm

Item no.

11 3106



Further versions:

- Socket spanner set, 96 pieces (Item no. 11 3108)
- Socket spanner set, 171 pieces (Item no. 11 3110)



↳ **Pocket saws PUK**

- With solid, lacquered wooden haft
- Span width 150 mm

Item no.

12 0502



↳ **Bulk saw blades, 12 pieces**

- For steel, aluminium, nonferrous metals, fibre glass, plastic conduit and pipes, mineral, Rigips and fibre-cement slabs
- Tooth pitch 1.0 mm (25 teeth per inch)

Size mm

150

Item no.

12 0506



↳  **Safety cross peen hammer**

- Dimensions and finish certified according to GS. DIN 1041/1193
- With protective shaft collar and additional nylon protective shaft sleeve
- With double curved hickory shaft, hammer head double secured by tapered collar and synthetic resin seal

Weight g	Item no.
300	13 0582
500	13 0586



↳  **Safety club hammer**

- According to DIN 6475/1193
- With handle protection collar and additional nylon handle protection sleeve
- With double-welded hickory handle, hammer head doubly secured by ring wedge and synthetic resin seal

Weight g	Item no.
1,250	13 0602

↳ **Electrician's chisel**

- Made of chrome vanadium steel



Blade width mm	Steel mm	Weight g	Item no.
10	8	250	13 0006
12	8	250	13 0008
15	10	250	13 0010

↳ **Stone chisel**

- According to DIN 7254 A
- Made of chrome vanadium air-hardening steel



Blade width mm	Steel mm	Weight g	Item no.
29	23 x 13	300	13 0024



↳ **Painter's spatula**

- Made of steel, ground blade, with oval wooden haft

Width mm	Size mm	Item no.
50	205	13 1326



↳ **Plaster pan**

- Made of sheet steel, hot-dip galvanised, with polished wooden haft

Height mm	Size mm ø	Item no.
75	top 210, bottom 110	14 0302



↳ **Plaster cup**

- Made of soft rubber, easily deformable for easy handling

Height mm	Size mm ø	Item no.
90	120	14 0306



↳ **Water brush**

- Pure bristles

Size mm ø	Item no.
24	14 0310



↳ **Chalk line roller**

- With push-system
- Storage space for serrated hooks and belt clip
- cord length 15 m
- Including 60 g coloured powder







	Item no.
	14 0320
Refill powder, 100 g	14 0322

Battery-powered cutting and pressing tools

CimCut 'n' Press



- ✓ Ergonomic design, robust 2-component housing
- ✓ Motor with quick stop, automatic sleep mode
- ✓ Optimised centre of gravity allowing you to work without tiring
- ✓ High performance 18 V Li-Ion battery with fast charge
- ✓ Lockable, ergonomic activation switch
- ✓ Clear LED display for charging battery and maintenance control
- ✓ Pressure safety system for the avoidance of overpressure errors
- ✓ Energy-saving function with automatic switch-off after 10 min. (if not in use)
- ✓ Safety support ring for shoulder strap

-  100 % Purchase Security with 30 Days Money Back Guarantee
-  Every Device Includes 2 Batteries which are compatible with the charging systems of the Dewalt XR series
-  No annual service required
-  Service Cycle first after 15,000/20,000 activations
-  Optimal Illumination with LED function light
-  USB Interface for Data Analysis and Control, with read-out software to download at cimco.de



↳ CimPress 300 - Crimping head with quick release

- Crimping head can be rotated through 180°
- Interchangeable crimping inserts
- Max. processing speed thanks to high powered motor
- Automatic return after crimping completed

Crimping force	62 kN
Stroke/width of opening	13 mm
Crimping area	6 - 300 mm ²
Crimping time (dependent on cross-section)	2 - 5 s
Service cycle	20,000 activations
Working range	-10 to +60 °C
Battery voltage	18 V
Battery capacity	2.0 Ah Li-Ion
Battery charging time	40 min.

Size L x W x H mm	Weight g	Item no.
395 x 75 x 128	3.250	10 6652

↳ CimCut 85 - Guillotine-shaped cutting head

- Cutting head can be rotated through 360°
- 2-stage hydraulics for high-speed feed
- Manual return after cut completed
- Also suitable for cutting steel bars up to 20 mm ø

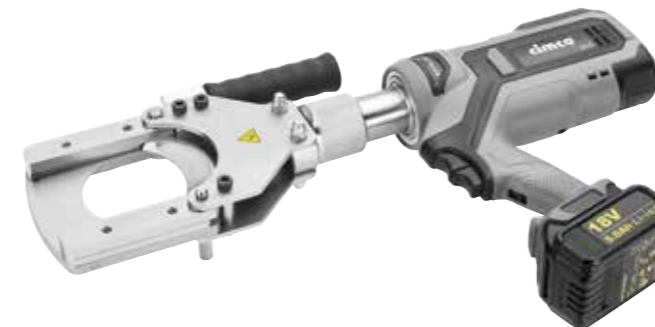

Cutting force	55 kN
For cutting	Cu/Al cable up to 85 mm ø
Max. cutting diameter	85 mm
Cutting time (dependent on cross-section)	8 - 20 s
Service cycle	20,000 activations
Working range	-10 to +60 °C
Battery voltage	18 V
Battery capacity	5.0 Ah Li-Ion
Battery charging time	60 min.

Size L x B x H mm	Weight g	Item no.
580 x 340 x 86	8.800	10 6670

↳ Crimping insert sets for tool 10 6652

- Every crimping insert set comes in a high-quality transport box

↳ WM crimping insert set, 6 pieces

- For "standard design" tubular cable lugs and connectors
- For compressed, multi-stranded or thinned-out fine stranded conductors
- Crimp width 5 mm

Content, 1 pair each:

· 70 mm ²	10 5682
· 95 mm ²	10 5684
· 120 mm ²	10 5686
· 150 mm ²	10 5688
· 185 mm ²	10 5690
· 240 mm ²	10 5692

Item no.

10 6902

↳ STANDARD crimping insert set, 6 pieces

- For "standard design" tubular cable lugs and connectors
- Crimp width 5 mm

Content, 1 pair each:

· 70 mm ²	10 5717
· 95 mm ²	10 5718
· 120 mm ²	10 5719
· 150 mm ²	10 5720
· 185 mm ²	10 5721
· 240 mm ²	10 5722

Item no.

10 6896



↳ DIN crimping insert set, 6 pieces

- For compression cable lugs and compression connectors DIN 46235/46267
- Crimp width 5 mm

Content, 1 pair each:

· 70 mm ²	Index according to DIN 16	10 5736
· 95 mm ²	Index according to DIN 18	10 5737
· 120 mm ²	Index according to DIN 20	10 5738
· 150 mm ²	Index according to DIN 22	10 5739
· 185 mm ²	Index according to DIN 25	10 5740
· 240 mm ²	Index according to DIN 28	10 5741

Item no.

10 6898



↳ ALU crimping insert set, 6 pieces

- For aluminium cable lugs and connectors DIN 46329 and similar
- Crimp width 7 mm

Content, 1 pair each:

· 50 mm ²	Index according to DIN 16	10 5787
· 70 mm ²	Index according to DIN 18	10 5788
· 95 - 120 mm ²	Index according to DIN 22	10 5789
· 150 mm ²	Index according to DIN 25	10 5790
· 185 mm ²	Index according to DIN 28	10 5791
· 240 mm ²	Index according to DIN 32	10 5792

Item no.

10 6900

Powerful battery-powered cutting tools
of the series

CimCut



- ✓ Fast and precise cutting
- ✓ Strong LED for illuminating the work area
- ✓ 18 V MAKITA battery platform
- ✓ Can also be combined with other battery platforms via adapters (Bosch, Milwaukee, Dewalt)

Accessories for CimCut series	Item no.
Battery adapter Makita platform on Bosch	10 3094
Battery adapter Makita platform on Milwaukee battery	10 3095
Battery adapter Makita platform on Stanley/Dewalt	10 3096
2 x Makita battery 18 V 5 Ah, 1 x charger	10 3097



↳ CimCut 32 F - Hydraulic cable cutter

- With open blades
- Cable cutter up to 32 mm ø, for Cu and Al wires, for fine and finest-stranded conductors (class 5 + 6)
- Head rotatable by 180°
- Lightweight and ergonomic tool for efficient work in confined spaces
- Supplied in a case, battery or adapter can be ordered separately

Size L x W x H mm	Weight g	Item no.
580 x 130 x 400	5,300	10 3004
Set with 2 x Makita battery and 1 x charger		10 3005





↳ **CimCut 50 F - Electrical cable cutter**

- With crescent-shaped blades
- Cable cutter up to 50 mm ø, for fine and finest-stranded conductors (class 5 + 6)
- Manual and automatic reverse
- With adjustable opening width for fast work
- Lightweight and ergonomic tool for efficient work in power supply and cable processing
- Battery or adapter can be ordered separately

Size L x W x H mm	Weight g	Item no.
510 x 160 x 460	5,100	10 3000
Set with 2 x Makita battery and 1 x charger		10 3001



↳ **CimCut 50 - Electrical cable cutter**

- With crescent-shaped blades
- Cable cutter up to 50 mm ø, for copper and aluminium conductors e.g. NAYY 4 x 185 mm² and copper single cores up to 630 mm²
- Manual and automatic reverse
- With adjustable opening width for fast work
- Lightweight and ergonomic tool for efficient work in power supply and cable processing
- Battery or adapter can be ordered separately

Size L x W x H mm	Weight g	Item no.
510 x 160 x 460	5,100	10 3002
Set with 2 x Makita battery and 1 x charger		10 3003



↳ HSS step drill

- Especially for screwed cable glands in electrical assembly
- Centring, drilling, drilling out and deburring in a single work stage
- Suitable for use in hand and box column drills
- For sheet metal and plate metal, profiles and tubes manufactured from steel, brass, copper, etc. up to 3 mm in thickness
- Holder shaft 12 mm ø, 12 drill steps, M 12 - 40

mm ø	Length mm	Item no.
5	110	20 1209



↳ Cutting discs MULTICUT in a can, 10 pieces

- Suitable for stainless steel, steel, and stone (in particular wall tiles)
- Special material composition makes it possible to cut metal and tiles for example without time-consuming disc replacement
- Good cutting performance and pleasant cutting behaviour
- Low-burr to burr-free edges

Design mm	Drill hole mm	Item no.
115 x 1.2	22.23	20 6844
125 x 1.2	22.23	20 6846



↳ Diamond cutting discs in a can, 3 pieces

- For concrete, exposed aggregate concrete, concrete paving stones (can be driven on), granite, sand-lime brick, slate, terrazzo, basalt, concrete (reinforced), screed, plaster, gneiss, etc.
- Effective, durable, and cost-effective, good service life
- Will impress you in daily use due to high separation speed

Design mm	Drill hole mm	Item no.
115	22.23	20 6814
125	22.23	20 6816



↳ Corundum cutting discs INOX STAINLESS STEEL

- Precise and fast cutting, extra-thin material thickness
- Extremely clean cut and low-burr, chip-free edges
- Suitable for: rust and acid-resistant steels, angular steel profiles, aluminium alloy, copper, brass and bronze, etc.

Thickness mm	Design	mm ø	Item no.
1	straight --	115	20 8910
1	straight --	125	20 8912



↳ Cutting discs STAINLESS STEEL in a can, 10 pieces

- Suitable for stainless steel
- Extra thin material thickness, precise and fast
- Extremely clean cut and low-burr, chip-free edges
- Minimal effort

Design mm	Drill hole mm	Item no.
115 x 1.0	22.23	20 6840
125 x 1.0	22.23	20 6842





↳ **ELEKTRO-TOP with edge countersink**

- Supplied in impact-resistant plastic box
- Content:
 - Hole saw each in sizes 35 mm, 68 mm, 75 mm \varnothing
 - Edge countersink for 68 mm \varnothing , with two specially-hardened cutting teeth
 - Holder shaft with two driver pins (Item no. 20 7584)
 - HSS guide drill bit, 6.35 mm \varnothing , length 70 mm
 - Push-out spring (for all saws from 52 mm \varnothing)

mm \varnothing	Item no.
68	20 7400



↳ **Hole saw \varnothing 68 mm**

- With integrated edge countersink, hexagonal holder and push-out spring
- HSS bi-metal with Vario serration
- 11 mm hexagonal holder without driver, centring drill bit 105 mm, \varnothing 6 mm, push-out spring

mm \varnothing	Item no.
68	20 7564



↳ **Hammer core bit**

- With M 16 internal thread, Hammer core bits with SDS-Plus
- Accurately ground blades soldered with silver achieve excellent durability, even when dealing with hard materials
- Ideally suited for concrete, stone, masonry, clinker brick, tiles, and lightweight construction materials
- With interchangeable centring drill

mm \varnothing	Item no.
68	20 7321
80 (82)	20 7325



↳ **Diamond core bits SOFT S**

- Working length: 65 mm
- With laser-fused diamond segments made of diamond grit bond
- Suitable for: hollow concrete block, masonry brick, tiles (soft), sand-lime brick (soft abrasive/hard), plaster and aerated concrete
- Height 8 mm

Segment Length mm	Quantity	mm \varnothing	Item no.
24	3	68	20 8770
24	4	82	20 8772



↳ **Diamond core bits STRONG S**

- Working length: 65 mm
- With laser-fused diamond segments made of diamond grit bond
- Suitable for: concrete products (medium-hard), reinforced concrete, hollow concrete block, masonry brick, tiles (hard), sand-lime brick (soft abrasive/hard/high density), etc.
- Height: 8 mm

Segment Length mm	Quantity	mm \varnothing	Item no.
24	3	68	20 8778
24	4	82	20 8780



↳ **Holder shaft 65**

- Working length: 65 mm
- Steel design
- Including ejector drift

mm \varnothing	Item no.
Hex	20 8836
SDS-Plus	20 8838



↳ **Holder shaft 65 (conical)**

- Working length: 65 mm
- for extensions with a conical holder shaft

Total length mm	Item no.
120	20 8834



↳ **Twist drill sets, HSS-R, 19 pieces**

- According to DIN 338
- In highly-stable plastic cartridge with clamping bar for each drill
- 19 Roll-milled drills 1 - 10 mm ø; increasing by 0,5 mm

Item no.
20 1352



↳ **SDS-PLUS drill bit HELIX, 5 pieces**

- 4-blades made of robust, single piece hard metal plate
- For concrete, masonry and natural stone
- Drills through reinforcing steel with permanent power and ensures precise, dimensionally accurate holes
- Center bit for easy, accurate spot drilling
- 4 x 90° geometry with specially developed blades of same height

Content:

- Drill bit-ø x Length mm
- 5 x 110, 6 x 110, 6 x 160, 8 x 160, 10 x 160

Item no.
20 8580



Rational cable pulling systems
for professional electricians.

Kati® Blitz Compact



- ✓ With Polykat® fibreglass rods
- ✓ High rod strength and thrust stability
- ✓ Optimal tool for passing through very tight bends
- ✓ Compact and handy devices
- ✓ With integrated accessory set
- ✓ Impact resistant housing



↳ Kati® Blitz Compact

- In a sturdy plastic case
- With integrated accessory set:
special gripping aid Kati® Grip, each set contains 1 guide head 7 - 10 mm ø, 3 rod ends and 2 rod ends 2.0 on the rod, 3 connecting sleeves, 5 cable lugs, 1 cable draw grip 6 - 9 mm ø, 1 fibreglass fix adhesive (3 g bottle)

	Item no.
20 m	14 2020
30 m	14 2024
50 m	14 2028

↳ Kati® Blitz Mini

- With a belt diameter of only 1,2 mm ideal for subsequent installation of already occupied empty conduits
- Minimum bending radius of only 15 mm
- Guide tube: Protects and guides the profile when pushing in
- Supplied accessories:
5 flexible guide heads M 2.5 with inside thread, 7 rod ends M 2.5 with outside thread, 1 guide tube 2.5 m with securing sleeve, 1 insulating tape 15 mm for fixing the fibre optic cable to the flexible guide head, 1 sanding pad 50 x 50 mm, 1 special adhesive 3 g

	Item no.
15 m	14 2060
25 m	14 2062
35 m	14 2064



↳ Kati® TWIST 2.0

- Lightweight, ergonomic and robust housing
- 3-fold twisted plastic pull in tapes
- Extra short rod end enables extremely tight bending radii to be passed
- With crank for time-saving unwinding and rewinding

	Item no.
20 m	14 2570
30 m	14 2571





↳ Cable coil dispenser

- For winding goods such as all types of cables as well as flexible empty conduits
- For horizontal and vertical winding and unwinding of cable coils with a minimum inner diameter of 110 mm and maximum outer diameter of 300 mm
- Quickly adjustable to different coil diameters thanks to self-locking guides
- 3 anti-slip rubber feet, carrying handle, quick winding crank handle
- Load-bearing capacity up to 70 kg

Size H x W x L mm	Item no.
570 x 460 x 400	14 2740

↳ Hand-held cable length measuring tool



- Measuring device for fast and precise determination of cable lengths
- Rubberised aluminium measuring wheel
- For all types of cables and similar wound products measuring between 4 and 35 mm in diameter

Item no.
14 2744

↳ Cable drum unroller

Extremely robust cable drum unroller made from powder-coated steel sheet complete with carrying handle and four height-adjustable, anti-slip rubber feet, flat loading ramp, with two bearer rollers and lateral drum guides.

TROMMELFIX 200
Maximum load-bearing capacity of 200 kg, maximum drum diameter of 700 mm, maximum drum width of 530 mm

Size mm	Weight kg	Item no.
120 x 600 x 635	15,7	14 2750

TROMMELFIX 700
Load-bearing capacity of up to 700 kg, maximum drum diameter of 1000 mm, maximum drum width of 730 mm

Size mm	Weight kg	Item no.
160 x 750 x 780	26	14 2752

↳ AC/DC Voltage tester 1,000 V AC/1,500 V DC



AC/DC ELECTRICITY VOLTAGE TESTER 1,000 V AC/1,500 V DC

- The all-rounder, including current measurement.



AC/DC VOLTAGE TESTER WITH FI-/RCD TRIGGER

- The professional instrument including load connection!



AC/DC VOLTAGE TESTER 1,000 V AC/1,500 V DC

- The uncompromising allrounder for every day!

Current measurement (fork) 200 A AC	✓	–	–
Load connection	–	✓	–
LCD display, illuminated	✓	✓	✓
Display	10 LEDs, 4 Digit LCD, Ton, Vibration	13 LEDs, 3 Digit LCD	13 LEDs, 3 Digit LCD
Automatic polarity display	✓	✓	✓
TrueRMS	✓	–	–
Voltage range	1 – 1,000 V AC TRMS, 1 – 1,500 V DC	12 – 1,000 V AC, 12 – 1,500 V DC	12 – 1,000 V AC, 12 – 1,500 V DC
Resistance measurement	0 – 1.00 kΩ	0 – 1.999 kΩ	–
Frequency range DC	15 – 800 Hz	40 – 400 Hz	16 – 400 Hz
Power consumption < 3.5 mA	✓	✓	✓
Single-pole test	90 – 1,000 V AC	100 – 1,000 V AC	100 – 1,000 V AC
Rotary field test 170 – 1,000 V AC	170 – 1,000 V AC	170 – 1,000 V AC	170 – 1,000 V AC
Continuity/diode test, optical and acoustic	✓	✓	✓
Fast one-hand test (shockproof socket)	✓	✓	✓
Protection class IP64	✓	✓	✓
Integrated torch	✓	✓	✓
Battery test (indication in LCD display)	✓	✓	✓
Measurement category CAT III 1000 V	✓	✓	✓
Measurement category CAT IV 600 V	✓	✓	✓
According to EN61010, EN61243-3:2014	✓	✓	✓
Batteries 2 x 1,5 V AAA	✓	✓	✓
Dimensions approx. ca.	210 x 63 x 37 mm	240 x 75 x 30 mm	240 x 65 x 19 mm
Weight approx.	270 g	270 g	180 g
Item no.	11 1439	11 1438	11 1429



↳ Non-contact voltage tester

- Non-contact, optical and acoustic detection of alternating voltages
- Overvoltage category CAT IV 1,000 V
- Two selectable voltage ranges/sensitivity levels, torch function

	Item no.
VOLTFIX	11 1460
MAGNO-VOLTFIX (from 12 V AC, additional display of magnetic field)	11 1465



↳ Digital multimeter 310 TRMS

- For professional applications in building services and industry
- Measurement category CAT III 1,000 V
- Automatic measurement range selection
- Voltage up to 1,000 V AC/DC, current up to 10 A AC/DC
- Measurement of resistance (up to 60 M Ω), frequency (up to 60 MHz), capacitance (up to 60 mF), temperature (up to 1,350°C)
- Min./max./avg., duty cycle and relative value measurement

	Item no.
	11 1402



↳ Digital Multimeter Easy TRMS

- Tested in accordance with EN61010-1
- Functions:
AC/DC voltage measurement up to 600 V, DC current measurement up to 10 A, resistance measurement up to 20 M Ω , overvoltage category CAT III 600 V, continuity test, diode test, acoustic warning signal, large LCD display, Data Hold function

Size mm	Item no.
185 x 91 x 43	11 1408

Ammeter for solar and industry
with illuminated LCD display

4100 TRMS



- ✓ Current measurement AC/DC up to 400 A
- ✓ Voltage measurement up to 1,000 V AC and 1,500 V DC
- ✓ NCV, LPF, diode test and continuity test
- ✓ Automatic switch-off, self-test

↳ Ammeter 4100 TRMS

- Measurement of resistance (up to 40 M Ω), capacitance (10 nF to 100 μ F) and frequency (up to 10 MHz)
- μ A measurement AC/DC for HVAC
- Torch, illuminated LCD display

	Item no.
	11 1418



↳ **Ammeter 3100**

- The universal measuring tool for electronics engineers
- Measurement category CAT III/1,000 V
- Current measurement AC/DC up to 400 A
- Voltage measurement up to 1,000 V AC and 1,500 V DC
- Measurement of resistance (up to 40 MΩ), capacitance (10 nF to 100 uF) and frequency (up to 10 MHz)
- Diode test and continuity test

Item no.
11 1417



↳ **AC/DC ammeter True-RMS**

- Current measurement up to 100A AC/DC,
- Functions:
With multimeter function, TrueRMS true effective value measurement, resistance and capacity measurement, overvoltage category CATII 600 V, CATIII 300V, non-contact AC-voltage measuring (NCV), Acoustic continuity test, Data-Hold, diode test, large LCD display with backlight

Size mm	Item no.
175 x 60 x 34	11 1411



↳ **Lightweight metal spirit level**

- With Plumb Site® Dual-View™ level. 2 levels (horizontal, vertical)
- With a milled surface and shock-absorbing end caps

Length mm	Item no.
400	21 1520
600	21 1522
1,000	21 1524



↳ **Socket outlet spirit level**

- The handy design enables absolutely fast and safe alignment of flush-mounted switches and sockets
- Extra strong neodymium magnet ensures easy adjustment and installation

Length mm	Item no.
100	21 1555



↳ **Digital Laser Distance Measurer FVP-30**

- Digital Laser Distance Measurer with protective cover
- Measuring range up to 30 m, accuracy: 2 mm/m
- Functions:
Beamfinder TM flip cover, Backlite LCD display, Distance, area, volume and indirect measuring (Pythagorean theorem), Dynamic (continuous) measuring, Choice of 2 reference points and 5 measuring units, Storage of the latest 20 results, Auto-Off Laser (20 sec)/device (5 min), Laser class II

Item no.
21 1563



↳ **Switch cabinet spirit level**

- Torpedo-shaped, with 3 levels which are easy to read (1 x horizontal, 1 x vertical, 1 x 45°)
- 1 magnetic V-ledge for pipes or cables as well as robust rubber end caps

Length mm	Item no.
230	21 1540



↳ **CIMCO-Construction marker**

- Functional push mechanism for automatic lead feed
- Integrated sharpener with guide
- Marker with graphite lead B2, can be refilled easily from the front and back
- For all surfaces

Item no.	
21 3150	
Pack of 12 replacement leads graphite B2	21 2152



↳ Cable ties

- Made from PA 6.6 in black or natural are the standard solution to meet practically every requirement when it comes to electrical installations
- Halogen-free, UV-stabilised (black).
- Self-extinguishing, flammability class UL 94 V-2, temperature resistance -40 °C to 85 °C.
- Certification: UL, RINA, DNV, LR, Bureau Veritas

Size mm	Item no. natural	Item no. black
2.5 x 75	18 1360	18 1860
2.5 x 100	18 1361	18 1861
2.5 x 135	18 1362	18 1862
2.5 x 160	18 1402	18 1802
2.5 x 200	18 1363	18 1863
3.5 x 140	18 1364	18 1864
3.5 x 200	18 1404	18 1804
3.5 x 280	18 1378	18 1878
4.5 x 160	18 1365	18 1865
4.5 x 180	18 1366	18 1866
4.5 x 200	18 1367	18 1867
4.5 x 250	18 1379	18 1879
4.5 x 280	18 1368	18 1868
4.5 x 360	18 1369	18 1869
4.5 x 380	18 1408	-
7.5 x 180	18 1371	18 1871
7.5 x 240	18 1372	18 1872
7.5 x 280	18 1377	18 1877
7.5 x 360	18 1373	18 1873
7.5 x 450	18 1374	18 1874
7.5 x 540	18 1375	18 1875
7.5 x 750	18 1376	18 1876
9.0 x 780	18 1390	18 1890
9.0 x 920	18 1391	18 1891
9.0 x 1,120	18 1394	18 1894
12.5 x 500	18 1392	18 1892
12.5 x 750	18 1393	18 1893
12.5 x 1,000	18 1395	18 1895



↳ Cable ties, UV-resistant

- UV-resistant cable ties made from PA 6.6 with a service life up to ten times longer than standard cable ties
- Cold-resistant to -40 °C. Ideal for use outdoors, e.g. when installing solar panels
- Self-extinguishing, flammability class: UL 94 V-2
- Temperature resistance: -40 °C to +85 °C

Size mm	Cable harness ø	Minimal tensile strength N	Item no.
3,5 x 140	3 – 36	150	18 1720
4,5 x 200	3 – 51	220	18 1722
4,5 x 280	5 – 76	220	18 1723
4,5 x 360	5 – 101	220	18 1724
7,5 x 360	5 – 101	460	18 1726

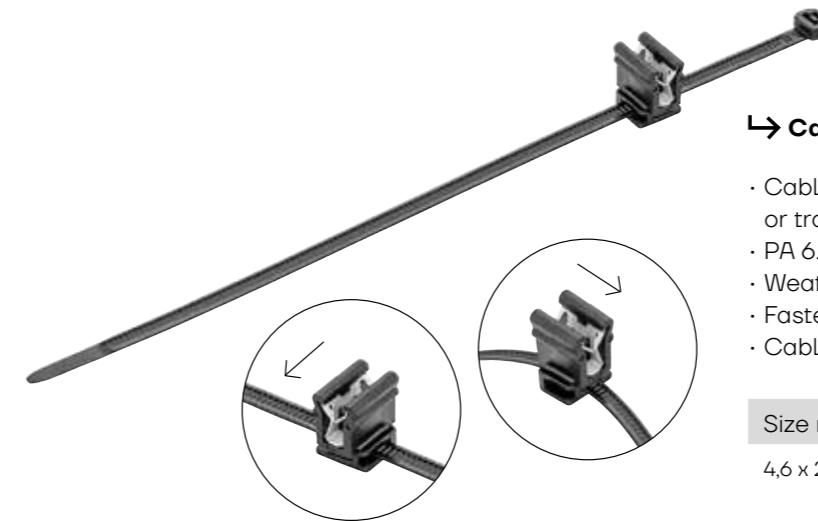

↳ Cables fastened on metal edges

- Cable tie can be inserted in the clip in the longitudinal or transverse direction
- PA 6.6, UV-stabilised
- Weather-resistant for flexible use
- Fasten quickly and without the need for tools
- Cables not damaged on sharp edges

Size mm	Bundle ø	Clamping range mm	Item no.
4,6 x 200	4 - 45	1 - 3	18 1825





↳ **Spiral bands**

- To bundle and protect cables in cable manufacturing,
- Customised lengths possible, thus no material wastage
- Re-openable and reusable.
- Made of polyethylene (PE), flame resistant, halogen-free, silicone-free
- Temperature-resistant from -20°C to +65°C,
- 1 roll = 10 m

Colour	Bundel ø mm	Coil width mm	Outer ø mm	Item no.
nature	4 - 20	7.0	6	18 6200
nature	6 - 60	11.4	10	18 6202
nature	9 - 70	13.9	12	18 6204
nature	12 - 80	15.0	15	18 6206
black	4 - 20	7.0	6	18 6220
black	6 - 60	11.4	10	18 6222
black	9 - 70	13.9	12	18 6224
black	12 - 80	15.0	15	18 6226

↳ **Hook & loop tape belt with synthetic eyelet**

- Made of woven polyamide, in two colours red/black
- Belt end without hook to open the tie quickly
- Suitable for up to 10,000 tie openings
- Tensile strength 260 N/cm, thickness approx. 2 mm



Width mm	Length mm	Item no.
25	240	18 1900
25	300	18 1902
25	360	18 1904

↳ **Our entire range of cable ties can be found on our website cimco.de**

To the cable ties





↳ Tubular cable lug sets, 255 pieces

· In a premium **CIMCO**-set box with crimping pliers

Content:

- 25 pieces 6 mm², M6 18 0694
- 25 pieces 6 mm², M8 18 0696
- 25 pieces 10 mm², M6 18 0702
- 25 pieces 10 mm², M8 18 0704
- 25 pieces 16 mm², M8 18 0712
- 25 pieces 25 mm², M8 18 0722
- 25 pieces 25 mm², M10 18 0724
- 20 pieces 35 mm², M8 18 0732
- 20 pieces 35 mm², M10 18 0734
- 20 pieces 50 mm², M10 18 0742
- 20 pieces 50 mm², M12 18 0744
- Crimping tool, 6 – 50 mm², hexagonal crimping 10 1882

Item no.

18 1545



↳ Tubular cable lug sets WM, 280 pieces

· In a premium **CIMCO**-set box with crimping pliers

Content:

- 25 pieces 6 mm², M6 18 0694
- 25 pieces 6 mm², M8 18 0696
- 25 pieces 10 mm², M6 18 0702
- 25 pieces 10 mm², M8 18 0704
- 25 pieces 16 mm², M8 18 0712
- 25 pieces 16 mm², M10 18 0714
- 25 pieces 25 mm², M8 18 0722
- 25 pieces 25 mm², M10 18 0724
- 20 pieces 35 mm², M8 18 0732
- 20 pieces 35 mm², M10 18 0734
- 20 pieces 50 mm², M10 18 0742
- 20 pieces 50 mm², M12 18 0744
- Crimping tool, 6 – 50 mm², WM crimping

Item no.

18 1548



↳ Tubular cable lug sets, 370 pieces

· In a premium **CIMCO**-set box with crimping pliers

Content:

- 50 pieces 6 mm², M5 18 3500
- 50 pieces 6 mm², M6 18 3501
- 50 pieces 10 mm², M5 18 3502
- 50 pieces 10 mm², M6 18 3503
- 25 pieces 16 mm², M8 18 3506
- 25 pieces 16 mm², M10 18 3507
- 25 pieces 25 mm², M8 18 3510
- 25 pieces 25 mm², M10 18 3511
- 20 pieces 35 mm², M8 18 3513
- 20 pieces 35 mm², M10 18 3514
- 15 pieces 50 mm², M10 18 3518
- 15 pieces 50 mm², M12 18 3519
- Crimping tool, 6 – 50 mm², hexagonal crimping 10 1883

Item no.

18 1546



The entire range of CIMCO cable lugs, individually and in sets, can be found on our website cimco.de

To the cable lugs





↳ Insulated wire end ferrule sets

· 400 pieces, sorted, in a practical dispenser, stackable

Content:

- 50 pieces 0.50 mm², 8 mm long
- 100 pieces 0.75 mm², 8 mm long
- 100 pieces 1.00 mm², 8 mm long
- 100 pieces 1.50 mm², 8 mm long
- 50 pieces 2.50 mm², 8 mm long

Colour row	Item no.
1	18 1502
2	18 1503
DIN	18 1504



· 100 pieces, sorted, in a practical dispenser, stackable

Content:

- 50 pieces 4.0 mm², 10 mm long
- 20 pieces 6.0 mm², 12 mm long
- 20 pieces 10 mm², 12 mm long
- 10 pieces 16 mm², 12 mm long

Colour row	Item no.
1	18 1505
2	18 1506
DIN	18 1507

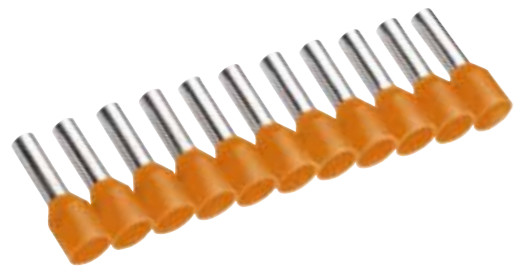

↳ ALL CIMCO ferrules, individually and in sets, can be found on our website cimco.de

To the ferrules





↳ Universal insulating tape, 10-pack

- 10 assorted colours

Width mm	Length m	Item no.
15	10	16 0000

↳ Insulating tapes for phase marking, 4 pieces

- PVC film, coated on one side with non-corrosive, pressure sensitive rubber adhesive
- Black with white print L1, L2 and L3, blue with white print N



Width mm	Length m	Item no.
15	10	16 0205

↳ Mechanical cable joint box TDM

- For fast and secure connection of communication-, control- and supply lines
- Waterproof (IP 68), UV-resistant, resistant to alkaline earths and rot
- Suitable for connecting up to four cables
- The cable joint box meets the ÖVE IM22 standard



Typ	Conductor cross section mm ² clearance	Application area ø mm	Item no.
TDM 1	3 x 1.5 to 5 x 2.5	6 - 14	18 4760
TDM 2	3 x 1.5 to 5 x 16	6 - 25	18 4762
Accessories, Spanner set TDM 2			18 4764

↳ Alpa-Gel

- Simple solution for protecting cable connections from dust and damp (IP 68).
- After the gel mass has cured, it can be removed at any time without a trace
- Solvent-free 2-component silicone gel, mixing ratio 1:1 and with a dielectric strength of 20 KV/mm



Content ml	Item no.
250	15 1010
1,000	15 1012



↳ Heat shrink tubing set „Black“, 130 pieces

- Technical data:
 Longitudinal shrinkage: < 5 %, Continuous temperature: -55 to 125°C, Shrink temperature: 125°C, Dielectric strength: 15 kV/mm (IEC243), Volume resistivity: 1014 Ohm x cm (IEC93), Tensile strength: 10,4 MPa (ASTM D2671), Elongation at break: 200 % (ASTM D2671)

- Content:
- 30 pieces, 35 mm long, ø before/after 1.5/0.7 mm 18 1681
 - 25 pieces, 35 mm long, ø before/after 2.5/1.0 mm 18 1682
 - 20 pieces, 35 mm long, ø before/after 3.5/1.5 mm 18 1683
 - 20 pieces, 35 mm long, ø before/after 5.0/2.3 mm 18 1684
 - 15 pieces, 70 mm long, ø before/after 6.5/3.0 mm 18 1685
 - 10 pieces, 70 mm long, ø before/after 9.5/4.5 mm 18 1686
 - 10 pieces, 70 mm long, ø before/after 12.5/6.0 mm 18 1687

Item no.
18 1680



↳ Heat shrink tubing set „Colour“, 110 pieces

- Technical data:
 Longitudinal shrinkage: < 5 %, Continuous temperature: -55 to 125°C, Shrink temperature: 125°C, Dielectric strength: 15 kV/mm (IEC243), Volume resistivity: 1014 Ohm x cm (IEC93), Tensile strength: 10,4 MPa (ASTM D2671), Elongation at break: 200 % (ASTM D2671)

- Content:
- 20 pieces, 35 mm long, ø before/after 3.5/1.5 mm 18 1691
 - 10 pieces, 35 mm long, ø before/after 5.0/2.3 mm 18 1692
 - 10 pieces, 35 mm long, ø before/after 5.0/2.3 mm 18 1693
 - 10 pieces, 35 mm long, ø before/after 5.0/2.3 mm 18 1694
 - 10 pieces, 70 mm long, ø before/after 9.5/4.5 mm 18 1695
 - 10 pieces, 70 mm long, ø before/after 9.5/4.5 mm 18 1696
 - 20 pieces, 70 mm long, ø before/after 9.5/4.5 mm 18 1697
 - 20 pieces, 70 mm long, ø before/after 12.5/6.0 mm 18 1698

Item no.
18 1690



↳ **Silicone spray**

- Ideal lubricant, protective agent, maintenance agent and separating agent
- Makes the winding of cables easier
- protects electric contacts against moisture
- Protects rubber, plastic and metal parts
- Only handle when in a de-energised state

Content ml	Item no.
400	15 1004



↳ **Rust remover and contact spray**

- Corrosion protection, cleaning, lubrication, water displacement and conservation in a single product
- Removes rust, displaces water from ignition contacts and electrical lines, provides sustainable protection against corrosion and greases sliding surfaces
- Prevents creep currents, sparks and short circuits

Content ml	Item no.
400	15 1040



↳ **Freeze spray**

- For thermal troubleshooting and the quickest functional testing of electrical components, thermostats, ignition- and control units
- For the cooling of motor parts and heat-sensitive compo, cools locally to -45°
- Suitable for all materials (excluding plastics), highly flammable.

Content ml	Item no.
400	15 1090



↳ **Zinc spray**

- Durable, quick-drying cathodic corrosion protection with long-term effect for all metal surfaces
- Resistant to salt, water and heat up to approx. 500°C
- Suitable for the improvement of damaged zinc coatings

Content ml	Colour	Item no.
400	white aluminium	15 1100
400	light	15 1102



↳ **Assembly adhesive**

- For the quick, universal bonding of metals, various plastics, concrete, marble, natural and artificial stone, ceramics, enamel, plaster as well as MDF board, wooden board, chipboard, fibreboard and plasterboard
- Silicone and solvent free and can be coated/painted over ("wet on wet")

Content ml	Colour	Item no.
310	white	15 1154



↳ **Universal instant adhesive**

- Solvent-free and cold-setting cyanoacrylate adhesive that hardens under pressure.

Content g	Item no.
20	15 1200



↳ **Silicone**

- 1 component adhesive and sealant
- bonds to the majority of substrates, such as aluminium, steel, glass, glass fabric, ceramic, plastic, wood and many other materials.

Content ml	Colour	Item no.
310	transparent	15 1260
310	white	15 1262
310	grey	15 1264



↳ **Cartridge gun**

- For all standard cartridges (e.g. silicone)
- Open skeleton structure, soft delivery stroke
- Extremely long service life

Item no.
15 1270



↳ LED Flex Battery

- Site light for 18V battery systems
- Luminous flux 500 – 2,000 lm, 3 dimmer steps available
- Mounting options: Stand, tripod, hanging
- SOS flash function
- Works with Bosch and Makita 18 V batteries (battery not included with product)
- Adapter for BOSCH battery included in contents

Dimensions mm	Item no.
240 x 230 x 270	11 1550



↳ LED Pro 1500

- Compact design, dimensions W x D x H: 128 x 45 x 100 mm
- Luminous flux 300 – 1,500 lm, 4 dimmer steps
- Shockproof, dustproof and splashproof (IK07, IP54)
- Shock resistant, dustproof and splashproof (IK07, IP54)
- Mounting methods: Stand, magnet, hook, tripod
- Housing rotatable by 360° for perfect directionality
- USB-C connection (charging cable included)
- USB output for power bank function

Dimensions mm	Item no.
128 x 45 x 100	11 1572



↳ LED Pro Pocket

- The allrounder for your trouser pocket
- Two lamp functions: torch and work light, work light is steplessly dimmable.
- The strong magnet ensures a firm connection to metal surfaces
- Aluminium housing: shock-resistant, dustproof and splashproof (IK07, IP54)
- Easy to find in dark environments thanks to fluorescent reflector
- USB-C connection (charging cable included)

Dimensions mm	Item no.
45 x 40 x 120	11 1575



↳ Multi-purpose screws

- Chipboard screws, galvanised, round head (pan head) with Pozidriv cross-head



ø mm	Length mm	for PZ	Item no.
3.5	16	2	19 0088
3.5	20	2	19 0089
3.5	25	2	19 0090
3.5	30	2	19 0091
3.5	35	2	19 0092
3.5	40	2	19 0093
4.0	20	2	19 0098
4.0	25	2	19 0099
4.0	30	2	19 0100
4.0	35	2	19 0101
4.0	40	2	19 0102
4.0	45	2	19 0103
4.0	50	2	19 0104
4.5	25	2	19 0108
4.5	30	2	19 0109
4.5	35	2	19 0110
4.5	40	2	19 0111
4.5	45	2	19 0112
4.5	50	2	19 0113
5.0	30	2	19 0118
5.0	35	2	19 0119
5.0	40	2	19 0120
5.0	50	2	19 0121
5.0	60	2	19 0122
6.0	60	3	19 0126

To the screws



↳ The complete screw program can be found on our website cimco.de



↳ Test sticker “Electrically tested”

- Material: standard film
- Supplied in booklet with 108 stickers
- Format d = 30 mm

Year	Item no.
2024	18 2794

↳ Fire safety notices

- DIN 4066, VDE AR 2100-712
- Film, self-adhesive
- White/Signal red (RAL 3001)
- Size 105 x 148 mm

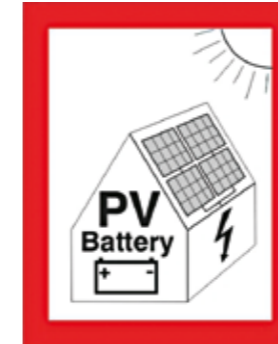

Item no.	
Indicates a PV system with battery storage	18 2798



Item no.	
Indicates a PV system	18 2799



To the labels



↳ You can find all inspection stickers and labels from the CIMCO range on our website cimco.de

CIMCO-CLUB

The club for electronics engineers



Get yourselves a

LIFETIME WARRANTY*

for your quality tools



Lifetime warranty*
on your screwdrivers, pliers and
hand crimping pliers from CIMCO.



Exclusive Newsletter
with special offers
and discounts.

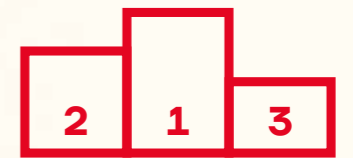

**Regularly attractive
competitions** for
CIMCO Club members.



Register now!
www.cimco.club

* For full details of CIMCO's free club registration and lifetime warranty, please visit www.cimco.club/richtlinien



Dieses Druckerzeugnis ist mit dem Blauen Engel hergestellt.
This printed product has been produced with the Blue Angel.



CIMCO Werkzeuge GmbH & Co. KG
Hohenhagener Straße 1 – 5
42855 Remscheid

+49 (0) 2191 3718-01
info@cimco.de
cimco.de



Technical modifications, colour deviations, errors and misprints reserved.
Offer only valid while stocks last. Sale only via specialist wholesalers.