

ZG1 Monitor Arm

iotspot

PEGGY

USB-C

INTUBLU



Independent Systems

PRIMO 2

# Innovation catalogue **2020**

WE  
**power**  
YOUR LIFE.



In the field of electrical engineering, BACHMANN is well positioned for numerous areas of application, for which I am thankful. We are always delighted to make the shortlist whenever customers are looking for quality, attractive design and innovative solutions. For me, product attributes are just one part of what we offer – it is at least equally important to ensure that every product reflects our values. These are values that we put into practice every day.

**Future Viability** is a constant source of motivation for us. We aim to surpass your expectations and those of your customers by incorporating superior added value into our products – and increasingly into the systems and platforms of the future.

**Passion** is plain to see in our products. Each and every day, our highly motivated colleagues invest their inspiration and expertise in expanding and advancing the BACHMANN portfolio.

**Trust** is the foundation on which new and decades-long customer relationships are based – and also an important sign of quality in our collaborations.

**Authentic You** and **Respect** nicely summarise our overarching goal of giving you and your customers a feeling of true appreciation and a little more 'Life Quality' with each day that passes.

In this catalogue, we are delighted to present new takes on our classic products alongside innovations from BACHMANN. On that note, we wish you success with your business in every sense.

**Peter Bachmann | CEO**

About  
BACHMANN

**BACH  
MANN**

 **HOME**

**70** years of  
experience

in developing, manufacturing and  
distributing high-quality power  
distribution solutions

**WE  
power  
YOUR LIFE.**

BASED IN  **STUTT GART**

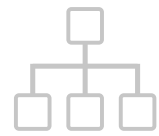

IT INFRASTRUCTURE

Over **2000**  
standard products

  
**1947**  
Year founded

AROUND **30**  
**TRADING PARTNERS  
WORLDWIDE**

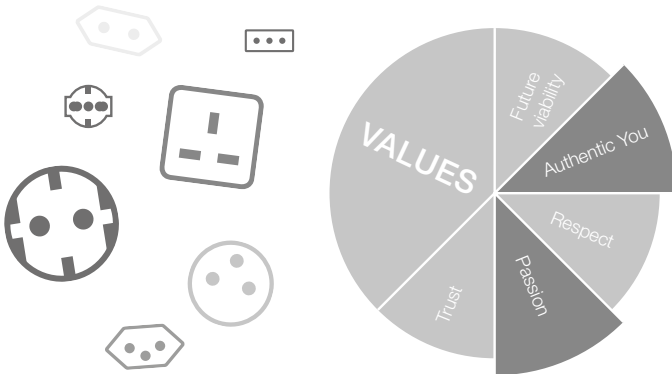

AROUND  
**800**  
EMPLOYEES  
WORLDWIDE



OFFICE A



 **HOTEL**

## Research & development

- Company-owned sites in Germany and China
- Company-owned labs for conducting function and safety tests
- Certification in line with the strictest standards (e.g. DIN EN ISO 9001)
- Strong development network with external partners



## Sales channels

- Subsidiaries:
  - BACHMANN Romania S.R.L. (Medias, Romania)
  - BACHMANN Hong Kong Ltd. (Hong Kong, China)
  - BACHMANN S.A.R.L. (Tremblay, France)
  - BACHMANN Electrical Engineering Ltd. (Milton Keynes, UK)
  - BACHMANN S.A. (Barcelona, Spain)
- International agents:
  - Albania, Austria, Belgium, Bosnia and Herzegovina, Bulgaria, Croatia, Czechia, Denmark, Estonia, Finland, Greece, Hungary, Ireland, Italy, Latvia, Lithuania, Luxembourg, Macedonia, Montenegro, Netherlands, Norway, Poland, Portugal, Russia, Serbia, Slovakia, Slovenia, Sweden, Switzerland, Ukraine, United Kingdom
- Close partnership with electrical wholesalers
- Key account managers
- Customised OEM solutions
- Individual project solutions

For details of all **contacts**, see page 46.

## Production

- Production sites in Germany, Romania and China
- 100% function testing in production



Our German production site in Gumpelstadt, Thuringia.

# Technologies and function modules

BACHMANN products are distinguished by their functionality and high technical standards. It is important to us that we tailor our products as specifically as possible to you. To this end, in addition to the standard functionalities, our products can also be configured with the technologies and function modules presented in this catalogue.

We aim to satisfy your individual requirements as best we can.

Are you unable to find a particular functionality, or you would like to ask something else? Please contact us for an individual quotation!

---

## Surge protection

These days, the failure of electrical and electronic devices is a real nightmare scenario. Protecting such devices from excess electrical voltage is therefore a key task. Here, the BACHMANN strips with built-in surge protection are the ideal solution.

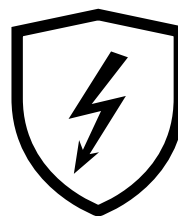

---

## Mains and frequency filters

Mains and frequency filters ensure effective screening and smoothing of the input voltage. Only 'clean' voltage gets through our mains and frequency filters. Voltage stabilisation and the filtering-out of disturbance frequencies enables the connected device to run correctly and faultlessly.

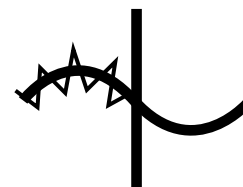

---

## Residual current devices/miniature circuit breakers

The residual current device/miniature circuit breaker integrated into a BACHMANN strip gives you peace of mind. You can choose between the two circuit breakers; a combination of the two is also possible, of course.

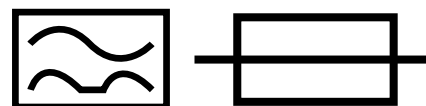

---

## Anti-theft bracket

The anti-theft bracket is fitted permanently in the product and enables a Kensington lock to be affixed: anti-theft protection for mobile hardware such as laptops, desktop PCs, projectors, LCD screens, tablets, etc.

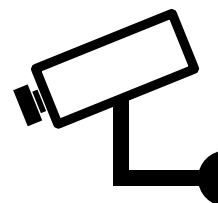

### iotspot

With iotspot integrated into a BACHMANN design connection panel, such as the DESK 2, it is quick and easy to search for, find and reserve workstations. Not only that: facility managers will receive detailed data and analyses on workplace utilisation and therefore also valuable knowledge with a view to cost optimisation.



---

### USB chargers (fixed installations and Custom Modules)

USB chargers from BACHMANN are able to supply all standardised voltage profiles to the load. Power Delivery and Qualcomm enable fast, intelligent charging. Furthermore, the chargers feature integrated current limitation and protection against excessive temperatures. Their compact design means that they can be integrated into all conventional BACHMANN products.

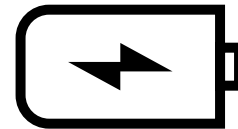

---

### USB 3.0 Hub

The USB 3.0 Hub is an active USB component. It has a plug mains adapter that supplies the connected USB devices with voltage.



---

### Data switch

Small, compact and easy to integrate into BACHMANN power strips: the high-speed network data switch provides PoE (Power over Ethernet) for selected devices.



# Information on the page structure

## FINDING YOUR WAY AROUND

The new catalogue structure features three levels: product family, product category and product variant.

## PRODUCT DETAILS

The body text contains all central information such as product name, special product features, areas of use, benefits and – if applicable – design awards.

## PRODUCT ATTRIBUTES

All the technical attributes of a product are shown together in the bottom left of the page and are marked using a gear symbol.

● Network and media technology | Custom Modules



## ● USB-A&C Custom Module

The new, space-saving 22 W Custom Module uniquely combines a USB-A and USB-C port. It is ideal for charging common smartphones and tablets as well as many other electrical devices with USB-A or the latest USB-C technology – without cumbersome external mains adapters. Thanks to the integrated USB Power Delivery (PD) and Qualcomm® Quick Charge™, fast charging is no longer a problem.

Quick and flexible in use: the new module is ideal for retrofitting and upgrading existing installations.

### BENEFITS

- **USB-A and USB-C in one**
- **Latest USB-C charging technology**
- **Ideal for retrofitting and upgrades**
- **Fast charging via PD and QC**
- **Integrated current limitation and overheating protection**



Material: Plastic

Colour variants: ■



**USB charger Custom Module**

#	
<b>USB-A&amp;C 22 W Custom Module</b>	
917.227	Front side: 1x USB-A socket, 1x USB-C socket   Back side: GST18B3 plug with approx. 0.2m cable   Black

**Accessories**

#	
<b>GST18/earthing contact plug</b>	
Cable: HD5VV-F 3G 1.50mm <sup>2</sup>   End 1: Right-angled plug with earthing contact   End 2: Wieland GST18B3 socket	
375.075	2.0m   Black
<b>GST18/Swiss plug</b>	
Cable: HD5VV-F 3G 1.00mm <sup>2</sup>   End 1: CH/Swiss plug   End 2: Wieland GST18B3 socket	
375.017	3.0m   Black
<b>GST18/13 A UK plug</b>	
Cable: HD5VV-F 3G 1.50mm <sup>2</sup>   End 1: 13 A UK plug   End 2: Wieland GST18B3 socket	
375.068	2.0m   Black
<b>Multiplier, GST18i</b>	
For power forwarding   Input: 3-pole plug section   Output: 3-pole socket section	
375.107	1x input, 2x output (1)   Black
375.102	1x input, 2x output (2)   Black
<b>USB 3.1 Gen2 Type C cable</b>	
918.190	0.5m   Black



**PRODUCT TABLES**

Here, you will find product-specific information such as item number, version, colour, sockets, etc. for all product versions.



**Flexible in integration**  
Can be used easily and without difficulty in all BACHMANN desk connection panels with Custom Module mount.

**ADDITIONAL PRODUCT INFORMATION**

Below or above the product tables, you will find more information about the product and installation drawings.

You will find matching desk connection panels in the 2019 edition of the complete catalogue.

**COMPATIBLE ADDITIONAL PRODUCTS**

All information and page references to compatible additional products can be found in the bottom right of the page.

Pictograms and their meanings can be found on page 51.

www.bachmann.com 25

**PICTOGRAMS AND THEIR MEANINGS**

Here, you will find details of the relevant page for an in-depth explanation of the pictograms (symbols) used.

**Our product  
innovations**

<b>PRIMO 2</b>	12
<hr/>	
<b>USB-A&amp;C and USB-C</b>	14
DESK	16
DESK 2	17
DESK RAIL	20
DESK 2 ALU BLACK	21
POWER FRAME	22
CONI	23
<hr/>	
<b>USB-A&amp;C Custom Module</b>	24
<hr/>	
<b>USB 3.1 Type C keystone</b>	26
<hr/>	
<b>INTUBLU</b>	28
<hr/>	
<b>iotspot</b>	30
<hr/>	
<b>Independent Systems</b>	32
Independent Monitor	32
Independent Workplace	36
<hr/>	
<b>ZG1 Monitor Arm</b>	38
<hr/>	
<b>PEGGY</b>	42
<hr/>	
<b>Accessories</b>	44



# PRIMO 2

In addition to its high-quality materials and handy features, PRIMO 2 is distinguished by its contemporary design. Variable, screwless end caps lend an air of assured style. At the same time, the cable rewind helps with tidiness, while an optional design strap ensures maximum flexibility. Whether suspended horizontally, screwed on or hanging up – the PRIMO 2 is attractive and the perfect choice of power distribution for any contemporary office or home.

Function meets design: the PRIMO 2 impresses with its new technical, application-specific and user-oriented variants. For example, surge protection, a USB-A and C charger or a classic residual-current device can all be custom-integrated.

## BENEFITS

- **Screwless end caps**
- **Concealed mounting possible**
- **Tidier with cable rewind**
- **Optional suspension strap**
- **Sleek, appealing design**

## AWARDS

**DESIGN PLUS**  
powered by: **light+building**  
2020



**Material:** Plastic and aluminium



**Socket colour:** Black

**Colour variants:**

**PRIMO 2**

#							
---	--	--	--	--	--	--	--

**Socket outlet with earthing contact** | Supply cable: 2.0 m H05VV-F 3G 1.50 mm<sup>2</sup> with right-angled plug with earthing contact

350.000	6	35°					
350.001	6	35°	●				
350.002	6	35°	●	●			
350.003	6	35°		●			
350.004	6	35°	●	●	●		
350.005	6	35°				●	
350.006	3	35°	●				
350.007	3	35°					
350.008	3	35°					A/C 22W



350.006

#							
---	--	--	--	--	--	--	--

**UK** | Supply cable: 2.0 m H05VV-F 3G 1.50 mm<sup>2</sup> with UK plug

350.030	6	45°	●				
350.031	6	45°					
350.032	3	45°					
350.033	3	45°	●				



350.007

#							
---	--	--	--	--	--	--	--

**UTE** | Supply cable: 2.0 m H05VV-F 3G 1.50 mm<sup>2</sup> with right-angled plug with earthing contact

350.050	6	35°	●				
350.051	6	35°					
350.052	3	35°					
350.053	3	35°	●				



350.000

#							
---	--	--	--	--	--	--	--

**Swiss socket** | Supply cable: 2.0 m H05VV-F 3G 1.50 mm<sup>2</sup> with Swiss plug

350.070	6	90°	●				
350.071	6	90°					
350.072	3	90°					
350.073	3	90°	●				



350.001

#							
---	--	--	--	--	--	--	--

**P40** | Supply cable: 2.0 m H05VV-F 3G 1.50 mm<sup>2</sup> with right-angled plug with earthing contact

350.080	6	35°	●				
350.081	6	35°					
350.082	3	35°					
350.083	3	35°	●				



350.003



350.002

#	
---	--

**Accessories**

350.100	End caps with cable rewind   Black
---------	------------------------------------

Further configurations available upon request.



# USB-A&C and USB-C

The new way to charge: the new USB-A&C and USB-C charging modules from BACHMANN provide the ideal solution for any application. With the innovative charging technology, any electronic device can be charged quickly and safely without an external mains adapter. Thanks to the integrated USB Power Delivery (PD) and Qualcomm® Quick Charge™ (QC), fast charging is just one of the many benefits.

The USB-A&C 22 W combi-module is the ideal solution for low- and medium-powered devices, such as common smartphones and tablets. The USB-C 30 W module can be used to charge medium-powered devices and small notebooks. With help from the USB-C 60 W module, a wide range of common electrical devices and powerful notebooks are also covered.

## BENEFITS

- **Latest USB-C charging technology**
- **Fast charging via PD and QC**
- **Integrated current limitation**
- **Overheating protection**
- **Available in a wide range of products**



**Material:** Aluminium | Plastic

**Socket colour:** Black

**Colour variants:**



### USB-C 60 W

For all common devices such as smartphones, tablets and laptops



### USB-C 30 W

For all common devices such as smartphones, tablets and smaller laptops



### USB-A&C 22 W

For all common devices such as smartphones and tablets



### For the perfect connection – USB 3.1 Gen2 Type C cable

· Black

#	
918.190	0,5m cable



Additional configurations are available for KAPSA, CONNECT LINE, CRAFTSMAN SOCKET OUTLET, PRIMO and UNIVERSAL.

# DESK



## DESK

#						
---	--	--	--	--	--	--

**Without device supply cable** | Power input: GST18 | Power output: GST18 | Silver/aluminium

902.0811	2				35°	A/C 22W	
902.0812	2				35°	C 30W	
902.0813	2				35°	C 60W	
902.0814	2				35°	A/C 22W	1
902.0815	2				35°	C 30W	1
902.0816	2				35°	C 60W	1
902.0851		2			45°	A/C 22W	
902.0852		2			45°	C 30W	
902.0853		2			45°	C 60W	
902.0854		2			45°	A/C 22W	1
902.0855		2			45°	C 30W	1
902.0856		2			45°	C 60W	1
902.0871			2		35°	A/C 22W	
902.0872			2		35°	C 30W	
902.0873			2		35°	C 60W	
902.0874			2		35°	A/C 22W	
902.0875			2		35°	C 30W	1
902.0876			2		35°	C 60W	1
902.0821				2	0°	A/C 22W	
902.0822				2	90°	C 30W	
902.0823				2	90°	C 60W	
902.0824				2	90°	A/C 22W	1
902.0825				2	90°	C 30W	1
902.0826				2	90°	C 60W	1



902.0813



902.0815



902.0851



902.0872



902.0875

You will find the matching **device supply cables and Custom Modules** in the 2019 edition of the complete catalogue.



# DESK 2



## DESK 2

#	⚡	⚡	⚡	USB-A	USB-C	↻	🔌	Ⓜ
---	---	---	---	-------	-------	---	---	---

**Without device supply cable** | Power input: 0.2m with GST18 | Including mounting bracket | Black

902.962	2							35°	A/C 22W	
902.963	2							35°	C 30W	
902.964	2							35°	C 60W	
902.965	2							35°	A/C 22W	1
902.966	2							35°	C 30W	1
902.967	2							35°	C 60W	1
902.974		2						45°	A/C 22W	
902.975		2						45°	C 30W	
902.976		2						45°	C 60W	
902.977		2						45°	A/C 22W	
902.978		2						45°	C 30W	1
902.979		2						45°	C 60W	1
902.980			2					35°	A/C 22W	
902.981			2					35°	C 30W	
902.982			2					35°	C 60W	
902.983			2					35°	A/C 22W	1
902.984			2					35°	C 30W	1
902.985			2					35°	C 60W	1
902.968				2				90°	A/C 22W	
902.969				2				90°	C 30W	
902.970				2				90°	C 60W	
902.971				2				90°	A/C 22W	1
902.972				2				90°	C 30W	1
902.973				2				90°	C 60W	1
902.986					2			35°	A/C 22W	
902.987					2			35°	C 30W	
902.988					2			35°	C 60W	
902.989					2			35°	A/C 22W	1
902.990					2			35°	C 30W	1
902.991					2			35°	C 60W	1



You will find the matching **device supply cables and Custom Modules** in the 2019 edition of the complete catalogue.



## DESK 2

#								
---	--	--	--	--	--	--	--	--

**Without device supply cable** | Power input: 0.2m with GST18 | Including mounting bracket | White

902.932	2					35°	A/C 22W	
902.933	2					35°	C 30W	
902.934	2					35°	C 60W	
902.935	2					35°	A/C 22W	1
902.936	2					35°	C 30W	1
902.937	2					35°	C 60W	1
902.944		2				90°	A/C 22W	
902.945		2				90°	C 30W	
902.946		2				45°	C 60W	
902.947		2				45°	A/C 22W	1
902.948		2				45°	C 30W	1
902.949		2				45°	C 60W	1
902.950			2			35°	A/C 22W	
902.951			2			35°	C 30W	
902.952			2			35°	C 60W	
902.953			2			35°	A/C 22W	1
902.954			2			35°	C 30W	1
902.955			2			35°	C 60W	1
902.938				2		90°	A/C 22W	
902.939				2		90°	C 30W	
902.940				2		90°	C 60W	
902.941				2		90°	A/C 22W	1
902.942				2		90°	C 30W	1
902.943				2		90°	C 60W	1
902.956					2	35°	A/C 22W	
902.957					2	35°	C 30W	
902.958					2	35°	C 60W	
902.959					2	35°	A/C 22W	1
902.960					2	35°	C 30W	1
902.961					2	35°	C 60W	1



902.934



902.935



902.945



902.953

You will find the matching **device supply cables and Custom Modules** in the 2019 edition of the complete catalogue.



## DESK 2

#									
<b>Without device supply cable</b>   Power input: 0.2m with GST18   Including mounting bracket   Stainless steel									
902.901	2						35°	A/C 22W	
902.902	2						35°	C 30W	
902.903	2						35°	C 60W	
902.904	2						35°	A/C 22W	1
902.905	2						35°	C 30W	1
902.906	2						35°	C 60W	1
902.913		2					90°	A/C 22W	
902.914		2					90°	C 30W	
902.915		2					45°	C 60W	
902.917		2					45°	A/C 22W	1
902.918		2					45°	C 30W	
902.919		2					45°	C 60W	1
902.920			2				35°	A/C 22W	
902.921			2				35°	C 30W	
902.922			2				35°	C 60W	
902.923			2				35°	A/C 22W	1
902.924			2				35°	C 30W	1
902.925			2				35°	C 60W	1
902.907				2			90°	A/C 22W	
902.908				2			90°	C 30W	
902.909				2			90°	C 60W	
902.910				2			90°	A/C 22W	1
902.911				2			90°	C 30W	1
902.912				2			90°	C 60W	1
902.926					2		35°	A/C 22W	
902.927					2		35°	C 30W	
902.928					2		35°	C 60W	
902.929					2		35°	A/C 22W	1
902.930					2		35°	C 30W	1
902.931					2		35°	C 60W	1



902.901



902.902



902.907



902.911

You will find the matching **device supply cables and Custom Modules** in the 2019 edition of the complete catalogue.

# DESK RAIL



## DESK RAIL

- Profile colour: Grey
- End-cap colour: Black
- Compatible with the following railing systems: BENE, NOVUS, K&N, Steelcase, VS, etc.

#									
---	--	--	--	--	--	--	--	--	--

**Without device supply cable** | Power input: 2.0m with GST18 | Silver/aluminium

941.301	2								35°	A/C 22W	
941.302	2								35°	C 30W	
941.303	2								35°	C 60W	
941.304	2								35°	A/C 22W	1
941.305	2								35°	C 30W	1
941.306	2								35°	C 60W	1
941.313		2							45°	A/C 22W	
941.314		2							45°	C 30W	
941.315		2							45°	C 60W	
941.316		2							45°	A/C 22W	1
941.317		2							45°	C 30W	1
941.318		2							45°	C 60W	1
941.319			2						35°	A/C 22W	
941.320			2						35°	C 30W	
941.321			2						35°	C 60W	
941.322			2						35°	A/C 22W	1
941.323			2						35°	C 30W	1
941.324			2						35°	C 60W	1
941.307				2					90°	A/C 22W	
941.308				2					90°	C 30W	
941.309				2					90°	C 60W	
941.310				2					90°	A/C 22W	1
941.311				2					90°	C 30W	1
941.312				2					90°	C 60W	1
941.325					2				35°	A/C 22W	
941.326					2				35°	C 30W	
941.327					2				35°	C 60W	
941.328					2				35°	A/C 22W	1
941.329					2				35°	C 30W	1
941.330					2				35°	C 60W	1



You will find the matching **device supply cables and Custom Modules** in the 2019 edition of the complete catalogue.

# DESK 2 ALU BLACK



## DESK 2 ALU BLACK

- Profile colour: Grey
- End-cap colour: Black

#								
---	--	--	--	--	--	--	--	--

**Without device supply cable** | Power input: 0.2m with GST18 | including mounting bracket | Silver/aluminium

937.301	2					35°	A/C 22W	
937.302	2					35°	C 30W	
937.303	2					35°	C 60W	
937.304	2					35°	A/C 22W	1
937.305	2					35°	C 30W	1
937.306	2					35°	C 60W	1
937.313		2				45°	A/C 22W	
937.314		2				45°	C 30W	
937.315		2				45°	C 60W	
937.316		2				45°	A/C 22W	1
937.317		2				45°	C 30W	1
937.318		2				45°	C 60W	1
937.319			2			35°	A/C 22W	
937.320			2			35°	C 30W	
937.321			2			35°	C 60W	
937.322			2			35°	A/C 22W	1
937.323			2			35°	C 30W	1
937.324			2			35°	C 60W	1
937.307				2		90°	A/C 22W	
937.308				2		90°	C 30W	
937.309				2		90°	C 60W	
937.310				2		90°	A/C 22W	1
937.311				2		90°	C 30W	1
937.312				2		90°	C 60W	1
937.325					2	35°	A/C 22W	
937.326					2	35°	C 30W	
937.327					2	35°	C 60W	
937.328					2	35°	A/C 22W	1
937.329					2	35°	C 30W	1
937.330					2	35°	C 60W	1



937.302



937.304



937.310



937.314



937.323



937.325

You will find the matching **device supply cables and Custom Modules** in the 2019 edition of the complete catalogue.

# POWER FRAME



## POWER FRAME

#															
---	--	--	--	--	--	--	--	--	--	--	--	--	--	--	--

### Silver | Aluminium

916.502	3							35°				A/C 22W			
916.506	3							35°				C 30W			
916.501	2							35°				A/C 22W			
916.504	2							35°				A/C 22W		1	
916.507	2							35°				C 30W		1	
916.508	2							35°				C 60W		2	
916.503	1							35°				A/C 22W		1	
916.505	1							35°				C 30W		1	
916.518		3						90°				A/C 22W			
916.522		3						90°				C 30W			
916.517		2						90°				A/C 22W			
916.520		2						90°				A/C 22W		1	
916.523		2						90°				C 30W		1	
916.524		2						90°				C 60W		2	
916.519		1						90°				A/C 22W		1	
916.521		1						90°				C 30W		1	
916.526			3					35°				A/C 22W			
916.530			3					35°				C 30W			
916.525			2					35°				A/C 22W			
916.528			2					35°				A/C 22W		1	
916.531			2					35°				C 30W		1	
916.532			2					35°				C 60W		2	
916.527			1					35°				A/C 22W		1	
916.529			1					35°				C 30W		1	
916.510				3				0°				A/C 22W			
916.514				3				0°				C 30W			
916.509				2				0°				A/C 22W		1	
916.512				2				0°				A/C 22W		1	
916.515				2				0°				C 30W		1	
916.516				2				0°				C 60W		2	
916.511				1				0°				A/C 22W		1	
916.513				1				0°				C 30W		1	



916.501



916.508



916.516



916.524



916.532

You will find the matching **device supply cables and Custom Modules** in the 2019 edition of the complete catalogue.

## POWER FRAME

#									
916.534						3	35°	A/C 22W	
916.538						3	35°	C 30W	
916.533						2	35°	A/C 22W	
916.536						2	35°	A/C 22W	1
916.539						2	35°	C 30W	1
916.540						2	35°	C 60W	2
916.535						1	35°	A/C 22W	1
916.537						1	35°	C 30W	1



916.540

# CONI



## CONI

#									
912.169	2						35°	C 60W	2
912.167	1						35°	A/C 22W	1
912.168	1						35°	C 30W	1
912.1676		2					90°	C 60W	2
912.1674		1					90°	A/C 22W	1
912.1675		1					90°	C 30W	1
912.1679			2				35°	C 60W	2
912.1677			1				35°	A/C 22W	1
912.1678			1				35°	C 30W	1
912.1673				2			0°	C 60W	2
912.1671				1			0°	A/C 22W	1
912.1672				1			0°	C 30W	1
912.1683					2		35°	C 60W	2
912.1681					1		35°	A/C 22W	1
912.1682					1		35°	C 30W	1



912.167

You will find the matching **device supply cables and Custom Modules** in the 2019 edition of the complete catalogue.



# USB-A&C Custom Module

The new, space-saving 22 W Custom Module uniquely combines a USB-A and USB-C port. It is ideal for charging common smartphones and tablets as well as many other electrical devices with USB-A or the latest USB-C technology – without cumbersome external mains adapters. Thanks to the integrated USB Power Delivery (PD) and Qualcomm® Quick Charge™, fast charging is no longer a problem.

Quick and flexible in use: the new module is ideal for retrofitting and upgrading existing installations.

## BENEFITS

- **USB-A and USB-C in one**
- **Latest USB-C charging technology**
- **Ideal for retrofitting and upgrades**
- **Fast charging via PD and QC**
- **Integrated current limitation and overheating protection**



**Material:** Plastic

**Colour variants:** 



## USB charger Custom Module

#	
<b>USB-A&amp;C 22 W Custom Module</b>	
917.227	Front side: 1x USB-A socket, 1x USB-C socket   Back side: GST18i3 plug with approx. 0.2 m cable   Black



## Accessories

#	
<b>GST18/earthing contact plug</b>	
Cable: H05VV-F 3G 1.50mm <sup>2</sup>   End 1: Right-angled plug with earthing contact   End 2: Wieland GST18i3 socket	
375.075	2.0m   Black
<b>GST18/Swiss plug</b>	
Cable: H05VV-F 3G 1.00mm <sup>2</sup>   End 1: CH/Swiss plug   End 2: Wieland GST18i3 socket	
375.017	3.0m   Black
<b>GST18/13 A UK plug</b>	
Cable: H05VV-F 3G 1.50mm <sup>2</sup>   End 1: 13 A UK plug   End 2: Wieland GST18i3 socket	
375.068	2.0m   Black
<b>Multiplier, GST18i</b>	
For power forwarding   Input: 3-pole plug section   Output: 3-pole socket section	
375.107	1x input, 2x output (1)   Black
375.102	1x input, 2x output (2)   Black
<b>USB 3.1 Gen2 Type C cable</b>	
918.190	0.5m   Black



### Flexible in integration

Can be used easily and without difficulty in all BACHMANN desk connection panels with Custom Module mount.

You will find matching **desk connection panels** in the 2019 edition of the complete catalogue.



# USB 3.1 Type C keystone

Switch to the new generation of USB connections today! USB 3.1 Type C is the latest standard in the world of devices. And with good reason: amongst other things, the new technology provides a simpler connection thanks to its smaller, anti-twist plug connector. It also supports the 'Power Delivery' functionality, which enables end devices such as tablets and smaller laptops to be charged.

BACHMANN's USB 3.1 Type C keystone module is the perfect interface for this. This flexible module can be quickly and easily inserted into all BACHMANN desk connection panels with modular keystone mounts and used straight away – subsequent changes are also possible. This also means that BACHMANN products already installed can be equipped for the future, too.

## BENEFITS

- **Anti-twist plug connector**
- **Fully assigned contacts enable data and power transfer**
- **Supports Power Delivery charging function up to 36 W**
- **Can be integrated at any time thanks to keystone module**



**Dimensions:** Cable approx. 0.5 m



**Material:** Plastic

**Colour variants:** 

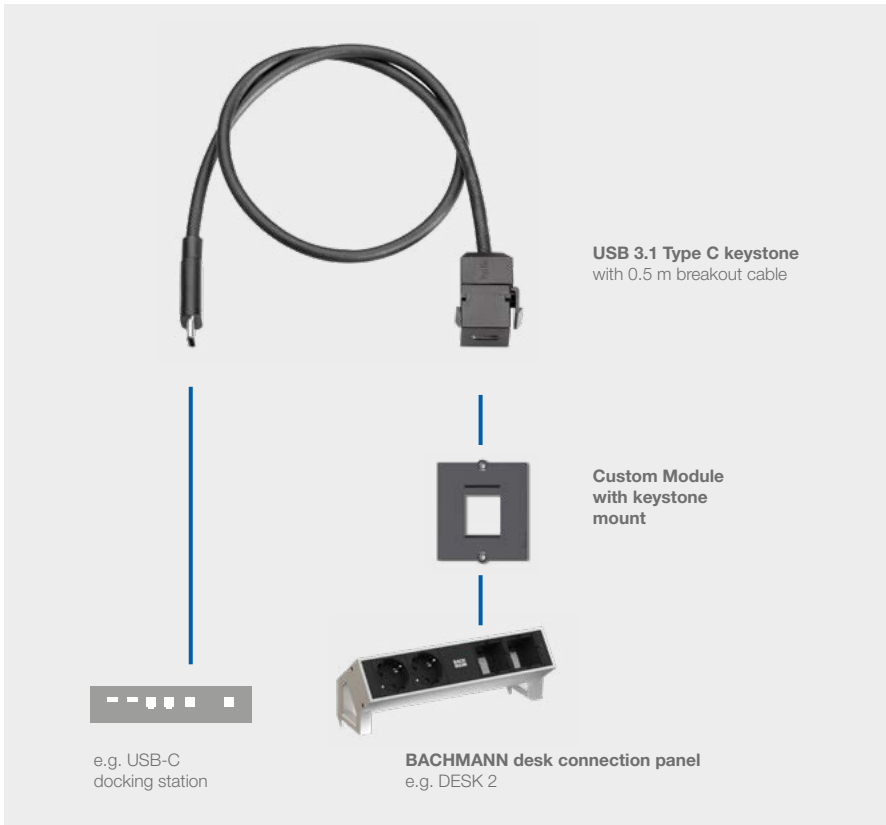
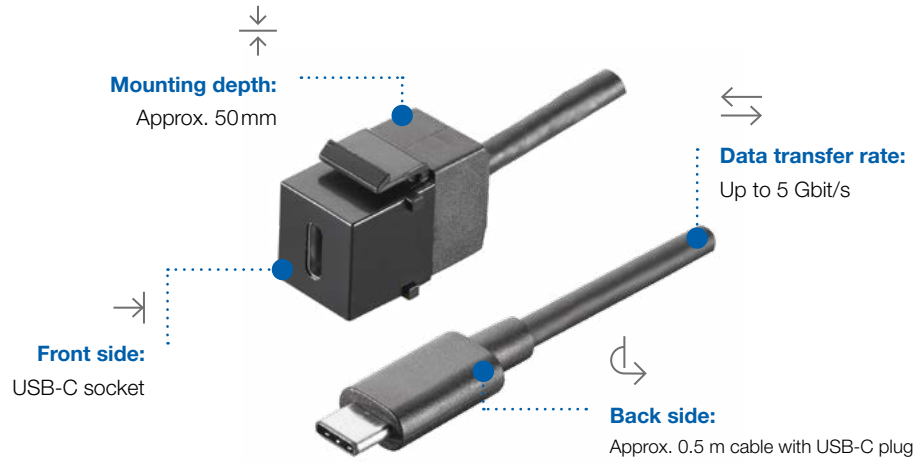

### Simple connection

The keystone can be quickly and easily inserted into all BACHMANN desk connection panels with a modular keystone mount, then used straight away.

## USB 3.1 Type C keystone

· Black

#	
917.121	USB 3.1 Type C   Front side: USB-C socket   Back side: Approx. 0.5m cable with USB-C plug



**i** In order to safeguard the functionality, the maximum total length of the connection should not exceed one metre (keystone with 0.5 m breakout cable plus 0.5 m connection cable).



# INTUBLU

Do you love music and good design? Do you attach importance to a well-designed room concept and would prefer not to spoil the look with a loudspeaker that doesn't fit in? INTUBLU makes loudspeakers that spoil your room's look and get in the way a thing of the past – because from now on, furniture and surfaces will play back your hit list.

INTUBLU consists of two structure-borne sound converters and a Bluetooth mains adapter. Mount everything in the place of your choice – concealed inside cabinets, kitchen drawers or behind your bathroom mirror, pair with your mobile phone or other devices via Bluetooth to immediately enjoy your music in top sound quality. The surface vibration achieved by INTUBLU lets you make the most of existing furniture and forget about the design and loudspeaker cables getting in the way.

## BENEFITS

- **Technology and design united to the highest standard**
- **The best sound quality**
- **Space-saving design**
- **No cables or loudspeakers visible**
- **Easy mounting**



**Dimensions:** Diameter of structure-borne sound converter approx. 68 mm  
**Screw-on points:** Three screw-on points on the loudspeaker

**Material:** Aluminium

**Colour variants:**



Stream your music in the best sound quality  
**without loudspeakers or cables getting in the way.**

**INTUBLU**

· Can be mounted on wood, aluminium, glass, mirrors and plastic

#	
944.000	<p><b>1x Bluetooth mains adapter:</b> Supply cable: 1.5 m H03VVH2-F 2 x 0.75 mm<sup>2</sup> with European plug   110–230 V~ 50/60 Hz   2 screw-on points   Audio outputs: 2x10 W (mono/stereo)</p> <p><b>2x structure-borne sound converters:</b> Supply cable: One 2.0 m PVC connection cable with device-system plug for each   3 screw-on points   Voltage rating: 30 V   Adhesive surface on the back side   Can be mounted using screws or adhesive</p>



944.000



**Mount INTUBLU in the place of your choice**

Concealed inside cabinets, kitchen drawers or behind your bathroom mirror.





# iotspot

The office of tomorrow – available today for employees and facility managers. Do you know the actual extent of workplace utilisation in your building? Or perhaps you already have a desk-sharing model, but one where workplaces are difficult to find? – This is a real nightmare for employees. And for employers? That's quite simple: expensive office space standing empty.

With iotspot integrated into a BACHMANN design connection panel, such as the DESK 2, it is quick and easy to search for, find and reserve workstations. Not only that: facility managers will receive detailed data and analyses on workplace utilisation and therefore also valuable knowledge with a view to cost optimisation.

## BENEFITS

- **2 in 1 – combined connection panel and smart workplace management**
- **Informative facility dashboards**
- **No need for IT network integration**
- **Quick and easy set-up**
- **Intuitive app**



**Dimensions:** (W x H x D): See table x 85 x 100 mm  
**Tabletop thickness:** 10 – 40 mm

**Material:** Profile: Aluminium | Socket: Plastic

## Turn the office into your employees' favourite place.



### DESK 2 power strips with an integrated iotspot module – black

- Dimensions (WxHxD): See *table* x 88 x 85 mm
- Material: Profile: Aluminium | Socket: Plastic
- Tabletop thickness: 10 – 40 mm
- Socket colour: Black



**Without device supply cable** | Power input: 0.2m with GST18 | Including mounting bracket

902.800	2					35°	●		314 mm
902.801	2					35°	●	1	356 mm
902.830		2				45°	●		356 mm
902.831		2				45°	●	1	399 mm
902.810			2			35°	●		314 mm
902.811			2			35°	●	1	356 mm
902.820				2		90°	●		336 mm
902.821				2		90°	●	1	379 mm
902.840					2	35°	●		314 mm
902.841					2	35°	●	1	356 mm



Upon request, the iotspot module can also be incorporated into the DESK, DESK RAIL, CONFERENCE, TOP FRAME, CONI and POWER FRAME.

You will find more information in our **Next Generation Office** brochure or at [www.bachmann.com](http://www.bachmann.com).

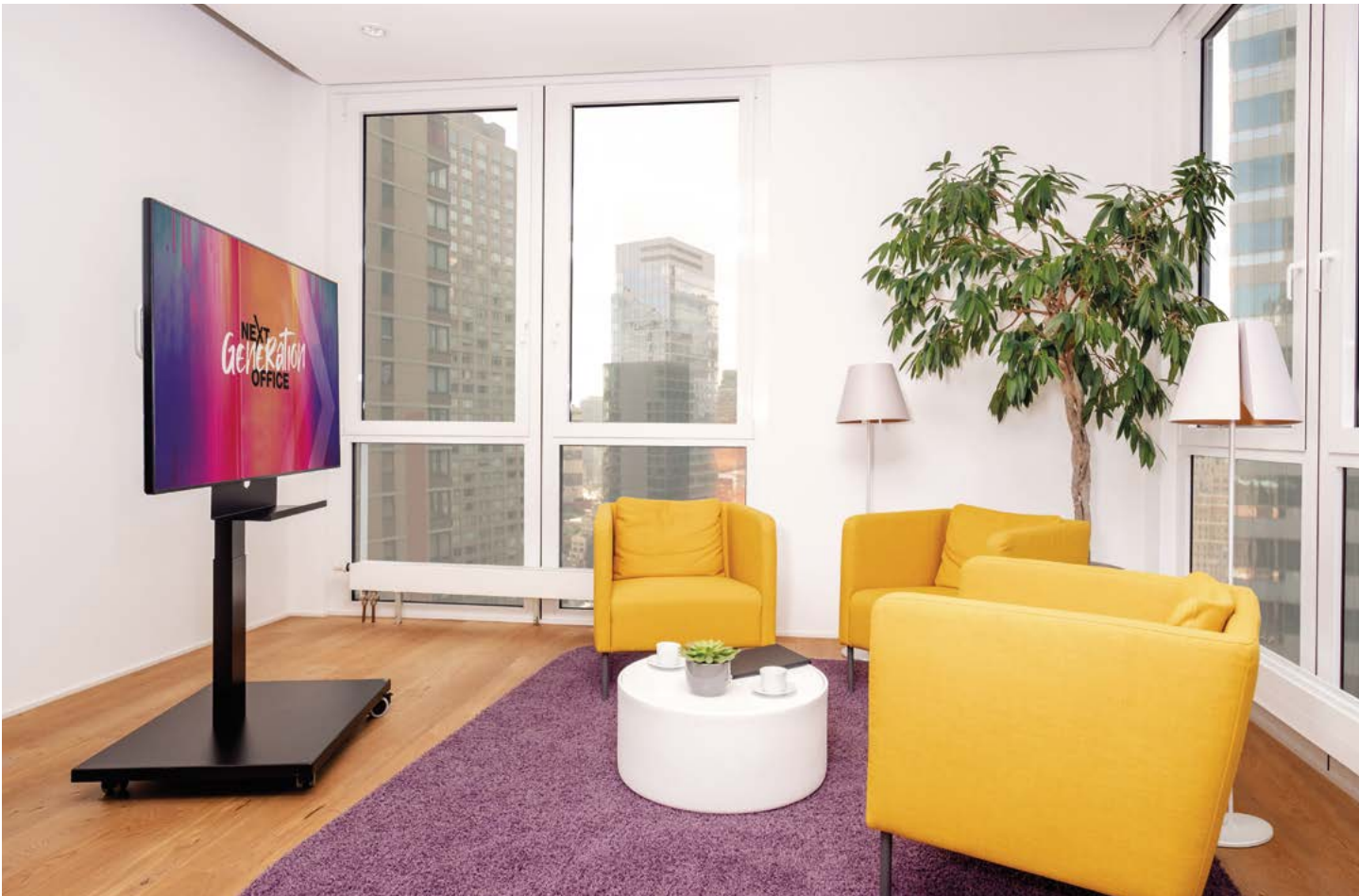

# Independent Monitor

Whether in presentations, video conferences or on websites: the act of sharing visual content with colleagues, customers and partners is key to the world of work today.

The Independent Monitor from BACHMANN offers a new, flexible approach to teamwork: the battery pack means the monitor can be used wherever it is needed, irrespective of rigid infrastructure such as sockets, network connections or cabled devices. It is easy to operate and, thanks to a battery life of 6 to 8 hours, can be used to present information wirelessly for an entire working day.

The integrated status display on the battery pack provides a constant overview of the remaining operating time for the Independent Monitor. Batteries can be fully charged at night to enable reliable, efficient use during the day. A high-resolution display and integrated loudspeakers present audio and video content in high quality.

## BENEFITS

- **Plug & Play**
- **Position anywhere**
- **Long battery life**
- **Can be upgraded with various technical components**
- **Electric height adjustment**



**VESA hole distance:** max. 400 x 400mm  
**Display size:** 58"  
**Max. display weight:** 38kg

Colour variants:





You will find more information in our **Next Generation Office** brochure or at [www.bachmann.com](http://www.bachmann.com).

# Configuration options

Do you want to configure the Independent Monitor to suit your requirements and use it in various situations? BACHMANN offers many options to fulfil your wishes.

## Overview of configuration options

Application components	Basic Bundle 701.0011	Digital Signage Bundle 701.0013	Meeting Bundle 701.0015	Furniture Bundle 701.0017
<b>Battery pack</b>				
700.0010 LI1000 battery pack	•	•	•	•
700.0110 TL150 portable charger	•	•	•	•
<b>Media trolley</b>				
700.3002 Media trolley   Black, similar to RAL9005	•	•	•	
<b>Display</b>				
700.4000 SWEDX SDS58K8-01 monitor	•	•	•	•
<b>Media equipment</b>				
903.700 Barco Clickshare CS-100			•	
903.800 Bright Sign LS423		•		
<b>Accessories</b>				
700.9000 Storage compartment   Black, similar to RAL9005			•	
903.810 Bright Sign Wi-Fi antenna		•		
149.0000 Connection cable for SWEDX SDS58K8-01 monitor   0.6m	•	•	•	
149.0004 Connection cable for SWEDX SDS58K8-01 monitor   2.0m				•
149.0001 Connection cable for Barco Clickshare CS-100			•	•
918.200 HDMI 2.0 cable   1.0m		•	•	
918.201 HDMI 2.0 cable   3.0m				•
700.2010 Docking station   Black, similar to RAL9005				•

**Battery pack**  
700.0010



**Charger**  
700.0110



**Docking station**  
700.2010



**Storage compartment**  
700.9000



**Barco Clickshare**  
903.700



**Bright Sign**  
903.800



You will find more information in our **Next Generation Office** brochure or at [www.bachmann.com](http://www.bachmann.com).

The basic equipment required for flexible use of the Independent Monitor includes the battery pack, media trolley and display.

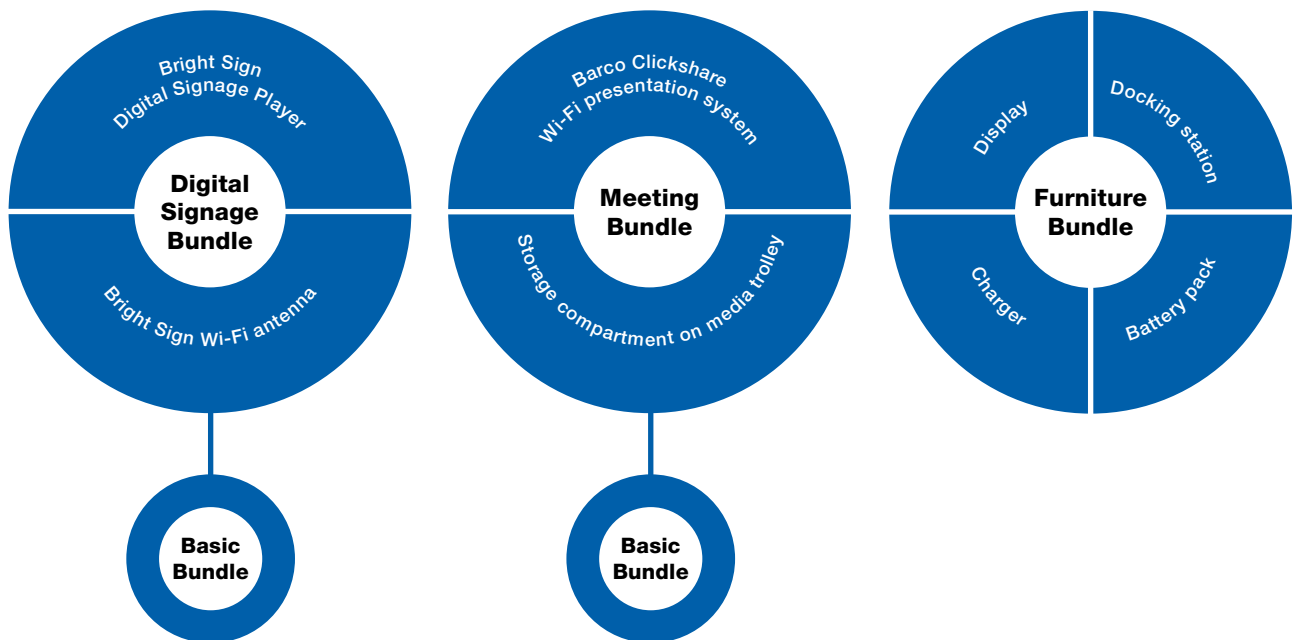
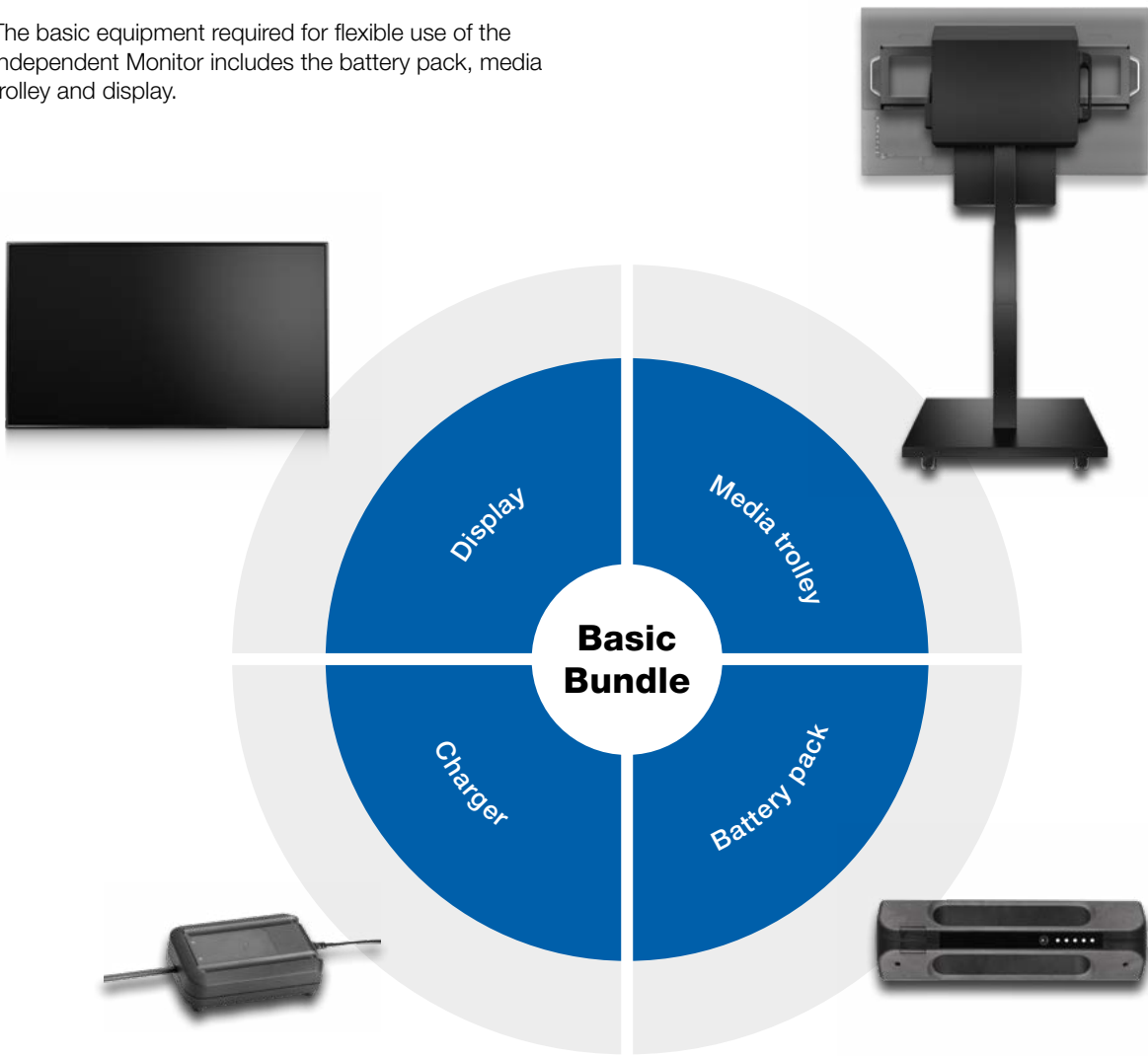



# Independent Workplace

Project-based, flexible working whether in a team or alone – with the Independent Workplace from BACHMANN, cutting-edge features are no longer just a vision of the future. Various scenarios can already be incorporated into the daily routine today. From mobile touchdown areas right through to fully fledged workplaces: the Independent Workplace's modular system enables maximum flexibility.

Autonomous of the power supply system and traditional building infrastructure, the wireless workplace can be flexibly and portably positioned wherever it is needed. The Independent Workplace is supplied as an expandable system kit. This consists of coordinated components that provide the desired mobility and spontaneity, while an innovative battery-pack system enables the workplace to run for an entire working day.

A power-distribution unit in the form of a multi-converter serves as the interface between various end devices and the power supply. Unregulated battery voltage is converted appropriately and supplies compatible hardware with the required operating voltage.

## BENEFITS

- **Mobile, thanks to wireless set-up**
- **Supports contemporary working philosophies**
- **Flexible in the event of workplace reorganisation**
- **Maximises flexibility and spontaneity**
- **Flexibility to respond to changing work situations**



### Desk connection panels:

Suitable desk connection panels upon request

**Attachment:** Option of mounting components on various materials

Colour variants:

## Independent Workplace

#	
<b>Battery pack</b>	
700.0010	LI1000 battery pack   Portable battery pack, capacity 967 Wh, battery voltage 42–58 VDC   Black, similar to RAL9005
700.0110	TL150 portable charger   For mobile charging of the LI1000 battery pack   Black, similar to RAL9005
700.0111	TL150 Fix charger   For stationary charging of the LI1000 battery pack   Black, similar to RAL9005
<b>Power distribution</b>	
700.2010	Docking station   Mount for LI1000 battery pack   Connection for multi-converter or TL150 Fix charger   Black, similar to RAL9005
700.1010	Multi-converter   1x WIELAND GST15i2 (12 VDC/max. 1.5A), 1x WIELAND GST15i2 (24 VDC/max. 4.5A), 3x USB-A chargers, 3x USB-C chargers, PD 2.0   Black, similar to RAL9005
<b>Display</b>	
700.4010	Hannspree HP275CJB   Professional 27" LED display   16:9 picture format   1920x1080 full-HD resolution   USB Type C, powered
<b>Accessories</b>	
903.900	Startech dual-monitor USB-C multi-port adapter   USB-C to dual 4K HDMI adapter   100W, PD 3.0   2x HDMI, 2x USB-A, 1x RJ-45   DP Alt Mode switch
945.001	ZG1 Monitor Arm   Black, similar to RAL9004
945.002	ZG1 Monitor Arm   White, similar to RAL9003
945.003	ZG1 Monitor Arm   Glossy chrome
700.0112	Support for TL150 Fix charger   Mount for the TL150 Fix charger
<b>Connection cable</b>	
918.190	USB 3.1 Type C connection cable   Connection cable for multi-port adapter   0.5m   Black
918.202	USB 2.0 Type C connection cable   Connection cable for Hannspree display   2.0m   Black
918.200	HDMI 2.0 cable   1.0m   Black
918.201	HDMI 2.0 cable   3.0m   Black
149.0005	Connection cable for Linak CBD6S   2.0m   Black
149.0006	Connection cable for LogicData SMARTNEO   2.0m   Black



700.0010



700.0110



700.1010



700.2010



700.4010



700.0112



945.003



# ZG1 MONITOR ARM

The ZG1 Monitor Arm not only features impressive ergonomics and convenient positioning. Its design is also a real highlight. In keeping with the Clean Desk principle, cables are simply hidden by cover plates that can be removed easily. Magnetic covers complete the appealing, contemporary design.

Functionally, its stability is impressive: based on spring-force technology, the arm can even support large monitors (3–11 kg, <34") with ease. The 360° rotation with the smart 180° lock feature ensures individual and secure positioning. The ZG1 Monitor Arm is easy to mount using the handy mounting-tool set behind the removable covers.

To avoid collisions under the desk, the mounting brackets are affixed to the tabletop edge from above.

## BENEFITS

- **Can be mounted from above**
- **High load capacity of up to 11 kg**
- **Clean Desk thanks to concealed cables**
- **Flexible positioning**

## AWARDS



**Dimensions:** 600 x 510 mm  
**Mounting:** Easy mounting from above with mounting bracket.

**Material:** Aluminium

**Colour variants:**



Complete flexibility in **mobility**

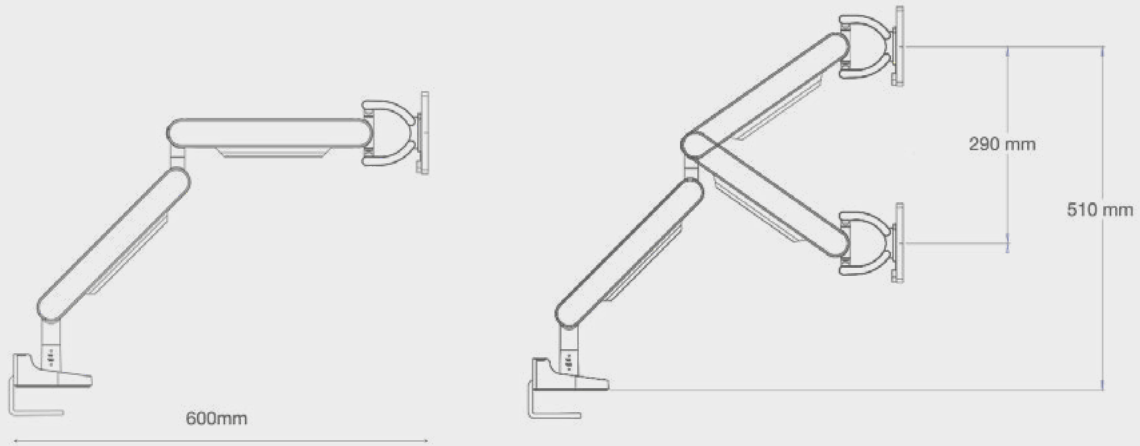

Glossy chrome



Black



White

## ZG1 Monitor Arm

#	
<b>ZG1 Monitor Arm</b>   Dimensions (W x H): 600 x 510 mm   Monitor size 17–34"   Load capacity up to 11 kg   Monitor not included in scope of delivery	
945.001	Monitor Arm; black, similar to RAL9004
945.002	Monitor Arm; white, similar to RAL9003
945.003	Monitor Arm, glossy chrome



945.003





**Smart in approach:**

Concealed under the magnetic covers, the right mounting tool is always to hand.



**Easy mounting:**

No need to crawl under the desk – with mounting brackets, the base can be affixed effortlessly from above.





**Surprisingly strong:**

The strength of the ZG1 Monitor Arm enables it to carry monitors with a weight of up to 11 kg and a size of up to 34".



180° Lock



**Overshoot protection:**

The 180° lock function protects monitors against collisions with the wall behind.



# PEGGY

The neat PEGGY socket strip from BACHMANN promises a new dimension in flexibility and freedom for workbenches, garages and hobby rooms. You can rely on PEGGY wherever you need electricity without having to depend on the availability of sockets.

Thanks to its clamping fixture, the reliable multiple socket can be mounted without any tools on a tabletop edge, worktop, mounting aid, workbench, ladder or door leaf – just where you need it. Do you swap workbenches? Simply take PEGGY with you and clamp it in place in your new working environment.

The cable length of 3 metres guarantees you freedom of movement to do the job in hand. Its shutter, heavy-duty design and stable clamping-fixture grip make PEGGY a true all-rounder and a handy DIY helper.

## BENEFITS

- **Suitable for the home, hobby rooms and garages**
- **Countless custom applications possible**
- **Increased safety thanks to the shutter**
- **Heavy-duty housing and stable grip**
- **3-metre cable**



**Dimensions (W x H x D):** 165 x 133 x 80 mm

**Material:** Plastic

**Clamping range:** Up to 55 mm

**Colour variants:**

**Tabletop thickness:** 14–25 mm

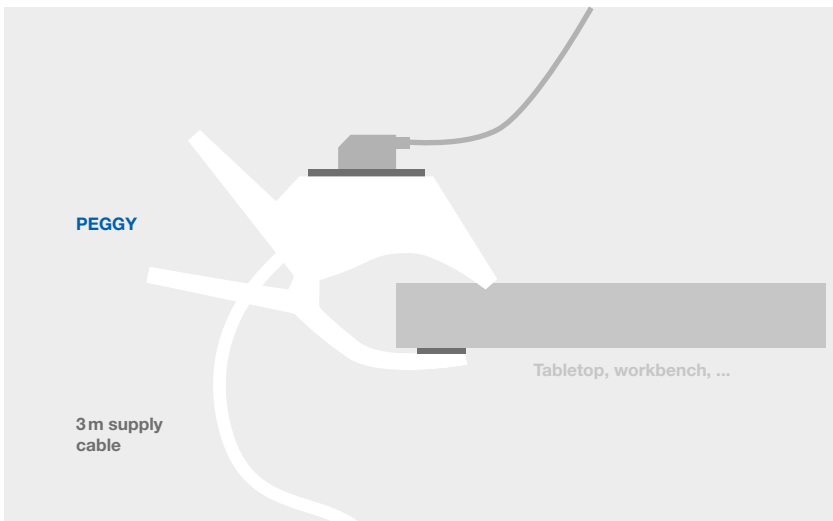

**Flexible power source whenever and wherever you want**

Easy to attach anywhere without tools thanks to the stable clamping fixture.

**PEGGY**

- 3.0 m H05VV-F 3G 1.5 mm<sup>2</sup> supply cable with right-angled plug with earthing contact
- 16A/250V~ | IP20
- With enhanced touch protection
- Colour of the sockets: Dark grey, similar to RAL7010

#		
500.000	3	35°



500.000

# Multiple plugs

## Multiple plugs

#	
921.272	White   Max. 2.5 A/250 V~   3x European socket
921.273	White   Max. 2.5 A/250 V~   4x European socket
921.274	White   Max. 2.5 A/250 V~   2x European socket, 1x CEE7/3 (max. 16 A/250 V~)



# Professional work lamps

## Professional tripod with screw mounting

- For one spotlight
- Extended length: 200 cm
- Retracted length 108 cm
- Distance between the supporting feet: 92 cm
- Diameter of supporting foot: 3.5 cm
- Bearing capacity: 15 kg
- Product weight: 2.2 kg

## Professional tripod with click-head system

- For clamping one spotlight, plus two mounting fixtures for two additional spotlights
- Quick mounting without tools
- Extended length: 200 cm
- Retracted length 108 cm
- Distance between the supporting feet: 92 cm
- Diameter of supporting foot: 3.5 cm
- Bearing capacity: 15 kg
- Product weight: 2.3 kg



#	
730.009	Black   With screw mounting
730.010	Black   With click-head system

# Switches/buttons

## Series 8077 line intermediate switch

- 2 A/250 V~ | On/Off switch, 1-pole
- L x W x H: 61 x 23 x 21 mm
- With screwed contacts
- Screwed housing and strain relief sleeve
- Connecting terminal for the neutral conductor
- For 2-core flat cable, H03VVH2-F 2 x 0.75 mm<sup>2</sup>
- For 2-core round cable, H03VVH2-F 2 x 0.75 mm<sup>2</sup>

#	
924.0390	Housing gold   Rocker gold



924.0390

## Series 3030 pushbutton switch

- 2(1) A, 250 V~ | On/Off switch, 1-pole | T85°C
- Thread length: 7.5 mm
- Bell-shaped nut screwed on

#	
924.1430	Housing black   Rocker black



924.1430

## Series 3634 rocker switch

- 10(4) A, 250 V~ | On/Off switch, 1-pole | T125°C
- Snap-in fixing for cut-out dimensions 19.4 x 13 mm | Mounting depth 18.8 mm
- Suitable for switching the secondary circuit of halogen lamps
- Not illuminated, marking 0-I

#	
924.1270	4.8 mm spade terminals   Housing black   Rocker black



924.1270

# Accessories

## Porcelain terminal

#	
950.009	2-pole with mounting hole in the centre   Hole diameter 4 mm   Dimensions 24 x 22 x 21 mm



950.009

# BACHMANN International

Intercompany | Partner | Country Managers

 **ALBANIA**  
Bachmann GmbH  
Zlatko Zivkovic – Regional Manager  
**Telephone** +381 69 57 75 017  
**Email** zlatko.zivkovic@bachmann.com  
**Web** www.bachmann.com

 **AUSTRIA**  
Bachmann GmbH  
Heiko Bremser – Head Office Germany  
**Telephone** +49 711 86602-120  
**Fax** +49 711 86602-34  
**Email** heiko.bremser@bachmann.com  
**Web** www.bachmann.com

Burisch Elektro Systemtechnik GmbH  
Percostraße 16  
1220 Vienna  
**Telephone** +43 1250 010  
**Fax** +43 125 001 250  
**Email** office@burisch.co.at  
**Web** www.burisch.co.at

 **BELGIUM**  
Bachmann GmbH  
Esther Torrealday Bollar – Head Office Germany  
**Telephone** +49 711 86602-148  
**Fax** +49 711 86602-34  
**Email** esther.bollar@bachmann.com  
**Web** www.bachmann.com

Vander Elst NV – SA  
Oostvaardtdijk 42  
1850 Grimbergen  
**Telephone** +32 2 242 79 59  
**Fax** +32 2 242 26 24  
**Email** info@vanderelst-electric.eu  
**Web** www.vanderelst-electric.eu

 **BOSNIA-HERZEGOVINA**  
Bachmann GmbH  
Zlatko Zivkovic – Regional Manager  
**Telephone** +381 69 57 75 017  
**Email** zlatko.zivkovic@bachmann.com  
**Web** www.bachmann.com

 **BULGARIA**  
Bachmann GmbH  
Zlatko Zivkovic – Regional Manager  
**Telephone** +381 69 57 75 017  
**Email** zlatko.zivkovic@bachmann.com  
**Web** www.bachmann.com

 **CHINA**  
Bachmann Electronics Co., Ltd  
No. 3, 1st Road of North Gate  
Industrial Zone Hengken  
Administrative District Liaobu Town  
Dongguan City, Guangdong Province, China  
**Telephone** + 86 0769 38810001  
**Email** apac@bachmann.com  
**Fax** + 86 0769 38810002  
**Web** www.bachmann.com

 **CROATIA**  
Bachmann GmbH  
Zlatko Zivkovic – Regional Manager  
**Telephone** +381 69 57 75 017  
**Email** zlatko.zivkovic@bachmann.com  
**Web** www.bachmann.com

 **CYPRUS**  
Bachmann GmbH  
Zlatko Zivkovic – Regional Manager  
**Telephone** +381 69 57 75 017  
**Email** zlatko.zivkovic@bachmann.com  
**Web** www.bachmann.com

 **CZECH REPUBLIC**  
Bachmann GmbH  
Sendi Murk – Sales Engine International  
**Telephone** +420 725 708 468  
**Email** sendi.murk@bachmann.com  
**Web** www.bachmann.com

 **DENMARK**  
Bachmann GmbH  
Heidi Grove – Country Manager  
**Telephone** +49 711 86602-0  
**Fax** +49 711 86602-34  
**Email** heidi.grove@bachmann.com  
**Web** www.bachmann.com

 **ESTONIA**  
Bachmann GmbH  
Margo Kõrgesaar – Country Manager  
**Telephone** +372 51 78 489  
**Email** margo.korgesaar@bachmann.com  
**Web** www.bachmann.com

 **FINLAND**  
Bachmann GmbH  
Anne Suuronen – Country Manager  
**Mobile** +35 840 15 10 905  
**Email** anne.suuronen@bachmann.com  
**Web** www.bachmann.com

 **FRANCE**  
Bachmann S.A.R.L.  
Régis Lécuyer – Country Manager  
**Telephone** +33 6 26 88 67 25  
**Email** contact@bachmann.com

**Showroom address:**  
Micro Parc – Bâtiment E  
33, Rue des Chardonnerets  
93290 Tremblay-en-France  
**Postal address:**  
BP0364 Tremblay-en-France  
95942 ROISSY CDG CEDEX  
**Telephone** +33 1 48 63 17 00  
**Fax** +33 1 48 63 17 08  
**Email** contact@bachmann.com  
**Web** www.bachmann.com

 **GERMANY**  
Bachmann GmbH  
Ernstthaldenstraße 33  
70565 Stuttgart  
**Telephone** +49 711 86602-0  
**Fax** +49 711 86602-34  
**Email** info@bachmann.com  
**Web** www.bachmann.com

 **GREECE**  
Bachmann GmbH  
Zlatko Zivkovic – Regional Manager  
**Telephone** +381 69 57 75 017  
**Email** zlatko.zivkovic@bachmann.com  
**Web** www.bachmann.com

 **HONG KONG**  
Bachmann Hong Kong Ltd  
8/F, No. 88 Hing Fat Street  
Causeway Bay, Hong Kong SAR of China  
**Telephone** +852 28 022 638  
**Fax** +852 28 342 938  
**Email** salesap@bachmann.com  
**Web** www.bachmann.com

 **HUNGARY**  
Bachmann GmbH  
Heiko Bremser – Head Office Germany  
**Telephone** +49 711 86602-120  
**Fax** +49 711 86602-34  
**Email** heiko.bremser@bachmann.com  
**Web** www.bachmann.com

Burisch Villanyszerelési Rendszerek  
Kereskedelmi kft.  
Schweidel u. 2  
1047 Budapest  
**Telephone** +36 1 399 8020  
**Fax** +36 1 369 5731  
**Email** burischkft@burisch.hu  
**Web** www.burisch.net

 **ICELAND**  
Bachmann GmbH  
**Telephone** +49 711 86602-0  
**Fax** +49 711 86602-34  
**Email** info@bachmann.com  
**Web** www.bachmann.com

 **IRELAND**  
Bachmann GmbH  
Sajitha Velautham – Head Office Germany  
**Telephone** +49 711 86602-722  
**Fax** +49 711 86602-34  
**Email** sajitha.velautham@bachmann.com  
**Web** www.bachmann.com

LMC Electrical Systems  
Les McCormack  
Oak House, Unit 1 Oak Park Industrial Estate  
Oak Rd, Western Industrial Estate  
Dublin 12  
**Telephone** +353 14 242 414  
**Fax** +353 14 242 411  
**Email** sales@lmces.com  
**Web** www.lmces.com/en

 **ITALY**  
Bachmann GmbH  
**Web** www.bachmann.com

Häfele Italia S.R.L.  
Distribution HOME & OFFICE Solutions  
Via della Valle, 69  
20841 Carate Brianza  
**Telephone** +39 0362 57 741  
**Fax** +39 0362 57 74 477  
**Email** info@hafele.it  
**Web** www.hafele.com

COMM-TEC S.R.L.  
Distribution Audio/Video  
Via Proventa 90  
48018 Faenza  
**Telephone** +39 0546 622 080  
**Fax** +39 0546 622 090  
**Email** commerciale@comm-tec.it  
**Web** www.comm-tec.it

 **LATVIA**  
Bachmann GmbH  
Margo Kõrgesaar – Country Manager  
**Telephone** +372 51 78 489  
**Email** margo.korgesaar@bachmann.com  
**Web** www.bachmann.com

 **LITHUANIA**  
Bachmann GmbH  
Margo Kõrgesaar – Country Manager  
**Telephone** +372 51 78 489  
**Email** margo.korgesaar@bachmann.com  
**Web** www.bachmann.com



**LUXEMBOURG**  
 Bachmann GmbH  
 Esther Torrealday Bollar – Head Office Germany  
**Telephone** +49 711 86602-148  
**Fax** +49 711 86602-34  
**Email** esther.bollar@bachmann.com  
**Web** www.bachmann.com

Marco Zenner S.À.R.L.  
 Zone Industrielle Zare Est  
 4385 Ehlerange  
**Telephone** +352 44 15 441  
**Fax** +352 45 57 73  
**Email** contact@zenner.lu  
**Web** www.zenner.lu

**NORTHERN MACEDONIA**  
 Bachmann GmbH  
 Zlatko Zivkovic – Regional Manager  
**Telephone** +381 69 57 75 017  
**Email** zlatko.zivkovic@bachmann.com  
**Web** www.bachmann.com

**MALTA**  
 Bachmann GmbH  
 Zlatko Zivkovic – Regional Manager  
**Telephone** +381 69 57 75 017  
**Email** zlatko.zivkovic@bachmann.com  
**Web** www.bachmann.com

**MONTENEGRO**  
 Bachmann GmbH  
 Zlatko Zivkovic – Regional Manager  
**Telephone** +381 69 57 75 017  
**Email** zlatko.zivkovic@bachmann.com  
**Web** www.bachmann.com

**NETHERLANDS**  
 Bachmann GmbH  
**Web** www.bachmann.com

Office Cabling Systems BV  
 Distributiestraat 19  
 4283 JN Giessen  
 Nederland  
**Telephone** +31 183 309 425  
**Fax** +31 183 309 424  
**Email** info@ocsystems.nl  
**Web** www.ocsystems.nl

**NORWAY**  
 Bachmann GmbH  
 Violetta Braun – Head Office Germany  
**Telephone** +49 711 86602-873  
**Fax** +49 711 86602-34  
**Email** violetta.braun@bachmann.com  
**Web** www.bachmann.com

Ergoline AS  
 Distribution OFFICE Solutions  
 Oksenøyveien 80  
 1366 Lysaker  
**Telephone** +47 67 58 79 79  
**Email** post@ergo-line.com  
**Web** www.ergo-line.com

**POLAND**  
 Bachmann GmbH  
 Rafal Nowakowski – Country Manager South Poland  
**Telephone** +48 508 121 066  
**Email** rafal.nowakowski@bachmann.com  
**Web** www.bachmann.com

Robert Zabazny – Country Manager North Poland  
**Telephone** +48 660 626 799  
**Email** robert.zabazny@bachmann.com  
**Web** www.bachmann.com

P.P.U.H EL-Team SP. Z O.O.  
 Al.Mlodych 26-28  
 41-106 Siemianowice Sl  
**Telephone** +48 32 204 36 28  
**Fax** +48 32 220 00 05  
**Email** el-team@el-team.com.pl  
**Web** www.el-team.com.pl

**PORTUGAL**  
 Bachmann S.A.  
 Susana Ruiz – Administrative Office  
**Telephone** +34 93 50 41 253  
**Email** susana.ruiz@bachmann.com

Edificio Trade Center  
 Avda.Corts Catalanes 5-7, 1ª Planta  
 08173 Sant Cugat del Valles – Barcelona  
**Telephone** +34 93 50 41 253  
**Fax** +34 93 50 41 273  
**Email** info@bachmann.com  
**Web** www.bachmann.com

DNL – Duarte Neves, L.DA  
 Distribution to electrical wholesalers  
 Qta dos Estrangeiros  
 Rua D, 78  
 2665-601 Venda do Pinheiro  
**Telephone** +351 219 668 100  
**Email** info@duarteneves.pt  
**Web** www.duarteneves.pt

**ROMANIA**  
 Bachmann Romania S.R.L.  
**Telephone** +40 269 806 730  
**Email** razvan.dumitrache@bachmann.com

Str. Stadionului 88  
 551105 Medias  
**Telephone** +40 269 806 730  
**Fax** +40 269 846 730  
**Email** info@bachmann.ro  
**Web** www.bachmann.com

**RUSSIA**  
 Bachmann GmbH  
 Margo Korgesaar – Country Manager  
**Telephone** +372 51 78 489  
**Email** margo.korgesaar@bachmann.com  
**Web** www.bachmann.com

Norkpalm  
 Pavel Poslanchik  
 Ryabinovaya 61A  
 121471 Moscow  
**Telephone** +7 495 92 13 999  
**Email** p.poslanchik@norkpalm.ru  
**Web** www.norkpalm.ru

**SERBIA**  
 Bachmann GmbH  
 Zlatko Zivkovic – Regional Manager  
**Telephone** +381 69 57 75 017  
**Email** zlatko.zivkovic@bachmann.com  
**Web** www.bachmann.com

**SLOVAKIA**  
 Bachmann GmbH  
 Sendi Murk – Sales Engine International  
**Telephone** +420 725 703 468  
**Email** sendi.murk@bachmann.com  
**Web** www.bachmann.com

**SLOVENIA**  
 Bachmann GmbH  
 Zlatko Zivkovic – Regional Manager  
**Telephone** +381 69 57 75 017  
**Email** zlatko.zivkovic@bachmann.com  
**Web** www.bachmann.com

**SPAIN**  
 Bachmann S.A.  
 Susana Ruiz – Administrative Office  
**Telephone** +34 93 50 41 253  
**Email** susana.ruiz@bachmann.com

Edificio Trade Center  
 Avda.Corts Catalanes 5-7, 1ª Planta  
 08173 Sant Cugat del Valles – Barcelona  
**Telephone** +34 93 50 41 253  
**Fax** +34 93 50 41 273  
**Email** info@bachmann.com  
**Web** www.bachmann.com

**SWEDEN**  
 Bachmann GmbH  
 Violetta Braun – Head Office Germany  
**Telephone** +49 711 86602-873  
**Fax** +49 711 86602-34  
**Email** violetta.braun@bachmann.com  
**Web** www.bachmann.com

Andersson System  
 P. Andersson AB  
 Västra Rydsvägen 134  
 196 31 Kungsängen  
**Telephone** +46 8 581 753 00  
**Mobile** +46 70 438 20 65  
**Fax** +46 8 581 753 01  
**Email** info@p-andersson.se  
**Web** www.p-andersson.se

**SWITZERLAND**  
 Bachmann GmbH  
 Heiko Bremser – Head Office Germany  
**Telephone** +49 711 86602-120  
**Fax** +49 711 86602-34  
**Email** heiko.bremser@bachmann.com  
**Web** www.bachmann.com

Max Hauri AG  
 Weidstrasse 16  
 9220 Bischofszell  
**Telephone** +41 71 42 42 525  
**Fax** +41 71 42 42 590  
**Email** verkauf@maxhauri.ch  
**Web** www.maxhauri.ch

Riedo Networks Ltd – IT Infrastructure  
 Route de la Fonderie 6  
 1700 Fribourg  
**Telephone** +41 26 50 55 000  
**Email** info@riedonetworks.com  
**Web** www.riedonetworks.com

**TURKEY**  
 Bachmann GmbH  
 Zlatko Zivkovic – Regional Manager  
**Telephone** +381 69 57 75 017  
**Email** zlatko.zivkovic@bachmann.com  
**Web** www.bachmann.com

**UK**  
 Bachmann Electrical Engineering Ltd  
 James Peckitt – Country Manager  
**Mobile** +44 794 098 5335  
**Email** james.peckitt@bachmann.com

77 Farringdon Road  
 EC1M 3JU London  
 United Kingdom  
**Telephone** +44 135 469 225  
**Fax** +44 135 469 1614  
**Email** sales@bachmann.com  
**Web** www.bachmann.com

**UKRAINE**  
 Bachmann GmbH  
 Alexandru Tutuianu – Sales Office

**Telephone** +40 269 806730  
**Email** alexandru.tutuianu@bachmann.ro  
**Web** www.bachmann.com

V.E.S. Group LTD  
 Kharkovskoye shosse 201-203  
 02121 Kiev  
**Telephone** +380 44 36 40 004  
**Email** bachmann@vesgroup.com.ua  
**Web** vesgroup.com.ua

**UNITED ARAB EMIRATES**  
 Bachmann GmbH  
 Johanna Tauber-Jerkovic – Head Office Germany  
**Telephone** +49 711 86602-62  
**Fax** +49 711 86602-34  
**Email** johanna.jerkovic@bachmann.com  
**Web** www.bachmann.com









## Pictograms and their meanings

#	Item number		Surge protection
	Version		Mains and frequency filter
€	Price in EUR		Colour
	Socket outlet with earthing contact		Residual-current device
	UK socket (3.15 A)		Automatic switch-off
	UTE socket		Rewirable
	Swiss socket (10A)	19"	Compatible with 19" racks
	European socket		Custom Module
	Italian/Socket outlet with earthing contact, P40		Keystone
	Italian socket (10A)		USB charger
	Socket orientation		Width
	Switch		Dimensions

## Further information



### Custom Module

Module that is screwed into an empty slot on a power strip.



### Keystone

Module that is inserted into a Custom Module using a keystone mount.



In principle, all of our power strips **have enhanced touch protection (a shutter)**.



For reasons related to the production process, there may be deviations from the specified dimensions and illustrations. We thank you for your understanding in this matter.

