



safe.inspiring.green.



Junction boxes 12-71

Abox m / Abox-i m, Abox / Abox-i, Abox SL / Abox-i SL, Abox XT, Abox HA..... 14-51
 Red Range 52-61
 HP, WK 62-70
 Accessories 70-71
 Technical data for terminals 48-51



Intrinsic fire resistance 72-117

WKE 2 - 5 DUO, WKE 1 - 5 74-85
 WKE 200 - 400 RK, WKE 405 LSA 86-93
 WKE 2 - 5 SB, WKE 200 - 400 SB 94-99
 WKE 54 100-101
 WKE AK 14-70 102-107
 WKE *Rapid-Box* 108-117



Terminal block housings 118-139

RK *Compact*, RK, RKA 120-135
 AKi-R 132-135
 ALR *Compact*, ALR-L 136-138
 Accessories 139



Distribution boards 140-167

AK / AK Plus 142-149
 AK-F / AK-F Plus (Flange type) 147-151
 Accessories AK Air 152-153
 AKe 154-157
 AK *Compact*, AKi *Compact* 158-161
 Accessories AKe / AK *Compact*, AKi *Compact* 162-167



Empty socket distribution boxes 168-173

STV-L 169
 Accessories STV-L 170-173



Empty enclosures 174-241

TK-PS, TK-PC, Accessories TK 176-202
 TK-AL 195-197
 TG-ABS, TG-PC, Accessories TG 204-223
 AKL/AKi-L, Accessories AKL/AKi-L 224-233
 AL, Accessories AL 234-237
 SVi automatic machine enclosure 238-241

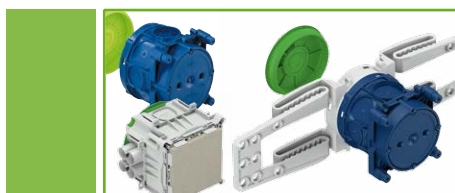

Concrete Installation 242-279

IBT Junction boxes for concrete construction 244-256
 IBT reinforcement box 248-249
 IBT Junction boxes for lightweight concrete, IBT Export versions 257-260
 IBT Accessories 260-267
 IBT LED Universal mounting enclosure 272-274
 IBTronic-System, IBTronic XL, IBTronic XL Drillbox 268-279



Cavity wall installation system, Trunking boxes 280-291

HW Cavity wall sockets and boxes 282-284
 Accessories HW 284-286
 KD Trunking boxes 288-290
 Accessories KD 290-291

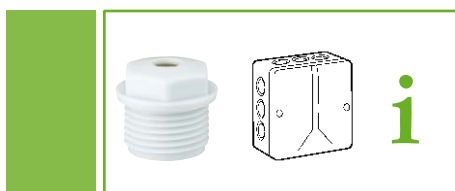

Accessories, further information 292-358

Universal accessories 292-297
 Technical appendix 298-345
 Index of order numbers 346-357
 General Terms and Conditions 358



When you turn to Spelsberg, you are choosing a partner who is always a step ahead thanks to several decades of experience with state-of-the-art technology. High-quality, refined products and a strong focus on customers assures maximum assurance for everyone involved.

This applies for the functionality of the components - all process steps from consultation and offer preparation to delivery and service, which guarantees that our customers will feel secure with us. In the process, we keep everyone in mind: the assembler who installs our products quickly

and easily and our partners in retail, for whom ordering and stocking of products are made easy with modular designs and accompanying accessories.

The enthusiasm and knowledge of our employees are the essential key to our success. Consequently, unique, high-quality products and tailored solution are only possible with the commitment and passion of our staff. Our customers value us as a series supplier with a comprehensive catalogue and finely tuned systems. We are also an expert consultant for demanding questions involving the housing.

We develop, test and produce tailor-made, comprehensive solutions - but we also make small adjustments according to customer wishes.

Our founder, Ernst Spelsberg would certainly be proud that his values still guide our company after four generations and our staff has the same pioneering spirit of the early years of the company.



Till Fastabend
Managing Director

Holger Spelsberg
Managing Director



Spelsberg is represented by partners and subsidiaries in more than 50 countries.



Our subsidiaries:

Spelsberg-els-UK Ltd.
Great Britain

Spelsberg S.L.
Spain

Spelsberg spol. s r.o.
Czech Republic

Spelsberg B.V.
Netherlands

Spelsberg A/S
Denmark

Spelsberg AB
Sweden



International contacts

Peter Niclas

Export Manager
T +49 2355 892 143
F +49 2355 892 50 143
M +49 170 8119816
Email: pni@spelsberg.de

Frank Massallek

Export Manager
T +49 2355 892 245
F +49 2355 892 50 245
M +49 151 52492605
Email: fma@spelsberg.de

Christoph Balzer

Export Manager
T +49 2355 892 275
F +49 2355 89250 275
M +49 175 5939123
Email: cba@spelsberg.de

**Central Europe
Eastern Europe
Near / Middle
and Far East**

**Western Europe
North America
Southern Europe**

Northern Europe

We are there for you nationally and internationally



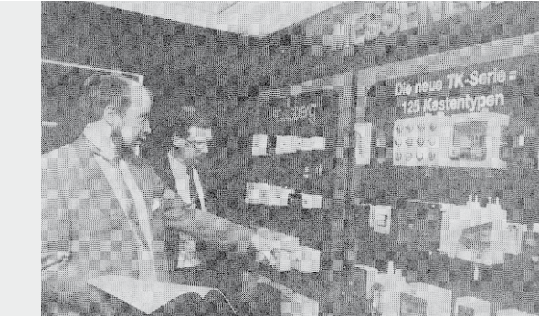
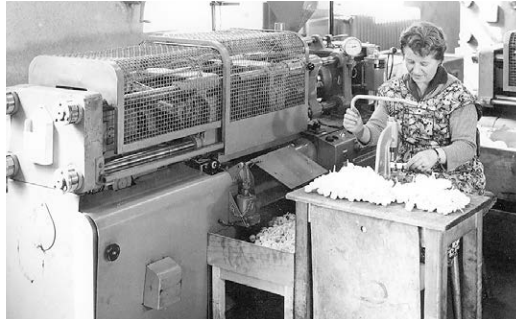

What began with the **vision** of the founding father, Ernst Spelsberg - of making electrical installation **easier** and **safer** - is still being rigorously pursued today in the fourth generation of the family business. **Practical** brand-name products for the branching, protection and distribution of electrical power have long been part of our daily business. But we have never lost sight of our **pioneering**

spirit and make every effort to develop safer, user-specific products. **Spelsberg makes life easier for customers.**



Founding father Ernst Spelsberg

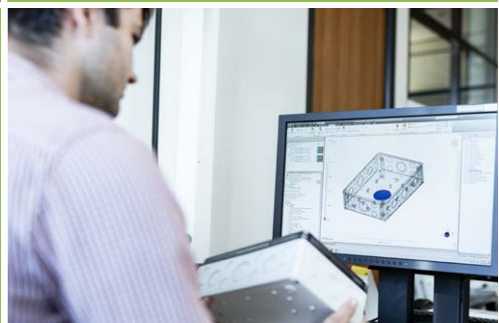
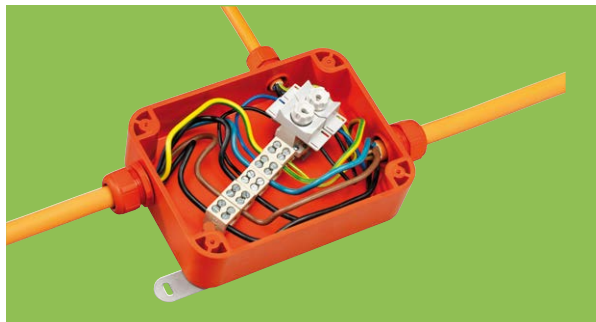
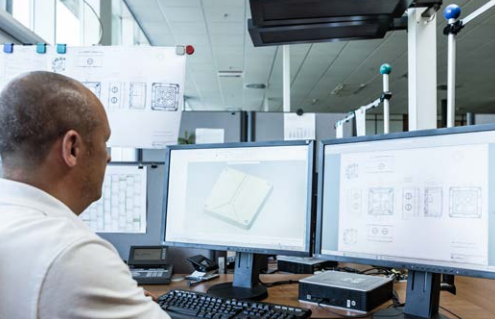

Regardless of whether **non-standard small enclosure**, customised **enclosure** or **complete modules** – we are a committed **development partner** as regards the implementation of **customer wishes**. By focusing on the **project business**, we create **tailor-made, individual solutions** for industry every day. Located **fully**, at the site in Schalksmühle, a consistent **process chain** – from project

management through development, construction, prototyping, tool design, tool making and production – enables fast, **high-quality implementation** of projects. Testing and certifications in accordance with **VDE** and **UL** are carried out in our **in-house testing laboratory**.



More than 700 active tools weighing up to 8.9 tons. Use of more than 2,500 tons of material per year.



IK level impact testing



Housing production



Tool production

Customers who purchase products from Spelsberg receive brand-name quality that is **developed, manufactured and tested in Germany**. In addition to our headquarters in Schalksmühle, we have a production facility in Buttstädt, Thüringen. Spelsberg is also represented by a dense network of company-owned subsidiaries and sales offices worldwide.

Schalksmühle – where it all began!

Spelsberg is still headquartered in the city where the first insulating tubes were developed and manufactured in 1904. The company grew continuously and increasingly expanded its production facilities until it outgrew the city centre. As a result, the company relocated to an industrial area in the 1990s, where the

new administrative and production centre were built. All technical departments work together closely and are interlinked there. This is the driving force behind the **innovative power** and short reaction times. Therefore, it is only natural to always remain a step ahead within the sector.



Small distribution board production



Silos



Abox automation junction boxes

Buttstädt – the plastics centre

The more than 100 million plastic parts produced by Spelsberg each year do not originate from Schalksmühle alone. The company has also had a production location in Buttstädt, Thüringen, where the high-quality housings are manufactured.

Whether a two-component injection mould, seal foam or a custom mix of materials, Buttstädt also provides the expected variety and quality with state-of-the-art machinery and a large supply of tools.



100 %
Made in Germany



All processes
under one roof



UL impact testing



Air conditioning cabinets tested to -30 degrees

When you are looking for tested **safety** and brand-name quality, Spelsberg is the answer. We only use high-quality **brand-name** European raw materials for the more than 100 million injection-moulded parts that we produced each year.

We use a total of 400 raw material types – 95 per cent of which are produced according to our own recipe. Our products with especially high durability bear the **iQ** mark **for industrial quality**.

Tested safety | Always in focus



Dust cabinet



Cover tensile testing

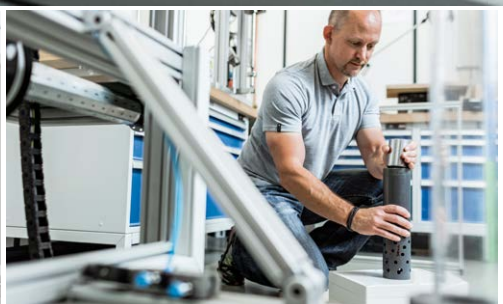

IK impact testing



Water protection testing

Spelsberg operates an **in-house test laboratory** at its headquarters in Schalksmühle for certification purposes. The laboratory and devices are not just **VDE-certified**, they are also **UL-certified**, thus enabling all of the necessary inspections for the international use of series products and special solutions to be conducted in-house.

This possibility is especially important when developing **tailor-made solutions** together with our partners. The aim here is to help our customers get their products to market readiness as rapidly as possible.

The test laboratory is equipped to **state-of-the-art** standards and is the subject of ongoing further development. UL conducts and annual audit as part of the Client Test Data Program to assure that work continues to be carried out at a consistently high standard.



Class of protection (IP code) acc.to DIN EN 60529 (VDE 0470-1)



Maximum number of **distribution units**



Electrical functional integrity acc.to DIN 4102-12
"E" stands for functional integrity, "30-90" stands for the duration in minutes.



Insulation integrity according to VDE 0472-814, IEC 60331
"FE" stands for the impact of flames or fire,
"180" stands for the time in minutes



Operating duration acc. to DIN EN 12101-3
120 minutes function at 400 °C



Tested acc. to DIN 4102-2. **Functional integrity F90** (according to E90) for protecting the electrical installations as per MLAR 2005.
Can be individually equipped with type-tested operating materials.



Tested acc. to DIN 4102-2. **Fire load insulation F90** (according to E90) for protecting the exit and escape routes as per MLAR 2005.



Fire-resistance class S 90 acc. to DIN 4102-9



Certificate of conformity. Conformity of the construction product with the technical regulations is documented by the "Ü label"



The German general building supervisory approval (AbZ) attests the usability of an object under approval in the sense of the building regulations. It is granted by the German Institute of Structural Engineering (DIBt), Berlin, for construction products and types of construction, where no harmonised European standards have yet been applied for them and which are also not regulated by German standards or regulations.



German general building inspection test certificate (AbP) is granted for unregulated construction products and construction methods whose use is not intended to meet the full safety criteria for structures. The granting is carried out by recognised testing bodies.



Nominal cross section The greatest permissible wire cross-section that can be connected acc. to DIN EN 60998 (VDE 0613) and DIN EN 60999 (VDE 0609)



Level of protection (IK code) to mechanical impact acc. to DIN EN 50102 (VDE 0470-100)



Protection class II operating materials with protective insulation to DIN VDE 0100-410



Maximum **voltage DC** (DC voltage) as per product standard (system voltage in the PV sector)



Nominal AC voltage (AC voltage).
Highest permissible voltage on the junction as per product norm

15A

Rated current (maximum current in continuous operation) as per product norm



Products for **installation in cavity walls or furnishings** acc. to DIN VDE 0606-1.



Products for **use in concrete construction** acc. to DIN VDE 0606-1



Suitable for the installation of lamps in which dichroic reflector lamps (**cool beam reflectors**) can be used. Reduces the thermal load in the light bundle.



Suitable for LED lights



Suitable for use in concrete. **Resistant to momentary temperatures of up to +90 °C** during the hardening process.



960°C glowing wire testing



c UL us (Underwriters Laboratories) **approved** (American and Canadian approval)



UL EU New European test certificate for certification recognised across Europe.



DLG FokusTest for special innovations of machines and technical products - predominantly in agricultural and forestry applications.



AK Air Ventilation elements to prevent accumulation of condensate while maintaining protection class IP65.



The **VDE symbol** stands for the tested safety of the product with regard to electrical, mechanical, thermal and other hazards.



Vattenfall approval



Suitable for the installation of an **electronic domestic supply meter**



Halogen-free enclosure, without halogens such as fluorine, chlorine and bromine.



Industrial quality

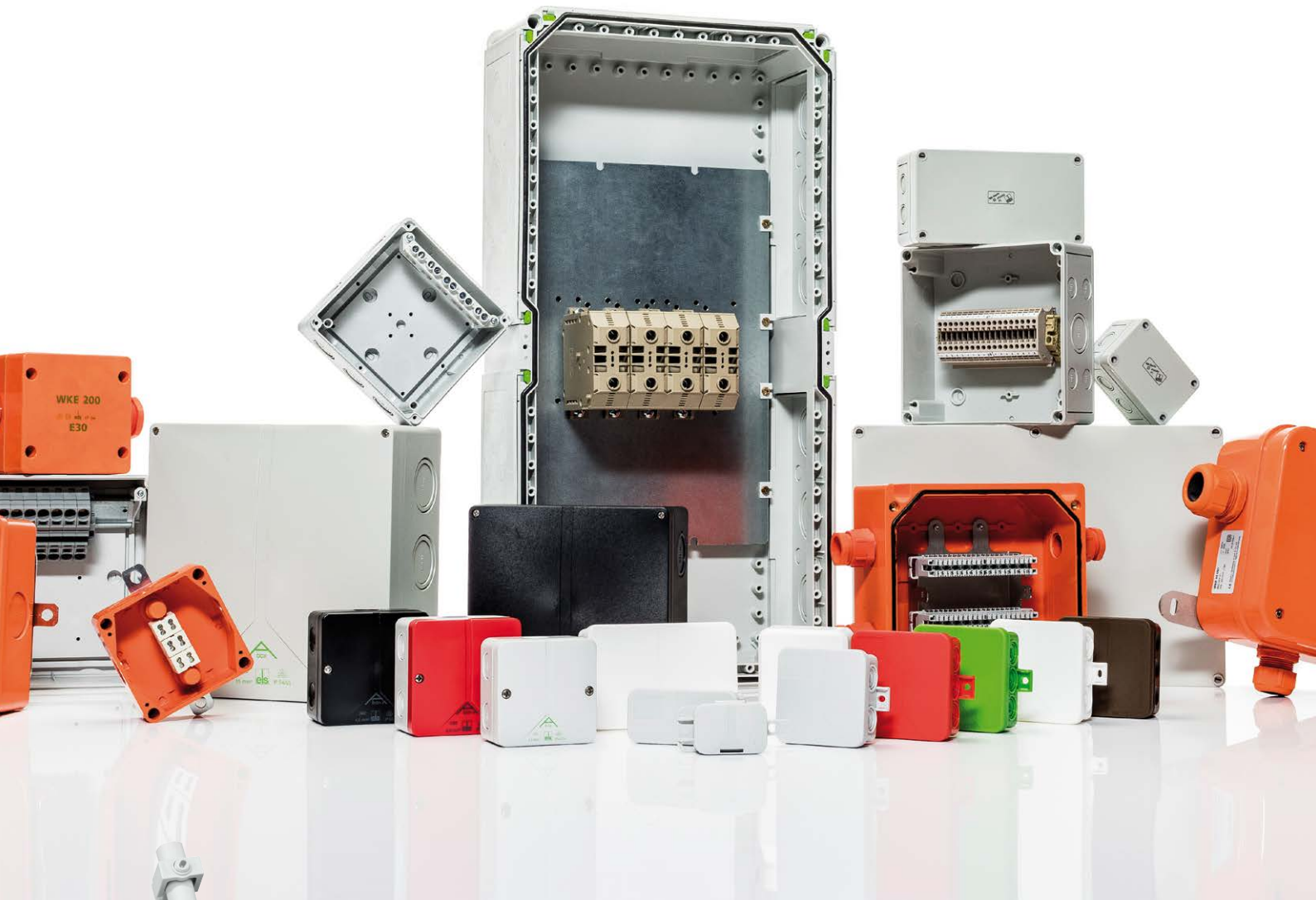

Our junction boxes offer lots of space for installation. For example, our popular Abox series with raised terminals. They allow quick and orderly wiring.

From the classic wet room installation about waterproof versions with IP68 up to junction boxes with functional integrity to E90. We have the right solution for every application.

	Protection rating	Max. rated cross-section	Types	Page
	IP65	2.5 mm ²	Junction boxes for protected installations with metric knock-outs Abox m	14-16
	IP65	70 mm ²	Junction boxes for protected installations Abox 025 to 700	17-22
	IP65	16 mm ²	Junction boxes with screwless terminal technology Abox <u>SL</u>	24-26
	IP66	2.5 mm ²	Junction boxes for protected installations with metric knock-outs Abox-i m 025 to Abox-i m 40	27-29
	IP65	240 mm ²	Junction boxes Abox-i 025 to Abox-i 40	30-37
	IP65	16 mm ²	Junction boxes with screwless terminal technology Abox-i <u>SL</u>	38-40
	IP68	10 mm ²	Junction boxes for use with cast resin Abox-i <u>XT</u>	41-43
	IP65/54	35 mm ²	Junction boxes with stepped nipples Abox HA	44
	IP54	25 mm ²	Junction boxes for wet-room installations Red Range	52-61
	IP55	10 mm ²	Junction boxes with stepped nipples HP 70 to HP 190	62-65
	IP54	25 mm ²	Junction boxes made from duroplastic WK 007 to WK 250	66-70
	Technical information - terminal			48-51
	General accessories for junction boxes			71

Mounting points for attaching the Abox terminal in 2 different positions

Cover fastener with 2 stainless steel cross slot screws. Sealing via Abox PST sealing set in accessories

Front now featuring 3 x M20 inlets for Abox(-i) m 040

Rear side featuring teeth for secure placement on the subsurface



NEW!
With metric knock-outs

- Tothing for easier positioning during installation
- Abox m 040 with 3 x M20 knockouts on one end face
- Abox m 025 and Abox m 040: 2K cover with integrated cover seal and insulating plugs

25 new variations
(2.5 mm² and 4 mm²) with metric knock-outs on the sides and in the base



Abox m 025

82 x 82 x 51 mm

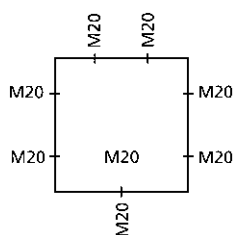

Description

Order no.

Junction box acc. to DIN EN 60670 (VDE 0606), $U_i=690V$, with knock-outs, with IP54 attachment bushes, with blanking plug M20, seal range 8 - 13.5 mm

IP65
IP542,5²

IK07

690V
AC**Abox m 025-L**

Grey, without terminal

807 907 01

Abox m 025-2,5²Grey, with screw terminal, 5-pole - 2.5 mm² (4 x 1.5² / 4 x 2.5²)

807 407 01

Abox m 025 SB-L

red cover, without terminal, for identifying circuits for safety lighting

807 707 01

Abox m 025 AB

82 x 82 x 51 mm

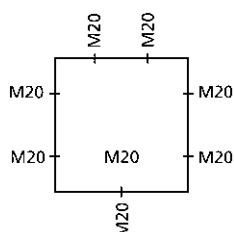

Junction box acc. to DIN EN 60670 (VDE 0606), $U_i=690V$, with knock-outs, with IP54 attachment bushes, with blanking plug M20, seal range 8 - 13.5 mm, with external attachment lugs

IP65
IP542,5²

IK07

690V
AC**Abox m 025 AB-L**

Grey, without terminal

808 907 01

Abox m 025 AB-2,5²Grey, with screw terminal, 5-pole - 2.5 mm² (4 x 1.5² / 4 x 2.5²)

808 407 01

Abox m 025 AB SB-L

red cover, without terminal, for identifying circuits for safety lighting

808 707 01

Abox m 040

94 x 94 x 56 mm

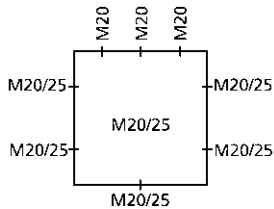

Description

Order no.

Junction box acc. to DIN EN 60670 (VDE 0606), $U_i=690V$, with knock-outs, with IP54 attachment bushes, M20, M20/M25, seal range 8 - 13.5 mm, seal range 9 - 18.5 mm

IP65
IP54

4²

IK07



690V
AC



Abox m 040-L

Grey, without terminal

811 907 01

Abox m 040-4²

Grey, screw terminal, 5-pole - 2.5/4 mm² (4 x 1.5² / 4 x 2.5² / 3 x 4²)

811 407 01

Abox m 040 SB-L

Red cover, without terminals, for identifying circuits for safety lighting

811 707 01

Abox m 040 AB

94 x 94 x 56 mm

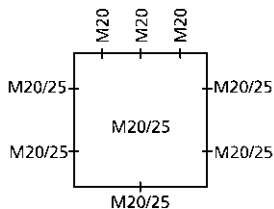

Junction box acc. to DIN EN 60670 (VDE 0606), $U_i=690V$, with knock-outs, with IP54 attachment bushes, M20, M20/M25, seal range 8 - 13.5 mm, seal range 9 - 18.5 mm, with external attachment lugs

IP65
IP54

4²

IK07



690V
AC



Abox m 040 AB-L

Grey, without terminal

812 907 01

Abox m 040 AB-4²

Grey, screw terminal, 5-pole - 2.5/4 mm² (4 x 1.5² / 4 x 2.5² / 3 x 4²)

812 407 01

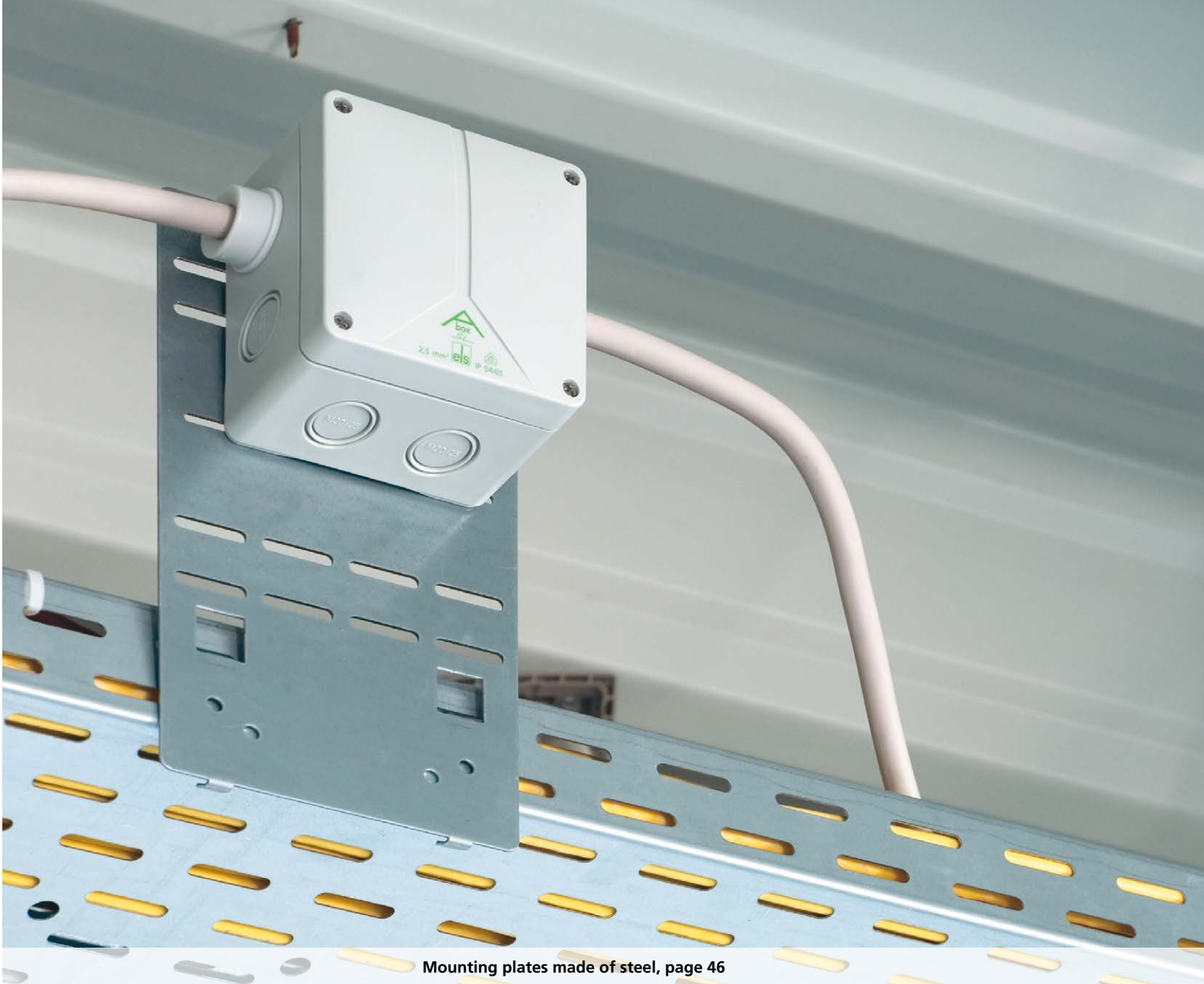

Mounting plates made of steel, page 46



- Ample room for connection
- Simple test method
- Raised terminals for quick and orderly wiring (from Abox-i 060)
- Quick installation with self-sealing membrane entries (on Abox-i 025 and 040)
- With red cover for identifying circuits for safety lighting
- Also suitable for use under extreme conditions



Junction boxes Abox 025 to 700

Abox 025

80 x 80 x 52 mm

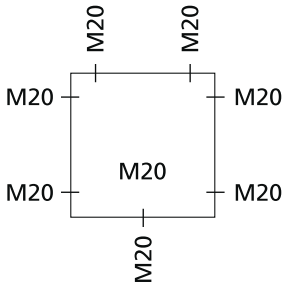

Description

Order no.

Junction box acc. to DIN EN 60670 (VDE 0606), $U_i=690V$, with self-sealing, soft inlet membranes, M20, seal range 2 - 16 mm



Abox 025-L Grey, without terminal	802 907 01
Abox 025-2,5² Grey, with screw terminal, 5-pole - 2.5 mm² (4 x 1.5² / 4 x 2.5²)	802 407 01
Abox 025-L/w white, without terminal	802 607 01
Abox 025-2,5²/w White, with screw terminal, 5-pole - 2.5 mm² (4 x 1.5² / 4 x 2.5²)	802 107 01
Abox 025 SB-L red cover, without terminal, for identifying circuits for safety lighting	802 707 01

Abox 025 AB

80 x 80 x 52 mm

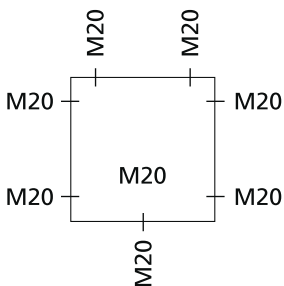

Junction box acc. to DIN EN 60670 (VDE 0606), $U_i=690V$, with self-sealing, soft inlet membranes, M20, seal range 2 - 16 mm, with external fixing lugs



Abox 025 AB-L Grey, without terminal	803 907 01
Abox 025 AB-2,5² Grey, with screw terminal, 5-pole - 2.5 mm² (4 x 1.5² / 4 x 2.5²)	803 407 01
Abox 025 AB-L/w white, without terminal	803 607 01
Abox 025 AB-Pot Grey, with 15 mm standard rail TS 15, PE terminal strip 4²	803 427 01
Abox 025 AB-2,5²/w White, with screw terminal, 5-pole - 2.5 mm² (4 x 1.5² / 4 x 2.5²)	803 107 01

Abox 040

93 x 93 x 55 mm

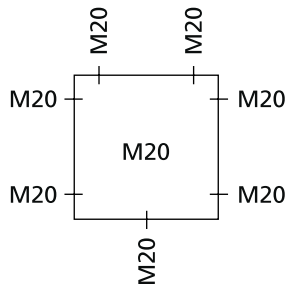

Description

Order no.

Junction box acc. to DIN EN 60670 (VDE 0606), $U_i=690V$, with self-sealing, soft inlet membranes, M20, seal range 2 - 16 mm

IP65

4²

IK07



690V
AC



Abox 040-L

Grey, without terminal

804 907 01

Abox 040-4,0²

Grey, screw terminal, 5-pole - 2.5/4 mm² (4 x 1.5² / 4 x 2.5² / 3 x 4²)

804 407 01

Abox 040-L/w

white, without terminal

804 607 01

Abox 040-4,0²/w

White, with screw terminal, 5-pole - 2.5/4 mm² (4 x 1.5² / 4 x 2.5² / 3 x 4²)

804 107 01

Abox 040 SB-L

Red cover, without terminals, for identifying circuits for safety lighting

804 707 01

Abox 040 AB

93 x 93 x 55 mm

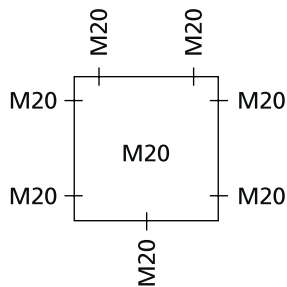
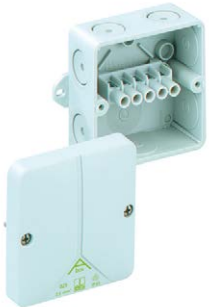

Junction box acc. to DIN EN 60670 (VDE 0606), $U_i=690V$, with self-sealing, soft inlet membranes, M20, seal range 2 - 16 mm, with external fixing lugs

IP65

4²

IK07



690V
AC



Abox 040 AB-L

Grey, without terminal

805 907 01

Abox 040 AB-4²

Grey, screw terminal, 5-pole - 2.5/4 mm² (4 x 1.5² / 4 x 2.5² / 3 x 4²)

805 407 01

Abox 040 AB-L/w

white, without terminal

805 607 01

Abox 060

110 x 110 x 67 mm

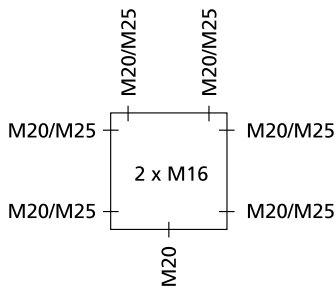

Description

Order no.

Junction box acc. to DIN EN 60670 (VDE 0606), $U_i=690V$, with IP54 attachment bushes, with blanking plug M25, seal range 9 - 18.5 mm

IP65
IP54

6²

IK07



690V
AC



Abox 060-L

Grey, without terminal

806 907 01

Abox 060-6²

Grey, with high-set screw terminal, 5-pole - 6 mm² (4 x 2.5² / 4 x 4² / 3 x 6²)

806 407 01

Abox 060 SB-L

Red cover, without terminals, for identifying circuits for safety lighting

806 707 01

Abox 100

140 x 140 x 79 mm

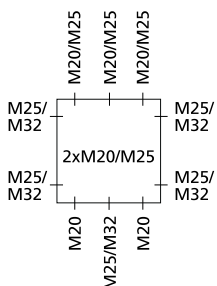

Junction box acc. to DIN EN 60670 (VDE 0606), $U_i=690V$, with IP54 attachment bushes, with blanking plug M32, seal range 13 - 23 mm

IP65
IP54

10²

IK07



690V
AC



Abox 100-L

Grey, without terminal

810 910 01

Abox 100-10²

Grey, with high-set screw terminal, 5-pole - 10 mm² (4 x 4² / 4 x 6² / 4 x 10²)

810 410 01

Abox 160

180 x 180 x 91 mm

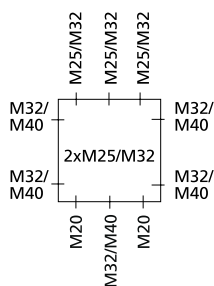

Description

Order no.

Junction box acc. to DIN EN 60670 (VDE 0606), $U_i=690V$, with IP54 attachment bushes, with blanking plug M40, seal range 17 - 30 mm, with sealing kit

IP65 IP54
16²
IK07

690V AC

Abox 160-L 816 910 01
Grey, without terminals

Abox 160-16² 816 410 01
Grey, with high-set screw terminal,
5-pole - 16 mm² (4 x 6² / 4 x 10² / 4 x 16²)

Abox 250

250 x 200 x 115 mm

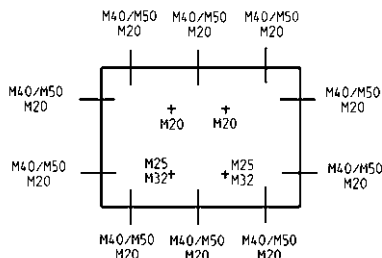

Junction box acc. to DIN EN 60670 (VDE 0606), $U_i=690V$, with IP54 attachment bushes, with blanking plug M40, seal range 17 - 30 mm, with sealing kit

IP65 IP54
25²
IK07

690V AC

Abox 250-L 825 910 01
Grey, without terminals

Abox 250-25² 825 410 01
Grey, with high-set screw terminal,
5-pole - 25 mm² (4 x 10² / 4 x 16² / 4 x 25²)

Abox 350

250 x 250 x 115 mm

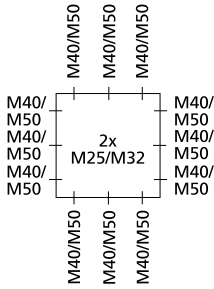

Description

Order no.

Junction box acc. to DIN EN 60670 (VDE 0606), $U_i=690V$, with IP54 attachment bushes, with blanking plug M40, seal range 17 - 30 mm, with sealing kit

IP65
IP54

35²

IK07



690V
AC



Abox 350-L

Grey, without terminals

835 910 01

Abox 350-35²

Grey, with high-set screw terminal,
5-pole - 35 mm² (4 x 10² / 4 x 16² / 4 x 25² / 4 x 35²)

835 410 01

Abox 700

300 x 450 x 132 mm

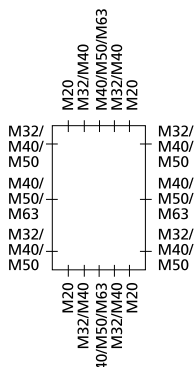

Junction boxes, $U_i=690V$, with 3 twist nipples and lock nut, IP54, M63, seal range 24 - 43 mm, standard version sealable

IP65
IP54

70²

IK07



690V
AC



Abox 700-L

Grey, without terminals

870 910 01

Abox 700-70²

Grey, 4 terminal blocks 4 x 70 mm², 16-70²

870 410 01

Accessories

Abox 700 KLS-70²

1-pole - 70 mm²

840 070 01

NS35-216/3

universal floor fixing

795 030 01

AK MPI 3

AKL/AKi 3-4, Abox 700

795 003 01



M20/23

M20/23

M20/23



- The Abox SL combines the wiring philosophy of the Abox series with screwless terminal technology.
- Standard installation in wet rooms
- Installation on flammable surfaces
- Installation in agricultural and horticultural premises

- Installation in areas with increased requirements for vibration and shock resistance
- Quick installation thanks to screwless terminal technology
- Maintenance-free
- Vibration- and shock-proof

* SL = Screwless terminal technology



Junction boxes Abox SL*

Abox SL-2,5/4²

110 x 110 x 67 mm

NEW!

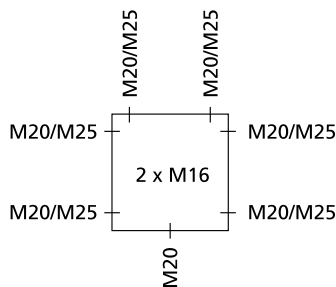

Description

Order no.

Junction box acc. to DIN EN 60670 (VDE 0606), with IP54 attachment bushes, with blanking plug M25, seal range 9 - 18.5 mm

IP65
IP54

4²

IK07



400V
AC



Abox SL-2,5/4²

Grey, with 5-pole high-set screwless terminal, max. cross-section acc. DIN EN 60998:4 mm², for current carrying capacity of 24 A, cross sections that can be clamped per pole: 3 x 0.2 up to 4 mm² rigid and 3 x 0.14 up to 4.0 mm² flexible

806 107 01

Abox SL-2,5-KT

Grey, with high-set terminal carrier, without terminal

806 197 02

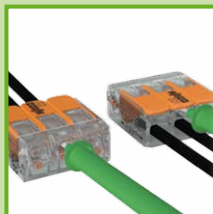

Abox SL-6²

140 x 140 x 79 mm

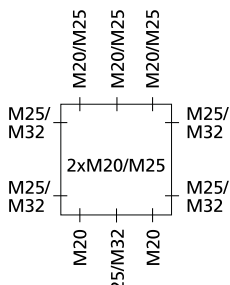

Junction box acc. to DIN EN 60670 (VDE 0606), U_i=690V, with IP54 attachment bushes, with blanking plug M32, seal range 13 - 23 mm

IP65
IP54

6²

IK07



690V
AC



Abox SL-6²

Grey, with 5-pole high-set screwless terminal, max. cross-section acc. EN 60998: 6 mm², for current carrying capacity of 41 A, cross sections that can be clamped per pole: 4 x 0.5 up to 10 mm² rigid and flexible

810 810 01

Abox SL-10²
180 x 180 x 91 mm

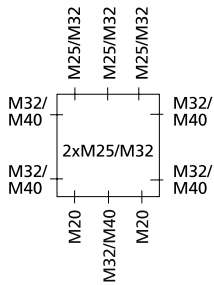

Description

Order no.

Junction box acc. to DIN EN 60670 (VDE 0606), $U_i=690V$, with IP54 attachment bushes, with blanking plug M40, seal range 17 - 30 mm, with sealing kit



Abox SL-10²
Grey, with 5-pole high-set screwless terminal, max. cross-section acc. EN 60998: 10 mm², for current carrying capacity of 57 A, cross sections that can be clamped per pole: 4 x 0.5 up to 16 mm² rigid and flexible

816 810 01

Abox SL-16²
250 x 200 x 115 mm

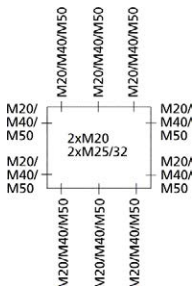

Junction box acc. to DIN EN 60670 (VDE 0606), $U_i=690V$, with IP54 attachment bushes, with blanking plug M40, seal range 17 - 30 mm, with sealing kit



Abox SL-16²
Grey, with 5-pole high-set screwless terminal, max. cross-section acc. EN 60998: 16 mm², for current carrying capacity of 76 A, cross sections that can be clamped per pole: 4 x 0.5 up to 16 mm², rigid, 4 x 0.5 up to 25 mm² flexible

835 810 01

Mounting points for attaching the Abox terminal in 2 different positions

Cover fastener with 2 stainless steel cross slot screws. Sealing via Abox PST sealing set in accessories

Front now featuring 3 x M20 inlets for Abox(-i) m 040

Rear side featuring teeth for secure placement on the subsurface



NEW!
With metric knock-outs



G. SPELSBERG
JUNCTION BOX SERIES ABOX-I
WITH ACCESSORIES
✓ Resistance to Ammonia
DLG Test Report 6398

- Toothing for easier positioning during installation
- Abox-i m 040 with 3 x M20 knockouts on one end face
- Abox-i m 025 and Abox-i m 040: 2K cover with integrated cover seal and insulating plugs

25 new variations
(2.5 mm² and 4 mm²) with metric knock-outs on the sides and in the base



Junction boxes Abox-i m 025 to 40

Abox-i m 025

82 x 82 x 51 mm

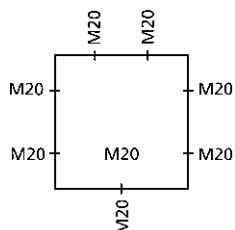

Description

Order no.

Junction box - **Industrial Quality** - acc. to DIN EN 60670 (VDE 0606), $U_i=690V$, weatherproof, shock-proof, with knock-outs, M20, For IP66 double membrane seals, for suitable cable in-feeds see accessories



Abox-i m 025-L Grey, without terminal	496 902 01
Abox-i m 025-2,5² Grey, with screw terminal, 5-pole - 2.5 mm ² (4 x 1.5 ² / 4 x 2.5 ²)	496 402 01
Abox-i m 025-L/sw black, without terminal	498 902 01
Abox-i m 025-2,5²/sw Black, with screw terminal, 5-pole - 2.5 mm ² (4 x 1.5 ² / 4 x 2.5 ²)	498 402 01

Abox-i m 025 AB

82 x 82 x 51 mm

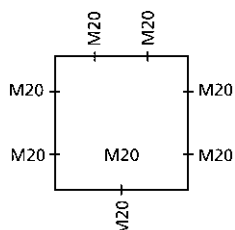

Junction box - **Industrial Quality** - acc. to DIN EN 60670 (VDE 0606), $U_i=690V$, weatherproof, shock-proof, with knock-outs, M20, For IP66 double membrane seals, with external attachment lugs, for suitable cable in-feeds see accessories



Abox-i m 025 AB-L Grey, without terminal	499 902 01
Abox-i m 025 AB-2,5² Grey, with screw terminal, 5-pole - 2.5 mm ² (4 x 1.5 ² / 4 x 2.5 ²)	499 402 01
Abox-i m 025 AB-L/sw black, without terminal	499 903 01

Abox-i m 040

94 x 94 x 56 mm

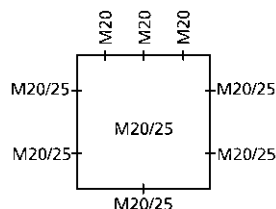

Description

Order no.

Junction box - **Industrial Quality** - acc. to DIN EN 60670 (VDE 0606), $U_i=690V$, weatherproof, shock-proof, with knock-outs, M20, M20/M25, for IP66 double membrane seals, for suitable cable in-feeds see accessories

IP66

4²

IK08

690V
AC**Abox-i m 040-L**

Grey, without terminal

501 904 01

Abox-i m 040-4²Grey, with screw terminal, 5-pole - 2.5/4 mm² (4 x 1.5² / 4 x 2.5² / 3 x 4²)

501 404 01

Abox-i m 040-L/sw

black, without terminal

502 904 01

Abox-i m 040-4²/swBlack, with screw terminal, 5-pole - 2.5/4 mm² (4 x 1.5² / 4 x 2.5² / 3 x 4²)

502 404 01

Abox-i m 040 AB

94 x 94 x 56 mm

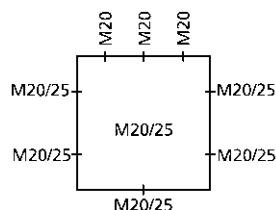

Junction box - **Industrial Quality** - acc. to DIN EN 60670 (VDE 0606), $U_i=690V$, weatherproof, shock-proof, with knock-outs, M20, M20/M25, for IP66 double membrane seals, with external attachment lugs, for suitable cable in-feeds see accessories

IP66

4²

IK08

690V
AC**Abox-i m 040 AB-L**

Grey, without terminal

503 904 01

Abox-i m 040 AB-4²Grey, screw terminal, 5-pole - 2.5/4 mm² (4 x 1.5² / 4 x 2.5² / 3 x 4²)

503 404 01

Abox-i m 040 AB-L/sw

black, without terminal

503 905 01



**G. SPELSBERG
JUNCTION BOX SERIES ABOX-I
WITH ACCESSORIES**

✓ **Resistance to Ammonia**
DLG Test Report 6398

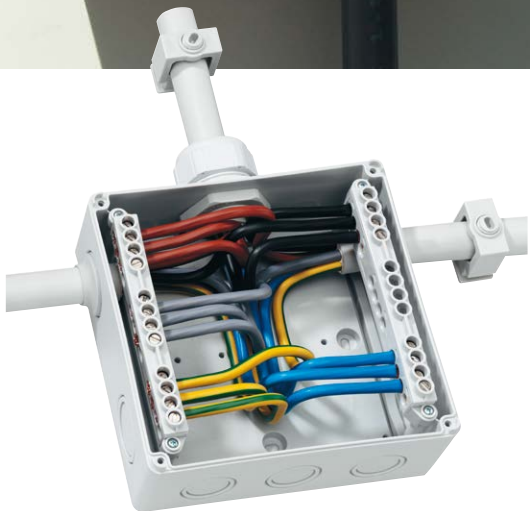

- Shockproof
- Ample room for connection
- Simple test method
- Raised terminals for quick and orderly wiring (from Abox-i 060)
- Quick installation with self-sealing membrane entries (on Abox-i 025 and 040)
- Impact-resistant and shatterproof (e.g. in sports halls)
- With red cover for identifying circuits for safety lighting
- Also suitable for use under extreme conditions



Junction boxes Abox-i 025 to 2400

www.spelsberg.com

Abox-i 025

80 x 80 x 52 mm

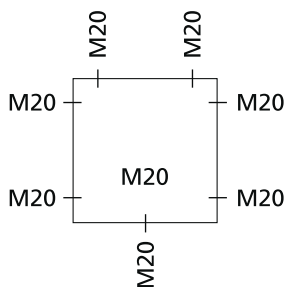

Description

Order no.

Junction box - **Industrial Quality** - acc. to DIN EN 60670 (VDE 0606), $U_i=690V$, weatherproof, shock-proof, halogen-free, with self-sealing, soft inlet membranes, M20, seal range 2 - 16 mm

IP65

2,5²

IK08

690V
AC**Abox-i 025-L**

Grey, without terminal

490 902 01

Abox-i 025-2,5²Grey, with screw terminal, 5-pole - 2.5 mm² (4 x 1.5² / 4 x 2.5²)

490 402 01

Abox-i 025 SB-L

red cover, without terminal, for identifying circuits for safety lighting

490 702 01

Abox-i 025-L/sw

black, without terminal

491 902 01

Abox-i 025-2,5²/swBlack, with screw terminal, 5-pole - 2.5 mm² (4 x 1.5² / 4 x 2.5²)

491 402 01

Abox-i 025 AB

80 x 80 x 52 mm

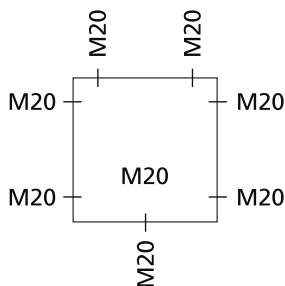

Junction box - **Industrial Quality** - acc. to DIN EN 60670 (VDE 0606), $U_i=690V$, weatherproof, with self-sealing, soft inlet membranes, M20, seal range 2 - 16 mm, with external fixing lugs

IP65

2,5²

IK08

690V
AC**Abox-i 025 AB-L**

Grey, without terminal

494 902 01

Abox-i 025 AB-2,5²Grey, with screw terminal, 5-pole - 2.5 mm² (4 x 1.5² / 4 x 2.5²)

494 402 01

Abox-i 025 SB AB-L

red cover, without terminal, for identifying circuits for safety lighting

494 702 01

Abox-i 025 AB-L/sw

black, without terminal

491 903 01

Abox-i 040

93 x 93 x 55 mm

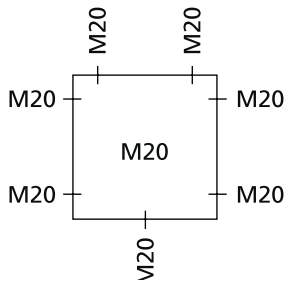

Description

Order no.

Junction box - Industrial Quality - acc. to DIN EN 60670 (VDE 0606), $U_i=690V$, weatherproof, shock-proof, halogen-free, with self-sealing, soft inlet membranes, M20, seal range 2 - 16 mm



Abox-i 040-L Grey, without terminal	490 904 01
Abox-i 040-4² Grey, with screw terminal, 5-pole - 2.5/4 mm² (4 x 1.5² / 4 x 2.5² / 3 x 4²)	490 404 01
Abox-i 040 SB-L Red cover, without terminals, for identifying circuits for safety lighting	490 704 01
Abox-i 040-L/sw black, without terminal	491 904 01
Abox-i 040-4²/sw Black, with screw terminal, 5-pole - 2.5/4 mm² (4 x 1.5² / 4 x 2.5² / 3 x 4²)	491 404 01

Abox-i 040 AB

93 x 93 x 55 mm

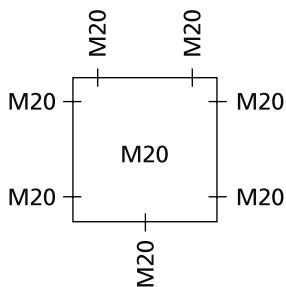

Junction box - Industrial Quality - acc. to DIN EN 60670 (VDE 0606), $U_i=690V$, weatherproof, shock-proof, halogen-free, with self-sealing, soft inlet membranes, M20, seal range 2 - 16 mm



Abox-i 040 AB-L Grey, without terminal	494 904 01
Abox-i 040 AB-4² Grey, screw terminal, 5-pole - 2.5/4 mm² (4 x 1.5² / 4 x 2.5² / 3 x 4²)	494 404 01
Abox-i 040 SB AB-L red cover, without terminal, for identifying circuits for safety lighting	494 707 01
Abox-i 040 AB-L/sw black, without terminal	491 905 01

Abox-i 060

110 x 110 x 67 mm

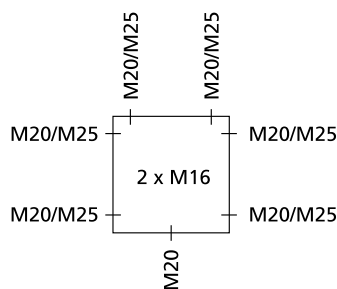

Description

Order no.

Junction box - **Industrial Quality** - acc. to DIN EN 60670 (VDE 0606), $U_i=690V$, weatherproof, shock-proof, halogen-free, with IP66 double-membrane seals, M25, seal range 9 - 16 mm

IP65

6²

IK08

690V
AC**Abox-i 060-L**

Grey, without terminal

490 906 01

Abox-i 060-6²Grey, with high-set screw terminal, 5-pole - 6 mm² (4 x 2.5² / 4 x 4² / 3 x 6²)

490 406 01

Abox-i 060-L/sw

black, without terminal

491 906 01

Abox-i 060-6²/swblack, with high-set screw terminal, 5-pole - 6 mm² (4 x 2.5² / 4 x 4² / 3 x 6²)

491 406 01

Abox-i 100

140 x 140 x 79 mm

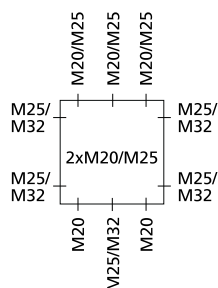

Junction box - **Industrial Quality** - acc. to DIN EN 60670 (VDE 0606), $U_i=690V$, weatherproof, shock-proof, halogen-free, with IP66 double-membrane seals, M32, seal range 14 - 21 mm

IP65

10²

IK08

690V
AC**Abox-i 100-L**

Grey, without terminal

490 910 01

Abox-i 100-10²Grey, with high-set screw terminal, 5-pole - 10 mm² (4 x 4² / 4 x 6² / 4 x 10²)

490 410 01

Abox-i 100-L/sw

black, without terminal

491 910 01

Abox-i 100-10²/swBlack, with high-set screw terminals, 5-pole - 10 mm² (4 x 4² / 4 x 6² / 4 x 10²)

491 410 01

Abox-i 160
180 x 180 x 91 mm

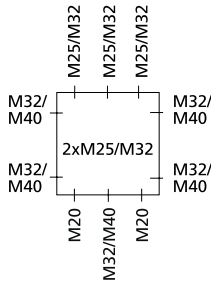

Description

Order no.

Junction box - **Industrial Quality** - acc. to DIN EN 60670 (VDE 0606), $U_i=690V$, weatherproof, shock-proof, halogen-free, with sealing kit, for suitable cable in-feeds see accessories



Abox-i 160-L Grey, without terminals	490 916 01
Abox-i 160-16² Grey, with high-set screw terminal, 5-pole - 16 mm² (4 x 6² / 4 x 10² / 4 x 16²)	490 416 01
Abox-i 160-L/sw Black, without terminals	491 916 01
Abox-i 160-16²/sw Black, with high-set screw terminals, 5-pole - 16 mm² (4 x 6² / 4 x 10² / 4 x 16²)	491 416 01

Abox-i 250
250 x 200 x 115 mm

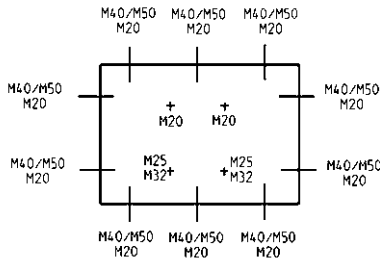

Junction box - **Industrial Quality** - acc. to DIN EN 60670 (VDE 0606), $U_i=690V$, weatherproof, shock-proof, halogen-free, with sealing kit, for suitable cable in-feeds see accessories



Abox-i 250-L Grey, without terminals	490 925 01
Abox-i 250 25² Grey, with high-set screw terminal, 5-pole - 25 mm² (4 x 10² / 4 x 16² / 4 x 25²)	490 425 01

Abox-i 350

250 x 250 x 115 mm

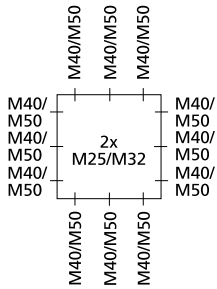

Description

Order no.

Junction box - **Industrial Quality** - acc. to DIN EN 60670 (VDE 0606), $U_i=690V$, weatherproof, shock-proof, halogen-free, with sealing kit, for suitable cable in-feeds see accessories

IP65

35²

IK08



690V
AC



Abox-i 350-L

Grey, without terminals

490 935 01

Abox-i 350-35²

Grey, with high-set screw terminal, 5-pole - 35 mm²
(4 x 10² / 4 x 16² / 4 x 25² / 4 x 35²)

490 435 01

Abox-i 350-L/sw

Black, without terminals

491 935 01

Abox-i 350-35²/sw

Black, with high-set screw terminals, 5-pole - 35 mm²
(4 x 10² / 4 x 16² / 4 x 25² / 4 x 35²)

491 435 01

Abox-i 700

440 x 320 x 179 mm



Entries end:
8 x M20/M25
2 x M32/M40
1 x M40/M50
Entries on each side:
4 x M16
3 x M40/M50

Junction box - **Industrial Quality**, $U_i=690V$, weatherproof, shock-proof, halogen-free, sealable, for suitable cable in-feeds see accessories

IP65

70²

IK08



690V
AC



Abox-i 700-70²

Grey, with 4-pole terminal blocks 4 x 70 mm², 16 - 70²

490 470 01

Accessories

Abox 700 KLS-70²

1-pole - 70 mm²

840 070 01

GKE 32

Side of enclosure 320 mm, for 2 x 75 mm Ø cables

073 032 01

GKE 43

Side of enclosure 440 mm, for 3 x 75 mm Ø cables

073 043 01

Clamping capacity 48-51

Abox-i 1500

440 x 320 x 179 mm



Entries end:
8 x M20/M25
2 x M32/M40
1 x M40/M50
Entries on each side:
4 x M16
3 x M40/M50

Description

Order no.

Junction box - Industrial Quality, $U^i=690V$, weatherproof, shock-proof, halogen-free, sealable, special screw terminal for conductor entry on top, per pole up to 2 x 150² or 4 x 70², for suitable cable in-feeds see accessories

IP65

150²

IK08



690V
AC



Abox-i 1500-150²

Grey, 4-pole - 50 up to 2 x 150 mm², AL/CU

490 485 01

Accessories

AKL 125
250 A

076 125 01

GKE 43
Side of enclosure 440 mm, for 3 x 75 mm Ø cables

073 043 01

GTi 1-g
with grey cover

010 401 01

GFL 20

072 200 01

GZE 3
Side of enclosure 320 mm, for 1 x 75 mm cable

073 003 01

GKE 32
Side of enclosure 320 mm, for 2 x 75 mm Ø cables

073 032 01

GFG 3
Side of enclosure 320 mm, with sealing

072 803 01

Clamping capacity 48-51

Abox-i 1500 DK

440 x 320 x 179 mm



Entries end:
8 x M20/M25
2 x M32/M40
1 x M40/M50
Entries on each side:
4 x M16
3 x M40/M50

Junction box - Industrial Quality, $U^i=690V$, weatherproof, shock-proof, halogen-free, with terminal block mounting, for suitable cable in-feeds see accessories

IP65

150²

IK08



690V
AC



Abox-i 1500 DK-150²

Grey, with 4-pole terminal strip 50 - 150 mm²

490 585 01

Accessories

AKL 125
250 A

076 125 01

GKE 43
Side of enclosure 440 mm, for 3 x 75 mm Ø cables

073 043 01

GTi 1-g
with grey cover

010 401 01

GFL 20

072 200 01

GZE 3
Side of enclosure 320 mm, for 1 x 75 mm cable

073 003 01

GKE 32
Side of enclosure 320 mm, for 2 x 75 mm Ø cables

073 032 01

GFG 3
Side of enclosure 320 mm, with sealing

072 803 01

Clamping capacity 48-51

Abox-i 2400

640 x 320 x 179 mm

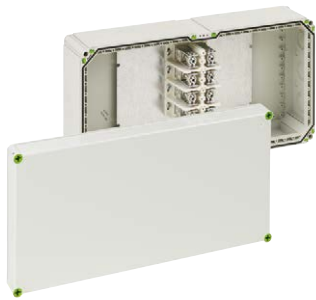

Entries end:
8 x M16
6 x M40/M50
Entries on each side:
4 x M16
3 x M40/M50

Description

Order no.

Junction box - Industrial Quality, $U_i=690V$, weatherproof, shock-proof, halogen-free, sealable, special screw terminal for conductor entry on top, per pole up to 2 x 185²/240² or 4 x 120², for suitable cable in-feeds see accessories

IP65

240²

IK08



690V
AC



Abox-i 2400-240²

Grey, 4-pole - 50 up to 2 x 240 mm², AL/CU

490 494 01

Accessories

AKL 125
250 A

076 125 01

GKE 43
Side of enclosure 440 mm, for 3 x 75 mm Ø cables

073 043 01

GTi 1-g
with grey cover

010 401 01

GFL 20

072 200 01

GZE 3
Side of enclosure 320 mm, for 1 x 75 mm cable

073 003 01

GKE 32
Side of enclosure 320 mm, for 2 x 75 mm Ø cables

073 032 01

GFG 3
Side of enclosure 320 mm, with sealing

072 803 01

Clamping capacity 48-51

Abox-i 2400 DK

640 x 320 x 179 mm

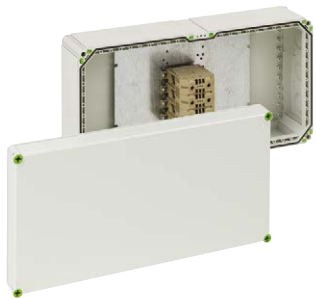

Entries end:
8 x M16
6 x M40/M50
Entries on each side:
4 x M16
3 x M40/M50

Junction box - Industrial Quality, $U_i=690V$, weatherproof, shock-proof, halogen-free, sealable, with terminal block mounting, for suitable cable in-feeds see accessories

IP65

240²

IK08



690V
AC



Abox-i 2400 DK-240²

Grey, with 4-pole terminal strip 70 - 240 mm²

490 594 01

Accessories

AKL 125
250 A

076 125 01

GKE 43
Side of enclosure 440 mm, for 3 x 75 mm Ø cables

073 043 01

GTi 1-g
with grey cover

010 401 01

GFL 20

072 200 01

GZE 3
Side of enclosure 320 mm, for 1 x 75 mm cable

073 003 01

GKE 32
Side of enclosure 320 mm, for 2 x 75 mm Ø cables

073 032 01

GFG 3
Side of enclosure 320 mm, with sealing

072 803 01

Clamping capacity 48-51



**G. SPELSBERG
JUNCTION BOX SERIES ABOX-I
WITH ACCESSORIES**

✓ **Resistance to Ammonia**
DLG Test Report 6398



- The Abox-i SL combines the wiring philosophy of the Abox series with screwless terminal technology.
- Standard installation in wet rooms
- Installation on flammable surfaces
- Installation in agricultural and horticultural premises
- Installation in areas with increased requirements for vibration and shock resistance
- Quick installation thanks to screwless terminal technology
- Maintenance-free
- Vibration- and shock-proof

*SL = Screwless terminal technology



Junction boxes Abox-i SL*

www.spelsberg.com

Abox-i SL-2,5/4²

110 x 110 x 67 mm

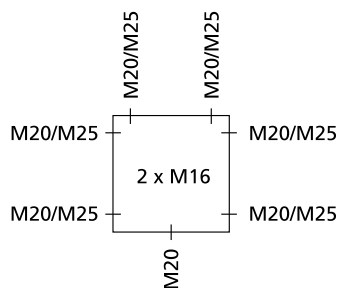

Description

Order no.

Junction box - Industrial Quality - acc. to DIN EN 60670-1/-22, weatherproof, shock-proof, halogen-free, with IP66 double-membrane seals, M25, seal range 9 - 18.5 mm, for suitable cable in-feeds see accessories

IP65

4²

IK08

400V
AC**Abox-i SL-2,5/4²**

Grey, with 5-pole high-set screwless terminal, for current carrying capacity of 24 A, max. cross-section acc. DIN EN 60998:4 mm², cross sections that can be clamped per pole: 3 x 0.2 up to 4 mm² rigid and 3 x 0.14 up to 4.0 mm² flexible

490 106 01

Abox-i SL-2,5-KT

Grey, with high-set terminal carrier, without terminal

490 196 02

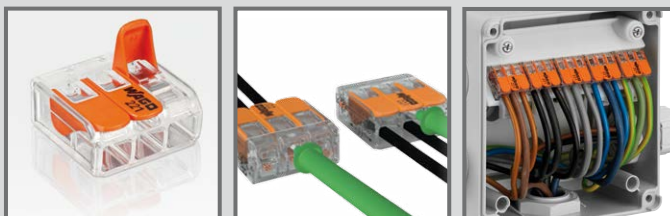
**Abox-i SL-6²**

140 x 140 x 79 mm

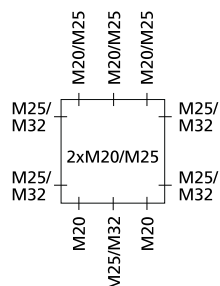

Junction box - Industrial Quality - acc. to DIN EN 60670-1/-22, U_i=690V, weatherproof, shock-proof, halogen-free, with IP66 double-membrane seals, M32, seal range 14 - 21 mm

IP65

6²

IK08

690V
AC**Abox-i SL-6²**

Grey, with 5-pole high-set screwless terminal, max. cross-section acc. EN 60998: 6 mm², for current carrying capacity of 41 A, cross sections that can be clamped per pole: 4 x 0.5 up to 10 mm² rigid and flexible

490 810 01

Abox-i SL-10²
180 x 180 x 91 mm

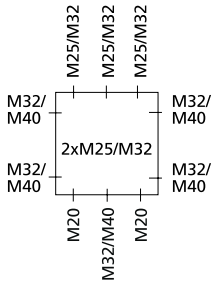

Description

Order no.

Junction box - Industrial Quality - acc. to DIN EN 60670-1/-22, U_i=690V, weatherproof, shock-proof, halogen-free, with sealing kit, for suitable cable in-feeds see accessories



Abox-i SL-10²
Grey, with 5-pole high-set screwless terminal, max. cross-section acc. EN 60998: 10 mm², for current carrying capacity of 57 A, cross sections that can be clamped per pole: 4 x 0.5 up to 16 mm² rigid and flexible

490 816 01

Abox-i SL-16²
250 x 200 x 115 mm

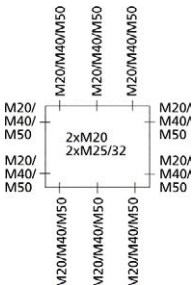

Junction box - Industrial Quality - acc. to DIN EN 60670-1/-22, U_i=690V, weatherproof, shock-proof, halogen-free, with sealing kit, for suitable cable in-feeds see accessories



Abox-i SL-16²
Grey, with 5-pole high-set screwless terminal, max. cross-section acc. EN 60998: 16 mm², for current carrying capacity of 76 A, cross sections that can be clamped per pole: 4 x 0.5 up to 16 mm², rigid, 4 x 0.5 up to 25 mm² flexible

490 835 01



- Simple reinstallation as the cast resin is easy to remove
- Testing in accordance with DIN EN 60 529, IP 68, 168 h to a water depth of 15 metres
- Testing in accordance with DIN VDE 0278-623, sleeve tests up to 0.6 / 1 kV
- For cable cross-sections of 1.5 to 10 mm²
- Impact-resistant and shatterproof, flame retardant
- UV- and weather-resistant

► The box can be filled cleanly using mixing bags and funnels

Applications & use

- Areas subject to flooding
- Washing systems
- Tunnels
- Port facilities

The **Abox XT** series can defy even the presence of standing water in extreme cases



Junction boxes *Abox XT*

Abox XT 025-2,5²
80 x 80 x 52 mm

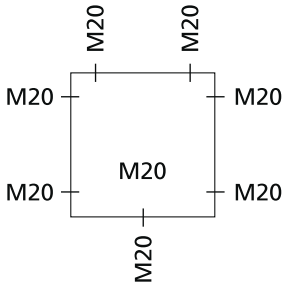

Description

Order no.

Junction box - **Industrial Quality** - with connecting terminals for encapsulating acc. DIN EN 60670 and DIN EN 60529, weather-resistant and shockproof, for the assembly in flooded areas and in the ground without traffic loads, Uⁱ=690V, with self-sealing, soft inlet membranes, M20, seal range 2 - 16 mm, with cast resin bag 250 ml (marking-free), funnel, ventilation seals and disposable gloves, Attention: Note the expiration date of the cast resin bag

IP68 2,5² IK08 690V AC

Abox XT 025-2,5² 492 402 01
Grey, with screw terminal, 5-pole - 2.5 mm² (4 x 1.5² / 4 x 2.5²)

Accessories

GHB 1 492 502 01
Cast-resin bag

Abox XT 040-4²
93 x 93 x 55 mm

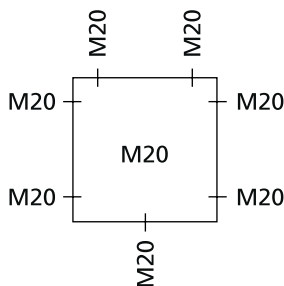

Junction box - **Industrial Quality** - with connecting terminals for encapsulating acc. DIN EN 60670 and DIN EN 60529, weather-resistant and shockproof, for the assembly in flooded areas and in the ground without traffic loads, Uⁱ=690V, with self-sealing, soft inlet membranes, M20, seal range 2 - 16 mm, with cast resin bag 350 ml (marking-free), funnel, ventilation seals and disposable gloves, Attention: Note the expiration date of the cast resin bag

IP68 4² IK08 690V AC

Abox XT 040-4² 492 404 01
Grey, with screw terminal, 5-pole - 2.5/4 mm² (4 x 1.5² / 4 x 2.5² / 3 x 4²)

Accessories

GHB 2 492 504 01
Cast-resin bag

Abox XT 060-6²

110 x 110 x 67 mm

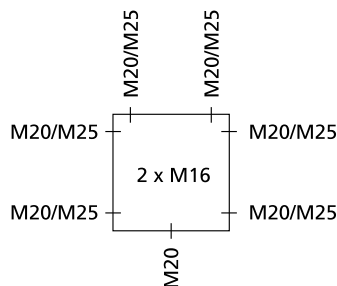

Description

Order no.

Junction box - **Industrial Quality** - with connecting terminals for encapsulating acc. DIN EN 60670 and DIN EN 60529, weather-resistant and shockproof, for the assembly in flooded areas and in the ground without traffic loads, U^I=690V, with double-membrane seals M25, seal range 9 - 16 mm, with cast resin bag 600 ml (marking-free), funnel, ventilation seals and disposable gloves, Attention: Note the expiration date of the cast resin bag

IP68

6²

IK08

690V
AC**Abox XT 060-6²**Grey, with high-set screw terminal, 5-pole - 6 mm² (4 x 2.5² / 4 x 4² / 3 x 6²)

492 406 01

Accessories**GHB 3**

Cast-resin bag

492 506 01

Abox XT 100-10²

140 x 140 x 79 mm

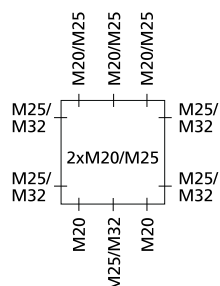

Junction box - **Industrial Quality** - with connecting terminals for encapsulating acc. DIN EN 60670 and DIN EN 60529, weather-resistant and shockproof, for the assembly in flooded areas and in the ground without traffic loads, U^I=690V, with double-membrane seals M32, seal range 14 - 21 mm, with cast resin bag 1200 ml (marking-free), funnel, ventilation seals and disposable gloves, Attention: Note the expiration date of the cast resin bag

IP68

10²

IK08

690V
AC**Abox XT 100-10²**Grey, with high-set screw terminal, 5-pole - 10 mm² (4 x 4² / 4 x 6² / 4 x 10²)

492 410 01

Accessories**GHB 4**

Cast-resin bag

492 510 01

Abox HA 250

250 x 250 x 115 mm

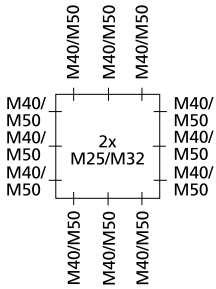

Description

Order no.

Junction box acc. to DIN EN 60670 (VDE 0606), with main cable junction terminal, 25 mm², with IP54 attachment bushes, with blanking plug M40, with twist nipple M50, screw terminal 4-pole 25 mm², Input per pole 2 x 25 mm², Output per pole 4 x 16 mm², with sealing kit

IP65
IP54

25²

IK07



690V
AC



Abox HA 250

Grey, with 4 pole screw terminal 25 mm²

480 425 01

Abox HA 350

250 x 250 x 115 mm

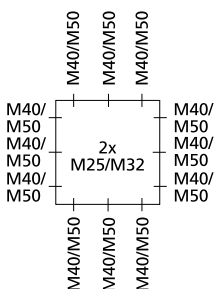

Junction box acc. to DIN EN 60670 (VDE 0606), with main cable junction terminal, 35 mm², with IP54 attachment bushes, with blanking plug M40, with twist nipple M50, screw terminal 4-pole 35 mm², Input per pole 2 x 35 mm², Output per pole 4 x 35 mm², with sealing kit

IP65
IP54

35²

IK07



690V
AC



Abox HA 350

Grey, with 4 pole screw terminal 35 mm²

480 435 01

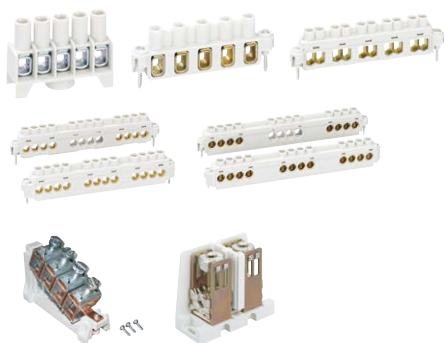
Abox / Abox-i terminals

Description

Order no.

Connecting terminal acc. to DIN EN 60998 (VDE 0613), $U_i=690V$

	Terminals	
Abox 025/040 KLS-2,5²/4²	5-pole - 2.5/4 mm ²	840 004 01
Abox 060 KLS-6²	5-pole - 6 mm ²	840 006 01
Abox 100 KLS-10²	5-pole - 10 mm ²	840 010 01
Abox 160 KLS-16²	5-pole - 16 mm ²	840 016 01
Abox 250/350 KLS-25²/35²	5-pole - 35 mm ²	840 035 01
Abox 700 KLS-70²		840 070 01
AKL 125	1-pole - 150 mm ²	076 125 01
AKL 140	1-pole - 240 mm ²	076 140 01

Abox PST

Sealing set

Abox PST for junction boxes Abox/Abox-i 025 to 100, (from Abox/Abox-i 160, contained as standard in the delivery)	890 010 01
--	------------

Cable infeeds

Cable entry via module with folded rubber for cables of up to 75 mm diameter for Abox-i 700 / 1500 / 2400 series



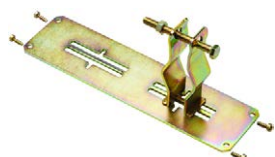

GKE 32 Side of enclosure 320 mm, for 2 x 75 mm Ø cables	073 032 01
GKE 43 Side of enclosure 440 mm, for 3 x 75 mm Ø cables	073 043 01

Strain reliefs

Cable strain relief for cables up to 75 mm for Abox-i 2400 series

GZE 3 Side of enclosure 320 mm, for 1 x 75 mm cable	073 003 01
GZE 4 Side of enclosure 440 mm, for 1 x 75 mm cable	073 004 01

Colors

	grey	similar RAL 7035
	green	similar RAL 6018
	red	similar RAL 3020
	black	similar RAL 9005
	white	similar RAL 9010



Standard rails

35 mm



Description

Order no.

Standard rail acc. to DIN EN 60715, 35 x 7.5, width 35 mm, incl. fixing screws

NS 35-81

TK PS/PC 1111/1309/1313/1809/1811 + TK AL 1111/1313/1811, Abox/Abox-i 060

198 081 01

NS 35-106

TK PS/PC 1309/1313 + TK AL 1111/1313, Abox/Abox-i 100

198 106 01

NS35-144/2

Abox/Abox-i 160, Abox/Abox-i 250

894 016 01

NS35-216/2

Abox/Abox-i 350

894 035 01

NS35-216/3

universal floor fixing, length 216 mm, with fixing screws

795 030 01

Mounting plates



Mounting plate made from insulating material, incl. fixing screws

Abox 060 MPI

Enclosure type

Abox/Abox-i 060

895 006 01

Abox 100 MPI

Abox/Abox-i 100

895 010 01

Abox 160 MPI

Abox/Abox-i 160

895 016 01

Abox 250 MPI

Abox/Abox-i 250

895 025 01

Abox 350 MPI

Abox/Abox-i 350

895 035 01

AK MPI 3

AKL/AKi 3-4

795 003 01

GMI 3

Abox-i 700

071 013 01

Mounting plate cable tray

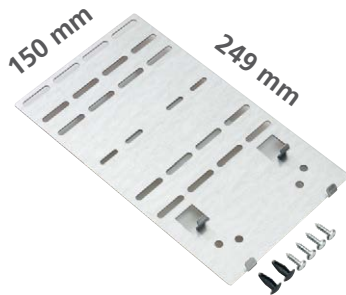





Mounting plate made of sheet steel, incl. fixing screws, for mounting on Stago/van Geel cable tray, for mounting of Abox junction boxes, fastening space of up to 130 mm

MPS-KRI

194 101 01





						
Art. no. terminal	840 004 01 Abox 025/40 KLS 2,5 ² /4 ²	840 006 01 Abox 060 KLS 6 ²	840 010 01 Abox 100 KLS 10 ²	840 016 01 Abox 160 KLS 16 ²		
Installed in junction box	Abox 025-2,5 ² Abox 025 AB-2,5 ² Abox-i 025-2,5 ² Abox-i 025-2,5 ² /sw Abox 040-4,0 ² Abox 040-4,0 ² /w Abox 040 AB-4,0 ² Abox-i 040-4,0 ² Abox-i 040-4,0 ² /sw	Abox 060-6 ² Abox-i 060-6 ² Abox-i 060-6 ² /sw Abox 100-10 ² Abox-i 100-10 ² Abox-i 100-10 ² /sw Abox 160-16 ² Abox-i 160-16 ² Abox-i 160-16 ² /sw	Abox 350-35 ² Abox-i 350-35 ² Abox-i 350-35 ² /sw	Abox 060-6 ² Abox-i 060-6 ² Abox-i 060-6 ² /sw	Abox 100-10 ² Abox-i 100-10 ² Abox-i 100-10 ² /sw	Abox 160-16 ² Abox-i 160-16 ² Abox-i 160-16 ² /sw
Rated connection capacity	6 mm ²	10 mm ²	16 mm ²	25 mm ²		
Rated insulation voltage [V]	690	690	690	690		
Rated current [A]	41	57	76	101		
Clamping points per pole	1	1	2	4		
Number of conductors in a clamping point, conductor cross-section, type of conductor	1..5 x 1,5 ² re 1..6 x 2,5 ² re 1..4 x 4 ² re 1..2 x 6 ² re	1...5 x 2,5 ² re 1...5 x 4 ² re 1...4 x 6 ² re 1...2 x 10 ² re	1..8 x 2,5 ² re 1..6 x 4 ² re 1..4 x 6 ² re 1..2 x 10 ² re 1 x 16 ² re	1..6 x 4 ² re 1..4 x 6 ² re 1..2 x 10 ² re 1 x 16 ² re 1 x 25 ² re		
Type of conductor	Cu	Cu	Cu	Cu		
Number of poles	5	5	5	5		
Stripped length	11 mm	11 mm	11 mm	11 mm		
Tightening torque	1,2 Nm	2,0 Nm	2,0 Nm	2,5 Nm		
Type of terminal	Screw terminal M4	High-position screw terminal M5	High-position screw terminal M5	High-position screw terminal M6		









re= single-wire, round conductor



se= single-wire, sector conductor







rm= multi-wire, round conductor

						
840 035 01 Abox 250/350 KLS 25 ² /35 ²	840 070 01 Abox 700 KLS 70 ²	076 125 01 AKL 125150 ²	670 650 01 URS RK1 150 ²	670 740 01 URS RK1 240 ²	076 140 01 AKL 140 240 ²	460 525 01 WK 007 KLS-2,5 ²
Abox 250-25 ² Abox-i 250-25 ² Abox 350-35 ² Abox-i 350-35 ² Abox-i 350-35 ² /sw	Abox 700-70 ² Abox-i 700-70 ²	Abox-i 1500-150 ²	Abox-i 1500-150 ² DK	Abox-i 2400-240 ² DK	Abox-i 2400-240 ²	WK 007-2,5 ²
35 mm ²	70 mm ²	150 mm ²	150 mm ²	240 mm ²	240 mm ²	2,5 mm ²
690	690	690	1000	1000	690	660
125	150	250	309	380	400	24
4	4	4	2	2	4	1
1..4 x 10 ² re 1..2 x 16 ² re 1 x 25 ² re 1 x 35 ² re	1x16 ² re;rm;se;sm 1x25 ² re;rm;se;sm 1x35 ² re;rm;se;sm 1x50 ² re;rm;se;sm 1x70 ² re;rm;se;sm	Cu/AL 1x16-50 re, Cu/AL1x16-150 rm, Cu/AL1x50-150 se, Cu 1x35-150 sm, AL 1x50-120 sm, Cu/AL 2x16-50 re, Cu/AL 2x16-70 rm, Cu/AL 2x50-70 se, Cu 2x35-70 sm, AL 2x35-50 sm	eindrchtig starr 35-150 / mehrdrchtig flexibel 50-150 feindrchtig 50-150 / feindrchtig Aderend- hule 50-150 Bandleiter bis 20x8	eindrchtig starr 50-240 / mehrdrchtig flexibel 50-240, feindrchtig 50-240 / feindrchtig Aderendhule 50-240 Bandleiter bis 20x12	1x25-50 re Al Cu, 1x25-240 rm Cu, 1x50-185 se Al Cu, 1x35-240 sm Cu, 1x95-185 sm Al, 2x25-50 re Cu Al, 2x25-120 rm Cu Al, 2x50-120 se Al Cu, 2x35-120 sm Cu, 2x50-95 sm Al, Flach Cu 25x15	6 x 1 ² -1,5 ² re,rm 4 x 2,5 ² re, rm
Cu	Cu	Cu/AL	Cu	Cu	Cu/AL	Cu
5	1	1	1	1	1	5
11 mm	15 mm	38 mm	38 mm	37 mm	45 mm	11 mm
4,0 Nm	4,0 Nm	20 Nm	10-20 Nm	10-20 Nm	40 Nm	1,2 Nm
High-position screw terminal M8	Screw terminal	Screw terminal cable insertion from above	Serial through-feed terminal M10 Allen head	Serial through-feed terminal M10 Allen head	Screw terminal cable insertion from above	Screw terminal



sm= multi-wire, sector conductor

					
Art. no. terminal	460 506 01 WK 060 KLS-6 ²	460 510 01 WK 100 KLS-10 ²	460 516 01 WK 160 KLS-16 ²	460 535 01 WK 250 KLS-25 ²	076 125 01 AKL 125
Installed in junction box	WK 060-6 ²	WK 100-10 ²	WK 160-16 ²	WK 250-25 ²	Abox-i 1500-150 ²
Rated connection capacity	6mm ²	10mm ²	16mm ²	25mm ²	150mm ²
Rated insulation voltage [V]	690	690	690	690	1000
Rated current [A]	41	57	76	101	250
Clamping points per pole	1	1	1	1	2
Number of conductors in a clamping point, conductor cross-section, type of conductor	3 x 2,5 ² -6 ² re, rm	3 x 4 ² -10 ² re, rm	3 x 6 ² -16 ² re, rm	3 x 10 ² -25 ² re, rm	Cu/Al 1x16-50 re, Cu/Al 1x16-150 rm, Cu/Al 1x50-150 se, CU 1x35-150 sm, Al 1x50-150 sm, Cu/Al 2x16-50 re, Cu/Al 2x16-70 rm, Cu/Al 2x50-70 se, CU 2x35-70 sm, Al 2x35-50 sm
Type of conductor	Cu	Cu	Cu	Cu	Cu / AL
Number of poles	5	5	5	5	1
Stripped length	15 mm	15 mm	23 mm	28 mm	-----
Tightening torque	2,0 Nm	2,0 Nm	2,5 Nm	2,5 Nm	20 Nm
Type of terminal	Screw terminal	Screw terminal	Screw terminal	Screw terminal	Screw terminal







re= single-wire, round conductor



se= single-wire, sector conductor



rm= multi-wire, round conductor

				
076 140 01 AKL 140	-----	-----	-----	-----
Abox-i 2400-240²	Abox SL 2,5² Abox-i SL 2,5/4²	Abox SL 6² Abox-i SL 6²	Abox SL 10² Abox-i SL 10²	Abox SL 16² Abox-i SL 16²
240mm²	4mm²	6mm²	10mm²	16mm²
1000	450	800	800	800
400	32	41	57	76
2	3	2	2	2
Cu/Al 1x25-50 re, Cu/Al 1x25-240 rm, Cu/Al 1x50-185 se, CU 1x35-240 sm, Al 1x95-185 sm, Cu/Al 2x25-50 re, Cu/Al 2x25-120 rm, Cu/Al 2x50-120 se, CU 2x35-120 sm, Al 2x50-95 sm	Single wire 0.2-4² Multi-wire 0.2-4² Fine-wire 0.14-4²	Single wire 0.5-10² Fine-wire 0.5-10² Fine-wire wire end ferrule 1.5²	Single wire 0.5-16² Fine wire 0.5-16² Fine-wire wire end ferrule 2.5²	Single wire 0.5-16² Fine-wire 0.5-25² Fine-wire wire end ferrule 2.5²
Cu / AL	Cu	Cu	Cu	Cu
1	1	1	1	1
-----	11 mm	15 mm	19 mm	20 mm
20 Nm	-----	-----	-----	-----
Screw terminal	Push-in terminal	Spring-type terminal	Spring-type terminal	Spring-type terminal



sm= multi-wire, sector conductor



- Mounting on wood or other combustible materials
- Safe opening and closing mechanism
- Colour variants (sw=black / sb=red / gr=green) for reliable identification of circuits
- Knock-out entries can be removed with a knife
- Patented external mounting bracket
- Labelling area

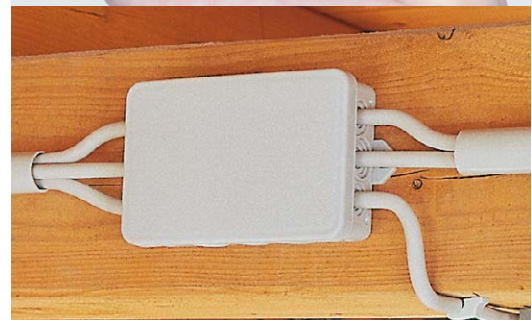
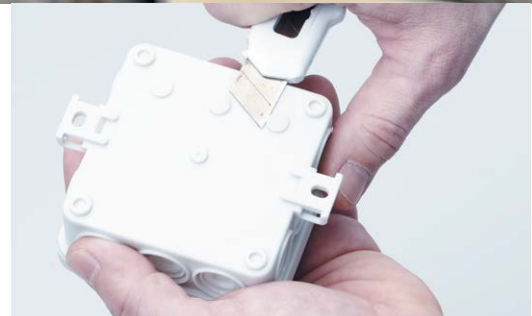

IP55
2,5²
IK07

400V AC

Junction boxes Red Range

Mini 25

89 x 43 x 37 mm

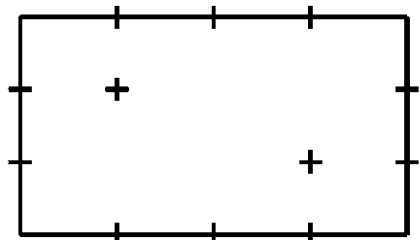

Description

Order no.

Junction box acc. to DIN EN 60670 (VDE 0606), 10 entries, 2 floor entries, suitable for confined installation environments such as suspended ceilings and cable ducts, complete with punching tool and blanking plug, with external fixing positions

IP55

2,5²

IK07

400V
AC**Mini 25-L**

Grey, without terminals, for VDE approved single terminals

310 908 01

Mini 25-2,5²Grey, with 3 interlockable screw terminals 2.5 mm²

310 408 01

Sd 7

75 x 75 x 37 mm

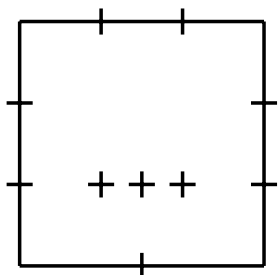

Junction box acc. to DIN EN 60670 (VDE 0606), 7 entries, 3 floor entries, complete with punching tool and blanking plug, with external fixing positions

IP55

2,5²

IK07

400V
AC**Sd 7-L**

Grey, without terminals, for VDE approved single terminals

332 907 01

Sd 7-2,5²Grey, with 5 interlockable screw terminals 2.5 mm²

332 407 01

Sd 7 SB-L

Red, without terminals, for VDE approved single terminals, for identifying circuits for safety lighting

332 707 01

i 12

85 x 85 x 37 mm

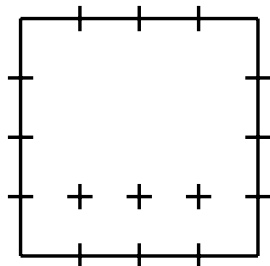

Description

Order no.

Junction box acc. to DIN EN 60670 (VDE 0606), 12 entries, 3 floor entries, complete with punching tool and blanking plug, with external fixing positions

IP55

2,5²

IK07

400V
AC**i 12-L**

Grey, without terminals, for VDE approved single terminals

332 912 01

i 12 -2,5²/wWhite, with 5 modular screw terminals 2.5 mm²

332 112 01

i 12-2,5²Grey, with 5 interlockable screw terminals 2.5 mm²

332 412 01

i 12-L/w

White, without terminals, for VDE approved single terminals

332 612 01

i 12 SB-L

Red, without terminals, for VDE approved single terminals, for identifying circuits for safety lighting

332 712 01

i 12-L/gr

Green, without terminals, for VDE approved single terminals, for identifying auxiliary power supply electrical circuits

332 512 01

i 12 -L/sw

Black, without terminals, for VDE approved single terminals

332 212 01

2K-12

85 x 85 x 37 mm

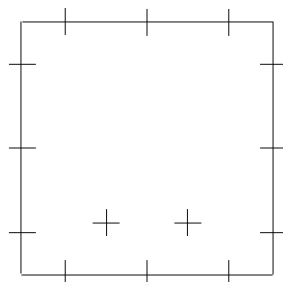

Junction box acc. to DIN EN 60670 (VDE 0606), 12 entries, 2 floor entries, with self-sealing, soft inlet membranes, tools not required for opening the cable entry, seal range 2 - 14 mm, with internal fixing positions

IP55

2,5²

IK07

400V
AC**2K-12-L**

Grey, without terminals, for VDE approved single terminals

344 912 01

2K-12-L/br

Brown, without terminal, for VDE approved single terminals

344 012 01

2K-12-2,5²Grey, with screw terminal 5-pole - 2.5 mm²

344 412 01

2K-12-L/w

White, without terminals, for VDE approved single terminals

344 612 01

2K-12-2,5²/wWhite, with screw terminal 5-pole - 2.5 mm²

344 112 01

2K-12 AB

85 x 85 x 37 mm

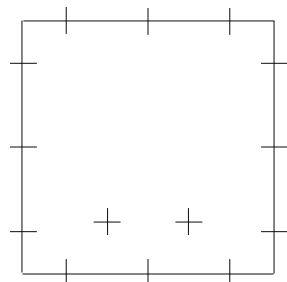

Description

Order no.

Junction box acc. to DIN EN 60670 (VDE 0606), 12 entries, 2 floor entries, with self-sealing, soft inlet membranes, tools not required for opening the cable entry, seal range 2 - 14 mm, with external fixing positions

IP55

2,5²

IK07

400V
AC**2K-12 AB-L**

Grey, without terminals, for VDE approved single terminals

345 912 01

2K-12 AB-2.5²Grey, with screw terminal 5-pole - 2.5 mm², for VDE approved single terminals

345 412 01

2K-12 AB-L/w

White, without terminals, for VDE approved single terminals

345 612 01

2K-12 AB-2,5²/wWhite, with screw terminal 5-pole - 2.5 mm²

345 112 01

i 16

130 x 85 x 37 mm

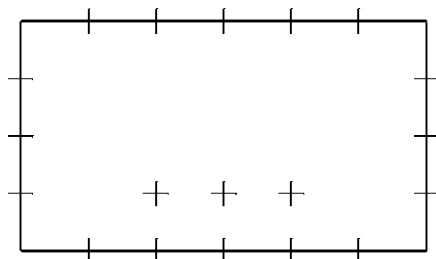

Junction box acc. to DIN EN 60670 (VDE 0606), 16 entries , 3 floor entries, complete with punching tool and blanking plug, with external fixing positions

IP55

2,5²

IK07

400V
AC**i 16-L**

Grey, without terminals, for VDE approved single terminals

333 916 01

i 16-2,5²Grey, with screw terminal 5-pole - 2.5 mm²

333 416 01

2K-16

130 x 85 x 37 mm

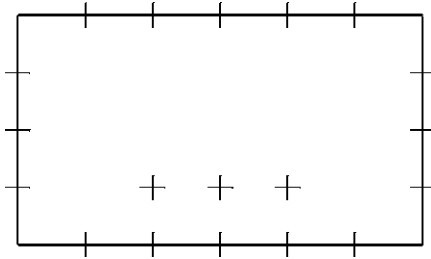

Description

Order no.

Junction box acc. to DIN EN 60670 (VDE 0606), 16 entries, 3 floor entries, with self-sealing, soft inlet membranes, tools not required for opening the cable entry, seal range 2 - 14 mm, with internal fixing positions

IP55

2,5²

IK07



400V
AC



2K-16-L

Grey, without terminals, for VDE approved single terminals

346 916 01

2K-16-2,5²

Grey, with screw terminal 5-pole - 2.5 mm²

346 416 01

2K-16-L/w

White, without terminals, for VDE approved single terminals

346 616 01

2K-16-2,5²/w

White, with screw terminal 5-pole - 2.5 mm²

346 116 01

2K-16 AB

130 x 85 x 37 mm

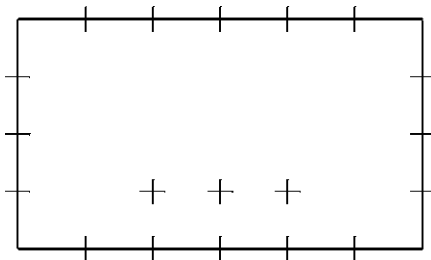

Junction box acc. to DIN EN 60670 (VDE 0606), 16 entries, 3 floor entries, with self-sealing, soft inlet membranes, tools not required for opening the cable entry, seal range 2 - 14 mm, with external fixing positions

IP55

2,5²

IK07



400V
AC



2K-16 AB-L

Grey, without terminals, for VDE approved single terminals

348 916 01

2K-16 AB-2,5²

Grey, with screw terminal 5-pole - 2.5 mm²

348 416 01

2K-16 AB-L/w

White, without terminals, for VDE approved single terminals

348 616 01

2K-16 AB-2,5²/w

White, with screw terminal 5-pole - 2.5 mm²

348 116 01

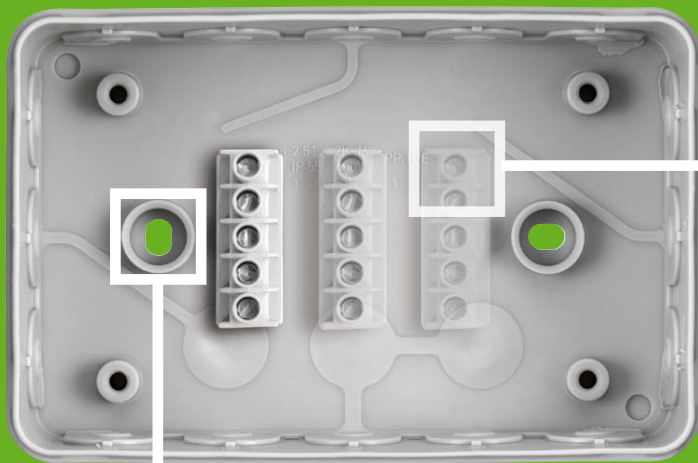

3 fixture points for attaching the screw terminal and the pull relief

Exterior and interior mounting, or with interior mounting only

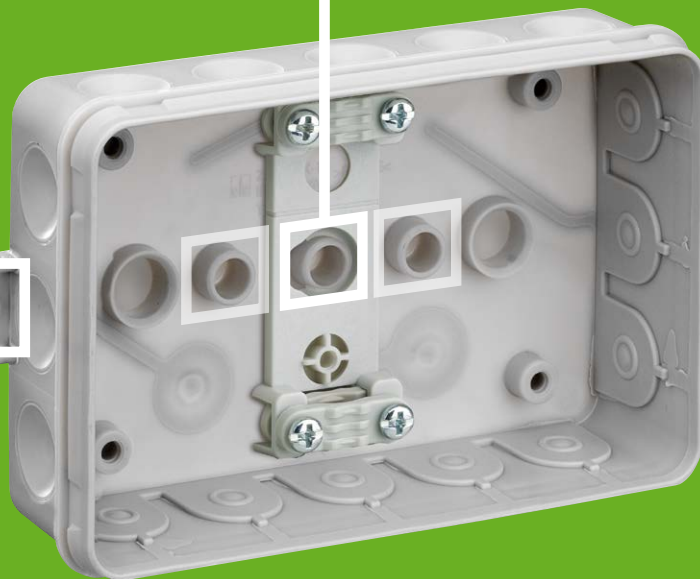

2K-16

2K-16

- Junction box as per DIN EN 60670 (VDE 0606)
- 16 entry points
- 3 base inlets consisting of self-sealing, soft inlet membranes
- With exterior and interior mounting, or with interior mounting only
- 3 fixture points for attaching the screw terminal and the strain relief
- Tool for opening the line inlet not required, sealing range 2-14 mm
- Connection table in the lid
- More secure opening and closing mechanism:
 1. Lockable without tools
 2. Can only be opened with a tool
- With practical labelling strip



Junction boxes **2K-16**

NEW!



- Quick installation with cable entry from above
- Pre-wired circuit can be inserted subsequently
- Strain relief for suspended lights
- Contact protection
- Enclosure height only 23 mm

- An innovation for suspended ceilings and double floors
- Clamping possible outside the box
- VDE-compliant retrofitting of electrical systems

IP30
IP20

2,5²

IK07



400V
AC



www.spelsberg.com

Junction boxes Red Range

Q 4

56 x 40 x 23 mm

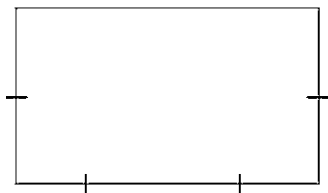

Description

Order no.

Junction box acc. to DIN EN 60598 (VDE 0711), 4 entries , with strain relief acc. VDE 0606 for NYM 3 x 2.5 mm², 2 of which are accessible from the top, Strain relief clamp for pendulum lights (max. 60W), with external fixing positions

IP20

2,5²

IK07

400V
AC

Q 4-L
Grey, without terminal

334 904 01

Q 12

85 x 85 x 37 mm

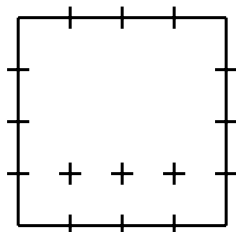

Junction box acc. to DIN EN 60670 (VDE 0606), 12 entries, with conductor retention acc. to VDE 0606 for NYM 5 x 2.5 mm², 7 of which are accessible from the top, 3 floor entries, with external fixing positions

IP20

2,5²

IK07

400V
AC

Q 12-L
Grey, without terminals, for VDE approved single terminals

334 912 01

Q 12-2,5²
Grey, with 5 interlockable screw terminals 2.5 mm²

334 412 01

Q 12 SB-L
Red, without terminals, for VDE approved single terminals, for identifying circuits for safety lighting

334 712 01

AP 7

78 x 78 x 27 mm

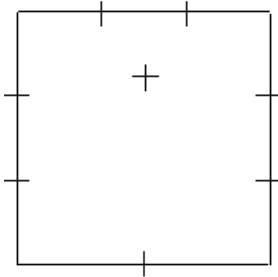

Description

Order no.

Junction box acc. VDE 0606, Surface mounting, 7 entries, 1 bottom entry, central quick lock lid

IP30

2,5²

IK07

400V
AC**AP 7 - L**

White, without terminals, for VDE approved single terminals

315 607 01

AP 7 - 2,5²White, with 5-pole HandyGrip terminal 2.5 mm²

315 107 01

Strain relief ZEL 2K-12

Strain relief, for assembly in 2K-12 junction boxes, Strain relief possible for up to 2 entries, Strain relief can be split without tools, 2 strain relief clamps are required for T wiring

ZEL 2K-12

Grey

344 001 01

UP 6

32 mm Height, Ø 80 mm



IP54

Junction box acc. to DIN EN 60670 (VDE 0606), with self-sealing inlet membranes, with separate flush-fitting lid

UP 6-L

Grey, without terminals, for VDE approved single terminals

306 906 01

UP 6-2,5²Grey, with screw terminal 5-pole - 2.5 mm²

306 406 01

VST RR

Sealing plugs, for subsequent closing of previously opened entries on junction boxes in Red Range

VST RR

Grey

300 407 01



2K-12 with integrated strain relief

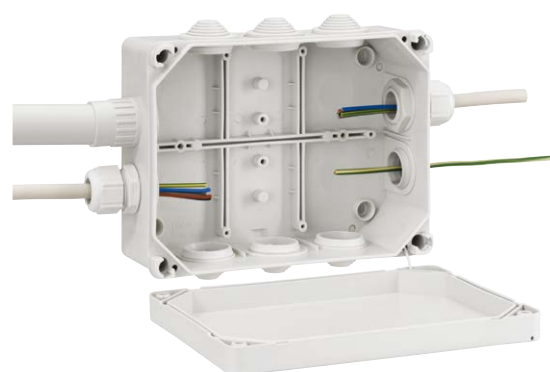

- 6 sizes
- Mounting on wood or other combustible materials
- Mounted stepped nipples
- Cross-sectional area of 1.5 mm² to 10 mm²
- Insertion points are equally suitable for metric mounting accessories

Suitable for installation

- in damp and wet areas and rooms
- in installations for gatherings of people
- in temporary buildings, cars and caravans



Junction boxes HP

HP 70

75 x 75 x 42 mm

Internal dimension: 68 x 68 x 38 mm

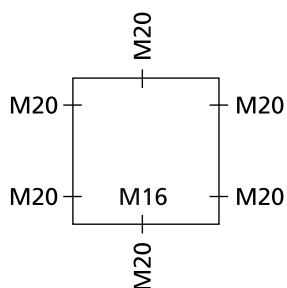

Description

Order no.

Junction box acc. to DIN EN 60670 (VDE 0606), 3 recessed stepped nipples, and two loose ones enclosed, seal range 5 - 16 mm, for terminals up to 2.5 mm²

IP55

2,5²

IK07

400V
AC**HP 70-L**

Grey, without terminals

320 970 01

HP 80

85 x 85 x 42 mm

Internal dimension: 78 x 78 x 38 mm

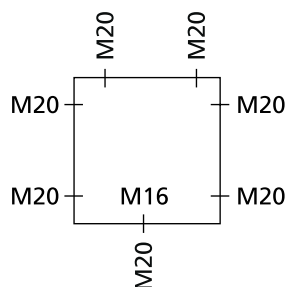

Junction box acc. to DIN EN 60670 (VDE 0606), 7 recessed stepped nipples, seal range 5 - 16 mm, for terminals up to 2.5 mm²

IP55

2,5²

IK07

400V
AC**HP 80-L**

Grey, without terminals

322 980 01

HP 90

90 x 90 x 45 mm
Internal dimension: 82 x 82 x 38 mm

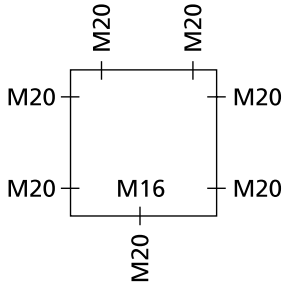

Description

Order no.

Junction box acc. to DIN EN 60670 (VDE 0606), 7 recessed stepped nipples, seal range 5 - 16 mm, for terminals up to 4 mm²

IP55

4²

IK07



400V
AC



HP 90-L

Grey, without terminals

325 990 01

HP 100

113 x 113 x 58 mm
Internal dimension: 103,5 x 103,5 x 32 mm

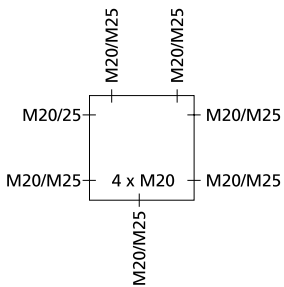

Junction box acc. to DIN EN 60670 (VDE 0606), U_i=690V, 7 recessed stepped nipples, seal range 5 - 21 mm, for terminals up to 10 mm²

IP55

10²

IK07



690V
AC



HP 100-L

Grey, without terminals

326 900 01

HP 150

164 x 119 x 77 mm
Internal dimension: 155 x 110 x 70 mm

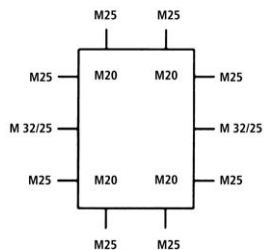

Description

Order no.

Junction box, $U_i=690V$, 10 recessed stepped nipples, seal range 5 - 21 mm

IP55

IK07



690V
AC



HP 150-L

Grey, without terminals, with cover retainer

326 950 01

HP 190

199 x 149 x 77 mm
Internal dimension: 190 x 140 x 70 mm

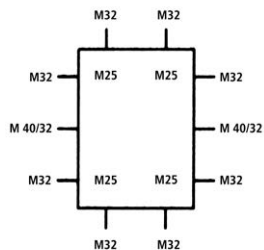

Junction box, $U_i=690V$, 10 recessed stepped nipples, seal range 13 - 26.5 mm

IP55

IK07



690V
AC



HP 190-L

Grey, without terminals, with cover retainer

326 990 01

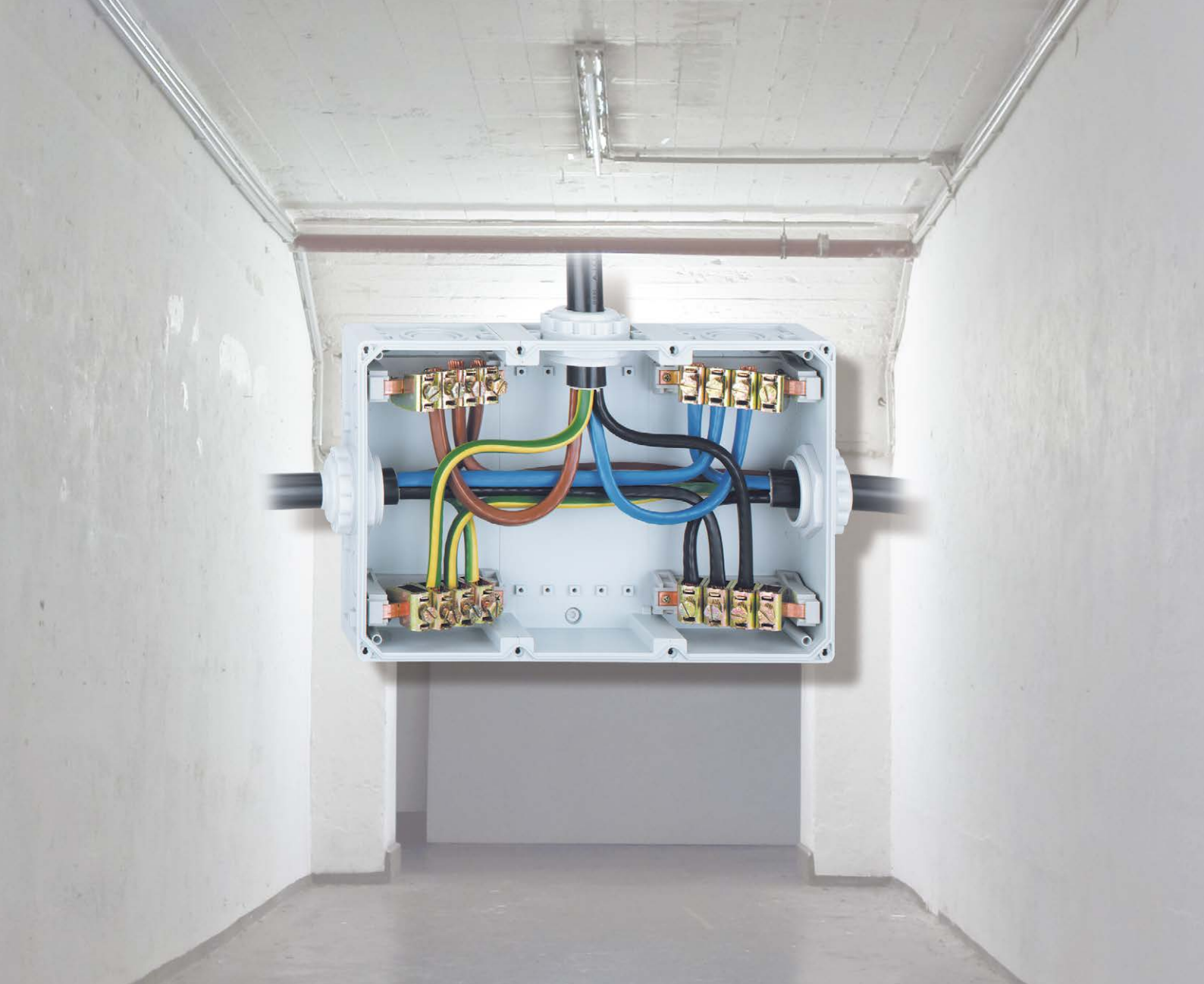

- Halogen-free duroplastic
 - Glow-wire test as per VDE 0471 up to 960°C
 - Cable cross-sections of 2.5² to 25²
- Suitable for use**
- in locations that are subject to fire hazards as per VDE 0100 Part 482

IP54

25²

IK05



400V
690V
AC



Junction boxes WK

WK 007

80 x 80 x 38 mm

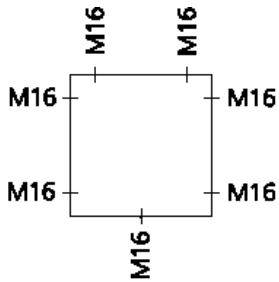

Description

Order no.

Junction box acc. to DIN EN 60670 (VDE 0606), Duroplastic, halogen-free, with IP54 attachment bushes, with blanking plug M16, seal range 6 - 10 mm

IP54

2,5²

IK05

400V
AC**WK 007-L**

Grey, without terminal

402 907 01

WK 007-2,5²Grey, with screw terminal 5-pole - 2.5 mm², (6 x 1.5² / 4 x 2.5²)

402 407 01

WK 040

87 x 87 x 45 mm

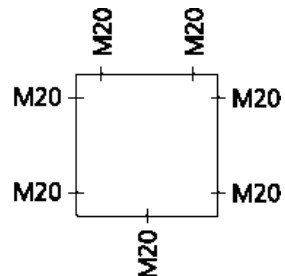

Junction box acc. to DIN EN 60670 (VDE 0606), U_i=690V, Duroplastic, halogen-free, with IP54 attachment bushes, with blanking plug M20, seal range 8 - 13.5 mm

IP54

4²

IK05

690V
AC**WK 040-L**

Grey, without terminal

404 907 01

WK 040-S

Grey, without terminals

455 907 01

WK 040-4²Grey, with screw terminal 5-pole - 4 mm², (6 x 2.5² / 4 x 4²)

404 407 01

WK 060

100 x 100 x 50 mm

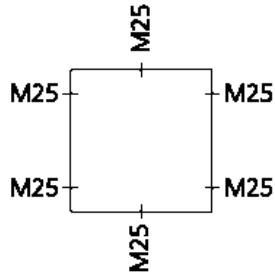

Description

Order no.

Junction box acc. to DIN EN 60670 (VDE 0606), $U_i=690V$, Duroplastic, halogen-free, with IP54 attachment bushes, with blanking plug M25, seal range 9 - 18.5 mm

IP54

6²

IK05

690V
AC**WK 060-L**

Grey, without terminal

406 906 01

WK 060-6²Grey, with 5-pole screw terminal - 6 mm², (5 x 4² / 4 x 6²)

406 406 01

WK 100

115 x 115 x 66 mm

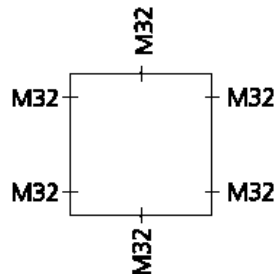

Junction box acc. to DIN EN 60670 (VDE 0606), $U_i=690V$, Duroplastic, halogen-free, with IP54 attachment bushes, with blanking plug M32, seal range 13 - 23 mm, with sealing kit

IP54

10²

IK05

690V
AC**WK 100-L**

Grey, without terminal

410 906 01

WK 100-10²Grey, with 5-pole screw terminal - 10 mm², (5 x 4² / 4 x 6² / 3 x 10²)

410 406 01

WK 160

165 x 165 x 76 mm

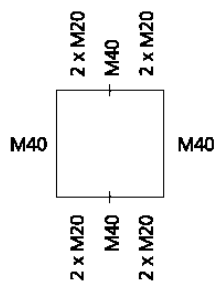

Description

Order no.

Junction box acc. to DIN EN 60670 (VDE 0606), $U_i=690V$, Duroplastic, halogen-free, with IP54 attachment bushes, with blanking plug M40, seal range 17 - 30 mm, with sealing kit

IP54

16²

IK05

690V
AC**WK 160-L**

Grey, without terminal

416 912 01

WK 160-16²Grey, with 5-pole screw terminal - 16 mm², (5 x 10² / 3 x 16²)

416 412 01

WK 250

256 x 171 x 106 mm

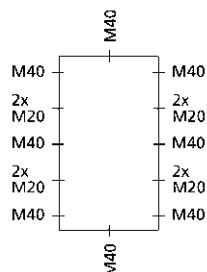

Junction box acc. to DIN EN 60670 (VDE 0606), $U_i=690V$, Duroplastic, halogen-free, with IP54 attachment bushes, with blanking plug M40, seal range 17 - 30 mm, with sealing kit

IP54

25²

IK05

690V
AC**WK 250-L**

Grey, without terminal

425 916 01

WK 250-25²Grey, with 5-pole screw terminal - 25 mm², (5 x 16² / 3 x 25²)

425 416 01

WK Terminal block

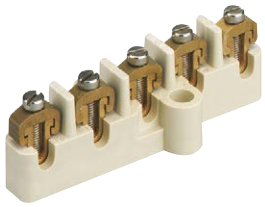

Description

Order no.

Connecting terminal, $U_i=400V / 690V$

	Terminals	Enclosure type	
WK 007 KLS-2,5 ²	5-pole - 2.5 mm ²	WK 007	460 525 01
Abox 025/040 KLS-2,5 ² /4 ²	5-pole - 2.5/4 mm ²	WK 040	840 004 01
WK 060 KLS-6 ²	5-pole - 6 mm ²	WK 060	460 506 01
WK 100 KLS-10 ²	5-pole - 10 mm ²	WK 100	460 510 01
WK 160 KLS-16 ²	5-pole - 16 mm ²	WK 160	460 516 01
WK 250 KLS-25 ²	5-pole - 25 mm ²	WK 250	460 535 01

HandyQuick - 1,5²



Screwless connecting terminal for single-wire conductors acc. to DIN EN 60998 (VDE 0613), $U_i=400 V$

HandyQuick light grey, 3 x 0.75-1.5 mm² SQ 31 688 310 01

HandyQuick - 2,5²



Screwless connecting terminal for single-wire conductors acc. to DIN EN 60998 (VDE 0613), $U_i=400 V$

HandyQuick Dark grey, 3 x 1.0-2.5 mm² SQ 32 688 320 01

HandyQuick Dark grey, 5 x 1.0-2.5 mm² SQ 52 688 520 01

HandyGrip - 2,5²

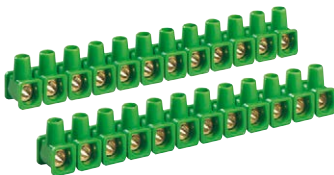

12-pole screw terminal, rated cross-section 2.5 mm², $U_i=400 V$

HandyGrip Sorted according to colour VG 20 685 020 01

HandyGrip Closed on one side, sorted according to colour VG 21 685 021 01

HandyGrip Closed on one site, white VG 21 w 685 121 01

Cable gland



IP68

Description

Cable gland with strain relief, polyamide, M_ x 1.5 mm, with lock nut

Order no.

	Thread length/mm	Sealing area/mm	
KVR M12-MGM	8	2 - 6.5	227 412 01
KVR M16-MGM	8	4 - 10.0	227 416 01
KVR M20-MGM	9	6 - 12.0	227 420 01
KVR M20-GDB/MGM	9	7 - 14.0	227 421 01
KVR M25-MGM	11	9 - 16	227 425 01
KVR M32-MGM	11	11 - 21.0	227 432 01
KVR M40-MGM	11	16 - 28.0	227 440 01
KVR M50-MGM	13	21 - 34.5	227 450 01
KVR M63-MGM	17	30 - 44.5	227 463 01

Double membrane seals



IP66

Double membrane seals made of elastic plastic with two sealing membranes, closed

	f. wall thicknesses/mm	Sealing area/mm	
DMS M16	1.5 - 4.5	5 - 9	260 416 01
DMS M20	1.5 - 4.5	7 - 12	260 420 01
DMS M25	1.5 - 4.5	9 - 16	260 425 01
DMS M32	1.5 - 4.5	14 - 21	260 432 01
DMS M40	1.5 - 4.5	19 - 28	260 440 01



You can rely on our WKE products for maintaining electrical function. For example, we presented the first fire-proof, freely configurable small distributor with the WKE AK. It has a VDE certificate and also meets on-site requirements, giving you space for sure planning.

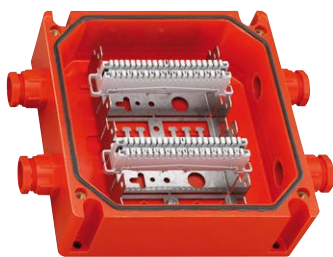

Intrinsic fire resistance

	Protection rating	Max. rated cross-section	Types	Page
	IP54 / IP65	16 mm ²	Cable junction boxes for buildings (E30 - E90) WKE 2 - 5 Duo	74-78
	IP54 / IP65	16 mm ²	Cable junction boxes for buildings (E30 - E90) WKE 1 - 5	79-85
	IP66	35 mm ²	Cable junction boxes (E30) WKE 200 - 400 RK	86-93
	IP66	---	Cable junction boxes (E30) WKE 405 LSA	91
	IP54 / IP65	16 mm ²	Cable junction boxes for buildings (E30 - E90) WKE 2 - 5 SB	94-97
	IP66	35 mm ²	Cable junction boxes (E30) WKE 200 - 400 SB	98-99
	IP67	16 mm ²	Cable junction boxes (E30 - E90) WKE 54	100-101
	IP65	70 mm ²	Small distributors (F90 fireproof) WKE AK 14-70	102-107
	IP67	16 mm ²	Cable junction boxes (E30 - E90) WKE Rapid-Box	108-117

Intrinsic fire resistance

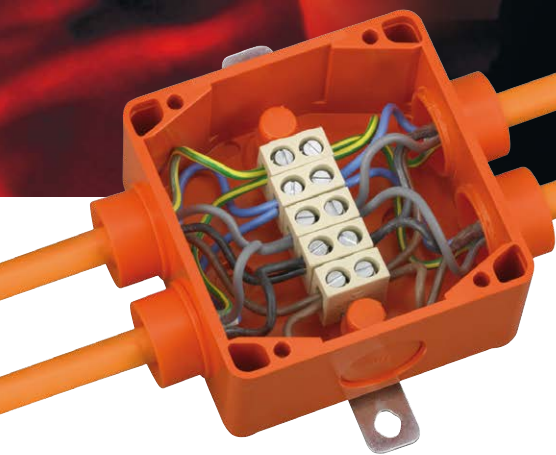

- The right solution for every crosssection and application
- Extensive range of accessories such as rawplugs and attachment bushes for all junction boxes
- External mounting brackets for quick installation
- State-tested by the MPA NRW
- Completely pre-assembled
- Upgradable to IP65
- Ideal for building installations

IP65
IP54

E30-
E90

FE180

F400

6-16²

IK05



450V
AC/DC



Junction boxes WKE 2 - 5 Duo / WKE 1 - 5

WKE 2 - Duo 3 x 6²

100 x 100 x 50 mm

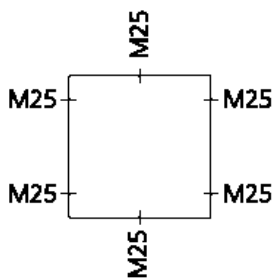

Description

Order no.

Cable junction and connection box with IP54 / IP65 certified acc. EN 60670, with electrical functional integrity E30 – E90 acc. to DIN 4102 Part 12, with insulation integrity FE180 acc. IEC 60331-11 as well as functional class F400 acc. EN 12101, halogen-free enclosure made from special duroplastic, terminals made from high temperature-proof special ceramics, rapid mounting thanks to external fixing brackets and wall + ceiling fastening parts kit D6

IP65
IP54

E30-
E90

FE180

F400

6²



450V
AC/DC



WKE 2 - Duo 3 x 6²

861 400 01

Connection box 3-pole 0.5 - 6 mm²,

Junction box 3-pole 0.5 - 6 mm²,

Number of conductors per pole:

16 x 0,5² / 8 x 0,75² / 12 x 1² / 12 x 1,5² / 4 x 2,5² / 4 x 4² / 4 x 6²

Accessories supplied:

Drilling template, D6 wall + ceiling attachment set,

4 IP54 attachment bushes M25,

seal range 9 - 18.5 mm,

1 IP54 sealing plug M25, seal range 9 - 18.5 mm

WKE 3 - Duo 3 x 6² / 2 x 6²

115 x 115 x 66 mm

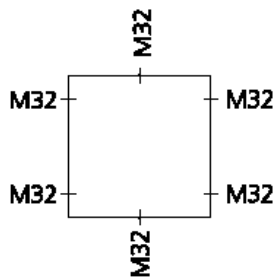
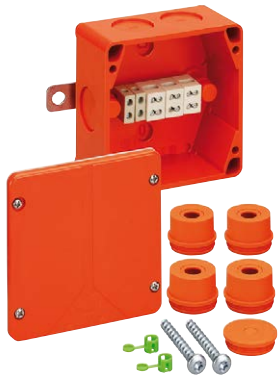

Cable junction and connection box with IP54 / IP65 certified acc. EN 60670, with electrical functional integrity E30 – E90 acc. to DIN 4102 Part 12, with insulation integrity FE180 acc. IEC 60331-11 as well as functional class F400 acc. EN 12101, halogen-free enclosure made from special duroplastic, terminals made from high temperature-proof special ceramics, rapid mounting thanks to external fixing brackets and wall + ceiling fastening parts kit D6

IP65
IP54

E30-
E90

FE180

F400

10²



450V
AC/DC



WKE 3 - Duo 3 x 6² / 2 x 6²

861 710 01

Connection box 5-pole 0.5 - 6 mm², Junction box 3-pole 0.5 - 6 mm²,

Number of conductors per pole:

16 x 0,5² / 8 x 0,75² / 12 x 1² / 12 x 1,5² / 4 x 2,5² / 4 x 4² / 4 x 6²,
in 2-pole continuity 8 x 0,5² / 4 x 0,75² / 6 x 1² / 6 x 1,5² / 2 x 2,5²
/ 2 x 4 / 2 x 6²

Accessories supplied:

Drilling template, D6 wall + ceiling attachment set,

4 IP54 attachment bushes M32,

seal range 13 - 23 mm, 1 IP54 sealing plug M32,

seal range 13 - 23 mm

WKE 4 - Duo 5 x 6²

165 x 165 x 76 mm

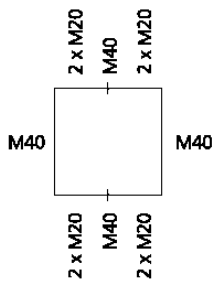
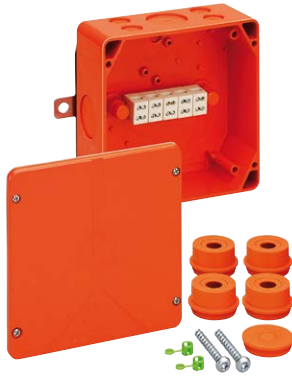

Description

Order no.

Cable junction and connection box with IP54 / IP65 certified acc. EN 60670, with electrical functional integrity E30 – E90 acc. to DIN 4102 Part 12, with insulation integrity FE180 acc. IEC 60331-11 as well as functional class F400 acc. EN 12101, halogen-free enclosure made from special duroplastic, terminals made from high temperature-proof special ceramics, rapid mounting thanks to external fixing brackets and wall + ceiling fastening parts kit D6

IP65
IP54

E30-
E90

FE180

F400

16²



450V
AC/DC



WKE 4 - Duo 5 x 6²

Connection box 5-pole 0.5 - 6 mm², Junction box 5-pole 0.5 - 6 mm²,
Number of conductors per pole:

16 x 0,5² / 8 x 0,75² / 12 x 1² / 12 x 1,5² / 4 x 2,5² / 4 x 4² / 4 x 6²

Accessories supplied:

Drilling template, D6 wall + ceiling attachment set,
4 IP54 attachment bushes M40,
seal range 17 - 30 mm, 1 IP54 sealing plug M40,
seal range 17 - 30 mm

861 410 01

WKE 4 - Duo 3 x 10²

165 x 165 x 76 mm

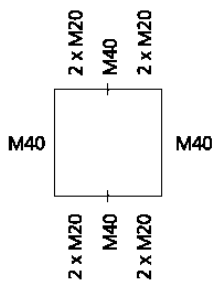

Cable junction and connection box with IP54 / IP65 certified acc. EN 60670, with electrical functional integrity E30 – E90 acc. to DIN 4102 Part 12, with insulation integrity FE180 acc. IEC 60331-11 as well as functional class F400 acc. EN 12101, halogen-free enclosure made from special duroplastic, terminals made from high temperature-proof special ceramics, rapid mounting thanks to external fixing brackets and wall + ceiling fastening parts kit D6

IP65
IP54

E30-
E90

FE180

F400

16²



450V
AC/DC



WKE 4 - Duo 3 x 10²

Connection box 3-pole 1 - 10 mm², Junction box 3-pole 1 - 10 mm²,
Number of conductors per pole:

20 x 1² / 16 x 1,5² / 12 x 2,5² / 8 x 4² / 4 x 6² / 4 x 10²

Accessories supplied:

Drilling template, D6 wall + ceiling attachment set,
4 IP54 attachment bushes M40,
seal range 17 - 30 mm, 1 IP54 sealing plug M40,
seal range 17 - 30 mm

861 500 01

WKE 4 - Duo 3 x 16²

165 x 165 x 76 mm

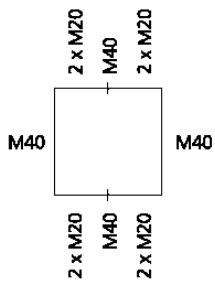

Description

Order no.

Cable junction and connection box with IP54 / IP65 certified acc. EN 60670, with electrical functional integrity E30 – E90 acc. to DIN 4102 Part 12, with insulation integrity FE180 acc. IEC 60331-11 as well as functional class F400 acc. EN 12101, halogen-free enclosure made from special duroplastic, terminals made from high temperature-proof special ceramics, rapid mounting thanks to external fixing brackets and wall + ceiling fastening parts kit D6

IP65
IP54

E30-
E90

FE180

F400

16²



450V
AC/DC



WKE 4 - Duo 3 x 16²

861 600 01

Connection box 3-pole 1.5 - 16 mm², Junction box 3-pole 1.5 - 16 mm²,
Number of conductors per pole:
20 x 1.5² / 16 x 2.5² / 12 x 4.0² / 8 x 6² / 4 x 10² / 4 x 16²

Accessories supplied:

Drilling template, D6 wall + ceiling attachment set,
4 IP54 attachment bushes M40, seal range 17 - 30 mm,
1 IP54 sealing plug M40, seal range 17 - 30 mm

WKE 5 - Duo 7 x 6²

171 x 256 x 106 mm

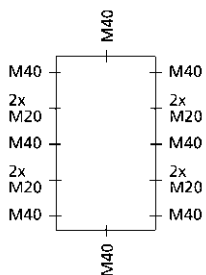

Cable junction and connection box with IP54 / IP65 certified acc. EN 60670, with electrical functional integrity E30 – E90 acc. to DIN 4102 Part 12, with insulation integrity FE180 acc. IEC 60331-11 as well as functional class F400 acc. EN 12101, halogen-free enclosure made from special duroplastic, terminals made from high temperature-proof special ceramics, rapid mounting thanks to external fixing brackets and wall + ceiling fastening parts kit D6

IP65
IP54

E30-
E90

FE180

F400

6²



450V
AC/DC



WKE 5 - Duo 7 x 6²

861 420 01

Connection box 7-pole 0.5 - 6 mm², Junction box 7-pole 0.5 - 6 mm²,
Number of conductors per pole:
16 x 0,5² / 8 x 0,75² / 12 x 1² / 12 x 1,5² / 4 x 2,5² / 4 x 4² / 4 x 6²

Accessories supplied:

Drilling template, D6 wall + ceiling attachment set,
6 IP54 attachment bushes M20, seal range 8 - 13 mm,
2 IP54 double end connectors M40, seal range 17 - 30 mm,
2 IP54 attachment bushes M40, seal range 17 - 30 mm,
1 IP54 sealing plug M20, seal range 8 - 13.5 mm,
1 IP54 sealing plug M40, seal range 17 - 30 mm

WKE 5 - Duo 5 x 10²

171 x 256 x 106 mm

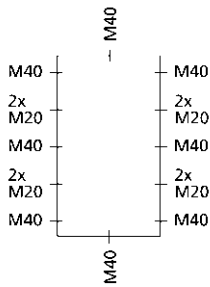

Description

Order no.

Cable junction and connection box with IP54 / IP65 certified acc. EN 60670, with electrical functional integrity E30 – E90 acc. to DIN 4102 Part 12, with insulation integrity FE180 acc. IEC 60331-11 as well as functional class F400 acc. EN 12101, halogen-free enclosure made from special duroplastic, terminals made from high temperature-proof special ceramics, rapid mounting thanks to external fixing brackets and wall + ceiling fastening parts kit D6



WKE 5 - Duo 5 x 10²

Connection box 5-pole 1 - 10 mm², Junction box 5-pole 1 - 10 mm²,
Number of conductors per pole:
20 x 1² / 16 x 1,5² / 12 x 2,5² / 8 x 4² / 4 x 6² / 4 x 10²

Accessories supplied:

Drilling template, D6 wall + ceiling attachment set,
6 IP54 attachment bushes M20, seal range 8 - 13 mm,
2 IP54 double end connectors M40, seal range 17 - 30 mm,
2 IP54 attachment bushes M40, seal range 17 - 30 mm,
1 IP54 sealing plug M20, seal range 8 - 13.5 mm,
1 IP54 sealing plug M40, seal range 17 - 30 mm

861 510 01

WKE 5 - Duo 5 x 16²

171 x 256 x 106 mm

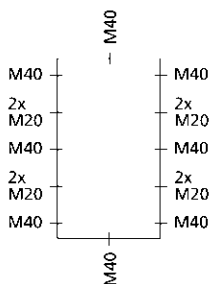

Cable junction and connection box with IP54 / IP65 certified acc. EN 60670, with electrical functional integrity E30 – E90 acc. to DIN 4102 Part 12, with insulation integrity FE180 acc. IEC 60331-11 as well as functional class F400 acc. EN 12101, halogen-free enclosure made from special duroplastic, terminals made from high temperature-proof special ceramics, rapid mounting thanks to external fixing brackets and wall + ceiling fastening parts kit D6



WKE 5 - Duo 5 x 16²

Connection box 5-pole 1.5 - 16 mm², Junction box 5-pole 1.5 - 16 mm²,
Number of conductors per pole:
20 x 1.5² / 16 x 2.5² / 12 x 4.0² / 8 x 6² / 4 x 10² / 4 x 16²

Accessories supplied:

Drilling template, D6 wall + ceiling attachment set,
6 IP54 attachment bushes M20, seal range 8 - 13 mm,
2 IP54 double end connectors M40, seal range 17 - 30 mm,
2 IP54 attachment bushes M40, seal range 17 - 30 mm,
1 IP54 sealing plug M20, seal range 8 - 13.5 mm,
1 IP54 sealing plug M40, seal range 17 - 30 mm

861 610 01

WKE 1 - 5 x 2,5²
100 x 100 x 50 mm

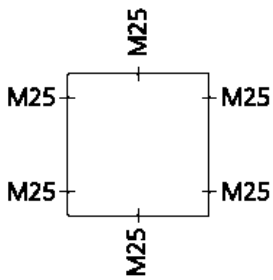

Description

Order no.

Junction box with IP54 / IP65 certified as per EN 60670, with electrical functional integrity E30 – E90 acc. to DIN 4102 Part 12, halogen-free enclosure made from special duroplastic, terminals made from high temperature-proof special ceramics



WKE 1 - 5 x 2,5²

Junction box 3 pole 0.5 - 2.5 mm², Branch box 3 pole 0.5 - 1.5 mm²,
Number of conductors per pole:
8 x 0,5² / 4 x 0,75² / 6 x 1² / 6 x 1,5² / 2 x 2,5²

Accessories supplied:

4 IP54 attachment bushes M25, seal range 9 - 18.5 mm,
1 IP54 sealing plug M25, seal range 9 - 18.5 mm

860 103 01

WKE 2 - 5 x 6²
100 x 100 x 50 mm

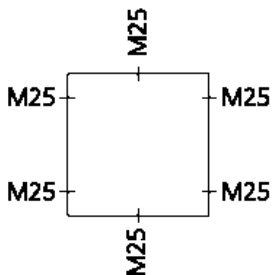
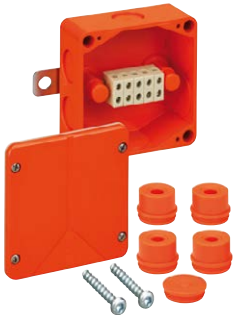

Junction box with IP54 / IP65 certified as per EN 60670, with electrical functional integrity E30 – E90 acc. to DIN 4102 Part 12, with insulation integrity FE180 acc. IEC 60331-11 as well as functional class F400 acc. EN 12101, halogen-free enclosure made from special duroplastic, terminals made from high temperature-proof special ceramics, rapid mounting thanks to external fixing brackets and wall + ceiling fastening parts kit D6



WKE 2 - 5 x 6²

Connection box 5-pole 0.5 - 6 mm², Junction box 5-pole 0.5 - 1.5 mm²,
Number of conductors per pole:
8 x 0.5² / 4 x 0.75² / 6 x 1² / 6 x 1.5² / 2 x 2.5² / 2 x 4² / 2 x 6²

Accessories supplied:

Drilling template, D6 wall + ceiling attachment set,
4 IP54 attachment bushes M25, seal range 9 - 18.5 mm,
1 IP54 sealing plug M25, seal range 9 - 18.5 mm

860 502 01

WKE 2 - 3 x 10²

100 x 100 x 50 mm

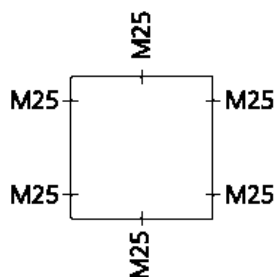

Description

Order no.

Junction box with IP54 / IP65 certified as per EN 60670, with electrical functional integrity E30 – E90 acc. to DIN 4102 Part 12, with insulation integrity FE180 acc. IEC 60331-11 as well as functional class F400 acc. EN 12101, halogen-free enclosure made from special duroplastic, terminals made from high temperature-proof special ceramics, rapid mounting thanks to external fixing brackets and wall + ceiling fastening parts kit D6

IP65
IP54

E30-
E90

FE180

F400

10²



450V
AC/DC



WKE 2 - 3 x 10²

Connection box 3-pole 1 - 10 mm², Junction box 3-pole 1 - 4 mm²,
Number of conductors per pole:
10 x 1² / 8 x 1.5² / 6 x 2.5² / 4 x 4² / 2 x 6² / 2 x 10²

Accessories supplied:

Drilling template, D6 wall + ceiling attachment set,
4 IP54 attachment bushes M25, seal range 9 - 18.5 mm,
1 IP54 sealing plug M25, seal range 9 - 18.5 mm

860 512 01

WKE 3 - 5 x 10²

115 x 115 x 66 mm

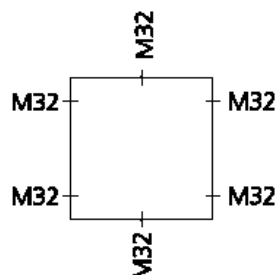

Junction box with IP54 / IP65 certified as per EN 60670, with electrical functional integrity E30 – E90 acc. to DIN 4102 Part 12, with insulation integrity FE180 acc. IEC 60331-11 as well as functional class F400 acc. EN 12101, halogen-free enclosure made from special duroplastic, terminals made from high temperature-proof special ceramics, rapid mounting thanks to external fixing brackets and wall + ceiling fastening parts kit D6

IP65
IP54

E30-
E90

FE180

F400

10²



450V
AC/DC



WKE 3 - 5 x 10²

Connection box 5-pole 1 - 10 mm², Junction box 5-pole 1 - 4 mm²,
Number of conductors per pole:
10 x 1² / 8 x 1.5² / 6 x 2.5² / 4 x 4² / 2 x 6² / 2 x 10²

Accessories supplied:

Drilling template, D6 wall + ceiling attachment set,
4 IP54 attachment bushes M32, seal range 13 - 23 mm,
1 IP54 sealing plug M32, seal range 13 - 23 mm

860 503 01

WKE 4 - 5 x 16²

165 x 165 x 76 mm

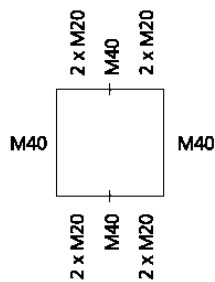
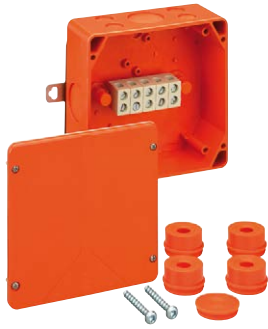

Description

Order no.

Junction box with IP54 / IP65 certified as per EN 60670, with electrical functional integrity E30 – E90 acc. to DIN 4102 Part 12, with insulation integrity FE180 acc. IEC 60331-11 as well as functional class F400 acc. EN 12101, halogen-free enclosure made from special duroplastic, terminals made from high temperature-proof special ceramics, rapid mounting thanks to external fixing brackets and wall + ceiling fastening parts kit D6

IP65
IP54

E30-
E90

FE180

F400

16²



450V
AC/DC



WKE 4 - 5 x 16²

Connection box 5-pole 1.5 - 16 mm², Junction box 5-pole 1.5 - 6 mm²,
Number of conductors per pole:
10 x 1.5² / 8 x 2.5² / 4 x 4² / 4 x 6² / 2 x 10² / 2 x 16²

Accessories supplied:

Drilling template, D6 wall + ceiling attachment set,
4 IP54 attachment bushes M40, seal range 17 - 30 mm,
1 IP54 sealing plug M40, seal range 17 - 30 mm

860 504 01

WKE 4 - 8 x 6²

165 x 165 x 76 mm

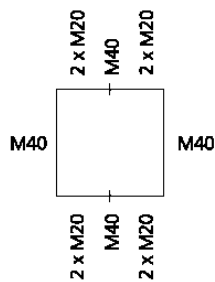

Junction box with IP54 / IP65 certified as per EN 60670, with electrical functional integrity E30 – E90 acc. to DIN 4102 Part 12, with insulation integrity FE180 acc. IEC 60331-11 as well as functional class F400 acc. EN 12101, halogen-free enclosure made from special duroplastic, terminals made from high temperature-proof special ceramics, rapid mounting thanks to external fixing brackets and wall + ceiling fastening parts kit D6

IP65
IP54

E30-
E90

FE180

F400

6²



450V
AC/DC



WKE 4 - 8 x 6²

Connection box 8-pole 0.5 - 6 mm², Junction box 8-pole 0.5 - 1.5 mm²,
Number of conductors per pole:
8 x 0.5² / 4 x 0.75² / 6 x 1² / 6 x 1.5² / 2 x 2.5² / 2 x 4² / 2 x 6²

Accessories supplied:

Drilling template, D6 wall + ceiling attachment set,
2 IP54 attachment bushes M40, seal range 17 - 30 mm,
2 IP54 double end connectors M40, seal range 8 - 13 mm,
1 IP54 sealing plug M20, seal range 8 - 13.5 mm,
1 IP54 sealing plug M40, seal range 17 - 30 mm

860 514 01

WKE 5 - 15 x 6²

171 x 256 x 106 mm

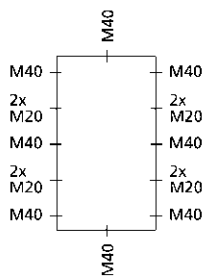

Description

Order no.

Junction box with IP54 / IP65 certified as per EN 60670, with electrical functional integrity E30 – E90 acc. to DIN 4102 Part 12, with insulation integrity FE180 acc. IEC 60331-11 as well as functional class F400 acc. EN 12101, halogen-free enclosure made from special duroplastic, terminals made from high temperature-proof special ceramics, rapid mounting thanks to external fixing brackets and wall + ceiling fastening parts kit D6

IP65
IP54

E30-
E90

FE180

F400

6²



450V
AC/DC



WKE 5 - 15 x 6²

Connection box 15-pole 0.5 - 6 mm², Junction box 15-pole 0.5 - 1.5 mm²,
Number of conductors per pole:
8 x 0.5² / 4 x 0.75² / 6 x 1² / 6 x 1.5² / 2 x 2.5² / 2 x 4² / 2 x 6²

860 505 01

Accessories supplied:

Drilling template, D6 wall + ceiling attachment set,
6 IP54 attachment bushes M20, seal range 8 - 13 mm,
2 IP54 attachment bushes M40, seal range 17 - 30 mm,
2 IP54 double end connectors M40, seal range 17 - 30 mm,
1 IP54 sealing plug M20, seal range 8 - 13.5 mm,
1 IP54 sealing plug M40, seal range 17 - 30 mm

WKE 5 - 20 x 6²

171 x 256 x 106 mm

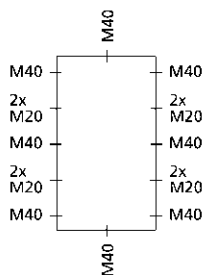
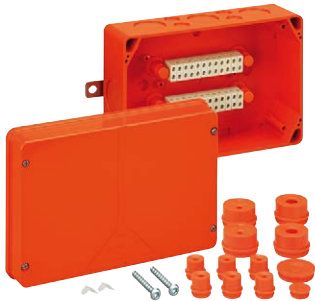

Junction box with IP54 / IP65 certified as per EN 60670, with electrical functional integrity E30 – E90 acc. to DIN 4102 Part 12, with insulation integrity FE180 acc. IEC 60331-11 as well as functional class F400 acc. EN 12101, halogen-free enclosure made from special duroplastic, terminals made from high temperature-proof special ceramics, rapid mounting thanks to external fixing brackets and wall + ceiling fastening parts kit D6

IP65
IP54

E30-
E90

FE180

F400

6²



450V
AC/DC



WKE 5 - 20 x 6²

Connection box 2 x 10-pole 0.5 - 6 mm²,
Junction box 2 x 10-pole 0.5 - 1.5 mm², Number of conductors per pole:
8 x 0.5² / 4 x 0.75² / 6 x 1² / 6 x 1.5² / 2 x 2.5² / 2 x 4² / 2 x 6²

860 505 20

Accessories supplied:

Drilling template, D6 wall + ceiling attachment set,
6 IP54 attachment bushes M20, seal range 8 - 13 mm,
2 IP54 attachment bushes M40, seal range 17 - 30 mm,
2 IP54 double end connectors M40, seal range 17 - 30 mm,
1 IP54 sealing plug M20, seal range 8 - 13.5 mm,
1 IP54 sealing plug M40, seal range 17 - 30 mm

WKE 5 - 24 x 6²

171 x 256 x 106 mm

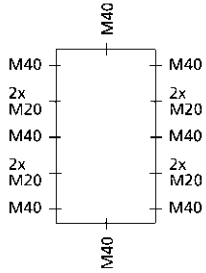

Description

Order no.

Junction box with IP54 / IP65 certified as per EN 60670, with electrical functional integrity E30 – E90 acc. to DIN 4102 Part 12, with insulation integrity FE180 acc. IEC 60331-11 as well as functional class F400 acc. EN 12101, halogen-free enclosure made from special duroplastic, terminals made from high temperature-proof special ceramics, rapid mounting thanks to external fixing brackets and wall + ceiling fastening parts kit D6

IP65
IP54

E30-
E90

FE180

F400

6²



450V
AC/DC



WKE 5 - 24 x 6²

860 505 24

Connection box 2 x 12-pole 0.5 - 6 mm²,
Junction box 2 x 12-pole 0.5 - 1.5 mm², Number of conductors per pole:
8 x 0.5² / 4 x 0.75² / 6 x 1² / 6 x 1.5² / 2 x 2.5² / 2 x 4² / 2 x 6²

Accessories supplied:

Drilling template, D6 wall + ceiling attachment set,
6 IP54 attachment bushes M20, seal range 8 - 13 mm,
2 IP54 attachment bushes M40, seal range 17 - 30 mm,
2 IP54 double end connectors M40, seal range 17 - 30 mm,
1 IP54 sealing plug M20, seal range 8 - 13.5 mm,
1 IP54 sealing plug M40, seal range 17 - 30 mm

Sealing plugs



IP54

Blanking plug with closed sealing membrane, no lock nuts required, for wall thickness 1.5 - 4.0 mm

Sealing area/mm

VST M20-or	8 - 13.5	231 620 01
VST M25-or	9 - 16	231 625 01
VST M32-or	13 - 23	231 632 01
VST M40-or	17 - 30	231 640 01

Attachment bushes



IP54

Attachment bushes with open sealing membrane, for wall thickness 1.5 - 4.0 mm

Sealing area/mm

AST M20-or	8 - 13.5	230 620 01
AST M25-or	9 - 18.5	230 625 01
AST M32-or	13 - 23	230 632 01
AST M40-or	17 - 30	230 640 01

Cable gland



IP68

Cable gland for WKE 2-5, with strain relief, polyamide, M_ x 1.5 mm, with lock nut

Thread length/mm Sealing area/mm

KVR M20-MGM/or	9	7 - 14.0	227 620 01
KVR M25-MGM/or	11	9 - 16	227 625 01
KVR M32-MGM/or	11	11 - 21.0	227 632 01
KVR M40-MGM/or	11	16 - 28.0	227 640 01



1. MARK



2. DRILL (Ø 6 mm)



3. SCREW



4. FINISHED



Sand-lime bricks

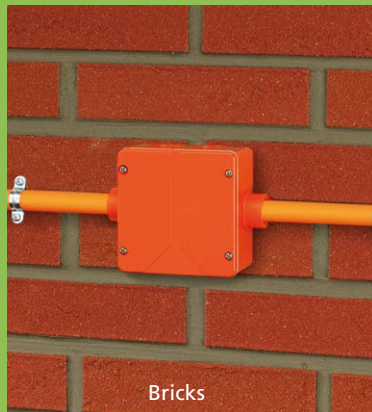

Bricks

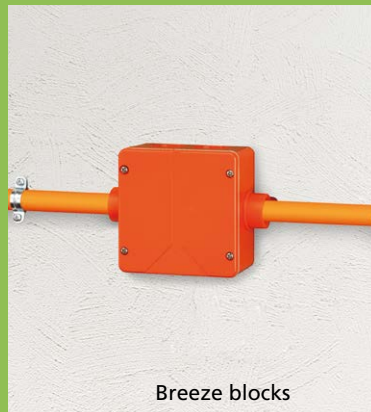

Breeze blocks





Concrete

The D6 attachment set is approved for installation in cracked and uncracked concrete as well as many other building materials, including: clinker bricks, natural stone (such as marble), sand-lime bricks, hollow concrete blocks, solid bricks.

**WKE 2-5 installation...
time savings of at
least 50%.**



Cable gland clamping areas

		Nm
M 12 x 1,5	4 - 6,5	2
M 16 x 1,5	4 - 10	2,5
M 20 x 1,5	6 - 12	4
M 20 x 1,5	7 - 14	4
M 25 x 1,5	9 - 16	6
M 32 x 1,5	11 - 21	7
M 40 x 1,5	16 - 28	7,5



= Cable gland



= Clamping area



= Rated torque



= Cable cross-section

Number of conductors that can be clamped for each pole

	Terminal 6 ² Rated torque 0,8 Nm			Terminal 10 ² Rated torque 1,2 Nm			Terminal 16 ² Rated torque 2,0 Nm		
									
0,5 ²	16	8	4						
0,75 ²	8	4	2						
1,0 ²	12	6	3	20	10	5			
1,5 ²	12	6	3	16	8	4	20	10	5
2,5 ²	4	2	1	12	6	3	16	8	4
4 ²	4	2	1	8	4	2	12	6	3
6 ²	4	2	1	4	2	1	8	4	2
10 ²				4	2	1	4	2	1
16 ²							4	2	1

 = Single terminal, 2 clamping points  = Clamping point

 = Double terminal, 2 clamping points

**E30-
E90**

Maintaining electrical function
according to DIN 4102 Part 12

- E stands for electrical function
- 30-90 represents the duration in minutes

FE180

Insulation integrity
based on VDE 0472-814 IEC 60331

- FE stands for flame or fire effects
- 180 for the time in minutes

F400

Functional life
according to EN 12101-3

- Functions for 120 minutes at 400°C



- Fuse-protected branch with maintained function
- Clamping area up to 35²
- Especially sturdy
- Ideal for time and material savings in building installation planning
- State-tested by the MPA NRW

▲ **External mounting brackets**
for quick installation

- Current test certificate available online at www.spelsberg.com
- Extensive range of accessories such as rawlplugs and cable glands for all junction boxes
- The right solution for every cross-section and application

IP66

E30

FE180

F400

35²

IK08



450V
AC/DC



Junction boxes WKE 200 - 400 RK

WKE 202 RK

115 x 115 x 93 mm

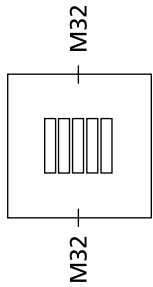

Description

Order no.

Junction box with IP66 certified as per EN 60670, with electrical functional integrity E30 acc. to DIN 4102 Part 12, with insulation integrity FE180 acc. IEC 60331-11 as well as functional class F400 acc. EN 12101, enclosure and terminal strips made from halogen-free special duroplastic



WKE 202 RK

Junction box 5-pole, termination capability per pole 2 x 0.5 - 6 mm²

862 202 01

Accessories supplied:

Wall plug set ø 6 mm, 2 cable glands M32, seal range 17 - 26 mm

Intrinsic fire resistance

WKE 203 RK

115 x 115 x 93 mm

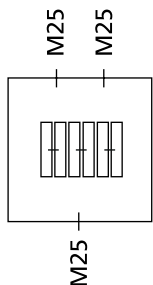
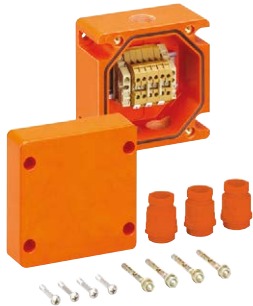

Cable junction and connection box with IP66 certified acc. EN 60670, with electrical functional integrity E30 acc. to DIN 4102 Part 12, with insulation integrity FE180 acc. IEC 60331-11 as well as functional class F400 acc. EN 12101, enclosure and terminal strips made from halogen-free special duroplastic



WKE 203 RK

Junction box 3-pole, termination capability for each pole 4 x 0.5 - 4 mm²

862 203 01

Accessories supplied:

Wall plug set ø 6 mm, 3 cable glands M25, seal range 6 - 15 mm

WKE 204 RK

115 x 115 x 93 mm

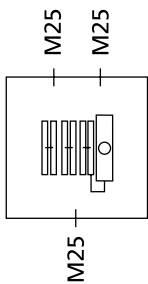
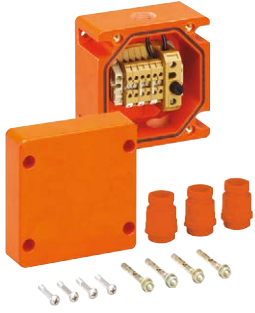

Description

Order no.

Cable junction and connection box with IP66 certified acc. EN 60670, with electrical functional integrity E30 acc. to DIN 4102 Part 12, with insulation integrity FE180 acc. IEC 60331-11 as well as functional class F400 acc. EN 12101, enclosure and terminal strips made from halogen-free special duroplastic

IP66

E30

FE180

F400

4²



450V
AC/DC



WKE 204 RK

Junction box with fused E30 branch, 3-pole in transition area, termination capability for each pole 4 x 0.5 - 4 mm², 3-pole in fused E30 branch, termination capability for each pole 1 x 0.5 - 4 mm², Fuse (20 x 5 mm) max. 6.3A,

Accessories supplied:
Wall plug set ø 6 mm, 3 cable glands M25,
seal range 6 - 15 mm

862 204 01

WKE 302 RK

160 x 160 x 110 mm

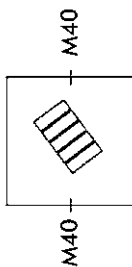

Junction box with IP66 certified as per EN 60670, with electrical functional integrity E30 acc. to DIN 4102 Part 12, with insulation integrity FE180 acc. IEC 60331-11 as well as functional class F400 acc. EN 12101, enclosure and terminal strips made from halogen-free special duroplastic

IP66

E30

FE180

F400

16²



450V
AC/DC



WKE 302 RK

Junction box 5-pole, termination capability for each pole 4 x 4 - 16 mm²

Accessories supplied:
Wall plug set ø 6 mm, 2 cable glands M40,
seal range 17 - 27 mm

862 302 01

WKE 303 RK

160 x 160 x 110 mm

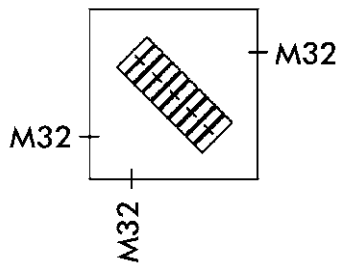

Description

Order no.

Junction box with IP66 certified as per EN 60670, with electrical functional integrity E30 acc. to DIN 4102 Part 12, with insulation integrity FE180 acc. IEC 60331-11 as well as functional class F400 acc. EN 12101, enclosure and terminal strips made from halogen-free special duroplastic

IP66

E30

FE180

F400

10°



450V
AC/DC



WKE 303 RK

Junction box 5-pole, termination capability for each pole 4 x 2.5 - 10 mm²

862 303 01

Accessories supplied:

Wall plug set ø 6 mm, 3 cable glands M32,
seal range 17 - 26 mm

WKE 304 RK

160 x 160 x 110 mm

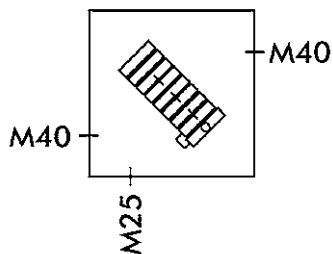

Cable junction and connection box with IP66 certified acc. EN 60670, with electrical functional integrity E30 acc. to DIN 4102 Part 12, with insulation integrity FE180 acc. IEC 60331-11 as well as functional class F400 acc. EN 12101, enclosure and terminal strips made from halogen-free special duroplastic

IP66

E30

FE180

F400

10°



450V
AC/DC



WKE 304 RK

Junction box with fused E30 branch, 5-pole in transition area, termination capability for each pole 2 x 2.5 - 10 mm², 3-pole in fused E30 branch, termination capability for each pole 1 x 1.5 - 10 mm², Fuse (20 x to 5 mm) max. 6.3A

862 304 01

Accessories supplied:

Wall plug set ø 6 mm, 2 cable glands M40,
seal range 17 - 27 mm, 1 cable gland M25, seal range 6 - 15 mm

WKE 402 RK
200 x 200 x 110 mm

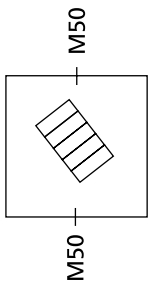

Description

Order no.

Cable junction and connection box with IP66 certified acc. EN 60670, with electrical functional integrity E30 acc. to DIN 4102 Part 12, with insulation integrity FE180 acc. IEC 60331-11 as well as functional class F400 acc. EN 12101, enclosure and terminal strips made from halogen-free special duroplastic



WKE 402 RK
Junction box 5-pole, termination capability for each pole 2 x 2.5 - 35 mm²

862 402 01

Accessories supplied:
Wall plug set ø 6 mm, 2 cable glands M50,
seal range 23 - 34 mm

WKE 403 RK
200 x 200 x 110 mm

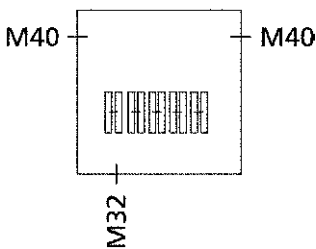

Junction box with IP66 certified as per EN 60670, with electrical functional integrity E30 acc. to DIN 4102 Part 12, with insulation integrity FE180 acc. IEC 60331-11 as well as functional class F400 acc. EN 12101, enclosure and terminal strips made from halogen-free special duroplastic



WKE 403 RK
Junction box 5-pole, termination capability for each pole 4 x 4 - 16 mm²

862 403 01

Accessories supplied:
Wall plug set ø 6 mm, 2 cable glands M40,
seal range 17 - 27 mm, 1 cable gland M32, seal range 17 - 26 mm

WKE 404 RK

200 x 200 x 110 mm

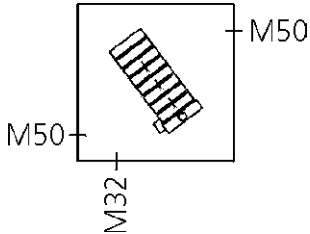
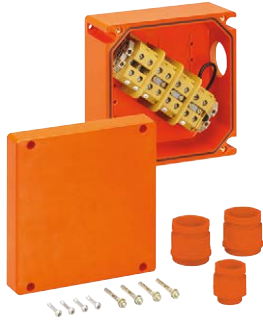

Description

Order no.

Cable junction and connection box with IP66 certified acc. EN 60670, with electrical functional integrity E30 acc. to DIN 4102 Part 12, with insulation integrity FE180 acc. IEC 60331-11 as well as functional class F400 acc. EN 12101, enclosure and terminal strips made from halogen-free special duroplastic

IP66

E30

FE180

F400

35²



450V
AC/DC



WKE 404 RK

862 404 01

Junction box with fused E30 branch, 5-pole in transition area, termination capability for each pole 2 x 2.5 - 35 mm², 3-pole in fused E30 branch, termination capability for each pole 1 x 1.5 - 10 mm², Fuse (20 x to 5 mm) max. 6.3A

Accessories supplied:

Wall plug set ø 6 mm, 2 cable glands M50, seal range 23 - 34 mm, 1 cable gland M32, seal range 17 - 26 mm

WKE 405 LSA

200 x 200 x 110 mm

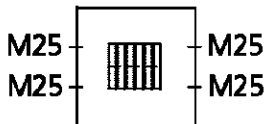
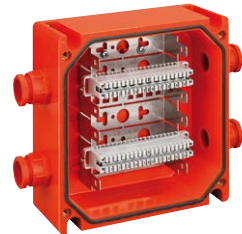

Tested system: WKE 405 - cable junction boxes with time-saving (solder, screw and stripping free) connection technology for cables with functional integrity according to DIN 4102 Part 12 - tested by the MPA Dresden

IP66

E30



LSA plus

WKE 405 LSA

862 405 01

Junction box equipped with two LSA-Plus connector blocks, respectively for 10 double wires (2 x 10 DA), the LSA-Plus contacts are suitable for a solid conductor with 0.4 to 0.8 mm diameter and an outside insulation diameter of 0.7 to 1.6 mm

Accessories supplied:

Wall plug set ø 6 mm, 4 cable glands M25, seal range 9 - 19 mm

External fixing lugs



External fastening kit V2A

WKE 200 ABL

860 400 01

External fastening kit V2A, for WKE 200 up to WKE 400, Material stainless steel V2A (1.4301), Set = 4 pcs.

KVS

890 040 01

Cable gland protection set, is needed for IK 09 when cable glands are used, for WKE 200 up to WKE 400, IK09, Material stainless steel V2A (1.4301), Set = 3 pcs.

WKE 200 Assembly of entries and terminals

Construction project: _____

Customer: _____

If required, please attach sketch for pre-wiring of terminal!

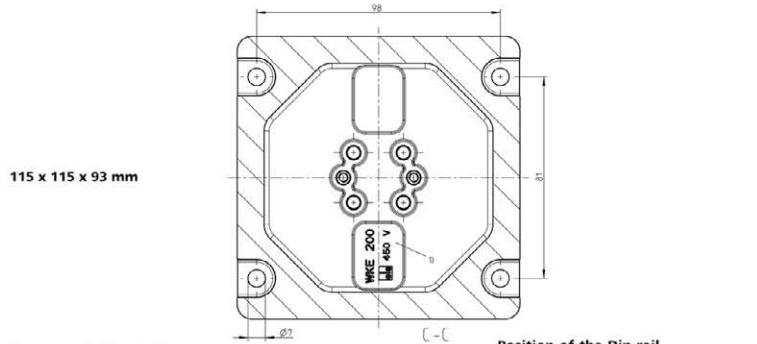

Please mark threaded holes accordingly
M20 / M25 / M32 / M40 / M50

Position of the Din rail
The rail can be fixed in 5 different positions horizontally and diagonally. Please mark accordingly!

Outer diameter of the cables: _____ mm
 Cross-section of the wire: _____ mm²
 Cross-section of the terminals: _____ mm²
 Cross connector: _____ pieces
 Qty of terminals: _____ pieces
 External fixing lugs: 2 pieces 4 pieces
 Dowel WKE V4A 4 pieces
 Required quantity: _____ pieces

Attention; cable glands and external fixing lugs are enclosed just like in standard parts.

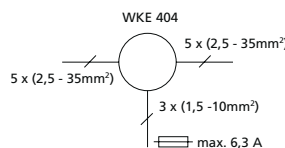
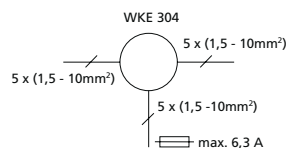
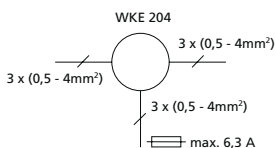
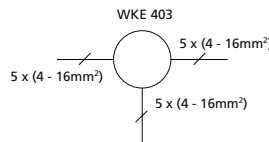
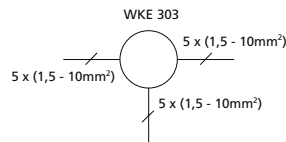
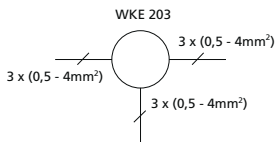
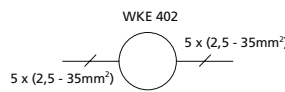
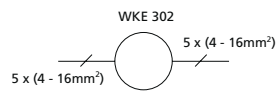
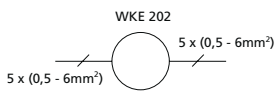

- 0.5² to 35²
- Protection rating IP66
- 6.3 A fuse
- Particularly robust quality
- High impact strength
- Maintained function to class E30 as per DIN 4102 Part 12
- Maintained function for the fused branch
- Halogen-free duroplastic housing
- Sealable
- Delivered as complete package including accessories
- MPA test certificate
- VDE approved
- Colour similar to RAL 2004
- Terminal blocks and fuse terminals made of duroplastic

Cabling scheme WKE 200 - 400 RK

Standard cabling

Cabling that saves time, money and materials

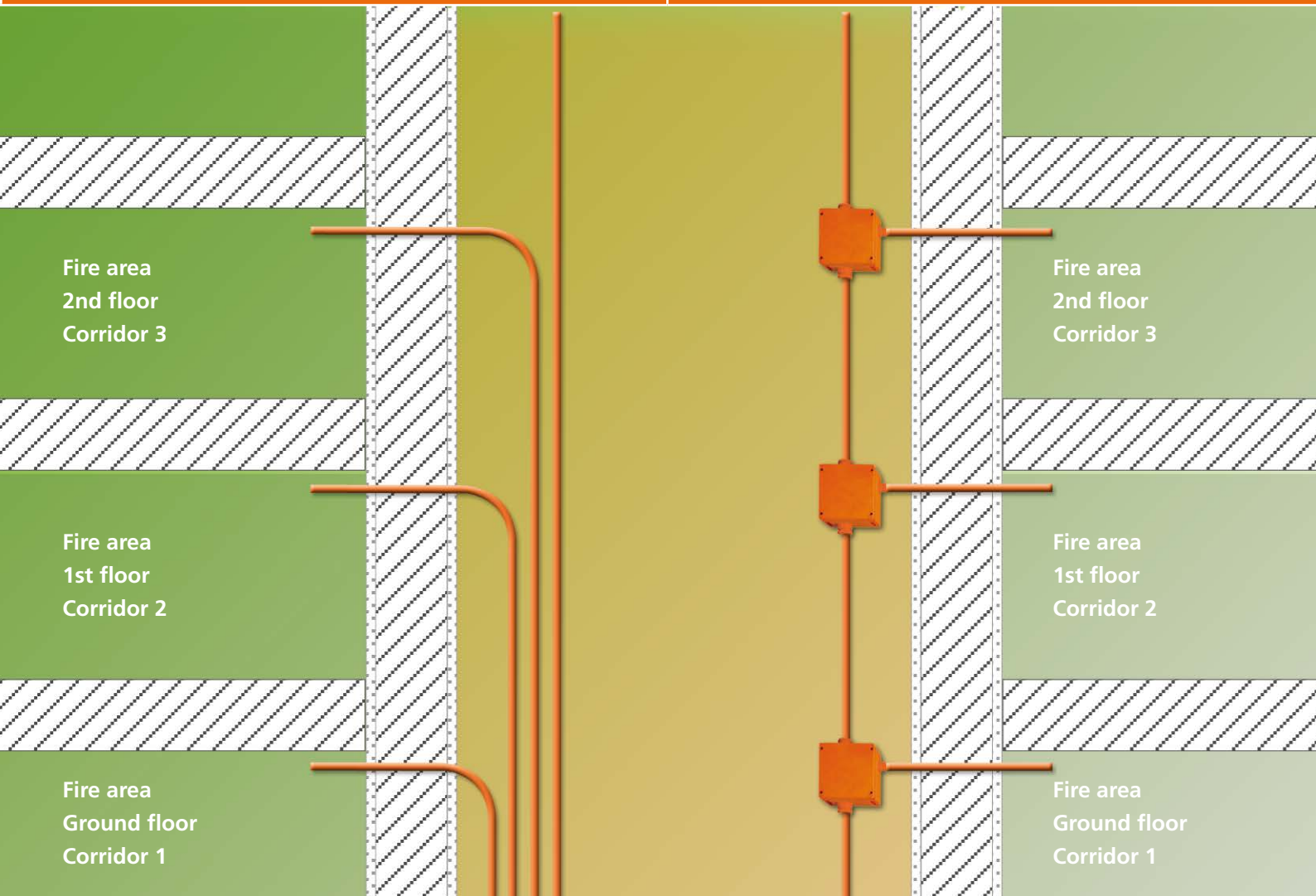

WKE terminal block

Terminal designation	Conductor cross-section (single-wire)		Conductor cross-section (multiwire)		Tightening torque	
	min.	max.	min.	max.	min.	max.
WKE SAK 2.5 / 35	0.5 mm ²	6 mm ²	0.5 mm ²	4 mm ²	0.4 Nm	0.6 Nm
WKE SAK 6 / 35	0.5 mm ²	10 mm ²	1.5 mm ²	6 mm ²	0.8 Nm	1.6 Nm
WKE SAK 10 / 35	1.5 mm ²	10 mm ²	1.5 mm ²	16 mm ²	2 Nm	2.4 Nm
WKE SAK 16 / 35	2.5 mm ²	16 mm ²	4 mm ²	16 mm ²	2 Nm	2.4 Nm
WKE SAK 35 / 35	2.5 mm ²	16 mm ²	4 mm ²	35 mm ²	4 Nm	5 Nm

Cable gland clamping areas

Icon	Clamping area	Rated torque (Nm)
M 20 x 1.5	6 - 13	4
M 25 x 1.5	6 - 15	6
M 25 x 1.5	9 - 19	6
M 32 x 1.5	17 - 26	7
M 40 x 1.5	17 - 27	7.5
M 50 x 1.5	23 - 34	7.5

- = Cable gland
- = Clamping area
- = Rated torque

E30

Intrinsic fire resistance.

according to DIN 4102 Part 12

- E stands for electrical function
- 30 represents the duration in minutes

FE180

Insulation integrity

based on VDE 0472-814, IEC 60331

- FE stands for flame or fire effects
- 180 for the time in minutes

F400

Functional life

according to EN 12101-3

- Functions for 120 minutes at 400°C

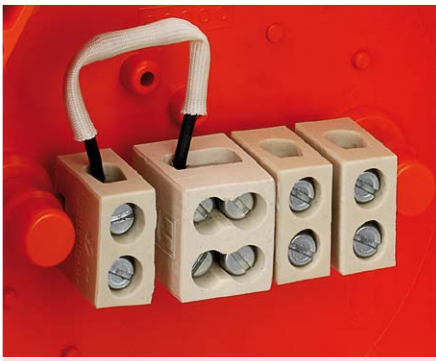

■ Exchangeable fuses



■ Exchangeable fuses

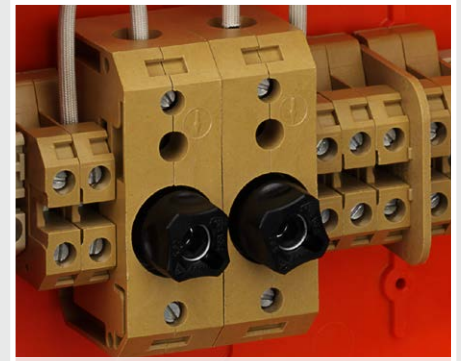

■ D02 fuse terminal block



WKE 2-5 SB



WKE 54



WKE 200-400 SB



Products should always also be tested and certified under special operating conditions, to ensure electrical functional integrity. Unfortunately, this is generally disregarded by many users and manufacturers, and products and systems are offered and installed that have only been electrically tested under standard conditions. It has therefore not been verified that these function under the special operating conditions (fire).

Spelsberg is the first manufacturer to have its cable junction and connection boxes tested and certified by VDE under fire conditions. The new junction boxes with fused branch maintain the through-feed function for up to 90 minutes.

Two different variants of the fused branch are available in the WKE range:

WKE 2-5 SB and WKE 54:

The through-feed functions in case of fire and the fused branch is switched off by a fuse element in case of a fault.

WKE 200-400 SB:

The through-feed and the fused branch function in case of a fire.

Junction and connection boxes

WKE SB with fused junction



WKE 2 – 3/1 x 6² 1SB

100 x 100 x 50 mm

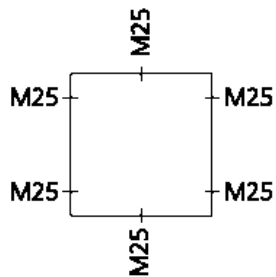

Description

Order no.

Cable junction and connection boxes with IP54/IP65 certified as per EN 61439-2, with intrinsic fire resistance E30 – E90 acc. To DIN 4102 Part 12 in the bore, halogen-free enclosure made from special duroplastic

IP65
IP54

E30-
E90

6²



450V
AC/DC



WKE 2 - 3/1 x 6² 1SB

Clamp 0.5 – 6² from high-temperature resistant special ceramic, Junction 2 A

863 721 01

Accessories supplied:

Drill template, Wall + ceiling attachment set D6,
4 IP54 attachment bushes M25, seal range 9 - 18.5 mm,
1 IP54 sealing plug M25, seal range 9 - 18.5 mm

WKE 4 - 4/3 x 6² 2SB

165 x 165 x 76 mm

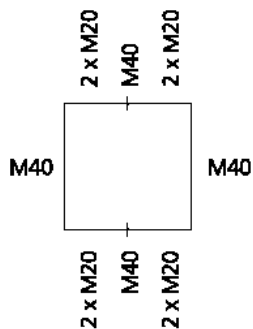
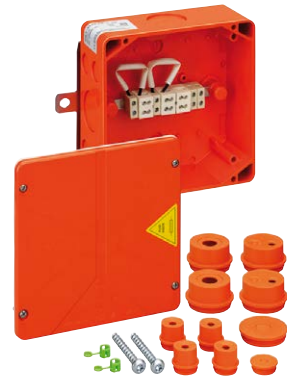

Cable junction and connection boxes with IP54/IP65 certified as per EN 61439-2, with intrinsic fire resistance E30 – E90 acc. To DIN 4102 Part 12 in the bore, halogen-free enclosure made from special duroplastic

IP65
IP54

E30-
E90

6²



450V
AC/DC



WKE 4 - 4/3 x 6² 2SB

Clamp 0.5 – 6² from high-temperature resistant special ceramic, junction 2 A

863 747 01

Accessories supplied:

4 IP54 attachment bushes M20
2 IP54 attachment bushes M40,
1 IP54 sealing plug M20,
1 IP54 sealing plug M40,
2 IP54 double end connectors M40

WKE 4 – 3/1 x 16² 1SB

165 x 165 x 76 mm

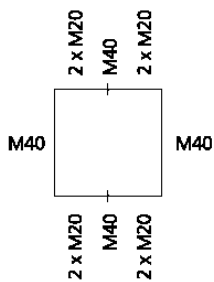

Description

Order no.

Cable junction and connection boxes with IP54/IP65 certified as per EN 61439-2, with intrinsic fire resistance E30 – E90 acc. To DIN 4102 Part 12 in the bore, halogen-free enclosure made from special duroplastic

IP65
IP54

E30-
E90

16²



450V
AC/DC



WKE 4 - 3/1 x 16² 1SB

Clamp 1.5 – 16² from high-temperature resistant special ceramic, Junction 2 A

863 921 01

Accessories supplied:

Drill template, Wall + ceiling attachment set D6,
2 IP54 attachment bushes M40, seal range 17 - 30 mm,
2 IP54 double end connectors M40, seal range 8 - 13.5 mm,
1 IP54 sealing plug M20, seal range 8 - 13.5 mm,
1 IP54 sealing plug M40, seal range 17 - 30 mm

WKE 5 – 4/3 x 16² 2SB

256 x 171 x 106 mm

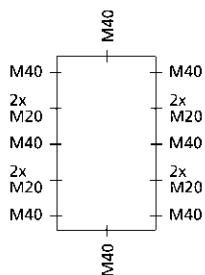
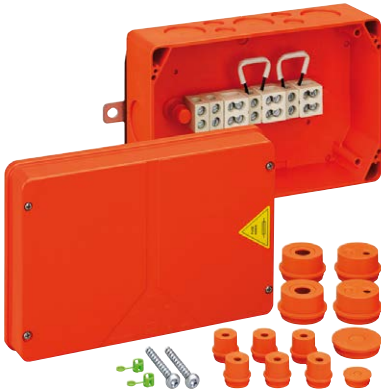

Cable junction and connection boxes with IP54/IP65 certified as per EN 61439-2, with intrinsic fire resistance E30 – E90 acc. To DIN 4102 Part 12 in the bore, halogen-free enclosure made from special duroplastic

IP65
IP54

E30-
E90

16²



450V
AC/DC



WKE 5 – 4/3 x 16² 2SB

Clamp 1.5 – 16² from high-temperature resistant special ceramic, junction 2 A

863 748 01

Accessories supplied:

Drill template, Wall + ceiling attachment set D6,
6 IP54 attachment bushes M20, seal range 8 - 13.5 mm,
2 IP54 attachment bushes M40, seal range 17 - 30 mm,
2 IP54 double end connectors M40, seal range 8 - 13.5 mm,
1 IP54 sealing plug M20, Sealing range 8 - 13.5 mm,
1 IP54 sealing plug M40, seal range 17 - 30 mm

Sealing plugs



IP54

Description

Order no.

Blanking plug with closed sealing membrane, no lock nuts required, for wall thickness 1.5 - 4.0 mm

	Sealing area/mm	
VST M20-or	8 - 13.5	231 620 01
VST M25-or	9 - 16	231 625 01
VST M32-or	13 - 23	231 632 01
VST M40-or	17 - 30	231 640 01

Attachment bushes



IP54

Attachment bushes with open sealing membrane, for wall thickness 1.5 - 4.0 mm

	Sealing area/mm	
AST M20-or	8 - 13.5	230 620 01
AST M25-or	9 - 18.5	230 625 01
AST M32-or	13 - 23	230 632 01
AST M40-or	17 - 30	230 640 01

Cable gland



IP68

Cable gland for WKE 2-5, with strain relief, polyamide, M_ x 1.5 mm, with lock nut

	Thread lenght/mm	Sealing area/mm	
KVR M20-MGM/or	9	7 - 14.0	227 620 01
KVR M25-MGM/or	11	9 - 16	227 625 01
KVR M32-MGM/or	11	11 - 21.0	227 632 01
KVR M40-MGM/or	11	16 - 28.0	227 640 01

WKE BS F2A spare fuses



Spare fuses for WKE 2-5 in the "SB" versions, wired device fuses F2A in the size 5x20 mm coated with a glass fibre sleeve

WKE BS F2A 10 pieces per packaging unit	863 001 01
--	------------

Intrinsic fire resistance

WKE 300 8 x 6² 2FS
160 x 160 x 110 mm

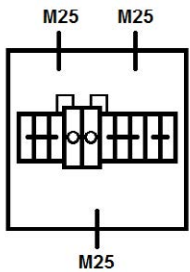

Description

Order no.

Cable junction and connection boxes with IP66 certified as per EN 61439-2, with electrical functional integrity E30 according to DIN 4102 Part 12 in the duct



WKE 300 8x 6² 2FS
Terminal blocks 0.5 – 6² and fuse holder (max. 6,3 A) made from halogen-free special thermoset

862 262 01

Accessories supplied:
8 terminal clamps 0.5 - 6 mm², 2 micro-fuse terminals,
1.5 - 10 mm², 3 M25 cable glands (9 -16mm)

WKE 400 7 x 10² 1D0
200 x 200 x 110 mm

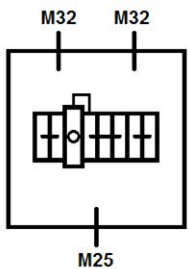

Cable junction and connection boxes with IP66 certified as per EN 61439-2, with electrical functional integrity E30 according to DIN 4102 Part 12 in the duct



WKE 400 7 x 10² 1D0
Terminal clamps 2.5 – 10² and fuse holder (max. 6 A) made from halogen-free special thermoset

862 355 01

Accessories supplied:
7 terminal blocks 2.5 - 10 mm²,
1 D0 fuse terminal, 1.5 - 10 mm²,
2 M32 cable glands (11 -21mm),
1 M25 cable glands (9 -16mm)

WKE 400 7 x 10² 2D0
200 x 200 x 110 mm

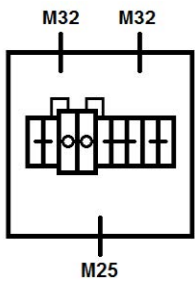

Description

Order no.

Cable junction and connection boxes with IP66 certified as per EN 61439-2, with electrical functional integrity E30 according to DIN 4102 Part 12 in the duct

IP66

E30

10²



450V
AC/DC



WKE 400 7 x 10² 2D0

Terminal clamps 2.5 – 10² and fuse holder (max. 6 A) made from halogen-free special thermostet

Accessories supplied:

7 terminal blocks 2.5 - 10 mm², 2 D0 fuse terminals, 1.5 - 10 mm²,
2 M32 cable glands (11 -21mm), 1 M25 cable glands (9 -16mm)

862 356 01

Intrinsic fire resistance

External fixing lugs



External fastening kit V2A

WKE 200 ABL

External fastening kit V2A, for WKE 200 up to WKE 400, Material stainless steel V2A (1.4301), Set = 4 pcs.

860 400 01

KVS

Cable gland protection set, is needed for IK 09 when cable glands are used, for WKE 200 up to WKE 400, IK09, Material stainless steel V2A (1.4301), Set = 3 pcs.

890 040 01



- Fuse-protected branch
- 16² double terminal
- Ideal for use in tunnels and industrial settings

E90 maintained function

- According to DIN 4102 Part 12
- Functioning electrical installation over 90 minutes
- Tested by MPA Dresden

IP67 protection rating

- According to DIN EN 60670
- No penetration by dust
- Protection against temporary immersion in water, IK07 degree of protection
- According to VDE 0470 part 100; EN 50102
- Protection against external mechanical stress

Pressure and suction resistance

- Testing according to the „Safety Lighting Installations for Rail Tunnels“ specifications in Germany

Maintained function is assured if no short-circuit occurs during a fire and if the current flow is not interrupted in the electrical wiring system. Components according to DIN 4102 Part 12 are high-voltage cables, installation cables and wires, busbar trunking, cable ducts, coatings, claddings and necessary fasteners, carrying equipment and fixtures. Cable testing is always performed as an entire system by inspection bodies approved by the German Institute for Building Technology (DiBt).

IP67
E90
FE180
F400
16²
IK07
690V AC/DC
DVE
halogen-free
iQ

Junction boxes WKE 54

WKE 54

278 x 208 x 107 mm



Description

Order no.

Cable junction and connection boxes with IP66 /67, certified according to EN 61439-2, With intrinsic fire resistance E30 – E90 acc. To DIN 4102 Part 12 in the bore, halogen-free enclosure made from special duroplastic, terminals made of a high-temperature-resistant special ceramic, rapid mounting by external brackets



WKE 54

860 254 01

WKE 54 5 x 16² double terminal, to be used as a junction box with fused branch, connection box 5-pole 1.5 - 16 mm², Junction box 5-pole 1.5 - 10 mm², Number of conductors per pole: 20 x 1.5² / 16 x 2.5² / 12 x 4.0² / 8 x 6² / 4 x 10² / 4 x 16², 2 fuse bases D01 max. 16 A

Accessories supplied:

2 cable glands M40 , seal range 16 - 28 mm,
1 cable gland M32, seal range 11 - 21 mm

Accessories:

KVR M20-MGM/or

227 620 01

KVR M25-MGM/or

227 625 01

KVR M32-MGM/or

227 632 01

KVR M40-MGM/or

227 640 01

Intrinsic fire resistance





- VDE tested according to EN 61 439-2
- 14-70 distribution units
- Freely plannable in accordance with the low-voltage switchgear directive
- Individually configurable with type-tested components
- Tested according to DIN 4102 part 2 by MPA Dresden
- Fire load insulation F90 (based on I90) for protection of escape and rescue routes according to MLAR 2005
- F90 (based on E90) maintained electrical function for protection of electrical equipment according to MLAR 2005
- One enclosure for all applications



Small distributors WKE AK 14-70

WKE AK 14

400 x 540 x 230 mm



Entries top end:
17 x M20
2 x M20/M25
1 x M32/M40

Description

Order no.

Fire protection small-scale distributors, VDE certificated compliant with EN 61 439 Part 2, VDE tested and certified under specific operating conditions to be compliant with EN 61 439-2, tested compliant with DIN 4102 Part 2 by MPA Dresden, F90 for internal flame impingement according to DIN 4102 based on I90, F90 for external flame impingement according to DIN 4102 based on E90, can be individually equipped with type-tested operating materials



WKE AK 14

stop left, 1-row, 14 distribution units, $U_i=400V$, screwless PE/N terminal rails each with 3 screwable clamping points, 2.5 - 16 mm², 14 screwless terminal points, 1.5 - 4 mm², elastic entries on top, with cable covering, masking and labelling strips, additional double-membrane seals and other accessories

865 414 01

WKE AK 14 R

Stop right, 1-row, 14 distribution units, $U_i=400V$, screwless PE/N terminal rails each with 3 screwable clamping points, 2.5 - 16 mm², 14 screwless terminal points, 1.5 - 16 mm², elastic entries on top, with cable covering, masking and labelling strips, additional double-membrane seals and other accessories

865 514 01

WKE AK 28

400 x 690 x 230 mm



Entries top end:
17 x M20
2 x M20/M25
1 x M32/M40

Fire protection small-scale distributors, VDE certificated compliant with EN 61 439 Part 2, VDE tested and certified under specific operating conditions to be compliant with EN 61 439-2, tested compliant with DIN 4102 Part 2 by MPA Dresden, F90 for internal flame impingement according to DIN 4102 based on I90, F90 for external flame impingement according to DIN 4102 based on E90, can be individually equipped with type-tested operating materials



WKE AK 28

stop left, 2 row, 28 distribution units, $U_i=400V$, 150 mm rail spacing, screwless PE/N terminal rails each with 3 screwable clamping points 1.5 - 4 mm², 21 / 2 x 14 screwless clamping points 1.5 mm² - 4 mm², elastic entries on top, with cable covering, masking and labelling strips, additional double-membrane seals and other accessories

865 428 01

WKE AK 28 R

Stop right, 2 row, 28 modules, $U_i=400V$, 150 mm rail spacing, screwless PE/N terminal rails each with 3 screwable clamping points 1.5 - 4 mm², 21 / 2 x 14 screwless clamping points 1.5 mm² - 4 mm², elastic entries on top, with cable covering, masking and labelling strips, additional double-membrane seals and other accessories

865 528 01

Intrinsic fire resistance

WKE AK 42
400 x 840 x 230 mm



Entries top end:
17 x M20
2 x M20/M25
1 x M32/M40

Description

Order no.

Fire protection small-scale distributors, VDE certificated compliant with EN 61 439 Part 2, VDE tested and certified under specific operating conditions to be compliant with EN 61 439-2, tested compliant with DIN 4102 Part 2 by MPA Dresden, F90 for internal flame impingement according to DIN 4102 based on I90, F90 for external flame impingement according to DIN 4102 based on E90, can be individually equipped with type-tested operating materials



WKE AK 42

stop left, 3 row, 42 distribution units, $U_i=400V$, 150 mm rail spacing, screwless PE/N terminal rails each with 6 screwable clamping points, 2.5 - 16 mm², 21 / 2 x 14 screwless clamping points 1.5 mm² - 4 mm², elastic entries on top, with cable covering, masking and labelling strips, additional double-membrane seals and other accessories

865 442 01

WKE AK 42 R

Stop right, 3 row, 42 distribution units, $U_i=400V$, 150 mm rail spacing, screwless PE/N terminal rails each with 6 screwable clamping points, 2.5 - 16 mm², 21 / 2 x 14 screwless clamping points 1.5 mm² - 4 mm², elastic entries on top, with cable covering, masking and labelling strips, additional double-membrane seals and other accessories

865 542 01

WKE AK 56
400 x 990 x 230 mm



Entries top end:
17 x M20
2 x M20/M25
1 x M32/M40

Fire protection small-scale distributors, VDE certificated compliant with EN 61 439 Part 2, VDE tested and certified under specific operating conditions to be compliant with EN 61 439-2, tested compliant with DIN 4102 Part 2 by MPA Dresden, F90 for internal flame impingement according to DIN 4102 based on I90, F90 for external flame impingement according to DIN 4102 based on E90, can be individually equipped with type-tested operating materials



WKE AK 56

stop left, 4 row, 56 distribution units, $U_i=400V$, 150 mm rail spacing, screwless PE/N terminal rails each with 6 screwable clamping points, 2.5 - 16 mm², 21 / 2 x 14 screwless clamping points 1.5 mm² - 4 mm², elastic entries on top, additional double-membrane seals and other accessories

865 456 01

WKE AK 56 R

Stop right, 4 row, 56 distribution units, $U_i=400V$, 150 mm rail spacing, screwless PE/N terminal rails each with 3 screwable clamping points, 2.5 - 16 mm², 21 / 2 x 14 screwless clamping points 1.5 mm² - 4 mm², elastic entries on top, additional double-membrane seals and other accessories

865 556 01

WKE AK 70

400 x 1.140 x 230 mm



Entries top end:
17 x M20
2 x M20/M25
1 x M32/M40

Description

Order no.

Fire protection small-scale distributors, VDE certificated compliant with EN 61 439 Part 2, VDE tested and certified under specific operating conditions to be compliant with EN 61 439-2, tested compliant with DIN 4102 Part 2 by MPA Dresden, F90 for internal flame impingement according to DIN 4102 based on I90, F90 for external flame impingement according to DIN 4102 based on E90, can be individually equipped with type-tested operating materials



WKE AK 70

70 distribution units, stop left, 5 row, $U_i=400V$, 150 mm rail spacing, screwless PE/N terminal rails each with 6 screwable clamping points, 2.5 - 16 mm², 21 / 2 x 14 screwless clamping points 1.5 mm² - 4 mm², elastic entries on top, additional double-membrane seals and other accessories

865 470 01

WKE AK 70 R

70 distribution units, Stop right, 5-row, $U_i=400V$, 150 mm rail spacing, screwless PE/N terminal rails each with 3 screwable clamping points, 2.5 - 16 mm², 21 distribution units, elastic entries on top, additional double-membrane seals and other accessories

865 570 01

WKE AK 14/2

700 x 540 x 230 mm



Entries, 2 each at the front side top:
17 x M20
2 x M20/M25
1 x M32/M40

Fire protection small-scale distributors, VDE certificated compliant with EN 61 439 Part 2, VDE tested and certified under specific operating conditions to be compliant with EN 61 439-2, tested compliant with DIN 4102 Part 2 by MPA Dresden, F90 for internal flame impingement according to DIN 4102 based on I90, F90 for external flame impingement according to DIN 4102 based on E90, can be individually equipped with type-tested operating materials



WKE AK 14/2

stop left, 1-row, 28 modules, $U_i=400V$, screwless PE/N terminal rails each with 6 screwable clamping points, 2.5 - 16 mm², 28 screwless terminals, 1.5 - 4 mm², elastic entries on top, with cable covering, masking and labelling strips, additional double-membrane seals and other accessories

865 614 01

WKE AK 14/2 R

Stop right, 1-row, 28 modules, $U_i=400V$, screwless PE/N terminal rails each with 3 screwable clamping points, 2.5 - 16 mm², 28 screwless terminals, 1.5 - 16 mm², elastic entries on top, with cable covering, masking and labelling strips, additional double-membrane seals and other accessories

865 714 01

Intrinsic fire resistance

WKE AK 28/2

700 x 690 x 230 mm



Entries, 2 each at the front side top:
17 x M20
2 x M20/M25
1 x M32/M40

Description

Order no.

Fire protection small-scale distributors, VDE certificated compliant with EN 61 439 Part 2, VDE tested and certified under specific operating conditions to be compliant with EN 61 439-2, tested compliant with DIN 4102 Part 2 by MPA Dresden, F90 for internal flame impingement according to DIN 4102 based on I90, F90 for external flame impingement according to DIN 4102 based on E90, can be individually equipped with type-tested operating materials



WKE AK 28/2

stop left, 2 row, 56 distribution units, $U_i=400V$, 150 mm rail spacing, screwless PE/N terminal rails each with 3 screwable clamping points 1.5 - 4 mm², 42 screwless terminals 1,5-4 mm², elastic entries on top, with cable covering, masking and labelling strips, additional double-membrane seals and other accessories

865 628 01

WKE AK 28/2 R

Stop right, 2 row, 56 distribution units, $U_i=400V$, 150 mm rail spacing, screwless PE/N terminal rails each with 3 screwable clamping points 1.5 - 4 mm², 42 screwless terminals 1,5-4 mm², elastic entries on top, with cable covering, masking and labelling strips, additional double-membrane seals and other accessories

865 728 01

WKE AK 42/2

700 x 840 x 230 mm



Entries, 2 each at the front side top:
17 x M20
2 x M20/M25
1 x M32/M40

Fire protection small-scale distributors, VDE certificated compliant with EN 61 439 Part 2, VDE tested and certified under specific operating conditions to be compliant with EN 61 439-2, tested compliant with DIN 4102 Part 2 by MPA Dresden, F90 for internal flame impingement according to DIN 4102 based on I90, F90 for external flame impingement according to DIN 4102 based on E90, can be individually equipped with type-tested operating materials



WKE AK 42/2

stop left, 3 row, 84 modules, $U_i=400V$, 150 mm rail spacing, screwless PE/N terminal rails each with 6 screwable clamping points, 2.5 - 16 mm², 42 screwless terminals 1,5-4 mm², elastic entries on top, with cable covering, masking and labelling strips, additional double-membrane seals and other accessories

865 642 01

WKE AK 42/2 R

Stop right, 3 row, 84 modules, $U_i=400V$, 150 mm rail spacing, screwless PE/N terminal rails each with 6 screwable clamping points, 2.5 - 16 mm², 42 screwless terminals 1,5-4 mm², elastic entries on top, with cable covering, masking and labelling strips, additional double-membrane seals and other accessories

865 742 01

WKE AK 56/2

700 x 990 x 230 mm



Entries, 2 each at the front side top:
17 x M20
2 x M20/M25
1 x M32/M40

Description

Order no.

Fire protection small-scale distributors, VDE certificated compliant with EN 61 439 Part 2, VDE tested and certified under specific operating conditions to be compliant with EN 61 439-2, tested compliant with DIN 4102 Part 2 by MPA Dresden, F90 for internal flame impingement according to DIN 4102 based on I90, F90 for external flame impingement according to DIN 4102 based on E90, can be individually equipped with type-tested operating materials



WKE AK 56/2

stop left, 4 row, 112 spacing units, $U_i=400V$, 150 mm rail spacing, screwless PE/N terminal rails each with 6 screwable clamping points, 2.5 - 16 mm², 42 screwless terminals 1,5-4 mm², elastic entries on top, additional double-membrane seals and other accessories

865 656 01

WKE AK 56/2 R

Stop right, 4 row, 112 spacing units, $U_i=400V$, 150 mm rail spacing, screwless PE/N terminal rails each with 3 screwable clamping points, 2.5 - 16 mm², 42 screwless terminals 1,5-4 mm², elastic entries on top, additional double-membrane seals and other accessories

865 756 01

WKE AK 70/2

700 x 1.140 x 230 mm



Entries, 2 each at the front side top:
17 x M20
2 x M20/M25
1 x M32/M40

Fire protection small-scale distributors, VDE certificated compliant with EN 61 439 Part 2, VDE tested and certified under specific operating conditions to be compliant with EN 61 439-2, tested compliant with DIN 4102 Part 2 by MPA Dresden, F90 for internal flame impingement according to DIN 4102 based on I90, F90 for external flame impingement according to DIN 4102 based on E90, can be individually equipped with type-tested operating materials



WKE AK 70/2

stop left, 5 row, 140 spacing units, $U_i=400V$, 150 mm rail spacing, screwless PE/N terminal rails each with 6 screwable clamping points, 2.5 - 16 mm², 42 screwless terminals 1,5-4 mm², elastic entries on top, additional double-membrane seals and other accessories

865 670 01

WKE AK 70/2 R

Stop right, 5-row, 140 spacing units, $U_i=400V$, 150 mm rail spacing, screwless PE/N terminal rails each with 3 screwable clamping points, 2.5 - 16 mm², 42 screwless terminals 1,5-4 mm², elastic entries on top, additional double-membrane seals and other accessories

865 770 01

Intrinsic fire resistance



Specially designed for tunnel systems, industrial halls and the construction industry (structural engineering).

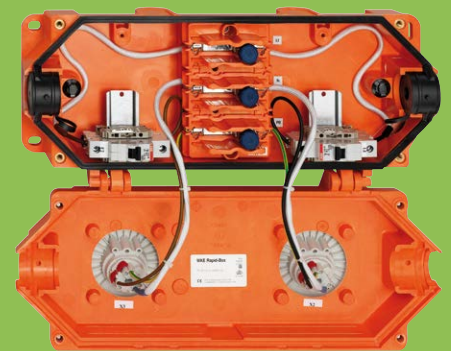

Further information at www.spelsberg.com

- Contacting of uncut conductors up to 50 mm², also retrospectively
- Maintenance-free and fused sheath terminals with rotating, sprung pressure piece and reverse lock
- Tap via spring-cage terminal
- Simplified line mounting during installation

- More economical, lower maintenance system operation
- Uninterruptible power supply via uncut conductors

Properties

- 2 basic versions:
- Standard in accordance with IEC 61439-2 (VDE)
- Functional integrity E30 / E60 / E90 per EN 1363 (MPA)

- 2 entry points with terminal to the uncut conductor branch
- Pre-wired to fuse / outlet
- With exterior mounting positions
- Dimensions: 447 x 190 x 105 mm

Product variants

- Fused branch with conductor
- CEE sockets 3-pole
- CEE sockets 5-pole

IP67
IP66

E30-
E90

50²

IK09



400V
AC/DC



low
smoke



WKE *Rapid-Box*

The VDE and MPA-certified switchgear combination

Rapid-Box 10-50² KV

190 x 446 x 106 mm



Description

Order no.

Junction box and connection enclosure certified in accordance with EN 61 439, maintenance-free terminal for uncut cables in feed-through, contacting at junction using maintenance-free spring clamp technology, simple attachment by external attachment points, halogen-free enclosure of special Duroplast, suitable for outdoor installation in accordance with EN 61439-2, terminal can withstand a rated current of max. 100 A, clamping range for uncut cables 10² - 50², clamping range for cut cables 2.5² - 35²

IP67
IP66

50²

IK09



400V
AC/DC



low
smoke



Rapid-Box 10-50² KV 1 x S

1 fuse, Sealing range cable diameter 9 - 14 mm, Terminal 50 mm²,
1-pole pre-wired junction, protected with 10 A circuit breaker

301 111 01

Rapid-Box 10-50² KV 2 x S

2 fuses, Sealing range cable diameter 9 - 14 mm, Terminal 50 mm²,
2-pole pre-wired junction, protected with 10 A circuit breaker per pole

301 121 01

Rapid-Box 10-50² STV

190 x 446 x 161 mm



Junction box and connection enclosure certified in accordance with EN 61 439, maintenance-free terminal for uncut cables in feed-through, contacting at junction using maintenance-free spring clamp technology, simple attachment by external attachment points, halogen-free enclosure of special Duroplast, suitable for outdoor installation in accordance with EN 61439-2, terminal can withstand a rated current of max. 100 A, clamping range for uncut cables 10² - 50², clamping range for cut cables 2.5² - 35²

IP67
IP66

50²

IK09



400V
AC/DC



low
smoke



Rapid-Box 10-50² STV 1 x 3-pole

1 fuse, Sealing range cable diameter 9 - 14 mm, Terminal 50 mm²,
cover with 3-pole CEE socket, pre-wired with circuit breakers

301 131 01

Rapid-Box 10-50² STV 2 x 3-pole

2 fuses, Sealing range cable diameter 9 - 14 mm, Terminal 50 mm²,
cover with two 3-pole CEE sockets, pre-wired with circuit breakers

301 141 01

Rapid-Box 10-50² STV 1 x 5-pole

3 fuses, Sealing range cable diameter 9 - 14 mm, Terminal 50 mm²,
cover with 5-pole CEE socket, pre-wired with circuit breakers

301 151 01

Rapid-Box 10-50² STV 2 x 5-pole

6 fuses, Sealing range cable diameter 9 - 14 mm, Terminal 50 mm²,
cover with 5-pole CEE socket, pre-wired with circuit breakers

301 161 01

Intrinsic fire resistance

Rapid-Box 2,5-16² KV

190 x 446 x 106 mm



Description

Order no.

Junction box and connection enclosure certified in accordance with EN 61 439, Maintenance-free terminal for uncut cables in feed-through, contacting at junction using maintenance-free spring clamp technology, simple attachment by external attachment points, halogen-free enclosure of special Duroplast, suitable for outdoor installation in accordance with EN 61439-2, Terminal can withstand a rated current of max. 63 A, Clamping range for uncut cables 2.5² - 16², clamping range for cut cables 2.5² - 10²

IP67
IP66

50²

IK09



400V
AC/DC



low
smoke



Rapid-Box 2,5-16² KV 1 x S

1 fuse, Sealing range cable diameter 9 - 14 mm, Terminal 16 mm², 1-pole pre-wired junction, protected with 10 A circuit breaker

301 011 01

Rapid-Box 2,5-16² KV 2 x S

2 fuses, Sealing range cable diameter 9 - 14 mm, Terminal 16 mm², 2-pole pre-wired junction, protected with 10 A circuit breaker per pole

301 021 01

Rapid-Box 2,5-16² STV

190 x 446 x 161 mm



Junction box and connection enclosure certified in accordance with EN 61 439, Maintenance-free terminal for uncut cables in feed-through, contacting at junction using maintenance-free spring clamp technology, simple attachment by external attachment points, halogen-free enclosure of special Duroplast, suitable for outdoor installation in accordance with EN 61439-2, Terminal can withstand a rated current of max. 63 A, Clamping range for uncut cables 2.5² - 16², clamping range for cut cables 2.5² - 10²

IP67
IP66

50²

IK09



400V
AC/DC



low
smoke



Rapid-Box 2,5-16² STV 1 x 3-pole

1 fuse, Sealing range cable diameter 9 - 14 mm, Terminal 16 mm², cover with 3-pole CEE socket, pre-wired with circuit breakers

301 031 01

Rapid-Box 2,5-16² STV 2 x 3-pole

2 fuses, Sealing range cable diameter 9 - 14 mm, Terminal 16 mm², cover with two 3-pole CEE sockets, pre-wired with circuit breakers

301 041 01

Rapid-Box 2,5-16² STV 1 x 5-pole

3 fuses, Sealing range cable diameter 9 - 14 mm, Terminal 16 mm², cover with 5-pole CEE socket, pre-wired with circuit breakers

301 051 01

Rapid box 2,5-16² STV 2 x 5-pole

6 fuses, Sealing range cable diameter 9 - 14 mm, Terminal 16 mm², cover with 5-pole CEE socket, pre-wired with circuit breakers

301 061 01

Rapid-Box E30 10-50² KV

190 x 446 x 106 mm



Description

Order no.

Junction box and connection enclosure certified in accordance with EN 61 439, MPA checked as per DIN 4102-2 and EN 1363-2, functional integrity in the feed-through 30 minutes for cable E30, suitable for max. 5-pole E30 cable, maintenance-free terminal for uncut cables in feed-through, contacting at junction using maintenance-free spring clamp technology, simple attachment by external attachment points, halogen-free enclosure of special Duroplast, suitable for outdoor installation in accordance with EN 61439-2, terminal can withstand a rated current of max. 100 A, clamping range for uncut cables 10² - 50², clamping range for cut cables 2.5² - 35²

IP67
IP66

E30-
E90

50²

IK09



400V
AC/DC



low
smoke



Rapid-Box E30 10-50² KV 1 x S

1 fuse, Sealing range cable diameter 9 - 14 mm, Terminal 50 mm², 1-pole pre-wired junction, protected with 10 A circuit breaker

301 511 01

Rapid-Box E30 10-50² KV 2 x S

2 fuses, Sealing range cable diameter 9 - 14 mm, Terminal 50 mm², 2-pole pre-wired junction, protected with 10 A circuit breaker per pole

301 521 01

Rapid-Box E30 10-50² STV

190 x 446 x 161 mm



Junction box and connection enclosure certified in accordance with EN 61 439, MPA checked as per DIN 4102-2 and EN 1363-2, functional integrity in the feed-through 30 minutes for cable E30, suitable for max. 5-pole E30 cable, maintenance-free terminal for uncut cables in feed-through, contacting at junction using maintenance-free spring clamp technology, simple attachment by external attachment points, halogen-free enclosure of special Duroplast, suitable for outdoor installation in accordance with EN 61439-2, terminal can withstand a rated current of max. 100 A, clamping range for uncut cables 10² - 50², clamping range for cut cables 2.5² - 35²

IP67
IP66

E30-
E90

50²

IK09



400V
AC/DC



low
smoke



Rapid box E30 10-50² STV 1 x 3-pole

1 fuse, Sealing range cable diameter 9 - 14 mm, Terminal 50 mm², cover with 3-pole CEE socket, pre-wired with circuit breakers

301 531 01

Rapid-Box E30 10-50² STV 2 x 3-pole

2 fuses, Sealing range cable diameter 9 - 14 mm, Terminal 50 mm², cover with two 3-pole CEE sockets, pre-wired with circuit breakers

301 541 01

Rapid-Box E30 10-50² STV 1 x 5-pole

3 fuses, Sealing range cable diameter 9 - 14 mm, Terminal 50 mm², cover with 5-pole CEE socket, pre-wired with circuit breakers

301 551 01

Rapid-Box E30 10-50² STV 2 x 5-pole

6 fuses, Sealing range cable diameter 9 - 14 mm, Terminal 50 mm², cover with 5-pole CEE socket, pre-wired with circuit breakers

301 561 01

Rapid-Box E30 2.5-16² KV

190 x 446 x 106 mm



Description

Order no.

Junction box and connection enclosure certified in accordance with EN 61 439, MPA checked as per DIN 4102-2 and EN 1363-2, functional integrity in the feed-through 30 minutes for cable E30, suitable for max. 5-pole E30 cable, maintenance-free terminal for uncut cables in feed-through, contacting at junction using maintenance-free spring clamp technology, simple attachment by external attachment points, halogen-free enclosure of special Duroplast, suitable for outdoor installation in accordance with EN 61439-2, Terminal can withstand a rated current of max. 63 A, clamping range for uncut cables 2.5² - 16², clamping range for cut cables 2.5² - 10²

IP67
IP66

E30-
E90

50²

IK09



400V
AC/DC



low
smoke



Rapid-Box E30 2,5-16² KV 1 x S

1 fuse, Sealing range cable diameter 9 - 14 mm, Terminal 16 mm²,
1-pole pre-wired junction, protected with 10 A circuit breaker

301 411 01

Rapid-Box E30 2,5-16² KV 2 x S

2 fuses, Sealing range cable diameter 9 - 14 mm, Terminal 16 mm²,
2-pole pre-wired junction, protected with 10 A circuit breaker per pole

301 421 01

Rapid-Box E30 2,5-16² STV

190 x 446 x 161 mm



Junction box and connection enclosure certified in accordance with EN 61 439, MPA checked as per DIN 4102-2 and EN 1363-2, functional integrity in the feed-through 30 minutes for cable E30, suitable for max. 5-pole E30 cable, maintenance-free terminal for uncut cables in feed-through, contacting at junction using maintenance-free spring clamp technology, simple attachment by external attachment points, halogen-free enclosure of special Duroplast, suitable for outdoor installation in accordance with EN 61439-2, Terminal can withstand a rated current of max. 63 A, clamping range for uncut cables 2.5² - 16², clamping range for cut cables 2.5² - 10²

IP67
IP66

E30-
E90

50²

IK09



400V
AC/DC



low
smoke



Rapid-Box E30 2.5-16² STV 1 x 3-pole

1 fuse, Sealing range cable diameter 9 - 14 mm, Terminal 16 mm²,
cover with 3-pole CEE socket, pre-wired with circuit breakers

301 431 01

Rapid-Box E30 2.5-16² STV 2 x 3-pole

2 fuses, Sealing range cable diameter 9 - 14 mm, Terminal 16 mm²,
cover with two 3-pole CEE sockets, pre-wired with circuit breakers

301 441 01

Rapid-Box E30 2.5-16² STV 1 x 5-pole

3 fuses, Sealing range cable diameter 9 - 14 mm, Terminal 16 mm²,
cover with 5-pole CEE socket, pre-wired with circuit breakers

301 451 01

Rapid-Box E30 2.5-16² STV 2 x 5-pole

6 fuses, Sealing range cable diameter 9 - 14 mm, Terminal 16 mm²,
cover with 5-pole CEE socket, pre-wired with circuit breakers

301 461 01

Rapid-Box E60 10-50² KV

190 x 446 x 106 mm



Description

Order no.

Junction box and connection enclosure certified in accordance with EN 61 439, MPA checked as per DIN 4102-2 and EN 1363-2, functional integrity in feed-through 60 minutes for cable E60, suitable for max. 5-pole E60 cable, maintenance-free terminal for uncut cables in feed-through, contacting at junction using maintenance-free spring clamp technology, simple attachment by external attachment points, halogen-free enclosure of special Duroplast, suitable for outdoor installation in accordance with EN 61439-2, terminal can withstand a rated current of max. 100 A, clamping range for uncut cables 10² - 50², clamping range for cut cables 2.5² - 35²

IP67
IP66

E30-
E90

50²

IK09



400V
AC/DC



low
smoke



Rapid-Box E60 10-50² KV 1 x S

1 fuse, Sealing range cable diameter 9 - 14 mm, Terminal 50 mm², 1-pole pre-wired junction, protected with 10 A circuit breaker, with external attachment lugs

301 711 01

Rapid-Box E60 10-50² KV 2 x S

2 fuses, Sealing range cable diameter 9 - 14 mm, Terminal 50 mm², 2-pole pre-wired junction, protected with 10 A circuit breaker per pole, with external attachment lugs

301 721 01

Rapid-Box E60 10-50² STV

190 x 446 x 106 mm



Junction box and connection enclosure certified in accordance with EN 61 439, MPA checked as per DIN 4102-2 and EN 1363-2, functional integrity in feed-through 60 minutes for cable E60, suitable for max. 5-pole E60 cable, maintenance-free terminal for uncut cables in feed-through, contacting at junction using maintenance-free spring clamp technology, simple attachment by external attachment points, halogen-free enclosure of special Duroplast, suitable for outdoor installation in accordance with EN 61439-2, terminal can withstand a rated current of max. 100 A, clamping range for uncut cables 10² - 50², clamping range for cut cables 2.5² - 35²

IP67
IP66

E30-
E90

50²

IK09



400V
AC/DC



low
smoke



Rapid-Box E60 10-50² STV 1 x 3-pole

1 fuse, Sealing range cable diameter 9 - 14 mm, Terminal 50 mm², cover with 3-pole CEE socket, pre-wired with circuit breakers, with external attachment lugs

301 731 01

Rapid-Box E60 10-50² STV 2 x 3-pole

2 fuses, Sealing range cable diameter 9 - 14 mm, Terminal 50 mm², cover with two 3-pole CEE sockets, pre-wired with circuit breakers, with external attachment lugs

301 741 01

Rapid-Box E60 10-50² STV 1 x 5-pole

3 fuses, Sealing range cable diameter 9 - 14 mm, Terminal 50 mm², cover with 5-pole CEE socket, pre-wired with circuit breakers, with external attachment lugs

301 751 01

Rapid-Box E60 10-50² STV 2 x 5-pole

6 fuses, Sealing range cable diameter 9 - 14 mm, Terminal 50 mm², cover with 5-pole CEE socket, pre-wired with circuit breakers, with external attachment lugs

301 761 01

Rapid-Box E60 2,5-16² KV

190 x 446 x 106 mm



Description

Order no.

Junction box and connection enclosure certified in accordance with EN 61 439, MPA checked as per DIN 4102-2 and EN 1363-2, functional integrity in feed-through 60 minutes for cable E60, suitable for max. 5-pole E60 cable, maintenance-free terminal for uncut cables in feed-through, contacting at junction using maintenance-free spring clamp technology, simple attachment by external attachment points, halogen-free enclosure of special Duroplast, suitable for outdoor installation in accordance with EN 61439-2, Terminal can withstand a rated current of max. 63 A, clamping range for uncut cables 2.5² - 16², clamping range for cut cables 2.5² - 10²



Rapid-Box E60 2.5-16² KV 1 x S

1 fuse, Sealing range cable diameter 9 - 14 mm, Terminal 16 mm², 1-pole pre-wired junction, protected with 10 A circuit breaker, with external attachment lugs

301 611 01

Rapid-Box E60 2.5-16² KV 2 x S

2 fuses, Sealing range cable diameter 9 - 14 mm, Terminal 16 mm², 2-pole pre-wired junction, protected with 10 A circuit breaker per pole, with external attachment lugs

301 621 01

Rapid-Box E60 2,5-16² STV

190 x 446 x 106 mm



Junction box and connection enclosure certified in accordance with EN 61 439, MPA checked as per DIN 4102-2 and EN 1363-2, functional integrity in feed-through 60 minutes for cable E60, suitable for max. 5-pole E60 cable, maintenance-free terminal for uncut cables in feed-through, contacting at junction using maintenance-free spring clamp technology, simple attachment by external attachment points, halogen-free enclosure of special Duroplast, suitable for outdoor installation in accordance with EN 61439-2, Terminal can withstand a rated current of max. 63 A, clamping range for uncut cables 2.5² - 16², clamping range for cut cables 2.5² - 10²



Rapid-Box E60 2.5-16² STV 1 x 3-pole

1 fuse, Sealing range cable diameter 9 - 14 mm, Terminal 16 mm², cover with 3-pole CEE socket, pre-wired with circuit breakers, with external attachment lugs

301 631 01

Rapid-Box E60 2.5-16² STV 2 x 3-pole

2 fuses, Sealing range cable diameter 9 - 14 mm, Terminal 16 mm², cover with two 3-pole CEE sockets, pre-wired with circuit breakers, with external attachment lugs

301 641 01

Rapid-Box E60 2.5-16² STV 1 x 5-pole

3 fuses, Sealing range cable diameter 9 - 14 mm, Terminal 16 mm², cover with 5-pole CEE socket, pre-wired with circuit breakers, with external attachment lugs

301 651 01

Rapid-Box E60 2.5-16² STV 2 x 5-pole

6 fuses, Sealing range cable diameter 9 - 14 mm, Terminal 16 mm², cover with 5-pole CEE socket, pre-wired with circuit breakers, with external attachment lugs

301 661 01

Rapid-Box E90 10-50² KV

190 x 446 x 106 mm

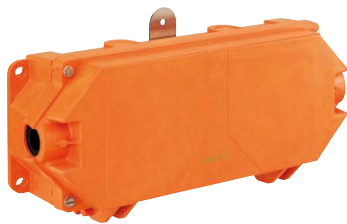

Description

Order no.

Junction box and connection enclosure certified in accordance with EN 61 439, MPA checked as per DIN 4102-2 and EN 1363-2, functional integrity in feed-through 90 minutes for cable E90, suitable for max. 5-pole E90 cable, maintenance-free terminal for uncut cables in feed-through, contacting at junction using maintenance-free spring clamp technology, simple attachment by external attachment points, halogen-free enclosure of special Duroplast, suitable for outdoor installation in accordance with EN 61439-2, terminal can withstand a rated current of max. 100 A, clamping range for uncut cables 10² - 50², clamping range for cut cables 2.5² - 35²

IP67
IP66

E30-
E90

50²

IK09



400V
AC/DC



low
smoke



Rapid-Box E90 10-50² KV 1 x S

1 fuse, Sealing range cable diameter 9 - 14 mm, Terminal 50 mm², 1-pole pre-wired junction, protected with 10 A circuit breaker, with external attachment lugs

301 311 01

Rapid-Box E90 10-50² KV 2 x S

2 fuses, Sealing range cable diameter 9 - 14 mm, Terminal 50 mm², 2-pole pre-wired junction, protected with 10 A circuit breaker per pole, with external attachment lugs

301 321 01

Rapid-Box E90 10-50² STV

190 x 446 x 106 mm

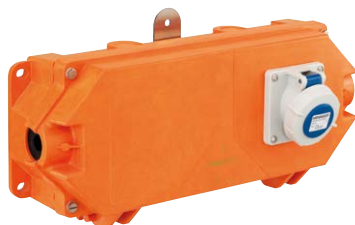

Junction box and connection enclosure certified in accordance with EN 61 439, MPA checked as per DIN 4102-2 and EN 1363-2, functional integrity in feed-through 90 minutes for cable E90, suitable for max. 5-pole E90 cable, maintenance-free terminal for uncut cables in feed-through, contacting at junction using maintenance-free spring clamp technology, simple attachment by external attachment points, halogen-free enclosure of special Duroplast, suitable for outdoor installation in accordance with EN 61439-2, terminal can withstand a rated current of max. 100 A, clamping range for uncut cables 10² - 50², clamping range for cut cables 2.5² - 35²

IP67
IP66

E30-
E90

50²

IK09



400V
AC/DC



low
smoke



Rapid-Box E90 10-50² STV 1 x 3-pole

1 fuse, Sealing range cable diameter 9 - 14 mm, Terminal 50 mm², cover with 3-pole CEE socket, pre-wired with circuit breakers, with external attachment lugs

301 331 01

Rapid-Box E90 10-50² STV 2 x 3-pole

2 fuses, Sealing range cable diameter 9 - 14 mm, Terminal 50 mm², cover with two 3-pole CEE sockets, pre-wired with circuit breakers, with external attachment lugs

301 341 01

Rapid-Box E90 10-50² STV 1 x 5-pole

3 fuses, Sealing range cable diameter 9 - 14 mm, Terminal 50 mm², cover with 5-pole CEE socket, pre-wired with circuit breakers, with external attachment lugs

301 351 01

Rapid-Box E90 10-50² STV 2 x 5-pole

6 fuses, Sealing range cable diameter 9 - 14 mm, Terminal 50 mm², cover with 5-pole CEE socket, pre-wired with circuit breakers, with external attachment lugs

301 361 01

Rapid-Box E90 2,5-16² KV

190 x 446 x 106 mm



Description

Order no.

Junction box and connection enclosure certified in accordance with EN 61 439, MPA checked as per DIN 4102-2 and EN 1363-2, functional integrity in feed-through 90 minutes for cable E90, suitable for max. 5-pole E90 cable, maintenance-free terminal for uncut cables in feed-through, contacting at junction using maintenance-free spring clamp technology, simple attachment by external attachment points, halogen-free enclosure of special Duroplast, suitable for outdoor installation in accordance with EN 61439-2, Terminal can withstand a rated current of max. 63 A, clamping range for uncut cables 2.5² - 16², clamping range for cut cables 2.5² - 10²

IP67
IP66

E30-
E90

50²

IK09



400V
AC/DC



low
smoke



Rapid-Box E90 2.5-16² KV 1 x S

1 fuse, Sealing range cable diameter 9 - 14 mm, Terminal 16 mm²,
1-pole pre-wired junction, protected with 10 A circuit breaker,
with external attachment lugs

301 211 01

Rapid-Box E90 2.5-16² KV 2 x S

2 fuses, Sealing range cable diameter 9 - 14 mm, Terminal 16 mm²,
2-pole pre-wired junction, protected with 10 A circuit breaker per pole,
with external attachment lugs

301 221 01

Rapid-Box E90 2,5-16² STV

190 x 446 x 106 mm

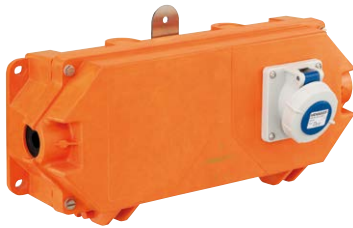

Description

Order no.

Junction box and connection enclosure certified in accordance with EN 61 439, MPA checked as per DIN 4102-2 and EN 1363-2, functional integrity in feed-through 90 minutes for cable E90, suitable for max. 5-pole E90 cable, maintenance-free terminal for uncut cables in feed-through, contacting at junction using maintenance-free spring clamp technology, simple attachment by external attachment points, halogen-free enclosure of special Duroplast, suitable for outdoor installation in accordance with EN 61439-2, Terminal can withstand a rated current of max. 63 A, clamping range for uncut cables 2.5² - 16², clamping range for cut cables 2.5² - 10²

IP67
IP66

E30-
E90

50²

IK09



400V
AC/DC



low
smoke



Rapid-Box E90 2.5-16² STV 1 x 3-pole

1 fuse, Sealing range cable diameter 9 - 14 mm, Terminal 16 mm², cover with 3-pole CEE socket, pre-wired with circuit breakers, with external attachment lugs

301 231 01

Rapid-Box E90 2.5-16² STV 2 x 3-pole

2 fuses, Sealing range cable diameter 9 - 14 mm, Terminal 16 mm², cover with two 3-pole CEE sockets, pre-wired with circuit breakers, with external attachment lugs

301 241 01

Rapid-Box E90 2.5-16² STV 1 x 5-pole

3 fuses, Sealing range cable diameter 9 - 14 mm, Terminal 16 mm², cover with 5-pole CEE socket, pre-wired with circuit breakers, with external attachment lugs

301 251 01

Rapid-Box E90 2.5-16² STV 2 x 5-pole

6 fuses, Sealing range cable diameter 9 - 14 mm, Terminal 16 mm², cover with 5-pole CEE socket, pre-wired with circuit breakers, with external attachment lugs

301 261 01

Intrinsic fire resistance

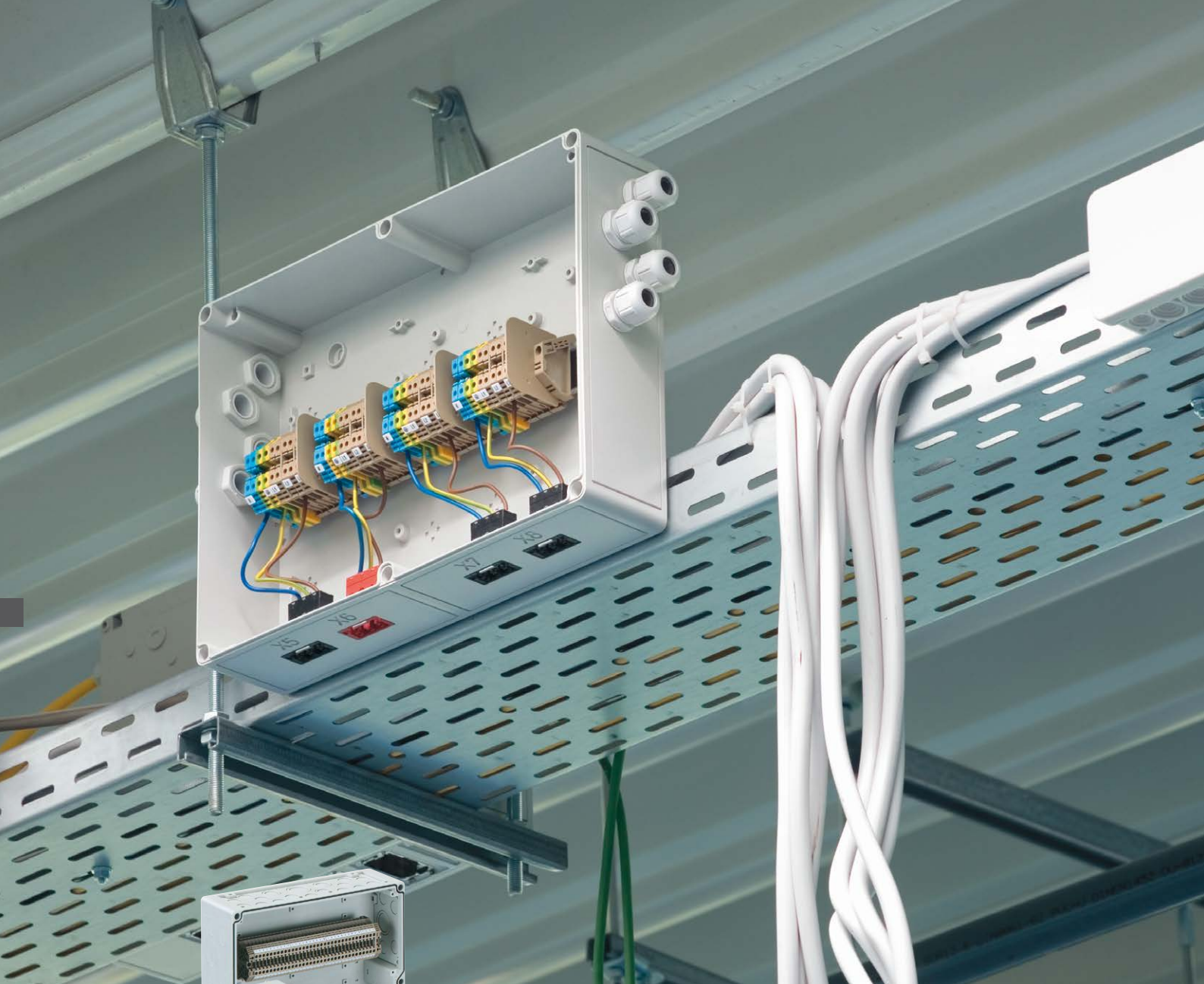

Empty or fully fitted, compact or with plenty of space for up to 136 terminals - RK terminal block housings from Spelsberg offer space for a variety of solutions for every installation.

	Protection rating	Number of terminals	Types	Page
	IP66	5 to 22 x 4 ²	Terminal block housings with terminal blocks RK Compact	120-123
	IP66 / IP54	5 to 22 x 4 ²	Terminal block housings with terminal blocks RKi Compact	124-127
	IP66	7 to 100 x 4 ²	Terminal block housings RK	128-131
	IP65	34 to 136 x 4 ²	Terminal block housings combinable RKA	132-135
	IP65	34 to 136 x 4 ²	Terminal block housings combinable, industrial quality AKi-R	132-135
	IP66	5 to 22 x 4 ²	Aluminium terminal block housings ALR Compact	136-138
	IP66	14 to 47 x 4 ²	Aluminium terminal block housings ALR-L	137-138
	General accessories for terminal block housings			139

RKK 4/05

94 x 65 x 57 mm

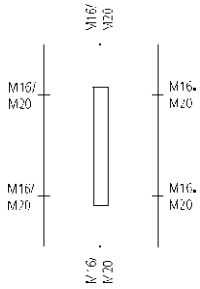

Description

Order no.

Terminal block enclosure, flat design, Polystyrene, light grey, similar to RAL 7035, equipped with 5-pole terminal block 0.2-4 mm² (screw connection), incl. 3 attachment bushes M20, seal range 8 - 13.5 mm, IP54

IP66
IP54
4²
IK07
400V
AC
halogen-free

RKK 4/05-5x4²

605 404 01

RKK 4/07

RKK 4/08

94 x 94 x 57 mm

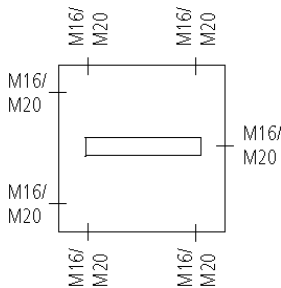

Terminal block enclosure, flat design, Polystyrene, light grey, similar to RAL 7035, equipped with 7- or 8-pole terminal block 0.2-4 mm² (screw connection), incl. 4 attachment bushes M20, seal range 8 - 13.5 mm, IP54

IP66
IP54
4²
IK07
400V
AC
halogen-free

RKK 4/07-7x4²
(with 7-pole block terminal)

600 407 01

RKK 4/08-8x4²
(with 8-pole block terminal)

606 404 01

RKK 4/10

94 x 94 x 57 mm

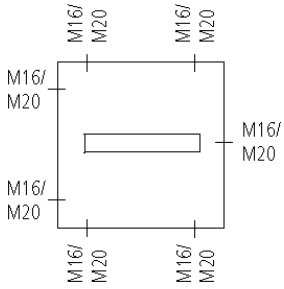

Description

Order no.

Terminal block enclosure, flat design, Polystyrene, light grey, similar to RAL 7035, equipped with 10-pole terminal block 0.2-4 mm² (screw connection), incl. 4 attachment bushes M20, seal range 8 - 13.5 mm, IP54

IP66
IP54

4²

IK07



400V
AC



RKK 4/10-10x4²

607 404 01

RKK 4/12

110 x 110 x 66 mm

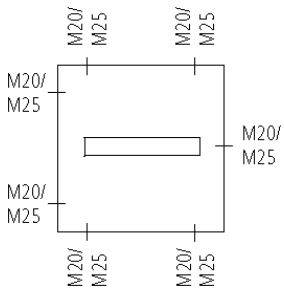

Terminal block enclosure, flat design, Polystyrene, light grey, similar to RAL 7035, equipped with 12-pole terminal block 0.2-4 mm² (screw connection), incl. 4 attachment bushes M20, seal range 8 - 13.5 mm, IP54

IP66
IP54

4²

IK07



400V
AC



RKK 4/12-12x4²

610 404 01

RKK 4/12 XL
130 x 94 x 57 mm

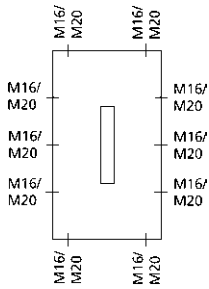

Description

Order no.

Terminal block enclosure, flat design, Polystyrene, light grey, similar to RAL 7035, equipped with 12-pole terminal block 0.2-4 mm² (screw connection), incl. 6 attachment bushes M20, seal range 8 - 13.5 mm, IP54

IP66
IP54
4²
IK07
400V
AC
halogen-free

RKK 4/12 XL-12x4²

600 412 01

RKK 4/15

130 x 94 x 57 mm

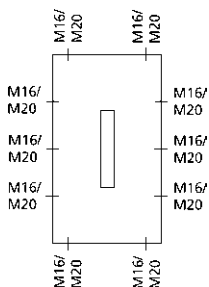

Terminal block enclosure, flat design, Polystyrene, light grey, similar to RAL 7035, equipped with 15-pole terminal block 0.2-4 mm² (screw connection), incl. 6 attachment bushes M20, seal range 8 - 13.5 mm, IP54

IP66
IP54
4²
IK07
400V
AC
halogen-free

RKK 4/15-15x4²

612 404 01

RKK 4/18

180 x 94 x 57 mm

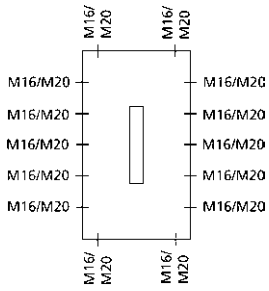

Description

Order no.

Terminal block enclosure, flat design, Polystyrene, light grey, similar to RAL 7035, equipped with 18-pole terminal block 0.2-4 mm² (screw connection), incl. 6 attachment bushes M20, seal range 8 - 13.5 mm, IP54

IP66
IP54

4²

IK07



400V
AC



RKK 4/18-18x4²

600 418 01

RKK 4/22

180 x 94 x 57 mm

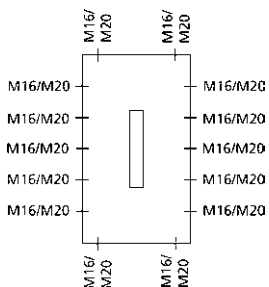
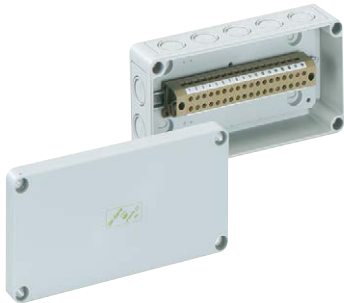

Terminal block enclosure, flat design, Polystyrene, light grey, similar to RAL 7035, equipped with 22-pole terminal block 0.2-4 mm² (screw connection), incl. 6 attachment bushes M20, seal range 8 - 13.5 mm, IP54

IP66
IP54

4²

IK07



400V
AC



RKK 4/22-22x4²

614 404 01

RKKi 4/05

94 x 65 x 57 mm

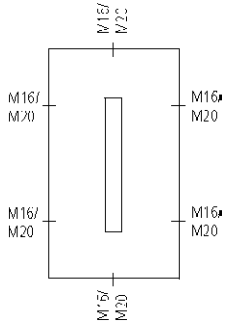

Description

Order no.

Terminal block enclosure, flat design, polycarbonate, grey similar RAL 7035, equipped with 5-pole terminal block 0.2-4 mm² (screw connection), incl. 3 attachment bushes M20, seal range 8 - 13.5 mm, IP54

IP66
IP54

4²

IK08



400V
AC



RKKi 4/05-5x4²

635 404 01

RKKi 4/07

RKKi 4/08

94 x 94 x 57 mm

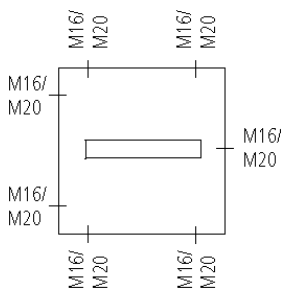

Terminal block enclosure, flat design, polycarbonate, grey similar RAL 7035, equipped with 7- or 8-pole terminal block 0.2-4 mm² (screw connection), incl. 4 attachment bushes M20, seal range 8 - 13.5 mm, IP54

IP66
IP54

4²

IK08



400V
AC



RKKi 4/07-7x4²

(with 7-pole block terminal)

630 407 01

RKKi 4/08-8x4²

(with 8-pole block terminal)

636 404 01

RKKi 4/10

94 x 94 x 57 mm

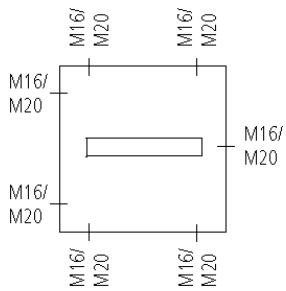

Description

Order no.

Terminal block enclosure, flat design, polycarbonate, grey similar RAL 7035, equipped with 10-pole terminal block 0.2-4 mm² (screw connection), incl. 4 attachment bushes M20, seal range 8 - 13.5 mm, IP54

IP66
IP54

4²

IK08



400V
AC



RKKi 4/10-10x4²

637 404 01

RKKi 4/12

110 x 110 x 66 mm

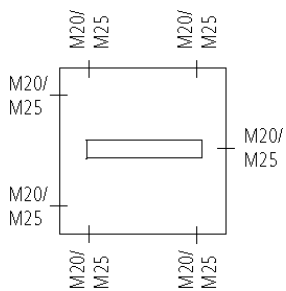

Terminal block enclosure, flat design, polycarbonate, grey similar RAL 7035, equipped with 12-pole terminal block 0.2-4 mm² (screw connection), incl. 4 attachment bushes M20, seal range 8 - 13.5 mm, IP54

IP66
IP54

4²

IK08



400V
AC



RKKi 4/12-12x4²

630 404 01

RKKi 4/12 XL

130 x 94 x 57 mm

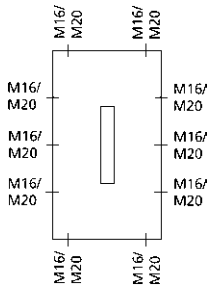

Description

Order no.

Terminal block enclosure, flat design, polycarbonate, grey similar RAL 7035, equipped with 12-pole terminal block 0.2-4 mm² (screw connection), incl. 6 attachment bushes M20, seal range 8 - 13.5 mm, IP54

IP66
IP54

4²

IK08



400V
AC



RKKi 4/12 XL-12x4²

630 412 01

RKKi 4/15

130 x 94 x 57 mm

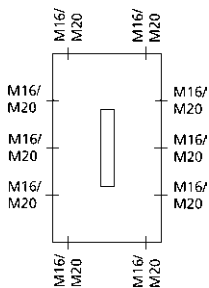

Terminal block enclosure, flat design, polycarbonate, grey similar RAL 7035, equipped with 15-pole terminal block 0.2-4 mm² (screw connection), incl. 6 attachment bushes M20, seal range 8 - 13.5 mm, IP54

IP66
IP54

4²

IK08



400V
AC



RKKi 4/15-15x4²

632 404 01

RKKi 4/18

180 x 94 x 57 mm

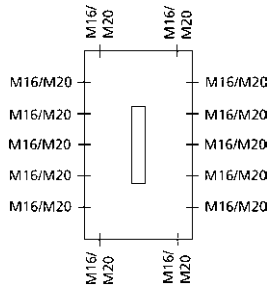

Description

Order no.

Terminal block enclosure, flat design, polycarbonate, grey similar RAL 7035, equipped with 18-pole terminal block 0.2-4 mm² (screw connection), incl. 6 attachment bushes M20, seal range 8 - 13.5 mm, IP54

IP66
IP54

4²

IK08



400V
AC



RKKi 4/18-18x4²

630 418 01

RKKi 4/22

180 x 94 x 57 mm

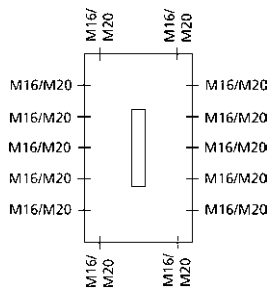
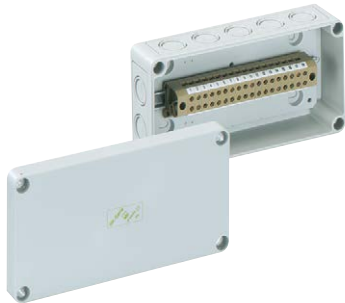

Terminal block enclosure, flat design, polycarbonate, grey similar RAL 7035, equipped with 22-pole terminal block 0.2-4 mm² (screw connection), incl. 6 attachment bushes M20, seal range 8 - 13.5 mm, IP54

IP66
IP54

4²

IK08



400V
AC



RKKi 4/22-22x4²

634 404 01

RK 4/07

110 x 110 x 90 mm

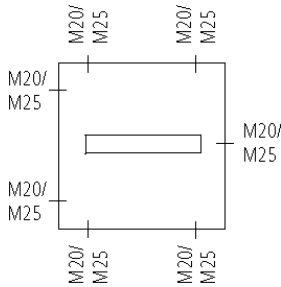

Description

Order no.

Terminal block enclosure, Polystyrene, light grey, similar to RAL 7035, incl. 4 attachment bushes M20, seal range 8 - 13.5 mm, IP54, 1 attachment bush M25, seal range 9 - 18.5 mm, IP54

IP66
IP54

IK07



RK 4/07-L

without terminals, with NS 35

619 907 01

RK 4/07-7x4²

with 7 screw terminals 4 mm², (type Weidmüller WDU 4)

615 007 01

RK 4/07 SL-7x4²

with 7 screwless terminals 4 mm², (type Weidmüller ZDU 4)

610 007 01

RK 4/12

130 x 130 x 75 mm

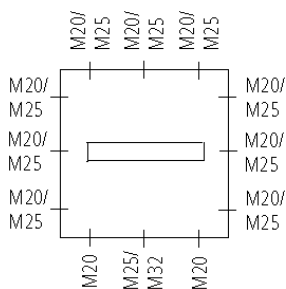

Terminal block enclosure, Polystyrene, light grey, similar to RAL 7035, incl. 4 attachment bushes M20, seal range 8 - 13.5 mm, IP54, 1 attachment bush M25, seal range 9 - 18.5 mm, IP54

IP66
IP54

IK07



RK 4/12-L

without terminals, with NS 35

613 906 01

RK 4/12-12x4²

with 12 screw terminals 4 mm², (type Weidmüller WDU 4)

615 012 01

RK 4/12 SL-12x4²

with 12 screwless terminals 4 mm², (type Weidmüller ZDU 4)

610 012 01

RK 4/18 K

180 x 110 x 90 mm

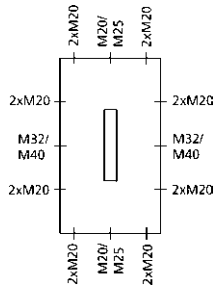

Description

Order no.

Terminal block enclosure, Polystyrene, light grey, similar to RAL 7035, incl. 8 attachment bushes M20, seal range 8 - 13.5 mm, IP54, 2 attachment bushes M25, seal range 9 - 18.5 mm, IP54, 1 attachment bush M32, seal range 13 - 23 mm, IP54

IP66
IP54

IK07



RK 4/18 K-L
without terminals, with NS 35

615 912 01

RK 4/18 K-18x4²
with 18 screw terminals 4 mm², (type Weidmüller WDU 4)

615 018 01

RK 4/18 KSL-18x4²
with 18 screwless terminals 4 mm², (type Weidmüller ZDU 4)

610 018 01

RK 4/18

182 x 180 x 90 mm

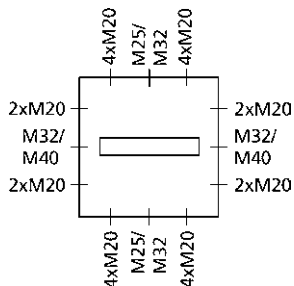

Terminal block enclosure, Polystyrene, light grey, similar to RAL 7035, incl. 8 attachment bushes M20, seal range 8 - 13.5 mm, IP54, 2 attachment bushes M25, seal range 9 - 18.5 mm, IP54, 1 attachment bush M32, seal range 13 - 23 mm, IP54

IP66
IP54

IK07



RK 4/18-L
without terminals, with NS 35

616 912 01

RK 4/18-18x4²
with 18 screw terminals 4 mm², (type Weidmüller WDU 4)

615 019 01

RK 4/18 SL-18x4²
with 18 screwless terminals 4 mm², (type Weidmüller ZDU 4)

610 019 01

RK 4/25

254 x 180 x 90 mm

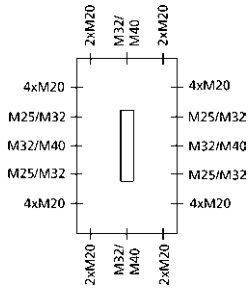

Description

Order no.

Terminal block enclosure, Polystyrene, light grey, similar to RAL 7035, incl. 8 attachment bushes M20, seal range 8 - 13.5 mm, IP54, 2 attachment bushes M25, seal range 9 - 18.5 mm, IP54, 1 attachment bush M32, seal range 13 - 23 mm, IP54

IP66
IP54

IK07



RK 4/25-L
without terminals, with NS 35

625 916 01

RK 4/25-25x4²
with 25 screw terminals 4 mm², (type Weidmüller WDU 4)

615 025 01

RK 4/25 SL-25x4²
with 25 screwless terminals 4 mm², (type Weidmüller ZDU 4)

610 025 01

RK 4/34

254 x 180 x 90 mm

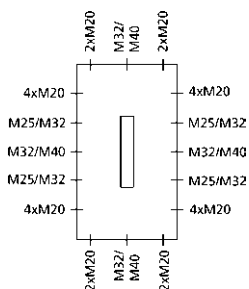

Terminal block enclosure, with standard rails NS 35, incl. 8 attachment bushes M20, seal range 8 - 13.5 mm, IP54, 2 attachment bushes M25, seal range 9 - 18.5 mm, IP54, 1 attachment bush M32, seal range 13 - 23 mm, IP54

IP66
IP54

IK07



RK 4/34-L
without terminals, with NS 35

625 917 01

RK 4/34-34x4²
with 34 screw terminals 4 mm², (type Weidmüller WDU 4)

615 034 01

RK 4/34 SL-34x4²
with 34 screwless terminals 4 mm², (type Weidmüller ZDU 4)

610 034 01

RK 4/50

360 x 254 x 111 mm

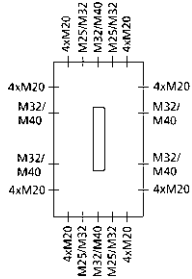

Description

Order no.

Terminal block enclosure, Polystyrene, light grey, similar to RAL 7035, incl. 18 attachment bushes M20, seal range 8 - 13.5 mm, IP54, 4 IP54 attachment bushes M25, seal range 9 - 18.5 mm, 2 attachment bushes M32, Seal range 11 - 23 mm, IP54, 1 attachment bush M40, seal range 17 - 30 mm, IP54

IP66
IP54

IK07



RK 4/50-L

without terminals, with NS 35

616 950 01

RK 4/50-50x4²

with 50 screw terminals 4 mm², (type Weidmüller WDU 4)

615 050 01

RK 4/50 SL-50x4²

with 50 screwless terminals 4 mm², (type Weidmüller ZDU 4)

610 050 01

RK 4/100

360 x 254 x 111 mm

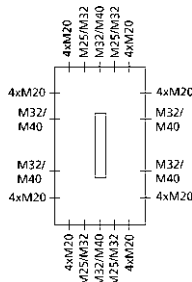

Terminal block enclosure, Polystyrene, light grey, similar to RAL 7035, incl. 18 attachment bushes M20, seal range 8 - 13.5 mm, IP54, 4 IP54 attachment bushes M25, seal range 9 - 18.5 mm, 2 attachment bushes M32, seal range 13 - 23 mm, IP54, 1 attachment bush M40, seal range 17 - 30 mm, IP54

IP66
IP54

IK07



RK 4/100-L

without terminals, with NS 35

626 922 01

RK 4/100-100x4²

with 100 screw terminals 4 mm², (type Weidmüller WDU 4)

615 100 01

RK 4/100 SL-100x4²

with 100 screwless terminals 4 mm², (type Weidmüller ZDU 4)

610 100 01

RKA 4/34

300 x 150 x 132 mm



Entries end:
15 x M20
2 x M20/M25
1 x M32/M40
Entries on each side:
4 x M20
1 x M25/M32

Description

Order no.

Terminal block enclosure, incl. 10 DMS nozzle M20, seal range 7 - 12 mm, 2 DMS seals M25, seal range 9 - 16 mm, 2 DMS nozzles M32, seal range 14 - 21 mm, 1 DMS seals M40, Sealing range 19 - 28 mm

IP65

IK07



RKA 4/34-L

without terminals, with NS 35

629 901 01

RKA 4/34-34x4²

with 34 screw terminals 4 mm², (type Weidmüller WDU 4)

625 034 01

RKA 4/34 SL-34x4²

with 34 screwless terminals 4 mm², (type Weidmüller ZDU 4)

620 034 01

AKi-R 4/34

300 x 150 x 132 mm



Entries end:
15 x M20
2 x M20/M25
1 x M32/M40
Entries on each side:
4 x M20
1 x M25/M32

Terminal strip enclosure - industrial quality - , incl. 10 DMS nozzle M20, seal range 7 - 12 mm, 2 DMS seals M25, seal range 9 - 16 mm, 2 DMS nozzles M32, seal range 14 - 21 mm, 1 DMS seals M40, Sealing range 19 - 28 mm

IP65

IK08



AKi-R 4/34-L

without terminals, with NS 35

741 901 01

AKi-R 4/34

with 34 screw terminals 4 mm², (type Weidmüller WDU 4)

742 034 01

AKi-R 4/34-SL

with 34 screwless terminals 4 mm², (type Weidmüller ZDU 4)

743 034 01

RKA 4/68

300 x 300 x 132 mm



Entries top end:
15 x M20
2 x M20/M25
1 x M32/M40
Entries bottom end:
2 x M20
2 x M32/M40/M50
1 x M40/M50/M63
Entries on each side:
4 x M20
1 x M25/M32
1 x M32/M40/M50

Description

Order no.

Terminal block enclosure, incl. 10 DMS nozzle M20, seal range 7 - 12 mm, 2 DMS seals M25, seal range 9 - 16 mm, 2 DMS nozzles M32, seal range 14 - 21 mm, 1 DMS seals M40, Sealing range 19 - 28 mm, IP66, 2 twist nipples M50 incl. lock nut, IP54

IP65
IP54

IK07



RKA 4/68-L
without terminals, with NS 35

629 902 01

RKA 4/68-68x4²
with 68 screw terminals 4 mm², (type Weidmüller WDU 4)

625 068 01

RKA 4/68 SL-68x4²
with 68 screwless terminals 4 mm², (type Weidmüller ZDU 4)

620 068 01

AKi-R 4/68

300 x 300 x 132 mm



Entries top end:
15 x M20
2 x M20/M25
1 x M32/M40
Entries bottom end:
2 x M20
2 x M32/M40/M50
1 x M40/M50/M63
Entries on each side:
4 x M20
1 x M25/M32
1 x M32/M40/M50

Terminal strip enclosure - industrial quality - , incl. 10 DMS nozzle M20, seal range 7 - 12 mm, 2 DMS seals M25, seal range 9 - 16 mm, 2 DMS nozzles M32, seal range 14 - 21 mm, 1 DMS seals M40, Sealing range 19 - 28 mm, IP66, 2 twist nipples M50 incl. lock nut, IP54

IP65
IP54

IK08



AKi-R 4/68-L
without terminals, with NS 35

741 902 01

AKi-R 4/68
with 68 screw terminals 4 mm², (type Weidmüller WDU 4)

742 068 01

AKi-R 4/68-SL
with 68 screwless terminals 4 mm², (type Weidmüller ZDU 4)

743 068 01

RKA 4/102

300 x 450 x 132 mm



Entries top end:

15 x M20

2 x M20/M25

1 x M25/M32

Entries bottom end:

2 x M20

2 x M32/M40

1 x M40/M50/M63

Entries on each side:

8 x M20

2 x M25/M32

1 x M32/M40/M50

Description

Order no.

Terminal block enclosure, incl. 10 DMS nozzle M20, seal range 7 - 12 mm, 2 DMS seals M25, seal range 9 - 16 mm, 2 DMS nozzles M32, seal range 14 - 21 mm, 1 DMS seals M40, Sealing range 19 - 28 mm, IP66, 2 twist nipples M50 incl. lock nut, IP54

IP65
IP54

IK07



RKA 4/102-L

without terminals, with NS 35

629 903 01

RKA 4/102-102x4²

with 102 screw terminals 4 mm², (type Weidmüller WDU 4)

625 102 01

RKA 4/102 SL-102x4²

with 102 screwless terminals 4 mm², (type Weidmüller ZDU 4)

620 102 01

AKi-R 4/102

300 x 450 x 132 mm



Entries top end:

15 x M20

2 x M20/M25

1 x M25/M32

Entries bottom end:

2 x M20

2 x M32/M40

1 x M40/M50/M63

Entries on each side:

8 x M20

2 x M25/M32

1 x M32/M40/M50

Terminal strip enclosure - industrial quality - , incl. 10 DMS nozzle M20, seal range 7 - 12 mm, 2 DMS seals M25, seal range 9 - 16 mm, 2 DMS nozzles M32, seal range 14 - 21 mm, 1 DMS seals M40, Sealing range 19 - 28 mm, IP66, 2 twist nipples M50 incl. lock nut, IP54

IP65
IP54

IK08



AKi-R 4/102-L

without terminals, with NS 35

741 903 01

AKi-R 4/102

with 102 screw terminals 4 mm², (type Weidmüller WDU 4)

742 102 01

AKi-R 4/102-SL

with 102 screwless terminals 4 mm², (type Weidmüller ZDU 4)

743 102 01

RKA 4/136

300 x 600 x 132 mm



Entries top end:
15 x M20
2 x M20/M25
2 x M25/M32
Entries bottom end:
2 x M20
2 x M32/M40
1 x M40/M50/M63
Entries on each side:
12 x M20
3 x M25/M32
1 x M32/M40/M50

Description

Order no.

Terminal block enclosure, incl. 10 DMS nozzle M20, seal range 7 - 12 mm, 2 DMS seals M25, seal range 9 - 16 mm, 2 DMS nozzles M32, seal range 14 - 21 mm, 1 DMS seals M40, Sealing range 19 - 28 mm, IP66, 2 twist nipples M50 incl. lock nut, IP54

IP65
IP54

IK07



RKA 4/136-L

without terminals, with NS 35

629 904 01

RKA 4/136-136x4²

with 136 screw terminals 4 mm², (type Weidmüller WDU 4)

625 136 01

RKA 4/136 SL-136x4²

with 136 screwless terminals 4 mm², (type Weidmüller ZDU 4)

620 136 01

AKi-R 4/136

300 x 600 x 132 mm



Entries top end:
15 x M20
2 x M20/M25
1 x M25/M32
Entries bottom end:
2 x M20
2 x M32/M40
1 x M40/M50/M63
Entries on each side:
12 x M20
3 x M25/M32
1 x M32/M40/M50

Terminal strip enclosure - industrial quality - , incl. 10 DMS nozzle M20, seal range 7 - 12 mm, 2 DMS seals M25, seal range 9 - 16 mm, 2 DMS nozzles M32, seal range 14 - 21 mm, 1 DMS seals M40, Sealing range 19 - 28 mm, IP66, 2 twist nipples M50 incl. lock nut, IP54

IP65
IP54

IK08



AKi-R 4/136-L

without terminals, with NS 35

741 904 01

AKi-R 4/136

with 136 screw terminals 4 mm², (type Weidmüller WDU 4)

742 136 01

AKi-R 4/136-SL

with 136 screwless terminals 4 mm², (type Weidmüller ZDU 4)

743 136 01

ALR 88-4
75 x 80 x 57 mm



Description

Order no.

Terminal block enclosure in compact design - Industrial Quality - Aluminium, powder-coated painting silver grey RAL 7001, equipped with 5-pole terminal block 0.2-4 mm² (screw connection)



ALR 88-4 ²	160 405 01
-----------------------	------------

ALR 1308-4
125 x 80 x 57 mm



Terminal block enclosure in compact design - Industrial Quality - Aluminium, powder-coated painting silver grey RAL 7001, equipped with 12-pole terminal block 0.2-4 mm² (screw connection)



ALR 1308-4 ²	160 406 01
-------------------------	------------

ALR 1808-4
175 x 80 x 57 mm

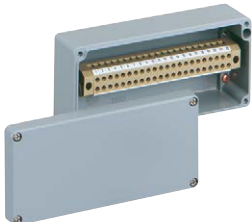

Terminal block enclosure in compact design - Industrial Quality - Aluminium, powder-coated painting silver grey RAL 7001, equipped with 22-pole terminal block 0.2-4 mm² (screw connection)



ALR 1808-4 ²	160 407 01
-------------------------	------------

ALR 1010-4
100 x 100 x 81 mm



Terminal block enclosure in compact design - Industrial Quality - Aluminium, powder-coated painting silver grey RAL 7001, equipped with 10-pole terminal block 0.2-4 mm² (screw connection)



ALR 1010-4 ²	160 408 01
-------------------------	------------

ALR 1212
122 x 120 x 81 mm



Description

Order no.

Terminal block enclosure in compact design - Industrial Quality - Aluminium, powder-coated painting silver grey RAL 7001



ALR 1212-L without terminals, with NS 35	160 909 01
ALR 1212-4² fitted with 14 screw terminals 4 mm ²	160 409 01

ALR 2212
220 x 120 x 81 mm

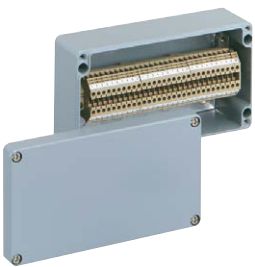

Terminal block enclosure - Industrial Quality - Aluminium, powder-coated painting silver grey RAL 7001



ALR 2212-L without terminals, with NS 35	160 910 01
ALR 2212-4² fitted with 30 screw terminals 4 mm ²	160 410 01

ALR 1616
160 x 160 x 91 mm

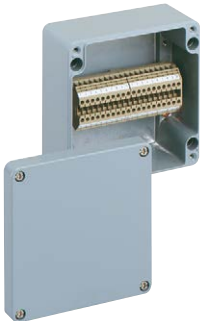

Terminal block enclosure - Industrial Quality - Aluminium, powder-coated painting silver grey RAL 7001



ALR 1616-L without terminals, with NS 35	160 911 01
ALR 1616-4² fitted with 20 screw terminals 4 mm ²	160 411 01

ALR 2616
260 x 160 x 91 mm

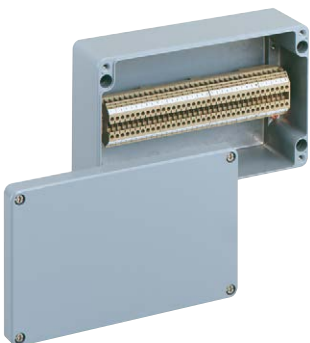

Terminal block enclosure - Industrial Quality - Aluminium, powder-coated painting silver grey RAL 7001



ALR 2616-L without terminals, with NS 35	160 912 01
ALR 2616-4² fitted with 36 screw terminals 4 mm ²	160 412 01

Terminal block housings

ALR 3616

360 x 160 x 91 mm



Description

Order no.

Terminal block enclosure - Industrial Quality - Aluminium, powder-coated painting silver grey RAL 7001

IP66

IK09



ALR 3616-L
without terminals, with NS 35

160 913 01

ALR 3616-4²
fitted with 52 screw terminals 4 mm²

160 413 01

ALR 2320

230 x 200 x 111 mm



Terminal block enclosure - Industrial Quality - Aluminium, powder-coated painting silver grey RAL 7001

IP66

IK09



ALR 2320-L
without terminals, with NS 35

160 914 01

ALR 2320-4²
fitted with 40 screw terminals 4 mm²

160 414 01

ALR 2823

280 x 230 x 111 mm

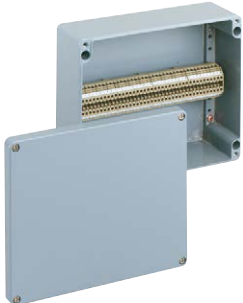

Terminal block enclosure - Industrial Quality - Aluminium, powder-coated painting silver grey RAL 7001

IP66

IK09



ALR 2823-L
without terminals, with NS 35

160 915 01

ALR 2823-4²
fitted with 40 screw terminals 4 mm²

160 415 01

ALR 3323

330 x 230 x 111 mm



Terminal block enclosure - Industrial Quality - Aluminium, powder-coated painting silver grey RAL 7001

IP66

IK09



ALR 3323-L
without terminals, with NS 35

160 916 01

ALR 3323-4²
fitted with 47 screw terminals 4 mm²

160 416 01

Cable gland



IP68

Description

Cable gland with strain relief, polyamide, M_ x 1.5 mm, with lock nut

Order no.

	Thread length/mm	Sealing area/mm	
KVR M12-MGM	8	2 - 6.5	227 412 01
KVR M16-MGM	8	4 - 10.0	227 416 01
KVR M20-MGM	9	6 - 12.0	227 420 01
KVR M20-GDB/MGM	9	7 - 14.0	227 421 01
KVR M25-MGM	11	9 - 16	227 425 01
KVR M32-MGM	11	11 - 21.0	227 432 01
KVR M40-MGM	11	16 - 28.0	227 440 01
KVR M50-MGM	13	21 - 34.5	227 450 01
KVR M63-MGM	17	30 - 44.5	227 463 01

Double membrane seals



IP66

Double membrane seals made of elastic plastic with two sealing membranes, closed

	f. wall thicknesses/mm	Sealing area/mm	
DMS M16	1.5 - 4.5	5 - 9	260 416 01
DMS M20	1.5 - 4.5	7 - 12	260 420 01
DMS M25	1.5 - 4.5	9 - 16	260 425 01
DMS M32	1.5 - 4.5	14 - 21	260 432 01
DMS M40	1.5 - 4.5	19 - 28	260 440 01

Attachment bushes



IP54









Attachment bushes with open sealing membrane, no lock nuts required

	Sealing area/mm	
AST M16	6 - 10	230 416 01
AST M20	8 - 13.5	230 420 01
AST M25	9 - 18.5	230 425 01
AST M32	13 - 23	230 432 01
AST M40	17 - 30	230 440 01



With a rail spacing of 150 millimetres, the AK series of small distributors provides plenty of space for wiring the installed devices. The screwless PE/N terminal rails also ensure safe and time-saving installation.

Distribution boards AK

	Protection rating	Distribution units	Types	Page
	IP65 NEW!	14 - 70 TE	Distribution boards, with innovative Air-Technology AK / AK Plus	142-148
	IP65 NEW!	14 - 70 TE	Distribution boards, with innovative Air-Technology AK-F / AK-F Plus (Flange type) Flange type	147-148
	IP65	-	Expansion enclosure / empty enclosure AK 14 L / AK-F 14 L + AK-F/DMS 14 L (Flange type) Flange type	149-151
	Accessories for AK			152-153
	IP55	3 - 48 TE	Distribution boards AKe	154-157
	IP65	3 - 24 TE	Distribution boards in compact design AK Compact	158-159
	IP65	3 - 24 TE	Distribution boards in compact design AKi Compact	160-161
	Accessories for AKe, AK Compact, AKi Compact			162-167



Integrated air ventilation elements



Prevention of condensate water in preservation of protection class IP65

Metric knock-outs



A number of knock-outs enable **variable cable entries**

Three-point installation

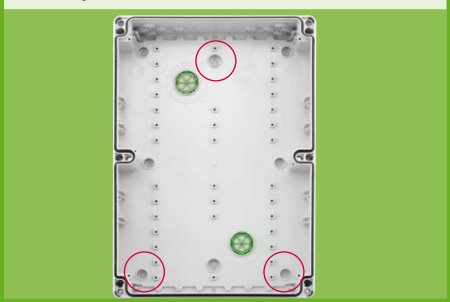

Easy installation via keyhole mounting

Cable cover mounting



Follow-up installation of optional cable cover possible



Height-adjustable mounting rail

For serial installation devices sizes 1 to 3 and special designs



Labelling for installation dimensions

Engraved dimensions simplify installation



Optional exterior installation

Installation via **external fixing lugs**

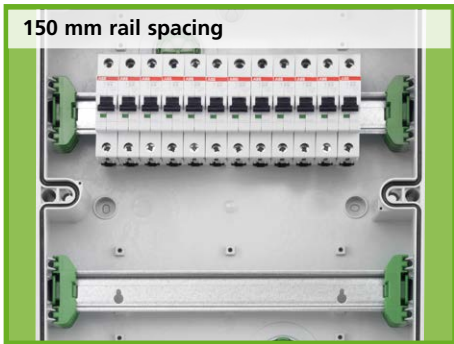

150 mm rail spacing

Offers plenty of space for wiring



Combinable

Easily lateral combination via optional **M50 combination connectors**



Lateral knock-outs M40/M50

Option for Schuko sockets



Optimised hinged window

With ergonomically shaped grips for simple opening and replacement of door end stop



New installation option

Installation outside of sealing area suitable for systems featuring a maximum measured insulation voltage of 1,000V AC / 1,500V DC



Lid able to be lead-sealed

Protects against unauthorised access

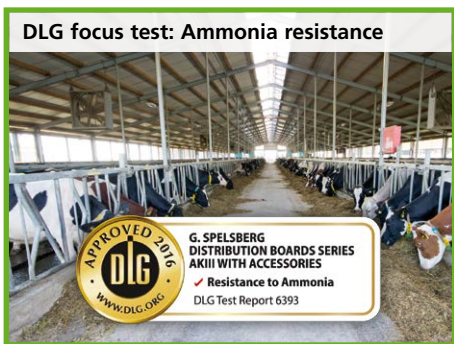

DLG focus test: Ammonia resistance

Resistance against stable air for minimum 20 years



Indoor and outdoor installation

One distribution board for every application



Free of halogen, PVC and silicone

Highly flame-retardant

IP65
14/70
IK08
[Square Icon]
400V AC¹
1000V AC²
1500V DC²
[DVE Icon]
[DLG Icon]
[AIR Icon]
[halogen-free Icon]
[iQ Icon]

1 = acc. DIN EN 60670-24 2 = acc. DIN EN 61439-2

AK 14

315 x 300 x 155 mm



Front side
top/bottom entries:
1 x M32/M40
4 x M20/M25
15 x M20
2 x M16
Entries on each side:
2 x M40/M50
1 x M20
Rear entries:
2 x M32/M40
4 x M20/M25

Description

Order no.

Small-scale distributors - Industrial Quality -, 1-row, 14 distribution units, integrated ventilation elements to reduce the formation of condensate water, elastic entries on top, masking and labelling strips, additional double-membrane seals and other accessories



AK 14

screwless PE/N terminal rails each with 3 screwable clamping points, Clamping units 2.5 - 16 mm², 14 screwless type clamping units 1.5 - 4 mm²

733 414 01

315 x 450 x 155 mm



Front side
top/bottom entries:
1 x M32/M40
4 x M20/M25
15 x M20
2 x M16
Entries on each side:
2 x M40/M50
2 x M20/M25
2 x M20
Rear entries:
2 x M32/M40
6 x M20/M25

AK 14 Plus

with additional connection space, with 35 mm standard rails, without PE/N terminal rails

733 614 01



AK 28

315 x 450 x 155 mm



Front side
top/bottom entries:
1 x M32/M40
4 x M20/M25
15 x M20
2 x M16
Entries on each side:
2 x M40/M50
2 x M20/M25
2 x M20
Rear entries:
2 x M32/M40
6 x M20/M25

Small-scale distributors - Industrial Quality -, 2-row, 28 distribution units, 150 mm rail spacing, integrated ventilation elements to reduce the formation of condensate water, elastic entries on top, masking and labelling strips, additional double-membrane seals and other accessories



AK 28

Screwless PE/N terminal rail, each with 6 screw-type clamping units 2.5 - 16 mm², 21 / 2 x 14 screwless clamping points 1.5 mm² - 4 mm²

733 428 01

315 x 600 x 155 mm



Front side
top/bottom entries:
1 x M32/M40
4 x M20/M25
15 x M20
2 x M16
Entries on each side:
2 x M40/M50
4 x M20/M25
3 x M20
Rear entries:
2 x M32/M40
8 x M20/M25

AK 28 Plus

with additional connection space, with 35 mm standard rails, without PE/N terminal rails

733 628 01



AK 42

315 x 600 x 155 mm



Front side
top/bottom entries:
1 x M32/M40
4 x M20/M25
15 x M20
2 x M16
Entries on each side:
2 x M40/M50
4 x M20/M25
3 x M20
Rear entries:
2 x M32/M40
8 x M20/M25

Description

Order no.

Small-scale distributors - Industrial Quality -, 3-row, 42 distribution units, 150 mm rail spacing, integrated ventilation elements to reduce the formation of condensate water, elastic entries on top, masking and labelling strips, additional double-membrane seals and other accessories



AK 42

Screwless PE/N terminal rail, each with 6 screw-type clamping units 2.5 - 16 mm², 21 / 2 x 14 screwless clamping points 1.5 mm² - 4 mm²

733 442 01

315 x 750 x 155 mm



Front side
top/bottom entries:
1 x M32/M40
4 x M20/M25
15 x M20
2 x M16
Entries on each side:
2 x M40/M50
6 x M20/M25
4 x M20
Rear entries:
2 x M32/M40
10 x M20/M25

AK 42 Plus

with additional connection space, with 35 mm standard rails, without PE/N terminal rails

733 642 01



G. SPELSBERG
DISTRIBUTION BOARDS SERIES
AKIII WITH ACCESSORIES
✓ Resistance to Ammonia
DLG Test Report 6393

AK 56

315 x 750 x 155 mm



Front side
top/bottom entries:
1 x M32/M40
4 x M20/M25
15 x M20
2 x M16
Entries on each side:
2 x M40/M50
6 x M20/M25
4 x M20
Rear entries:
2 x M32/M40
10 x M20/M25

Description

Order no.

Small-scale distributors - **Industrial Quality** -, 4-row, 56 distribution units, 150 mm rail spacing, integrated ventilation elements to reduce the formation of condensate water, screwless PE/N terminal rails each with 6 screwable clamping points, 2.5 - 16 mm², 21 / 2 x 14 screwless clamping points 1.5 mm² - 4 mm², elastic entries on top, masking and labelling strips, additional double membrane seals and further accessories

IP65



IK08



400V
AC



AK 56

733 456 01



G. SPELSBERG
DISTRIBUTION BOARDS SERIES
AKIII WITH ACCESSORIES
✓ Resistance to Ammonia
DLG Test Report 6393

AK 70

315 x 1.050 x 155 mm



Entries top end:
1 x M32/M40
4 x M20/M25
15 x M20
2 x M16
Entries bottom end:
Flange
1 x M40/M50
2 x M32/M40
2 x M20
Entries on each side:
4 x M40/50
6 x M20/M25
5 x M20
Rear entries:
4 x M32/M40,
14 x M20/25

Small-scale distributors - **Industrial Quality** -, comprised of 2 individual housings, 70 distribution units, 150 mm rail spacing, integrated ventilation elements to reduce the formation of condensate water, screwless PE/N terminal rails each with 6 screwable clamping points, 2.5 - 16 mm², 21 / 2 x 14 screwless clamping points 1.5 mm² - 4 mm², elastic entries on top, masking and labelling strips, additional double-membrane seals and other accessories

IP65



IK08



400V
AC



AK 70

733 470 01



G. SPELSBERG
DISTRIBUTION BOARDS SERIES
AKIII WITH ACCESSORIES
✓ Resistance to Ammonia
DLG Test Report 6393

AK-F 14

315 x 300 x 155 mm



Flange type

Face open,
Number of entries
depending on
flange type
Entries on each
side:
2 x M40/50
1 x M20
Rear entries:
2 x M32/40
4 x M20/25

315 x 450 x 155 mm



Face open,
Number of
entries depending
on flange type
Entries on each
side:
2 x M40/50
2 x M20/25
2 x M20
Rear entries:
2 x M32/40
6 x M20/25

Description

Order no.

Small-scale distributors - **Industrial Quality, Flange type**, with open front sides, for the use with various flanges, for the combination of several AK-F distributors via combination flange, 1-row, 14 distribution units, integrated ventilation elements to reduce the formation of condensate water, masking and labelling strips, additional double-membrane seals and other accessories, flange and flange set must be purchased separately



AK-F 14

Screwless PE/N terminal rail, each with 3 screw-type clamping units 2.5 - 16 mm², 14 screwless type clamping units 1.5 - 4 mm²

733 514 01

AK-F 14 Plus

with additional connection space, with 35 mm standard rails, without PE/N terminal rails

733 714 01

Required accessories:

Extension flange and combination flange, see page 152



Distribution boards

AK-F 28

315 x 450 x 155 mm



Flange type

Face open,
Number of entries
depending on
flange type
Entries on each
side:
2 x M40/50
2 x M20/25
2 x M20
Rear entries:
2 x M32/40
6 x M20/25

315 x 600 x 155 mm



Face open,
Number of
entries depending
on flange type
Entries on each
side:
2 x M40/50
4 x M20/25
3 x M20
Rear entries:
2 x M32/40
8 x M20/25

Small-scale distributors - **Industrial Quality, Flange type**, with open front sides, for the use with various flanges, for the combination of several AK-F distributors via combination flange, 2-row, 28 distribution units, 150 mm rail spacing, integrated ventilation elements to reduce the formation of condensate water, masking and labelling strips, additional double-membrane seals and other accessories, flange and flange set must be purchased separately



AK-F 28

Screwless PE/N terminal rail, each with 6 screw-type clamping units 2.5 - 16 mm², 21 / 2 x 14 screwless clamping points 1.5 mm² - 4 mm²

733 528 01

AK-F 28 Plus

with additional connection space, with 35 mm standard rails, without PE/N terminal rails

733 728 01

Required accessories:

Extension flange and combination flange, see page 152



AK-F 42

315 x 600 x 155 mm

Flange type



Face open,
Number of entries
depending on
flange type
Entries on each
side:
2 x M40/50
4 x M20/25
3 x M20
Rear entries:
2 x M32/40
8 x M20/25

315 x 750 x 155 mm



Face open,
Number of entries
depending on
flange type
Entries on each
side:
2 x M40/50
6 x M20/25
4 x M20
Rear entries:
2 x M32/40
10 x M20/25

Description

Order no.

Small-scale distributors - **Industrial Quality, Flange type**, with open front sides, for the use with various flanges, for the combination of several AK-F distributors via combination flange, 3-row, 42 distribution units, 150 mm rail spacing, integrated ventilation elements to reduce the formation of condensate water, masking and labelling strips, additional double-membrane seals and other accessories, flange and flange set must be purchased separately



AK-F 42

Screwless PE/N terminal rail, each with 6 screw-type clamping units 2.5 - 16 mm², 21 / 2 x 14 screwless clamping points 1.5 mm² - 4 mm²

733 542 01

AK-F 42 Plus

with additional connection space, with 35 mm standard rails, without PE/N terminal rails

733 742 01

Required accessories:

Extension flange and combination flange, see page 152



G. SPELSBERG
DISTRIBUTION BOARDS SERIES
AKIII WITH ACCESSORIES
✓ Resistance to Ammonia
DLG Test Report 6393

AK-F 56

315 x 750 x 155 mm

Flange type



Face open,
Number of entries
depending on
flange type
Entries on each
side:
2 x M40/50
6 x M20/25
4 x M20
Rear entries:
2 x M32/40
10 x M20/25

Small-scale distributors - **Industrial Quality, Flange type**, with open front sides, for the use with various flanges, for the combination of several AK-F distributors via combination flange, 4-row, 56 distribution units, 150 mm rail spacing, integrated ventilation elements to reduce the formation of condensate water, screwless PE/N terminal rails each with 6 screwable clamping points, 2.5 - 16 mm², 21 / 2 x 14 screwless clamping points 1.5 mm² - 4 mm², masking and labelling strips, additional double-membrane seals and other accessories, flange and flange set must be purchased separately



AK-F 56

733 556 01

Required accessories:

Extension flange and combination flange, see page 152



G. SPELSBERG
DISTRIBUTION BOARDS SERIES
AKIII WITH ACCESSORIES
✓ Resistance to Ammonia
DLG Test Report 6393



AK 14 L

315 x 300 x 147 mm



Front side
top/bottom entries:
1 x M32/M40
4 x M20/M25
15 x M20
2 x M16
Entries on each side:
2 x M40/M50
1 x M20
Rear entries:
2 x M32/M40
4 x M20/M25



Description

Order no.

Expansion enclosure / empty enclosure - industrial quality, for small distribution boards AK 14-56, for individual expansion with standard rails or mounting plates, integrated ventilation elements to reduce the formation of condensate water, for installation of rail-mounted devices as per DIN 43880 model size 1-3, $U_N=400\text{ V}$, $U_i=1.000\text{V AC} / 1.500\text{V DC}$, $I_N=125\text{A}$



AK 14 L-g
with grey cover

733 410 01

AK 14 L-t
with transparent cover

733 411 01



G. SPELSBERG
INSTALLATIONS-KLEINVERTEILER
SERIE AK III MIT ZUBEHÖR
✓ Ammoniakbeständigkeit
DLG-Prüfbericht 6393

AK-F 14 L

315 x 300 x 147 mm

Flange type



Front side open
Number of entries depending on flange type
Entries on each side:
2 x M40/M50
1 x M20
Rear entries:
2 x M32/M40
4 x M20/M25



Description

Order no.

Expansion enclosure / empty enclosure - industrial quality, for small distribution boards AK-F 14-56, for individual expansion with standard rails or mounting plates, integrated ventilation elements to reduce the formation of condensate water, for installation of rail-mounted devices as per DIN 43880 model size 1-3, $U_n=400\text{ V}$, $U_i=1.000\text{V AC} / 1.500\text{V DC}$, $I_n=125\text{A}$



AK-F 14 L-g
with grey cover

733 510 01

AK-F 14 L-t
with transparent cover

733 511 01



G. SPELSBERG
DISTRIBUTION BOARDS SERIES
AKIII WITH ACCESSORIES
✓ Resistance to Ammonia
DLG Test Report 6393

AK-F/DMS 14 L
315 x 300 x 147 mm

Flange type



- Entries top end:
2 x M16
15 x M20
4 x M20/M25
1 x M32/M40
- Entries bottom end:**
Number of entries
depending on flange
type
- Entries on each side:
2 x M40/M50
1 x M20
- Rear entries:
2 x M32/M40
4 x M20/M25



Description

Order no.

Expansion enclosure / empty enclosure - industrial quality, for small distribution boards AK-F 14-56, for individual expansion with standard rails or mounting plates, integrated ventilation elements to reduce the formation of condensate water, for installation of rail-mounted devices as per DIN 43880 model size 1-3, $U_n=400\text{ V}$, $U_i=1.000\text{ V AC} / 1.500\text{ V DC}$, $I_n=125\text{ A}$



AK-F/DMS 14 L-g with grey cover, with additional double membrane seals	733 310 01
AK-F/DMS 14 L-t with transparent cover, with additional double membrane seals	733 311 01



G. SPELSBERG
DISTRIBUTION BOARDS SERIES
AKIII WITH ACCESSORIES
✓ Resistance to Ammonia
DLG Test Report 6393

Distribution boards

AK3 KS M50



Description

Order no.

IP65

Combination cable glands M50 for the lateral connection of housings AK/AK-F 14/28/42/56/70, as well as Plus types

AK3 KS M50

733 830 01

AK3 FL



IP65

Enclosure wall including flange connector for sealing the face of AK-F enclosures

AK3 FL00
without pre-embossings

733 820 01

AK3 FL01
with pre-embossings: 1 x M50/M40, 2 x M40/32, 2 x M20

733 821 01

AK3 FL02
with pre-embossings: 5 x M25/M20, 4 x M20, 2 x M16

733 822 01

AK3 FL13
with insert via double membrane seals DMS M32 and opening for flange types FL13 as per standard SEN 28 09 01

733 828 01

AK3 KFL

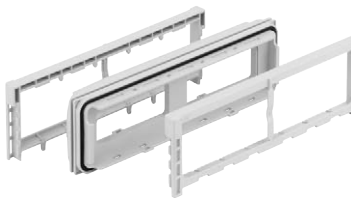

IP65

Combination flange incl. flange connector for the front connection of AK-F housings

AK3 KFL

733 829 01

AK3 KBL



Cable cover for the attachment to AK/AK-F 14/28/42/56/70 housings, as well as Plus types, Can be retroactively mounted on the end

AK3 KBL

733 831 01

AK3 STD



Schuko® mounting socket 16 A, IP54, for the lateral assembly on housings AK/AK-F 14/28/42/56/70, as well as Plus types

AK3 STD

733 834 01

AK3 TW

Description

Order no.

divider made of plastic, suitable for the interior subdivision of AK/AK-F 14/28/42/56 housings, as well as Plus types, with pre-embossing for the cable bushing

AK3 TW

733 832 01

Mounting plate insulating material

Mounting plate made from insulating material, incl. fixing screws

AK3 MPI 14 L

for AK 14 L addition and empty enclosure

733 838 01

AK3 MPI

With opening for AIR ventilation element, for Plus range

733 835 01

AK3 AS

IP65



External hinge set

AK3 AS

only for AK 14 L - addition and empty enclosure

733 837 01

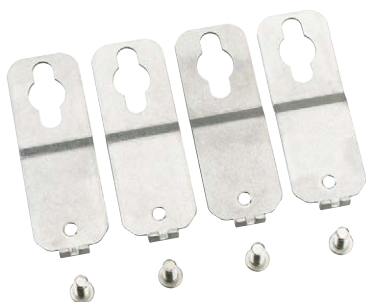
AK3 ABL-ES

Stainless steel external fixing lugs, suitable for enclosure AK/AK-F 14/28/42/56/70, as well as Plus types, 1 set = 4 pcs.

AK3 ABL-ES

733 833 01

AK3 NS35

Standard rail as profile rail 35 x 7.5 mm

AK3 NS35-14

for 14 TE, Incl. profile rail mount for all AK/AK-F 14/28/42/56/70, as well as Plus types

733 812 01

AK3 NS35-275

Length 275 mm, Incl. universal floor fixing mounts for all AK/AK-F 14/28/42/56/70, as well as Plus types and AKi empty enclosures

733 813 01

AK3 KF

AK3 hinged window as a replacement part for all AK/AK-F 14/28/42/56, as well as Plus types, Incl. hinge and handle

AK3 KF

733 801 01



- Individual transparent doors can be lead sealed, blanking off of individual rows

- ▶ Including PE/N terminals
- ▶ Including stepped nipples for cable entry



Distribution boards AKe

AKe 03

100 x 150 x 96 mm



Pre-embossing:
top end:
3 x M20
Entries bottom end:
2 x M20/M25
Entries on each
side:
2 x M20
Entries on floor:
1 x M20

Description

Order no.

Small-scale distributors, 1-row, masking and labelling strips, insulating seals, additional stepped nipples

IP55



IK07



400V
AC



AKe 03
PE/N terminal 2x4-pole, 6/16 mm²

735 503 01

AKe 03-L
Without PE/N terminals

735 603 01

AKe 05

125 x 200 x 122 mm



Pre-embossing:
Top/bottom end:
4 x M20
1 x M20/M25
Entries on each
side:
2 x M20
Entries on floor:
1 x M20

Small-scale distributors, 1-row, masking and labelling strips, insulating seals, additional stepped nipples

IP55



IK07



400V
AC



AKe 05
PE/N terminal 2x5-pole, 6/16 mm²

735 505 01

AKe 05-L
Without PE/N terminals

735 605 01

AKe 09

200 x 200 x 122 mm



Pre-embossing:
Top/bottom end:
8 x M20
1 x M25/M32
Entries on each
side:
2 x M20
Entries on floor:
1 x M20/M25

Small-scale distributors, 1-row, masking and labelling strips, insulating seals, additional stepped nipples

IP55



IK07



400V
AC



AKe 09
PE/N terminal 2x7-pole, 6/16 mm²

735 509 01

AKe 09-L
Without PE/N terminals

735 609 01

AKe 12

250 x 200 x 122 mm



Pre-embossing:
Top/bottom end:
8 x M20
2 x M20/M25
1 x M32/M40
Entries on each side:
2 x M20
Entries on floor:
2 x M20/M25

Description

Order no.

Small-scale distributors, 1-row, masking and labelling strips, insulating seals, additional stepped nipples



AKe 12
PE/N terminal 2x12-pole, 6/16 mm²

735 512 01

AKe 12-L
Without PE/N terminals

735 612 01

AKe 24

250 x 370 x 122 mm



Pre-embossing:
Top/bottom end:
8 x M20
2 x M20/M25
1 x M32/M40
Entries on each side:
8 x M20
2 x M32/M40
Entries on floor:
2 x M20/M25

Small-scale distributors, 2-row, 150 mm rail spacing, masking and labelling strips, insulating seals, additional stepped nipples



AKe 24
PE/N terminal 2 x 16-pole, 6/16 mm²

735 724 01

AKe 24-L
Without PE/N terminals

735 824 01

AKe 36

300 x 600 x 142 mm



Pre-embossing:
top end:
17 x M20
2 x M20/M25
1 x M32/M40
Entries on each side:
16 x M20
4 x M25/M32
Entries bottom end:
15 x M20
2 x M20/M25
1 x M32/M40

Small-scale distributors, 3-row, 150 mm rail spacing, masking and labelling strips, insulating seals, additional stepped nipples



AKe 36
PE/N terminal 2 x 25-pole, 6/16/25 mm²

735 536 01

AKe 36-L
Without PE/N terminals

735 636 01

AKe 48

300 x 750 x 142 mm



Pre-embossing:

top end:

17 x M20

2 x M20/M25

1 x M32/M40

Entries on each side:

20 x M20

5 x M20/M25

Entries bottom end:

15 x M20

2 x M20/M25

1 x M32/M40

Description

Order no.

Small-scale distributors, 4-row, 150 mm rail spacing, masking and labelling strips, insulating seals, additional stepped nipples

IP55



IK07



400V
AC



AKe 48

PE/N terminal 2 x 25-pole, 6/16/25 mm²

735 548 01

AKe 48-L

Without PE/N terminals

735 648 01

Distribution boards



- Quick installation thanks to patented sealing membranes
- Special designs on request

- Cylinder lock can be installed later
- Simple combination options



Industrial Quality



Distribution boards AK / AKi Compact

AK 03

100 x 150 x 96 mm



Entries top end:
3 x M20
Entries bottom end:
2 x M20/M25
Entries on each side:
2 x M20
Entries on floor:
1 x M20

Description

Order no.

Small-scale distributors, 3 distribution units, PE/N terminal, with each 1 clamping point 16 mm², 3 clamping points 6 mm², 3 elastic entries on top, masking and labelling strips, insulating seals, additional double-membrane seals

**AK 03**

735 403 01

AK 05

125 x 200 x 122 mm



Entries end:
4 x M20
1 x M20/M25
Entries on each side:
2 x M20
Entries on floor:
1 x M20

Small-scale distributors, 5 distribution units, PE/N terminal, with each 2 clamping points 16 mm², 3 clamping points 6 mm², 4 elastic entries on top, masking and labelling strips, insulating seals, additional double-membrane seals

**AK 05**

735 405 01

AK 09

200 x 200 x 122 mm



Entries end:
8 x M20
1 x M25/M32
Entries on each side:
2 x M20
Entries on floor:
2 x M20/M25

Small-scale distributors, 9 distribution units, PE/N terminal, with each 2 clamping points 16 mm², 5 clamping points 6 mm², 6 elastic entries on top, masking and labelling strips, insulating seals, additional double-membrane seals

**AK 09**

735 409 01

AK 12

250 x 200 x 122 mm



Entries end:
8 x M20
2 x M20/M25
1 x M32/M40
Entries on each side:
2 x M20
Entries on floor:
2 x M20/M25

Small-scale distributors, 12 distribution units, PE/N terminal, with each 2 clamping points 16 mm², 10 clamping points 6 mm², 8 elastic entries on top, masking and labelling strips, insulating seals, additional double-membrane seals

**AK 12**

735 412 01

AK 24

250 x 370 x 122 mm



Entries end:
8 x M20
2 x M20/M25
1 x M32/M40
Entries on each side:
8 x M20
2 x M32/M40
Entries on floor:
4 x M20/M25

Small-scale distributors, 24 distribution units, PE/N terminal, with each 2 clamping points 16 mm², 14 clamping points 6 mm², 8 elastic entries on top, masking and labelling strips, insulating seals, additional double-membrane seals

**AK 24**

735 424 01

AKi 03

100 x 150 x 96 mm



Entries top end:
3 x M20
Entries bottom end:
2 x M20/M25
Entries on each side:
2 x M20
Entries on floor:
1 x M20

Description

Order no.

Small-scale distributors - Industrial Quality -, 3 distribution units, PE/N terminal, with each 1 clamping point 16 mm², 3 clamping points 6 mm², 3 elastic entries on top, masking and labelling strips, insulating seals, additional double-membrane seals



AKi 03

736 403 01

AKi 05

125 x 200 x 122 mm



Entries end:
4 x M20
1 x M20/M25
Entries on each side:
2 x M20
Entries on floor:
1 x M20

Small-scale distributors - Industrial Quality -, 5 distribution units, PE/N terminal, with each 2 clamping points 16 mm², 3 clamping points 6 mm², 4 elastic entries on top, masking and labelling strips, insulating seals, additional double-membrane seals



AKi 05

736 405 01

AKi 09

200 x 200 x 122 mm



Entries end:
8 x M20
1 x M25/M32
Entries on each side:
2 x M20
Entries on floor:
2 x M20/M25

Small-scale distributors - Industrial Quality -, 9 distribution units, PE/N terminal, with each 2 clamping points 16 mm², 5 clamping points 6 mm², 6 elastic entries on top, masking and labelling strips, insulating seals, additional double-membrane seals



AKi 09

736 409 01

AKi 12

250 x 200 x 122 mm



Entries end:
8 x M20
2 x M20/M25
1 x M32/M40
Entries on each side:
2 x M20
Entries on floor:
2 x M20/M25

Description

Order no.

Small-scale distributors - Industrial Quality -, 12 distribution units, PE/N terminal, with each 2 clamping points 16 mm², 10 clamping points 6 mm², 8 elastic entries on top, masking and labelling strips, insulating seals, additional double-membrane seals

IP65



IK08



400V
AC



AKi 12

736 412 01

AKi 24

250 x 370 x 122 mm



Entries end:
8 x M20
2 x M20/M25
1 x M32/M40
Entries on each side:
8 x M20
2 x M32/M40
Entries on floor:
4 x M20/M25

Small-scale distributors - Industrial Quality -, 24 distribution units, PE/N terminal, with each 2 clamping points 16 mm², 14 clamping points 6 mm², 8 elastic entries on top, masking and labelling strips, insulating seals, additional double-membrane seals

IP65



IK08



400V
AC



AKi 24

736 424 01

AK combi set

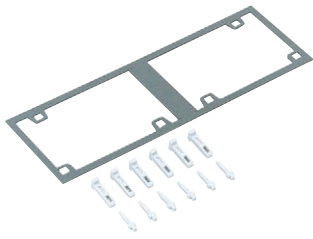

Description

Order no.

IP65

Combi set, for horizontal or vertical combination of all AK enclosures for 300 mm width, complete with wedge connectors and intermediate sealing for 150 and 300 mm enclosure sides, each 300 mm = 1 combi set

AK KS-IP65

791 001 01

AK combi set



IP30

Combi set without intermediate enclosure seal, for horizontal or vertical combination of all AK enclosures for 300 mm width, 1 set = 10 wedge connectors

AK KS-IP30

591 100 01

Combi connector



IP54

Combi connector, for connecting enclosures, thermoplastic

KST M32

f. wall thicknesses/mm
1,5 - 4,0

193 032 01

Combi set



IP66

Combi set, for side connection of enclosures with metric entries, complete with lock nuts and intermediate wall seal inserts

KS M20
KS M25
KS M25-gro
KS M32

f. wall thicknesses/mm Thread length/mm

2 x 3,0
2 x 3,0
2,0 x 8,0
2 x 3,5

12
12
22
14

192 020 01
192 025 01
192 026 01
192 032 01

Double membrane seals



IP66

Double membrane seals made of elastic plastic with two sealing membranes, closed

DMS M16
DMS M20
DMS M25
DMS M32

f. wall thicknesses/mm Sealing area/mm

1.5 - 4.5
1.5 - 4.5
1.5 - 4.5
1.5 - 4.5

5 - 9
7 - 12
9 - 16
14 - 21

260 416 01
260 420 01
260 425 01
260 432 01

Cable gland



IP68

Description

Order no.

Cable gland with strain relief, Polyamide, M_ x 1.5 mm, with lock nut

	Thread length/mm	Sealing area/mm	
KVR M12-MGM	8	2 - 6.5	227 412 01
KVR M16-MGM	8	4 - 10.0	227 416 01
KVR M20-MGM	9	6 - 12.0	227 420 01
KVR M20-GDB/MGM	9	7 - 14.0	227 421 01
KVR M25-MGM	11	9 - 16	227 425 01
KVR M32-MGM	11	11 - 21.0	227 432 01
KVR M40-MGM	11	16 - 28.0	227 440 01
KVR M50-MGM	13	21 - 34.5	227 450 01
KVR M63-MGM	17	30 - 44.5	227 463 01

Ventilation seal



IP44

With ventilation seal to avoid condensation formation in enclosures, flow rate 100 l/min. at 0.1 bar overpressure, thermoplastic elastomer, grey, recommended for insertion on the left and right enclosure sides in different heights (see Technical Appendix - Protection against condensate water)

	f. wall thicknesses/mm	
BST M20	1,5 - 4,5	262 420 01

AK Mounting flange



Enclosure wall, for installation in the components of the AK enclosure system for 300 mm wide end walls, with cable covers as standard

AK ABF 1 with pre-embossing, 2 x M32 / M40 / M50, 1 x M40 / M50 / M63	795 048 01
AK ABF 2 Smooth for self-drilling	795 050 01

AKi Mounting flange



Enclosure wall, for attachment to components of AKi enclosure system to 300 mm wide sides, with cable covers as standard

AKi ABF 1 with pre-embossing, 2 x M32 / M40 / M50, 1 x M40 / M50 / M63	796 051 01
AKi ABF 2 Smooth for self-drilling	796 050 01

Lock fittings



Lock fittings, for installation in hinged doors of distribution boxes AK 03 to AK/AKi 70 and AK/AKi Plus 14 to 56, with 2 keys and installation instructions

AK SGA-1 Identical locks	706 102 01
AK SGA-2 Different closures, max. 10 different closures possible	706 902 01

Lock bolt set



Description

Order no.

Lock bolt set, for installation in AKe 36 to 48, in conjunction with the lock fittings 706 102 01 / 706 902 01 several hinged windows can be safely locked by only one single lock.

AK SRS

706 104 01

Partition wall



Partition wall, for installation in the components of the AK enclosure system, from AKe 36/48, universal application for various enclosure heights, with break-out openings, grey

AK TW

797 910 01

Cable cover

300 x 125 x 90 mm



for installation in the components of the AK enclosure system for 300 mm wide end walls, with cable covers as standard

AK KBL

792 400 01

Masking off strips



Masking off strips, to close off unused circuit-breaker positions, detachable, grey

AK AS

Width 108 mm for 6 distribution units

799 012 01

AK AS-v

Width 216 mm for 12 distribution units, lockable

799 013 01

Bord Case



On-board case, for closing off unused circuit breaker positions, width 54 mm for 3 distribution units, for 35 mm standard rail, e.g. to house fuses, operating instructions, etc.

AK BC

799 103 01

Standard rail NS 35



Description

Order no.

Standard rail acc. to DIN EN 60715, 35 x 7.5, width 35 mm

AK NS35-250

from 300 x 300 mm, length 250 mm, including spacers

562 735 01

NS35-216/3

universal floor fixing, length 216 mm, with fixing screws

795 030 01

AK External attachment set



External fixing lugs, for mounting separate enclosures or small units on flat wall surfaces, can be fixed to the box base at an angle of 0°, 45°, or 90°, wall gap 7 mm, material stainless steel, suitable for all AK enclosures from 300 mm front,

AK ABL-ES

Set = 4 pcs.

793 004 01

Z-wall profile



Z-wall profile, length 2 m, with 8 M6 cylinder screws and 8 captive push nuts, wall clearance 70 mm, Material: galvanised steel

ZPR

070 800 01

KF 12 hinged window

228 x 80 mm



IP65

Hinged window, for fitting to enclosure cover, for maximum 12 distribution units à 17.5 mm, with transparent hinged window, frame with sealing on both sides, with drilling template and fixing screws

KF 12

567 412 01

SF 12 inspection window

228 x 80 mm



IP65

Inspection window, for fitting to enclosure cover, transparent inspection glass, with drilling template and fixing screws

SF 12

568 012 01

PE/N terminal block

PE/N terminal block for mounting onto 35 mm standard rail, e.g. in meter housings

KLS N 35 N terminal (blue) 3 x 25 mm ² , 2 x 16 mm ²	790 905 01
KLS PE 35 PE terminal (green) 3 x 25 mm ² , 2 x 16 mm ²	790 805 01

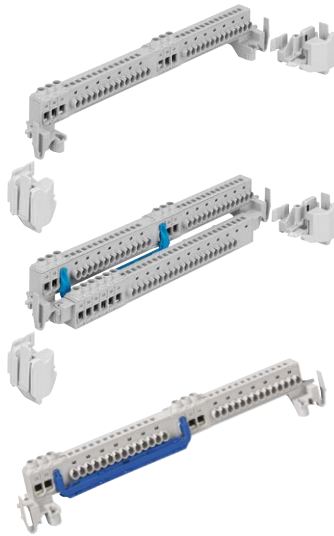
PE/N screwless terminal rail

PE/N screwless terminal, for installation in AK/AKi small-scale distributors from AK/AKi 14, as additional terminals or for replacement

AK 14 PEN-SL Single-stage PE/N terminal rail with each, 3 screwable clamping points, 2.5 mm ² - 16 mm ² and , 14 screwless terminal points , 1.5 - 4 mm ²	790 317 01
AK 28 PEN-SL Two-row PE/N terminal rail each with, 6 screwable clamping points, 2.5 mm ² - 16 mm ² and , 21 / 2 x 14 screwless clamping points 1.5 mm ² - 4 mm ²	790 327 01
AK N-SL Single-stage N terminal rail, with 4 screwable clamping points 2.5 mm ² - 16 mm ² , and 28 screwless clamping points 1.5 mm ² - 4 mm ² , Following removal of the cross-connection, distribution into, 2 N potentials each with 3 screwable terminal points, 2.5 mm ² - 16 mm ² and 14 screwless, Terminal points 1.5 mm ² - 4 mm ²	790 318 01

PE/N terminal rail

PE/N terminal rail, for installation in AK/AKi small-scale distributors as additional terminals or for replacement

	Number of pole	Clamping range	
AK 03 PEN-S	2 x 4-pole	1x16 / 3x6 mm ²	790 204 01
AK 05 PEN-S	2 x 5-pole	2x16 / 3x6 mm ²	790 205 01
AK 09 PEN-S	2 x 7-pole	2x16 / 5x6 mm ²	790 207 01
AK 12 PEN-S	2 x 12-pole	2x16 / 10x6 mm ²	790 211 01
AK 24 PEN-S	2 x 16-pole	2x16 / 14x6 mm ²	790 218 01
AK 14/28 PEN-S	2 x 17-pole	1x25 / 4x16 / 12x6 mm ²	790 217 01
AK 42 PEN-S	2 x 25-pole	1x25 / 6x16 / 18x6 mm ²	790 225 01

4-way neutral conductor terminal



Auxiliary terminal, for subsequent attachment to AK PE/N basic terminals from AK 14

AK N 47-S

4 x 7-pole,, with each 2 clamping points 16 mm², 5 clamping points 6 mm²

790 047 01

1-way neutral conductor terminal



Auxiliary terminal, for subsequent attachment to AK PE/N-S basic terminals from AK 42

AK N 17-S

1 x 7-pole,, with each 2 clamping points 16 mm², 5 clamping points 6 mm²

790 007 01



STV-L

Empty, without fittings but with PE/N terminal

- High mechanical strength
- Insensitive to temperature
- Compact dimensions
- Uses quality sockets
- Can be combined

- ▶ The housing can also be combined horizontally with AKi Kompakt small distributors.
- ▶ The special knockout contour allows other components to be installed, such as switch disconnectors.

STV empty enclosures

Description

Order no.

Socket casing - industrial quality, empty enclosure, prepared for the installation of Schuko- and CEE- sockets, with PE/N clip, masking and labelling strips, insulating seals, additional double-membrane seals

IP44



STV 502-L



STV 504-L



STV 512-L



STV 904-L



STV 912-L



STV 922-L



STV 923-L



STV 1208-L



STV 1222-L



STV 1224-L

STV 502-L

125 x 200 x 122 mm, 4 TE

728 902 01

STV 504-L

125 x 400 x 122 mm, 5 TE

728 904 01

STV 512-L

125 x 400 x 122 mm, 5 TE

728 912 01

STV 904-L

200 x 200 x 122 mm, 8 TE

729 904 01

STV 912-L

200 x 400 x 122 mm, 9 TE

729 912 01

STV 922-L

200 x 400 x 122 mm, 9 TE

729 922 01

STV 923-L

200 x 400 x 122 mm, 9 TE

729 923 01

STV 1208-L

250 x 400 x 122 mm, 12 TE

731 908 01

STV 1222-L

250 x 400 x 122 mm, 12 TE

731 922 01

STV 1224-L

250 x 400 x 122 mm, 12 TE

731 924 01

Empty socket
distribution boxes

STV KS combi set

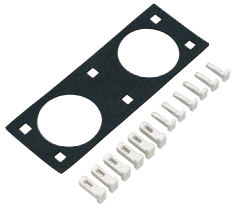

Description

Order no.

IP65

For horizontal combination with AKi 05/09 small distributors, complete with wedge connectors and intermediate seals

STV KS-IP 65

791 002 01

Double membrane seals



IP66

Double membrane seals made of elastic plastic with two sealing membranes, closed

f. wall thicknesses/mm Sealing area/mm

DMS M16	1.5 - 4.5	5 - 9	260 416 01
DMS M20	1.5 - 4.5	7 - 12	260 420 01
DMS M25	1.5 - 4.5	9 - 16	260 425 01
DMS M32	1.5 - 4.5	14 - 21	260 432 01
DMS M40	1.5 - 4.5	19 - 28	260 440 01

Cable gland



IP68

Cable gland with strain relief, polyamide, M_ x 1.5 mm, with lock nut

Thread length/mm Sealing area/mm

KVR M12-MGM	8	2 - 6.5	227 412 01
KVR M16-MGM	8	4 - 10.0	227 416 01
KVR M20-MGM	9	6 - 12.0	227 420 01
KVR M20-GDB/MGM	9	7 - 14.0	227 421 01
KVR M25-MGM	11	9 - 16	227 425 01
KVR M32-MGM	11	11 - 21.0	227 432 01
KVR M40-MGM	11	16 - 28.0	227 440 01
KVR M50-MGM	13	21 - 34.5	227 450 01
KVR M63-MGM	17	30 - 44.5	227 463 01

KD BD blank cover



Blank cleat for empty enclosures, for closing off unused socket openings

KD BD/CEE

510 060 01

KD BD/Schuko®

510 038 01

Handle



Description

Order no.

Handle made of plastic, for mobile use of housing, screw spacing 120 mm

TG 2	with self-cutting screws	191 805 01
TG 1	with screws M6 and nuts made of plastic	191 800 01

Supply line



Supply line kit for socket combinations up to 16 A, 2 m cable HO7RN-F 5G2.5

NAL 2 m-S16	with CEE connector 16 A, 5-pole	500 025 01
--------------------	---------------------------------	------------

Supply line



Supply line kit for socket combinations up to 32 A, 2 m cable HO7RN-F 5G4

NAL 2 m-S32	with CEE connector 16 A, 5-pole	500 040 01
--------------------	---------------------------------	------------

Combi set



IP66

Combi set, for side connection of enclosures with metric entries, complete with lock nuts and intermediate wall seal inserts

	f. wall thicknesses/mm	Thread length/mm	
KS M20	2 x 3,0	12	192 020 01
KS M25	2 x 3,0	12	192 025 01
KS M25-gro	2,0 x 8,0	22	192 026 01
KS M32	2 x 3,5	14	192 032 01

AKi WSD

400 x 580 x 270 mm



Stainless steel, for external housing applications from AKi series up to 300 x 450 mm

AKi WSD	793 100 01
----------------	------------

Empty socket
distribution boxes

Double membrane seals



IP66

Description

Order no.

Double membrane seals made of elastic plastic with two sealing membranes, closed

	f. wall thicknesses/mm	Sealing area/mm	
DMS M16	1.5 - 4.5	5 - 9	260 416 01
DMS M20	1.5 - 4.5	7 - 12	260 420 01
DMS M25	1.5 - 4.5	9 - 16	260 425 01
DMS M32	1.5 - 4.5	14 - 21	260 432 01
DMS M40	1.5 - 4.5	19 - 28	260 440 01

Cable gland



IP68

Cable gland with strain relief, polyamide, M_ x 1.5 mm, with lock nut

	Thread length/mm	Sealing area/mm	
KVR M12-MGM	8	2 - 6.5	227 412 01
KVR M16-MGM	8	4 - 10.0	227 416 01
KVR M20-MGM	9	6 - 12.0	227 420 01
KVR M20-GDB/MGM	9	7 - 14.0	227 421 01
KVR M25-MGM	11	9 - 16	227 425 01
KVR M32-MGM	11	11 - 21.0	227 432 01
KVR M40-MGM	11	16 - 28.0	227 440 01
KVR M50-MGM	13	21 - 34.5	227 450 01
KVR M63-MGM	17	30 - 44.5	227 463 01

Ventilation seal



IP44

With ventilation seal to avoid condensation formation in enclosures, flow rate 100 l/min. at 0.1 bar overpressure, thermoplastic elastomer, grey, recommended for insertion on the left and right enclosure sides in different heights (see Technical Appendix - protection against condensate water)

	f. wall thicknesses/mm	Color	
BST M20	1,5 - 4,5	Grey	262 420 01
BST M20/sw	1,5 - 4,5	black	262 020 01

Cable cover

300 x 125 x 90 mm



for installation in the components of the AK enclosure system for 300 mm wide end walls, with cable covers as standard

AK KBL 792 400 01

Bord Case



Description

Order no.

On-board case, for closing off unused circuit breaker positions, width 54 mm for 3 distribution units, for 35 mm standard rail, e.g. to house fuses, operating instructions, etc.

AK BC

799 103 01

Lock fittings



Lock fittings, for installation in hinged doors of distribution boxes AK 03 to AK/AKi 70 and AK/AKi Plus 14 to 56, with 2 keys and installation instructions

AK SGA-1

Identical locks

706 102 01

AK SGA-2

Different closures, max. 10 different closures possible

706 902 01

AK External attachment set



External fixing lugs, for mounting separate enclosures or small units on flat wall surfaces, can be fixed to the box base at an angle of 0°, 45°, or 90°, wall gap 7 mm, material stainless steel, suitable for all AK enclosures from 300 mm front,

AK ABL-ES

Set = 4 pcs.

793 004 01

Z-wall profile



Z-wall profile, length 2 m, with 8 M6 cylinder screws and 8 captive push nuts, wall clearance 70 mm, material: galvanised steel

ZPR

070 800 01



The empty enclosures from Spelsberg offer a wide variety of housing sizes and materials. However, should you not find exactly what you are looking for among the many variations of standard products, we would be pleased to design a product with you that is tailored precisely to your needs. Take advantage of the space available for this customisation.

Empty enclosures

	Protection rating	Size	Types	Page
	IP66	65 x 65 mm to 361 x 254 mm	Empty enclosures made of polystyrene TK PS	176-194
	IP66	50 x 52 mm to 361 x 254 mm	Empty enclosures made of polycarbonate TK PC	176-194
	IP66 NEW!	89 x 89 mm to 388 x 270 mm	Aluminium empty enclosures TK AL	195-197
	IP66 / IP67	84 x 82 mm to 302 x 232 mm	Empty enclosures made of ABS TG ABS	204-221
	IP66 / IP67	84 x 82 mm to 302 x 232 mm	Empty enclosures made of polycarbonate TG PC	204-221
	IP65	150 x 300 mm to 300 x 600 mm	Combinable empty enclosures made of polystyrene AKL	224-229
	IP65	150 x 300 mm to 300 x 600 mm	Combinable empty enclosures made of polycarbonate AKi-L	224-229
	IP66	50 x 45 mm to 330 x 230 mm	Aluminium empty enclosures AL	234-235
	Accessories for TK			198-202
	Accessories for TG			222-223
	Accessories for AKL/AKi-L			230-233
	Accessories for AL			236
	General accessories for empty enclosures			237
	IP65 /IP54	---	Automatic machine enclosures, empty enclosures SVi A, SVi L	238-241

Empty enclosures TK PC

- ▷ Ammonia resistance
- ▷ Resistance against stable air for minimum 20 years

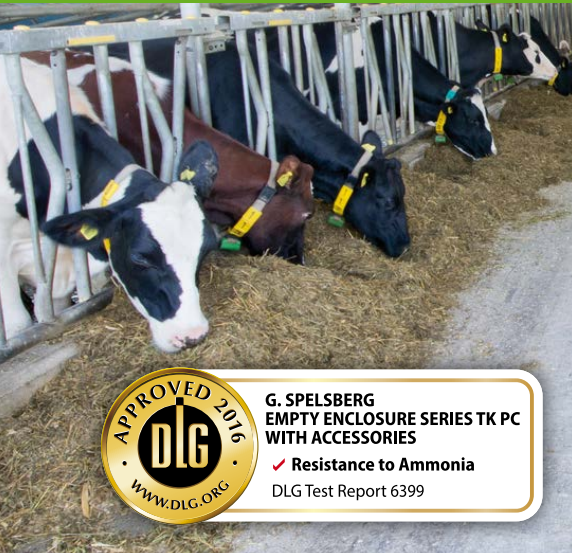

G. SPELSBERG
EMPTY ENCLOSURE SERIES TK PC
WITH ACCESSORIES
✓ Resistance to Ammonia
DLG Test Report 6399



- 14 basic enclosures with up to three different cover heights
- Grey or transparent covers
- Plastic: choice of polystyrene (TK PS) or glass-fibre-reinforced polycarbonate (TK PC)
- Side walls smooth or with metric knockouts
- Modular tools: Economical customisation

Example of TK designation scheme



Empty enclosures TK PS / TK PC



- 8 aluminium enclosures
- Powder-coated for corrosion protection
- Colour: light grey, similar to RAL 7035
- Material: Aluminium die-cast
- Effective protection against electromagnetic interference (EMI) and electrostatic discharge (ESD)
- Internal dimensions similar to TK PS / TK PC, mounting plates and standard rails likewise compatible

IP66

IK09



Empty enclosures TK AL

TK 55

52 x 50 mm



Base and cover: **Polycarbonate**, grey, similar to RAL 7035

Enclosure type	Height	Order No.
TK PC 55-4-m	35	127 455 01
TK PC 55-4-o	35	120 455 01

Base and cover: **Polycarbonate**, grey, similar to RAL 7035

Enclosure type	Height	Order No.
TK PC 55-4-v	35	129 455 01
sealing area/mm: 5-10		

Base: **Polycarbonate**, grey, similar to RAL 7035
Cover: **Polycarbonate**, transparent



Enclosure type	Height	Order No.
TK PC 55-4-tm	35	137 455 01
TK PC 55-4-to	35	130 455 01

Base: **Polycarbonate**, grey, similar to RAL 7035
Cover: **Polycarbonate**, transparent

Enclosure type	Height	Order No.
TK PC 55-4-tv	35	139 455 01
Dichtber./mm: 5-10		

TK 75

65 x 50 mm



Base and cover **Polycarbonate**, grey, similar to RAL 7035

Enclosure type	Height	Order No.
TK PC 75-4-m	35	127 475 01
TK PC 75-4-o	35	120 475 01

Base and cover: **Polycarbonate**, grey, similar to RAL 7035

Enclosure type	Height	Order No.
TK PC 75-4-v	35	129 475 01
TK PC 75-4-2v	35	128 475 01
sealing area/mm: 5-10		

Base: **Polycarbonate**, grey, similar to RAL 7035
Cover: **Polycarbonate**, transparent



Enclosure type	Height	Order No.
TK PC 75-4-tm	35	137 475 01
TK PC 75-4-to	35	130 475 01

Base: **Polycarbonate**, grey, similar to RAL 7035
Cover: **Polycarbonate**, transparent

Enclosure type	Height	Order No.
TK PC 75-4-tv	35	139 475 01
TK PC 75-4-2tv	35	138 475 01
sealing area/mm: 5-10		

TK 77

65 x 65 mm



Base and cover: **Polystyrene**, grey, similar to RAL 7035

Enclosure type	Height	Order No.
TK PS 77-6-m	57	105 401 01
TK PS 77-8-m	81	105 901 01
TK PS 77-6-o	57	110 401 01
TK PS 77-8-o	81	110 901 01

Base and cover: **Polycarbonate**, grey, similar to RAL 7035

Enclosure type	Height	Order No.
TK PC 77-6-m	57	127 401 01
TK PC 77-8-m	81	127 901 01

Base: **Polystyrene**, grey, similar to RAL 7035
Cover: **Polycarbonate**, transparent



Enclosure type	Height	Order No.
TK PS 77-6-tm	57	106 001 01
TK PS 77-8-tm	81	106 501 01
TK PS 77-6-to	57	111 001 01
TK PS 77-8-to	81	111 501 01

Base: **Polycarbonate**, grey, similar to RAL 7035
Cover: **Polycarbonate**, transparent

Enclosure type	Height	Order No.
TK PC 77-6-tm	57	137 001 01
TK PC 77-8-tm	81	137 501 01

also available in aluminium, see page 196

With knockouts

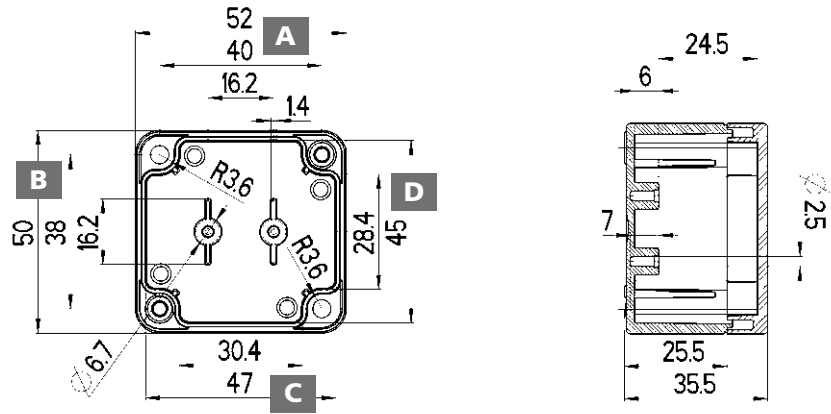
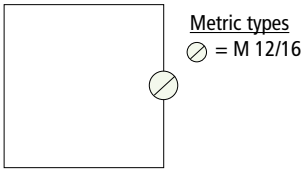

Without knockouts

Maximum possible through openings per box side

M	12	16	20	25	32	40	50
A/C	1	1	-	-	-	-	-
B/D	1	1	-	-	-	-	-

With knockouts

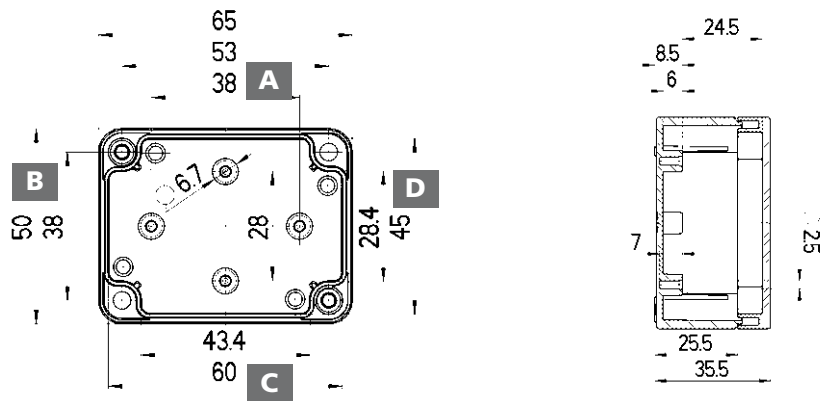
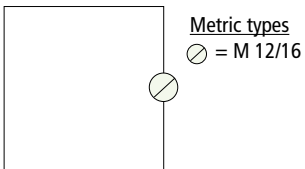

Without knockouts

Maximum possible through openings per box side

M	12	16	20	25	32	40	50
A/C	2	1	-	-	-	-	-
B/D	1	1	-	-	-	-	-

With knockouts

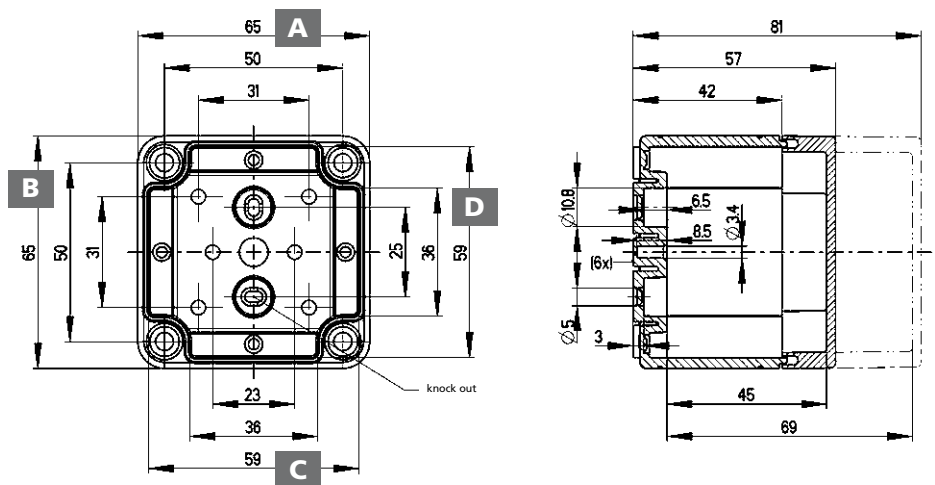
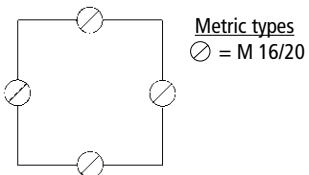

Without knockouts

Maximum possible through openings per box side

M	12	16	20	25	32	40	50
A/C	2	1	1	-	-	-	-
B/D	2	1	1	-	-	-	-

TK 97

94 x 65 mm



Base and cover: **Polystyrene**, grey, similar to RAL 7035

Enclosure type	Height	Order No.
TK PS 97-6-m	57	105 402 01
TK PS 97-8-m	81	105 902 01
TK PS 97-6-o	57	110 402 01
TK PS 97-8-o	81	110 902 01

Base and cover: **Polycarbonate**, grey, similar to RAL 7035

Enclosure type	Height	Order No.
TK PC 97-6-m	57	127 402 01
TK PC 97-8-m	81	127 902 01

Base: **Polystyrene**, grey, similar to RAL 7035
Cover: **Polycarbonate**, transparent



Enclosure type	Height	Order No.
TK PS 97-6-tm	57	106 002 01
TK PS 97-8-tm	81	106 502 01
TK PS 97-6-to	57	111 002 01
TK PS 97-8-to	81	111 502 01

Base: **Polycarbonate**, grey, similar to RAL 7035
Cover: **Polycarbonate**, transparent

Enclosure type	Height	Order No.
TK PC 97-6-tm	57	137 002 01
TK PC 97-8-tm	81	137 502 01

TK 99

94 x 94 mm



Base and cover: **Polystyrene**, grey, similar to RAL 7035

Enclosure type	Height	Order No.
TK PS 99-6-m	57	105 403 01
TK PS 99-8-m	81	105 903 01
TK PS 99-6-o	57	110 403 01
TK PS 99-8-o	81	110 903 01

Base and cover: **Polycarbonate**, grey, similar to RAL 7035

Enclosure type	Height	Order No.
TK PC 99-6-m	57	127 403 01
TK PC 99-8-m	81	127 903 01

Base: **Polystyrene**, grey, similar to RAL 7035
Cover: **Polycarbonate**, transparent



Enclosure type	Height	Order No.
TK PS 99-6-tm	57	106 003 01
TK PS 99-8-tm	81	106 503 01
TK PS 99-6-to	57	111 003 01
TK PS 99-8-to	81	111 503 01

Base: **Polycarbonate**, grey, similar to RAL 7035
Cover: **Polycarbonate**, transparent

Enclosure type	Height	Order No.
TK PC 99-6-tm	57	137 003 01
TK PC 99-8-tm	81	137 503 01

also available in aluminium, see page 196

With knockouts

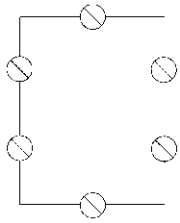

Metric types
 Ⓞ = M 16/20

Without knockouts

Maximum possible through openings per box side

M	12	16	20	25	32	40	50
A/C	2	1	1	1	-	-	-
B/D	3	2	2	1	-	-	-

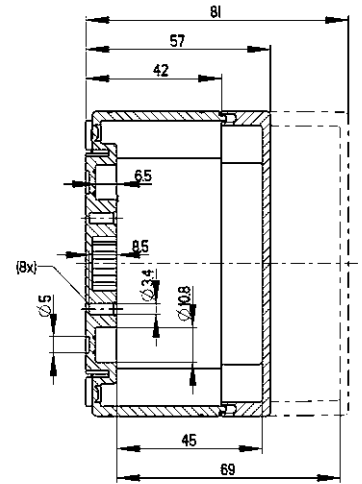
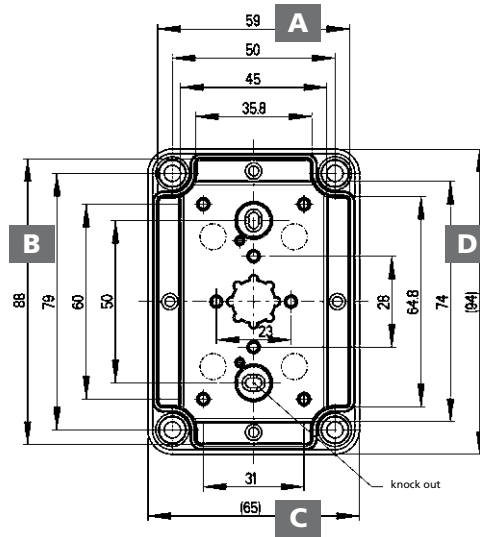

With knockouts

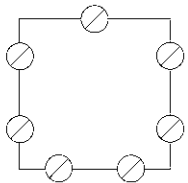

Metric types
 Ⓞ = M 16/20

Without knockouts

Maximum possible through openings per box side

M	12	16	20	25	32	40	50
A/C	3	2	2	-	-	-	-
B/D	3	2	2	-	-	-	-

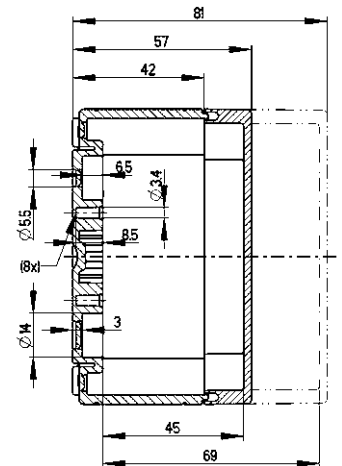
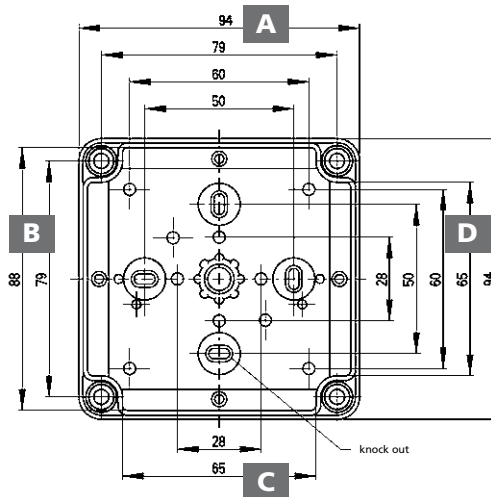

Empty enclosures

TK 1005

100 x 52 mm



NEW!

Base and cover: **Polycarbonate**, grey, similar to RAL 7035

Enclosure type	Height	Order No.
TK PC 1005-4-m	37	127 480 01
TK PC 1005-4-o	37	120 480 01

Base: **Polycarbonate**, grey, similar to RAL 7035
Cover: **Polycarbonate**, transparent



NEW!

Enclosure type	Height	Order No.
TK PC 1005-4-tm	37	137 480 01
TK PC 1005-4-to	37	130 480 01

TK 1111

110 x 110 mm



Base and cover: **Polystyrene**, grey, similar to RAL 7035

Enclosure type	Height	Order No.
TK PS 1111-7-m	66	105 404 01
TK PS 1111-9-m	90	105 904 01
TK PS 1111-7-o	66	110 404 01
TK PS 1111-9-o	90	110 904 01

Base and cover: **Polycarbonate**, grey, similar to RAL 7035

Enclosure type	Height	Order No.
TK PC 1111-7-m	66	127 404 01
TK PC 1111-9-m	90	127 904 01

Base: **Polystyrene**, grey, similar to RAL 7035
Cover: **Polycarbonate**, transparent



Enclosure type	Height	Order No.
TK PS 1111-7-tm	66	106 004 01
TK PS 1111-9-tm	90	106 504 01
TK PS 1111-7-to	66	111 004 01
TK PS 1111-9-to	90	111 504 01

Base: **Polycarbonate**, grey, similar to RAL 7035
Cover: **Polycarbonate**, transparent

Enclosure type	Height	Order No.
TK PC 1111-7-tm	66	137 004 01
TK PC 1111-9-tm	90	137 504 01

also available in aluminium, see page 196

With knockouts



Metric types
 = M 12/16

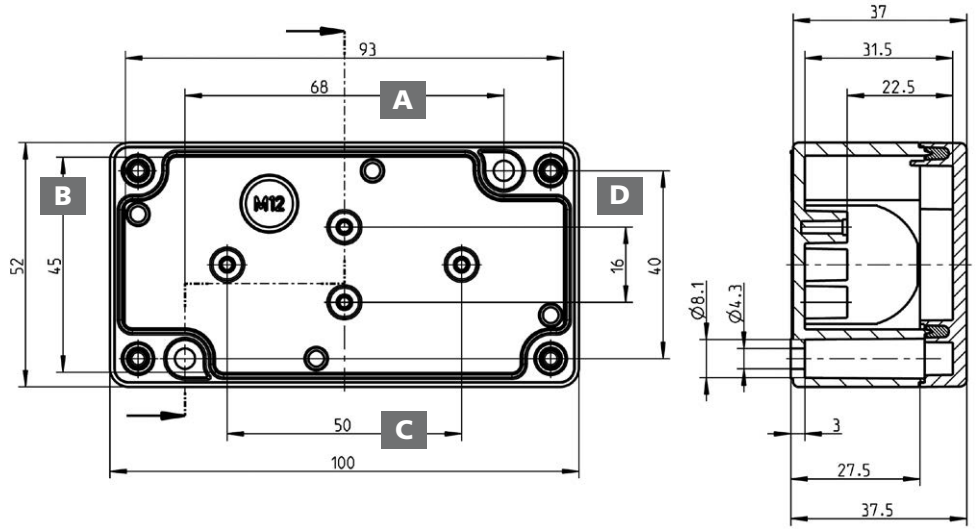

Without knockouts

Maximum possible through openings per box side

M	12	16	20	25	32	40	50
A/C	2	2	-	-	-	-	-
B/D	1	1	-	-	-	-	-

With knockouts

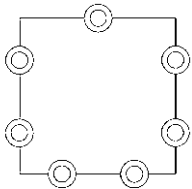

Metric types
 = M 20/25

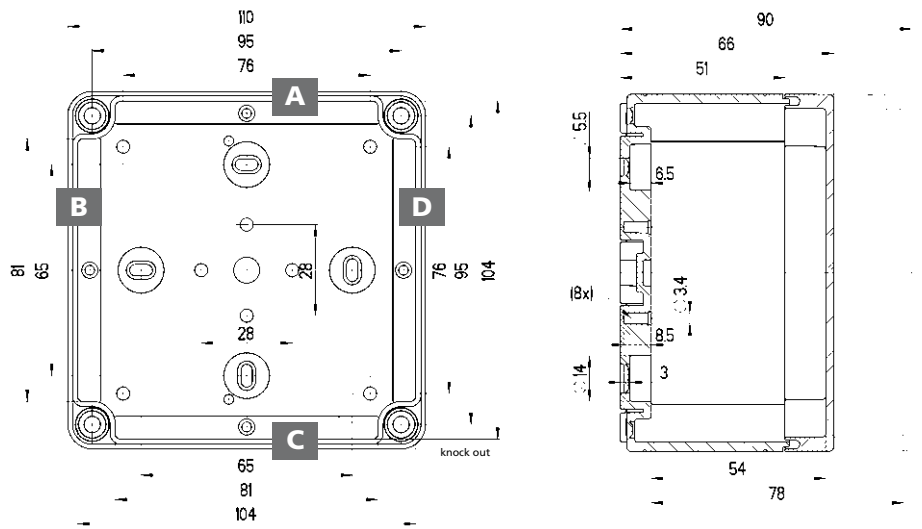

Without knockouts

Maximum possible through openings per box side

M	12	16	20	25	32	40	50
A/C	8	4	2	2	-	-	-
B/D	8	4	2	2	-	-	-

Empty enclosures

TK 1309

130 x 94 mm

Base and cover: **Polystyrene**, grey, similar to RAL 7035Base and cover: **Polycarbonate**, grey, similar to RAL 7035

Enclosure type	Height	Order No.
TK PS 1309-6-m	57	105 409 01
TK PS 1309-8-m	81	105 909 01
TK PS 1309-6-o	57	110 409 01
TK PS 1309-8-o	81	110 909 01

Enclosure type	Height	Order No.
TK PC 1309-6-m	57	127 409 01
TK PC 1309-8-m	81	127 909 01

Base: **Polystyrene**, grey, similar to RAL 7035
Cover: **Polycarbonate**, transparentBase: **Polycarbonate**, grey, similar to RAL 7035
Cover: **Polycarbonate**, transparent

Enclosure type	Height	Order No.
TK PS 1309-6-tm	57	106 009 01
TK PS 1309-8-tm	81	106 509 01
TK PS 1309-6-to	57	111 009 01
TK PS 1309-8-to	81	111 509 01

Enclosure type	Height	Order No.
TK PC 1309-6-tm	57	137 009 01
TK PC 1309-8-tm	81	137 509 01

TK 1313

130 x 130 mm

Base and cover: **Polystyrene**, grey, similar to RAL 7035Base and cover: **Polycarbonate**, grey, similar to RAL 7035

Enclosure type	Height	Order No.
TK PS 1313-7-m	75	105 405 01
TK PS 1313-10-m	99	105 905 01
TK PS 1313-7-o	75	110 405 01
TK PS 1313-10-o	99	110 905 01

Enclosure type	Height	Order No.
TK PC 1313-7-m	75	127 405 01
TK PC 1313-10-m	99	127 905 01

Base: **Polystyrene**, grey, similar to RAL 7035
Cover: **Polycarbonate**, transparentBase: **Polycarbonate**, grey, similar to RAL 7035
Cover: **Polycarbonate**, transparent

Enclosure type	Height	Order No.
TK PS 1313-7-tm	75	106 005 01
TK PS 1313-10-tm	99	106 505 01
TK PS 1313-7-to	75	111 005 01
TK PS 1313-10-to	99	111 505 01

Enclosure type	Height	Order No.
TK PC 1313-7-tm	75	137 005 01
TK PC 1313-10-tm	99	137 505 01

also available in aluminium, see page 196

TK 1809

180 x 94 mm

Base and cover: **Polystyrene**, grey, similar to RAL 7035Base and cover: **Polycarbonate**, grey, similar to RAL 7035

Enclosure type	Height	Order No.
TK PS 1809-6-m	57	105 410 01
TK PS 1809-8-m	81	105 910 01
TK PS 1809-6-o	57	110 410 01
TK PS 1809-8-o	81	110 910 01

Enclosure type	Height	Order No.
TK PC 1809-6-m	57	127 410 01
TK PC 1809-8-m	81	127 910 01

Base: **Polystyrene**, grey, similar to RAL 7035
Cover: **Polycarbonate**, transparentBase: **Polycarbonate**, grey, similar to RAL 7035
Cover: **Polycarbonate**, transparent

Enclosure type	Height	Order No.
TK PS 1809-6-tm	57	106 010 01
TK PS 1809-8-tm	81	106 510 01
TK PS 1809-6-to	57	111 010 01
TK PS 1809-8-to	81	111 510 01

Enclosure type	Height	Order No.
TK PC 1809-6-tm	57	137 010 01
TK PC 1809-8-tm	81	137 510 01

With knockouts

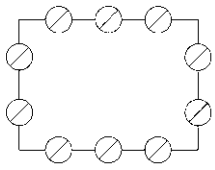

Metric types
 ○ = M 16/20

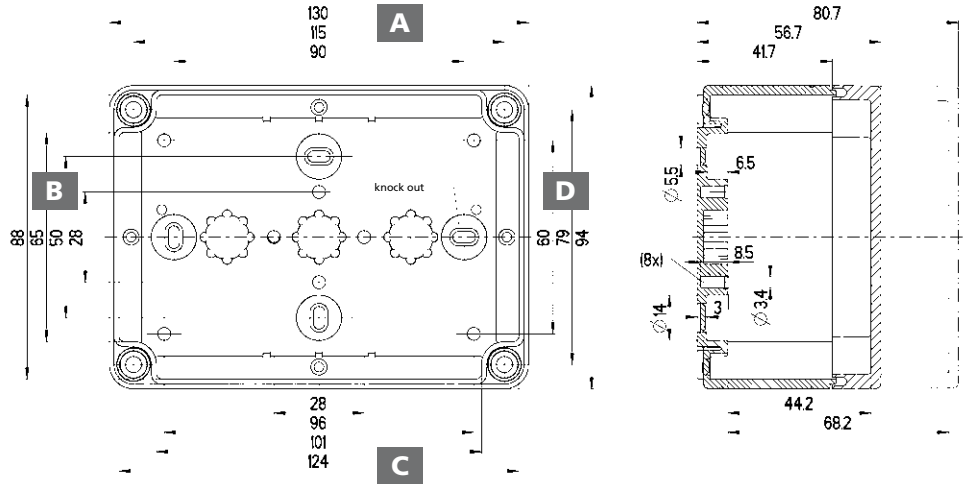

Without knockouts

Maximum possible through openings per box side

M	12	16	20	25	32	40	50
A/C	5	4	3	2	-	-	-
B/D	3	2	2	1	-	-	-

With knockouts

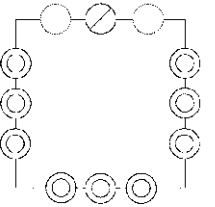

Metric types
 ○ = M 20
 ○ = M 20/25
 ○ = M 25/32

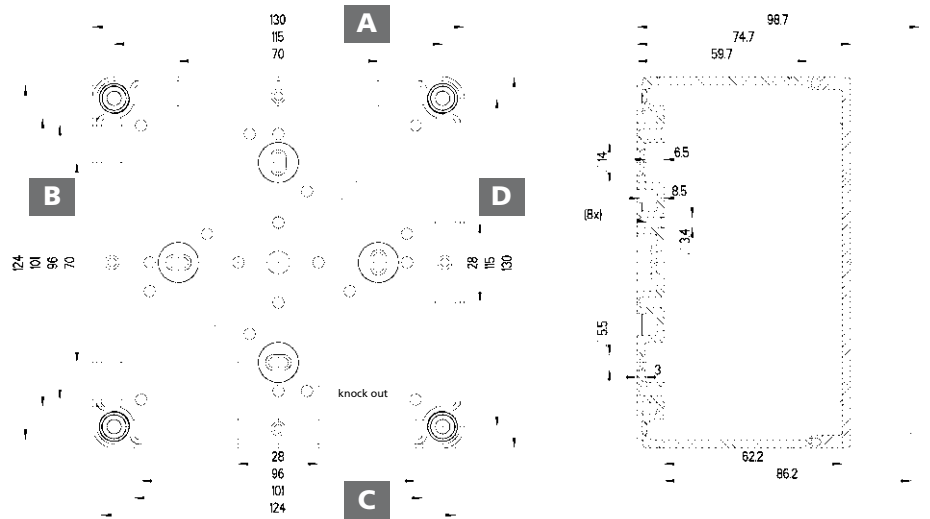

Without knockouts

Maximum possible through openings per box side

M	12	16	20	25	32	40	50
A/C	10	6	3	3	2	-	-
B/D	10	6	3	3	2	-	-

With knockouts

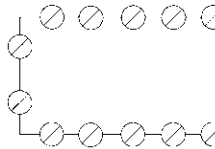

Metric types
 ○ = M 16/20

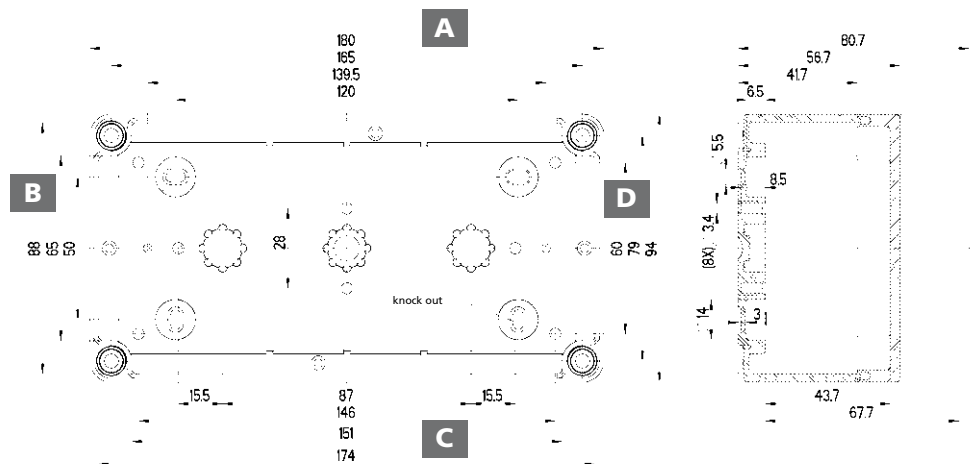

Without knockouts

Maximum possible through openings per box side

M	12	16	20	25	32	40	50
A/C	8	6	5	4	-	-	-
B/D	3	2	2	1	-	-	-

TK 1811

180 x 110 mm

flat



Base and cover: **Polystyrene**, grey, similar to RAL 7035

Enclosure type	Height	Order No.
TK PS 1811-6f-m	63	105 414 01
TK PS 1811-8f-m	84	105 914 01
TK PS 1811-13f-m	137	104 414 01
TK PS 1811-6f-o	63	110 414 01
TK PS 1811-8f-o	84	110 914 01
TK PS 1811-13f-o	137	109 414 01

Base and cover: **Polycarbonate**, grey, similar to RAL 7035

Enclosure type	Height	Order No.
TK PC 1811-6f-m	63	127 414 01
TK PC 1811-8f-m	84	127 914 01
TK PC 1811-13f-m	137	128 414 01

Base: **Polystyrene**, grey, similar to RAL 7035
Cover: **Polycarbonate**, transparent



Enclosure type	Height	Order No.
TK PS 1811-6f-tm	63	106 014 01
TK PS 1811-8f-tm	84	106 514 01
TK PS 1811-13f-tm	137	107 014 01
TK PS 1811-6f-to	63	111 014 01
TK PS 1811-8f-to	84	111 514 01
TK PS 1811-13f-to	137	112 014 01

Base: **Polycarbonate**, grey, similar to RAL 7035
Cover: **Polycarbonate**, transparent

Enclosure type	Height	Order No.
TK PC 1811-6f-tm	63	137 014 01
TK PC 1811-8f-tm	84	137 514 01
TK PC 1811-13f-tm	137	138 014 01

TK 1811

180 x 110 mm



Base and cover: **Polystyrene**, grey, similar to RAL 7035

Enclosure type	Height	Order No.
TK PS 1811-9-m	90	105 406 01
TK PS 1811-11-m	111	105 906 01
TK PS 1811-16-m	165	104 406 01
TK PS 1811-9-o	90	110 406 01
TK PS 1811-11-o	111	110 906 01
TK PS 1811-16-o	165	109 406 01

Base and cover: **Polycarbonate**, grey, similar to RAL 7035

Enclosure type	Height	Order No.
TK PC 1811-9-m	90	127 406 01
TK PC 1811-11-m	111	127 906 01
TK PC 1811-16-m	165	128 406 01

Base: **Polystyrene**, grey, similar to RAL 7035
Cover: **Polycarbonate**, transparent



Enclosure type	Height	Order No.
TK PS 1811-9-tm	90	106 006 01
TK PS 1811-11-tm	111	106 506 01
TK PS 1811-16-tm	165	107 006 01
TK PS 1811-9-to	90	111 006 01
TK PS 1811-11-to	111	111 506 01
TK PS 1811-16-to	165	112 006 01

Base: **Polycarbonate**, grey, similar to RAL 7035
Cover: **Polycarbonate**, transparent

Enclosure type	Height	Order No.
TK PC 1811-9-tm	90	137 006 01
TK PC 1811-11-tm	111	137 506 01
TK PC 1811-16-tm	165	138 006 01

also available in aluminium, see page 197

With knockouts

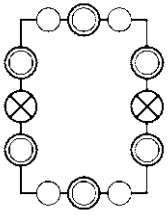

Metric types

- = M 12
- ⊙ = M 16/20
- ⊗ = M 25/32

Without knockouts

Maximum possible through openings per box side

M	12	16	20	25	32	40	50
A/C	4	3	2	2	1	-	-
B/D	8	4	4	3	2	-	-

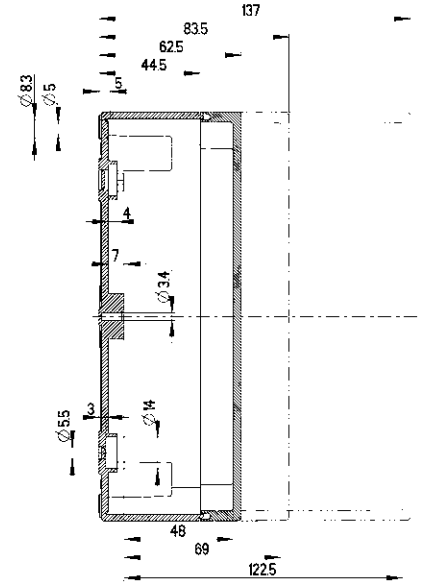
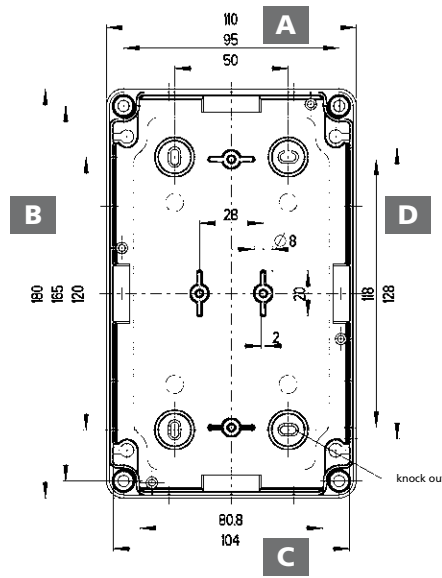

With knockouts

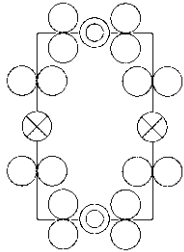

Metric types

- = M 20
- ⊙ = M 20/25
- ⊗ = M 32/40

Without knockouts

Maximum possible through openings per box side

M	12	16	20	25	32	40	50
A/C	12	6	5	3	1	1	1
B/D	20	10	8	5	3	2	1

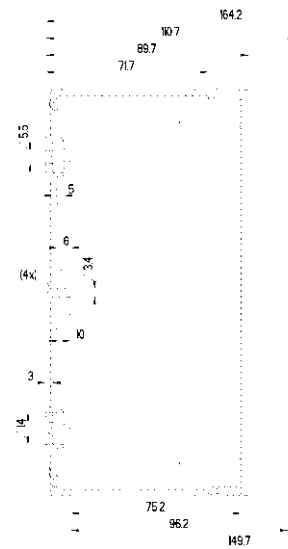
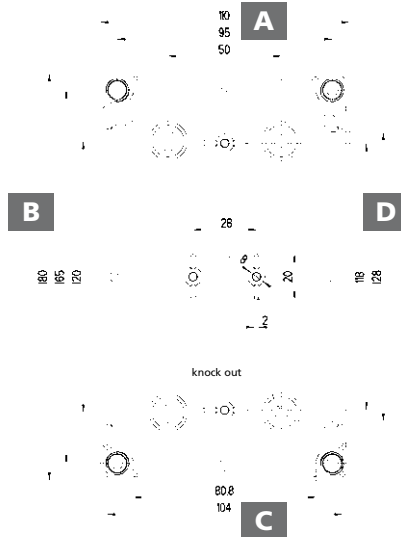

TK 1813

180 x 130 mm

flat

Base and cover: **Polystyrene**, grey, similar to RAL 7035

Base and cover: **Polycarbonate**, grey, similar to RAL 7035



Enclosure type	Height	Order No.
TK PS 1813-6f-m	63	105 415 01
TK PS 1813-8f-m	84	105 915 01
TK PS 1813-13f-m	137	104 415 01
TK PS 1813-6f-o	63	110 415 01
TK PS 1813-8f-o	84	110 915 01
TK PS 1813-13f-o	137	109 415 01

Enclosure type	Height	Order No.
TK PC 1813-8f-m	84	127 915 01
TK PC 1813-6f-m	63	127 415 01
TK PC 1813-13f-m	137	128 415 01

Base: **Polystyrene**, grey, similar to RAL 7035
Cover: **Polycarbonate**, transparent

Base: **Polycarbonate**, grey, similar to RAL 7035
Cover: **Polycarbonate**, transparent



Enclosure type	Height	Order No.
TK PS 1813-6f-tm	63	106 015 01
TK PS 1813-8f-tm	84	106 515 01
TK PS 1813-13f-tm	137	107 015 01
TK PS 1813-8f-to	84	111 515 01
TK PS 1813-13f-to	137	112 015 01
TK PS 1813-6f-to	63	111 015 01

Enclosure type	Height	Order No.
TK PC 1813-6f-tm	63	137 015 01
TK PC 1813-13f-tm	137	138 015 01
TK PC 1813-8f-tm	84	137 515 01

TK 1813

180 x 130 mm

Base and cover: **Polystyrene**, grey, similar to RAL 7035

Base and cover: **Polycarbonate**, grey, similar to RAL 7035



Enclosure type	Height	Order No.
TK PS 1813-9-m	90	105 416 01
TK PS 1813-11-m	111	105 916 01
TK PS 1813-16-m	165	104 416 01
TK PS 1813-9-o	90	110 416 01
TK PS 1813-11-o	111	110 916 01
TK PS 1813-16-o	165	109 416 01

Enclosure type	Height	Order No.
TK PC 1813-9-m	90	127 416 01
TK PC 1813-11-m	111	127 916 01
TK PC 1813-16-m	165	128 416 01

Base: **Polystyrene**, grey, similar to RAL 7035
Cover: **Polycarbonate**, transparent

Base: **Polycarbonate**, grey, similar to RAL 7035
Cover: **Polycarbonate**, transparent



Enclosure type	Height	Order No.
TK PS 1813-9-tm	90	106 016 01
TK PS 1813-11-tm	111	106 516 01
TK PS 1813-16-tm	165	107 016 01
TK PS 1813-9-to	90	111 016 01
TK PS 1813-11-to	111	111 516 01
TK PS 1813-16-to	165	112 016 01

Enclosure type	Height	Order No.
TK PC 1813-9-tm	90	137 016 01
TK PC 1813-11-tm	111	137 516 01
TK PC 1813-16-tm	165	138 016 01

With knockouts

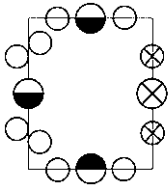

Metric types

- = M 20/25
- ⊗ = M 25/32
- = M 12/16
- ⊘ = M 16/20

Without knockouts

Maximum possible through openings per box side

M	12	16	20	25	32	40	50
A/C	10	4	3	2	1	-	-
B/D	12	5	4	4	1	-	-

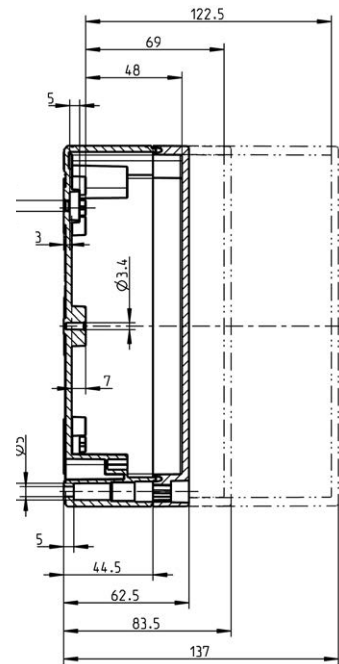
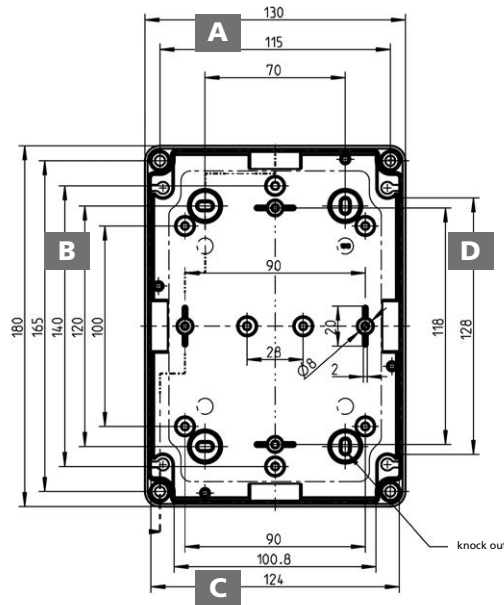

With knockouts

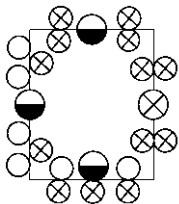

Metric types

- = M 20/25
- ⊗ = M 25/32
- = M 12/16
- ⊘ = M 16/20

Without knockouts

Maximum possible through openings per box side

M	12	16	20	25	32	40	50
A/C	15	8	6	3	2	1	1
B/D	20	10	8	5	3	2	1

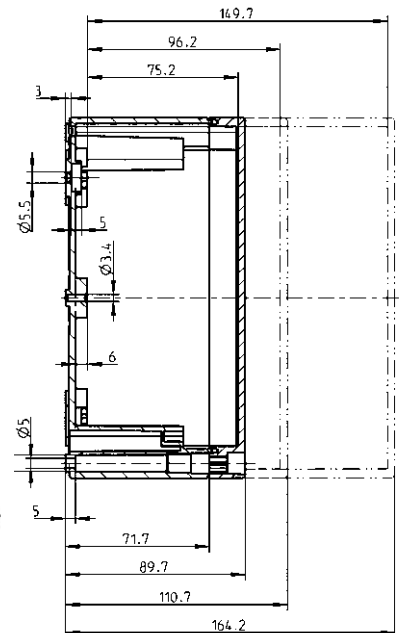
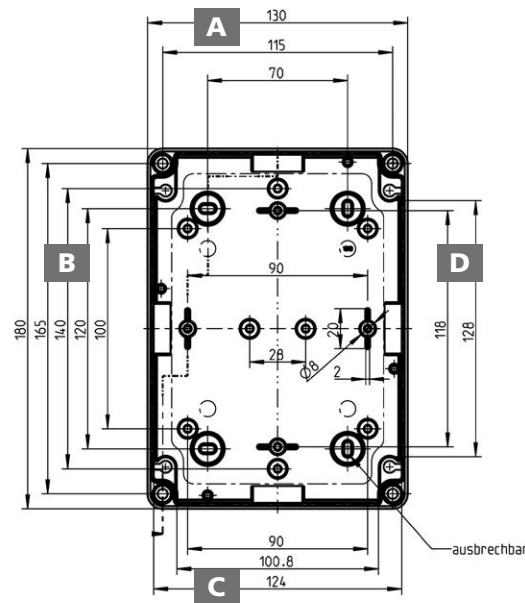

Empty enclosures

TK 1818

182 x 180 mm

flatBase and cover: **Polystyrene**, grey, similar to RAL 7035

Enclosure type	Height	Order No.
TK PS 1818-6f-m	63	105 413 01
TK PS 1818-8f-m	84	105 913 01
TK PS 1818-13f-m	137	104 413 01
TK PS 1818-6f-o	63	110 413 01
TK PS 1818-8f-o	84	110 913 01
TK PS 1818-13f-o	137	109 413 01

Base and cover: **Polycarbonate**, grey, similar to RAL 7035

Enclosure type	Height	Order No.
TK PC 1818-6f-m	63	127 413 01
TK PC 1818-8f-m	84	127 913 01
TK PC 1818-13f-m	137	128 413 01

Base: **Polystyrene**, grey, similar to RAL 7035
Cover: **Polycarbonate**, transparent

Enclosure type	Height	Order No.
TK PS 1818-6f-tm	63	106 013 01
TK PS 1818-8f-tm	84	106 513 01
TK PS 1818-13f-tm	137	107 013 01
TK PS 1818-6f-to	63	111 013 01
TK PS 1818-8f-to	84	111 513 01
TK PS 1818-13f-to	137	112 013 01

Base: **Polycarbonate**, grey, similar to RAL 7035
Cover: **Polycarbonate**, transparent

Enclosure type	Height	Order No.
TK PC 1818-6f-tm	63	137 013 01
TK PC 1818-8f-tm	84	137 513 01
TK PC 1818-13f-tm	137	138 013 01

TK 1818

182 x 180 mm

Base and cover: **Polystyrene**, grey, similar to RAL 7035

Enclosure type	Height	Order No.
TK PS 1818-9-m	90	105 407 01
TK PS 1818-11-m	111	105 907 01
TK PS 1818-16-m	165	104 407 01
TK PS 1818-9-o	90	110 407 01
TK PS 1818-11-o	111	110 907 01
TK PS 1818-16-o	165	109 407 01

Base and cover: **Polycarbonate**, grey, similar to RAL 7035

Enclosure type	Height	Order No.
TK PC 1818-9-m	90	127 407 01
TK PC 1818-11-m	111	127 907 01
TK PC 1818-16-m	165	128 407 01

Base: **Polystyrene**, grey, similar to RAL 7035
Cover: **Polycarbonate**, transparent

Enclosure type	Height	Order No.
TK PS 1818-9-tm	90	106 007 01
TK PS 1818-11-tm	111	106 507 01
TK PS 1818-16-tm	165	107 007 01
TK PS 1818-9-to	90	111 007 01
TK PS 1818-11-to	111	111 507 01
TK PS 1818-16-to	165	112 007 01

Base: **Polycarbonate**, grey, similar to RAL 7035
Cover: **Polycarbonate**, transparent

Enclosure type	Height	Order No.
TK PC 1818-9-tm	90	137 007 01
TK PC 1818-11-tm	111	137 507 01
TK PC 1818-16-tm	165	138 007 01

also available in aluminium, see page 197

With knockouts

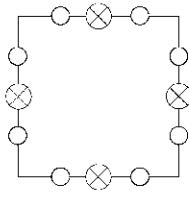

Metric types

○ = M 16/20

⊗ = M 25/32

Without knockouts

Maximum possible through openings per box side

M	12	16	20	25	32	40	50
A/C	12	6	4	3	1	-	-
B/D	12	6	4	3	1	-	-

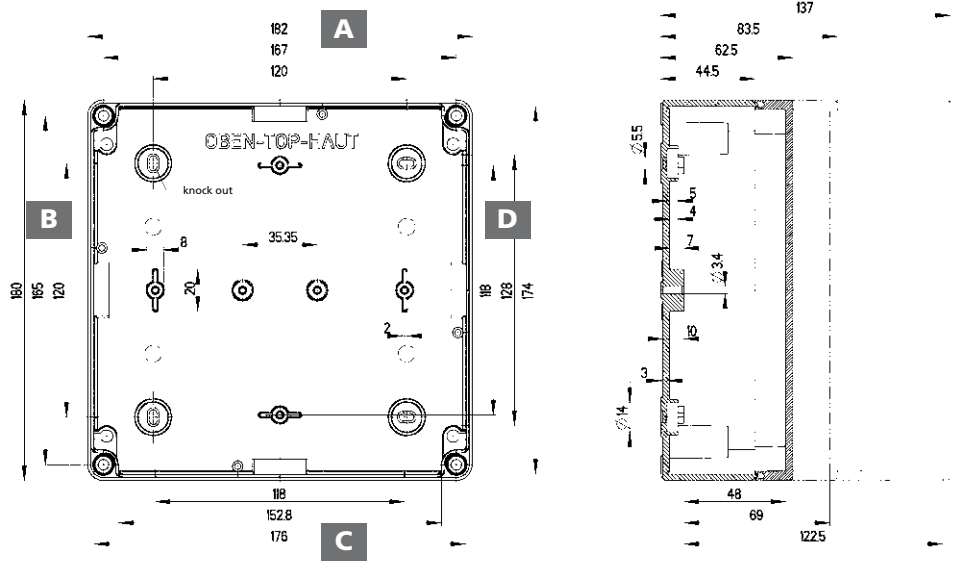

With knockouts

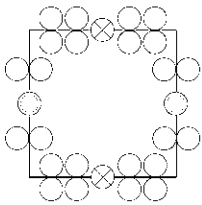

Metric types

○ = M 20

⊗ = M 32/40

⊗ = M 25/32

Without knockouts

Maximum possible through openings per box side

M	12	16	20	25	32	40	50
A/C	23	12	10	5	3	3	2
B/D	20	10	8	5	3	2	1

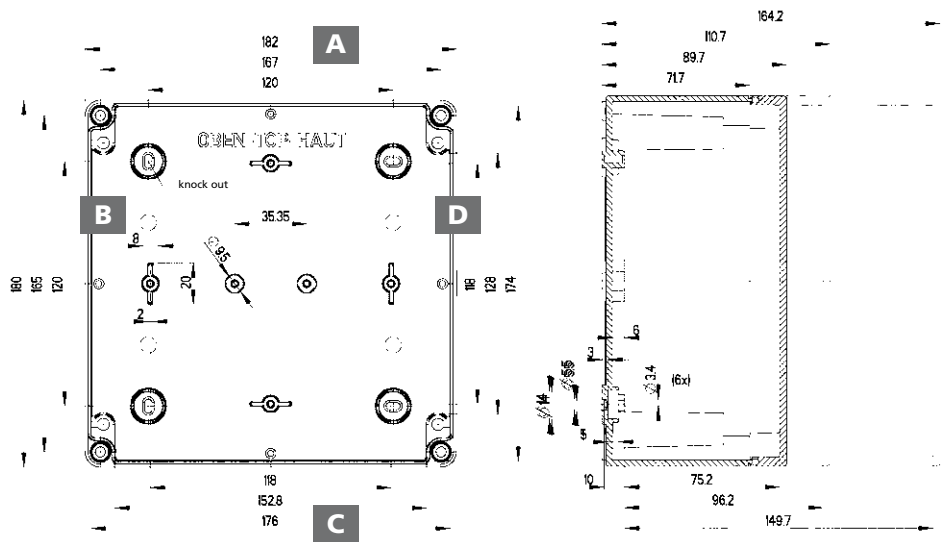

Empty enclosures

TK 2518

254 x 180 mm

flat



Base and cover: **Polystyrene**, grey, similar to RAL 7035

Enclosure type	Height	Order No.
TK PS 2518-6f-m	63	105 411 01
TK PS 2518-8f-m	84	105 911 01
TK PS 2518-13f-m	137	104 411 01
TK PS 2518-6f-o	63	110 411 01
TK PS 2518-8f-o	84	110 911 01
TK PS 2518-13f-o	137	109 411 01

Base and cover: **Polycarbonate**, grey, similar to RAL 7035

Enclosure type	Height	Order No.
TK PC 2518-6f-m	63	127 411 01
TK PC 2518-8f-m	84	127 911 01
TK PC 2518-13f-m	137	128 411 01

Base: **Polystyrene**, grey, similar to RAL 7035
Cover: **Polycarbonate**, transparent



Enclosure type	Height	Order No.
TK PS 2518-6f-tm	63	106 011 01
TK PS 2518-8f-tm	84	106 511 01
TK PS 2518-13f-tm	137	107 011 01
TK PS 2518-6f-to	63	111 011 01
TK PS 2518-8f-to	84	111 511 01
TK PS 2518-13f-to	137	112 011 01

Base: **Polycarbonate**, grey, similar to RAL 7035
Cover: **Polycarbonate**, transparent

Enclosure type	Height	Order No.
TK PC 2518-6f-tm	63	137 011 01
TK PC 2518-8f-tm	84	137 511 01
TK PC 2518-13f-tm	137	138 011 01

TK 2518

254 x 180 mm



Base and cover: **Polystyrene**, grey, similar to RAL 7035

Enclosure type	Height	Order No.
TK PS 2518-9-m	90	105 408 01
TK PS 2518-11-m	111	105 908 01
TK PS 2518-16-m	165	104 408 01
TK PS 2518-9-o	90	110 408 01
TK PS 2518-11-o	111	110 908 01
TK PS 2518-16-o	165	109 408 01

Base and cover: **Polycarbonate**, grey, similar to RAL 7035

Enclosure type	Height	Order No.
TK PC 2518-9-m	90	127 408 01
TK PC 2518-11-m	111	127 908 01
TK PC 2518-16-m	165	128 408 01

Base: **Polystyrene**, grey, similar to RAL 7035
Cover: **Polycarbonate**, transparent



Enclosure type	Height	Order No.
TK PS 2518-9-tm	90	106 008 01
TK PS 2518-11-tm	111	106 508 01
TK PS 2518-16-tm	165	107 008 01
TK PS 2518-9-to	90	111 008 01
TK PS 2518-11-to	111	111 508 01
TK PS 2518-16-to	165	112 008 01

Base: **Polycarbonate**, grey, similar to RAL 7035
Cover: **Polycarbonate**, transparent

Enclosure type	Height	Order No.
TK PC 2518-9-tm	90	137 008 01
TK PC 2518-11-tm	111	137 508 01
TK PC 2518-16-tm	165	138 008 01

also available in aluminium, see page 197

With knockouts

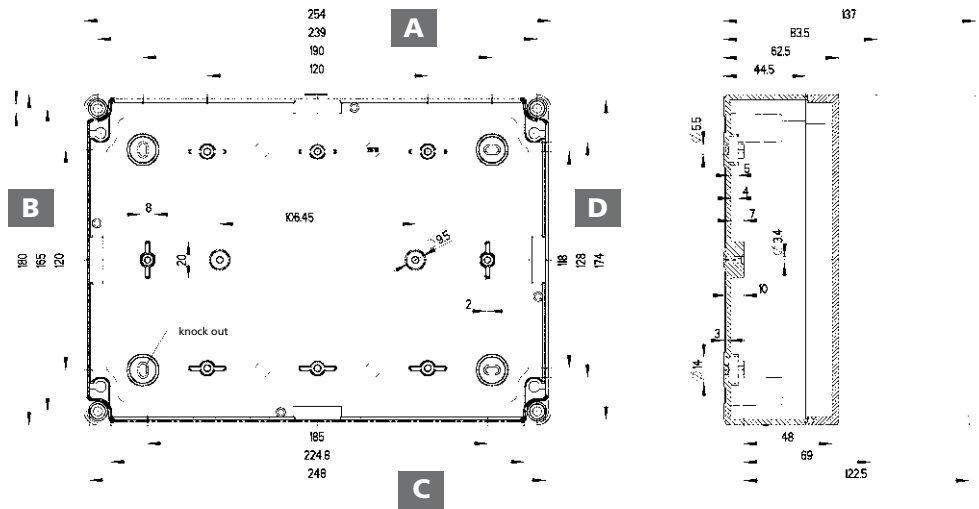
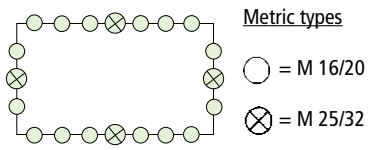

Without knockouts

Maximum possible through openings per box side

M	12	16	20	25	32	40	50
A/C	22	10	7	6	1	-	-
B/D	12	5	4	3	1	-	-

With knockouts

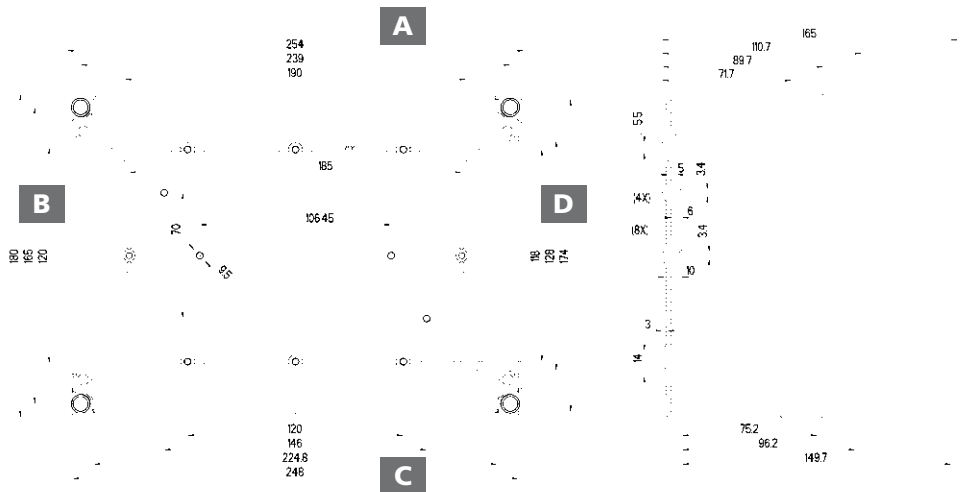
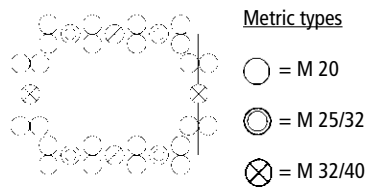

Without knockouts

Maximum possible through openings per box side

M	12	16	20	25	32	40	50
A/C	33	18	14	11	5	4	3
B/D	20	10	8	5	3	2	1



Base and cover: **Polystyrene**, grey, similar to RAL 7035

Enclosure type	Height	Order No.
TK PS 3625-11-m	111	105 412 01
TK PS 3625-16-m	165	105 912 01
TK PS 3625-11-o	111	110 412 01
TK PS 3625-16-o	165	110 912 01

Base and cover: **Polycarbonate**, grey, similar to RAL 7035

Enclosure type	Height	Order No.
TK PC 3625-11-m	111	127 412 01
TK PC 3625-16-m	165	127 912 01



Base: **Polystyrene**, grey, similar to RAL 7035
Cover: **Polycarbonate**, transparent

Enclosure type	Height	Order No.
TK PS 3625-11-tm	111	106 012 01
TK PS 3625-16-tm	165	106 512 01
TK PS 3625-11-to	111	111 012 01
TK PS 3625-16-to	165	111 512 01

Base: **Polycarbonate**, grey, similar to RAL 7035
Cover: **Polycarbonate**, transparent

Enclosure type	Height	Order No.
TK PC 3625-11-tm	111	137 012 01
TK PC 3625-16-tm	165	137 512 01

also available in aluminium, see page 197

With knockouts



Metric types

- = M 20
- ⊙ = M 25/32
- ⊗ = M 32/40

Without knockouts

Maximum possible through openings per box side

M	12	16	20	25	32	40	50
A/C	42	24	16	14	6	4	4
B/D	33	18	14	11	5	4	3

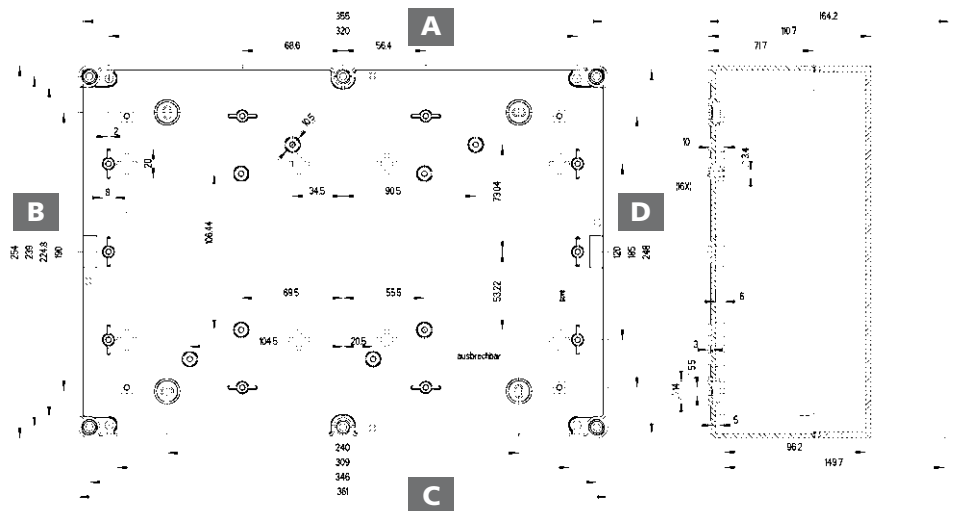



Empty enclosures TK AL

- 8 aluminium enclosures
- Powder-coated for corrosion protection
- Colour: light grey, similar to RAL 7035
- Material: Aluminium die-cast
- Effective protection against electromagnetic interference (EMI) and electrostatic discharge (ESD)
- Internal dimensions similar to TK PS / TK PC, mounting plates and standard rails likewise compatible

IP66

IK09



Industrial
Quality

Empty enclosures TK AL

TK AL 77-6 89 x 89 mm



Base and cover: **Aluminium**, powder-coated, light grey similar RAL 7035

Enclosure type	Height	Order No.
TK AL 77-6	64	151 001 01

Maximum possible through openings per box side

M	12	16	20	25	32	40	50
A/C	2	1	1	-	-	-	-
B/D	1	1	1	-	-	-	-

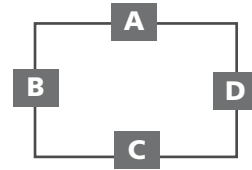

TK AL 99-6 119 x 119 mm



Base and cover: **Aluminium**, powder-coated, light grey similar RAL 7035

Enclosure type	Height	Order No.
TK AL 99-6	64	151 003 01

Maximum possible through openings per box side

M	12	16	20	25	32	40	50
A/C	6	3	2	1	-	-	-
B/D	3	1	1	1	-	-	-

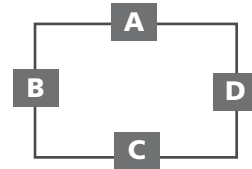

TK AL 1111-7 139 x 139 mm



Base and cover: **Aluminium**, powder-coated, light grey similar RAL 7035

Enclosure type	Height	Order No.
TK AL 1111-7	73	151 004 01

Maximum possible through openings per box side

M	12	16	20	25	32	40	50
A/C	8	3	3	2	1	-	-
B/D	6	5	2	1	1	-	-

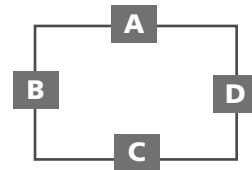

TK AL 1313-7 154 x 154 mm



Base and cover: **Aluminium**, powder-coated, light grey similar RAL 7035

Enclosure type	Height	Order No.
TK AL 1313-7	81	151 005 01

Maximum possible through openings per box side

M	12	16	20	25	32	40	50
A/C	10	6	5	3	2	-	-
B/D	8	5	3	2	1	-	-

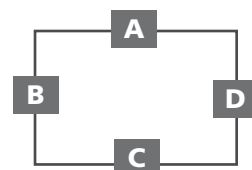

TK AL 1811-9 199 x 114 mm

Base and cover: **Aluminium**, powder-coated, light grey similar RAL 7035



Enclosure type	Height	Order No.
TK AL 1811-9	95	151 006 01

Maximum possible through openings per box side

M	12	16	20	25	32	40	50
A/C	21	10	8	6	3	2	2
B/D	6	3	2	1	1	-	-

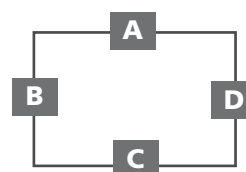

TK AL 1818-9 199 x 199 mm

Base and cover: **Aluminium**, powder-coated, light grey similar RAL 7035



Enclosure type	Height	Order No.
TK AL 1818-9	95	151 007 01

Maximum possible through openings per box side

M	12	16	20	25	32	40	50
A/C	21	14	8	8	3	2	2
B/D	18	9	8	6	1	2	-

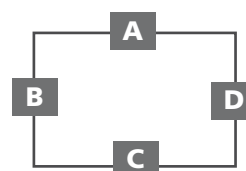

TK AL 2518-9 273 x 205 mm

Base and cover: **Aluminium**, powder-coated, light grey similar RAL 7035



Enclosure type	Height	Order No.
TK AL 2518-9	95	151 008 01

Maximum possible through openings per box side

M	12	16	20	25	32	40	50
A/C	33	18	14	12	5	4	3
B/D	18	10	8	6	3	2	1

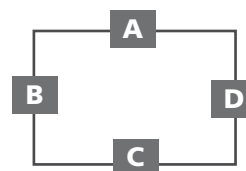

TK AL 3625-11 388 x 270 mm

Base and cover: **Aluminium**, powder-coated, light grey similar RAL 7035



Enclosure type	Height	Order No.
TK AL 3625-11	117	151 012 01

Maximum possible through openings per box side

M	12	16	20	25	32	40	50
A/C	48	35	22	17	8	6	4
B/D	27	18	12	9	4	3	2

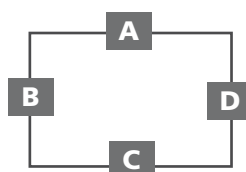

Mounting plate insulating material



Description

Order no.

Mounting plate made from insulating material with mounting plate bracket for assembly without tools, set of 5 pieces

	Enclosure type	
TK MPI-55	TK PS/PC 55	195 055 01
TK MPI-75	TK PS/PC 75	195 075 01

Mounting plate insulating material



Mounting plate made from insulating material, incl. fixing screws and spacers

	Enclosure type	
TK MPI-77	TK PS/PC/AL 77	195 001 01
TK MPI-97	TK PS/PC 97	195 002 01
TK MPI-99	TK PS/PC/AL 99	195 003 01
TK MPI-1111	TK PS/PC/AL 1111	195 004 01
TK MPI-1309	TK PS/PC 1309	195 009 01
TK MPI-1313	TK PS/PC/AL 1313	195 005 01
TK MPI-1809	TK PS/PC 1809	195 010 01

Mounting plate insulating material



Mounting plate made from insulating material, incl. fixing screws

	Enclosure type	
TK MPI-1811	TK PS/PC/AL 1811	195 006 01
TK MPI-1813	TK PS/PC 1813	195 011 01
TK MPI-1818	TK PS/PC/AL 1818	195 007 01
TK MPI-2518	TK PS/PC/AL 2518	195 008 01
TK MPI-3625	TK PS/PC/AL 3625	195 012 01

Mounting plate stainless steel



Mounting plate made from stainless steel, incl. fixing screws and spacers

	Enclosure type	
TK MPS-77	TK PS/PC/AL 77	197 001 01
TK MPS-97	TK PS/PC 97	197 002 01
TK MPS-99	TK PS/PC/AL 99	197 003 01
TK MPS-1111	TK PS/PC/AL 1111	197 004 01
TK MPS-1309	TK PS/PC 1309	197 009 01
TK MPS-1313	TK PS/PC/AL 1313	197 005 01
TK MPS-1809	TK PS/PC 1809	197 010 01

Mounting plate stainless steel



Mounting plate made from stainless steel, incl. fixing screws

	Enclosure type	
TK MPS-1811	TK PS/PC/AL 1811	197 006 01
TK MPS-1813	TK PS/PC 1813	197 011 01
TK MPS-1818	TK PS/PC/AL 1818	197 007 01
TK MPS-2518	TK PS/PC/AL 2518	197 008 01
TK MPS-3625	TK PS/PC/AL 3625	197 012 01

Standard rail NS 35

35 x 7,5 mm



Description

Order no.

Standard rail acc. to DIN EN 60715, 35 x 7.5, width 35 mm, incl. fixing screws

Enclosure type

NS 35-81	TK PS/PC 1111/1309/1313/1809/1811 + TK AL 1111/1313/1811	198 081 01
NS 35-106	TK PS/PC 1309/1313 + TK AL 1111/1313	198 106 01
NS 35-144	TK PS/PC 1809/1811/1813/1818/2518 + TK AL 1811/1818	198 144 01
NS 35-216	TK PS/PC 2518/3625 + TK AL 2518/3625	198 216 01
NS 35-336	TK PS/PC/AL 3625	198 336 01

Standard rail TS 15

15 x 5 mm



Standard rail acc. to DIN EN 60715, 15 x 5, width 15 mm, incl. fixing screws

Enclosure type

TS 15-49,5	TK PS/PC 77/97 + TK AL 77	197 049 01
TS 15-80	TK PS/PC 97/99/1111/1309/1313/1809/1811 + TK AL 99/1111/1313/1811	197 080 01
TS 15-92	TK PS/PC 1111/1309/1313/1809/1811 + TK AL 1111/1313/1811	197 092 01
TS 15-111	TK PS/PC 1309/1313 + TK AL 1111/1313	197 111 01
TS 15-154	TK PS/PC 1809/1811/1813/1818/2518 + TK AL 1818/2518	197 154 01

Spacer kit TK DST

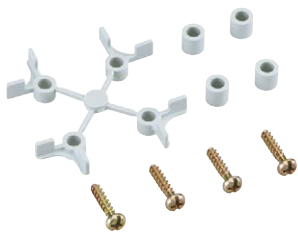

Spacer kit TK DST for creating a space between enclosure bottom and conductor or mounting plate 4 pieces spacing 6 mm, 4 pieces spacing 8 mm, incl. fixing screws for TK PS/PC

TK DST

194 100 01

Mounting/PCB holder

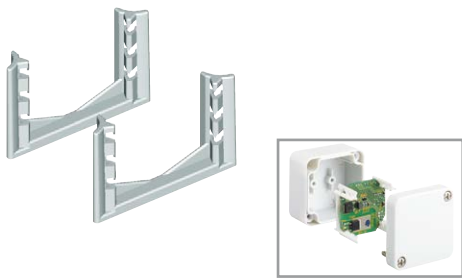

Mounting/PCB holder made of plastic, suitable for assembly without tools in TK 55 and TK 75

TK MLH-55/75
Set = 25 pairs

194 110 01

External fixing plate



External mounting plate made of plastic, for TK 55 and TK 75

TK ABP-55/75
Set = 10 pcs.

194 002 01

Empty enclosures

External hinge set



Description

External hinge set for retrofitting the enclosure cover to hinged door, incl. 2 hinges, fixing screws, cover plugs and drilling template

Order no.

ASS-kl

External hinge set small, TK PS/PC 77 bis TK PS/PC 1809

190 002 01

ASS-gro

External hinge set large, from TK PS/PC 1811 and from AKL/AKi 1

190 005 01

Padlock kit



Padlock kit for upgrading the housing cover to lockable hinged door, incl. padlock, 2 hinges, fixing screws, cover plugs and drilling template

VSG

from TK PS/PC 1811 onwards and AKL/AKi 1

190 100 01

External fixing lugs set



External fixing lugs set made of plastic, for all TK PS/PC, RK enclosures, from TK PS/PC 77

TK ABL

Set = 4 pcs.

194 001 01

Mounting material



Mounting material made of plastic, for clipping on the standard cover screw, from TK PS/PC 77

HBA

Set = 4 pcs.

190 001 01

Partition wall



divider made of plastic, suitable for the separation of two electric circuits

TK TW-n

for TK PS/PC 1309-6 and TK PS/PC 1809-6

196 009 01

TK TW-h

for TK PS/PC 1309-8 and TK PS/PC 1809-8

196 909 01

External hinge set



Description

Order no.

For retrofitting the enclosure cover to hinged door. Incl. 2 hinges, fixing screws, masking-off strips and drilling template

AL ASS	for AL/ALR 1010, 1212, 1616, 2212, 2320, 2616, 2823, 3323, 3616, for TK AL 1313, 1811, 1818, 2518, 3625	154 210 01
---------------	---	------------

External fixing lugs



External fixing lugs

AL ALS-kl	for AL/ALR 88, 1006, 1010, 1308, 1506, 1808, for TK AL 77/99	154 004 01
------------------	--	------------

AL ALS-gro	for AL/ALR 1212, 1616, 2212, 2320, 2616, 2823, 3323, 3616, for TK AL 1111, 1313, 1811, 1818, 2518, 3625	154 006 01
-------------------	---	------------

Handle



Handle made of plastic, for mobile use of housing, screw spacing 120 mm

TG 2	with self-cutting screws	191 805 01
TG 1	with screws M6 and nuts made of plastic	191 800 01

Combi set



IP66

Combi set, for side connection of enclosures with metric entries, complete with lock nuts and intermediate wall seal inserts

	f. wall thicknesses/ mm	Thread length/mm	
KS M20	2 x 3,0	12	192 020 01
KS M25-gro	2,0 x 8,0	22	192 026 01
KS M25	2 x 3,0	12	192 025 01
KS M32	2 x 3,5	14	192 032 01

Combi set

176 x 65 mm

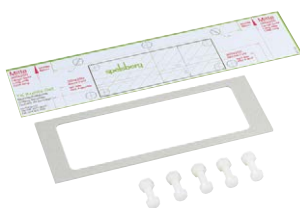

IP66

Combi set for combining enclosures from TK PS/PC 1811 (except for flat design), complete with screws and nuts made from plastic, intermediate sealing and drilling template

TK KS GRO	192 018 01
------------------	------------

Special screwdriver



Description

Order no.

Special screwdriver for actuating the TK lid screw

TK SDR T40

195 018 01

Cover screw



Cover screw as additional screw, from TK PS/PC 77

	for cover	Color	
TK DS-ku/g	flat	Grey	190 010 01
TK DS-ku/sw	flat	black	190 012 01
TK DS-lg/g	high	Grey	190 011 01
TK DS-lg/sw	high	black	190 013 01

Hole cutter

79 mm



Hole cutter

LFR
Through opening: M16-32, drill hole: 16.5-32.5 mm

195 995 01

Installation screw



Self-cutting screw, for mounting assembly parts in TK PC 55 / 75 / 1005

TK ES-55/75/1005

190 200 01

Cover screw with special head



Cover screw prevents opening by unauthorised persons, can be sealed additionally, special screwdriver required, set=12 pieces, from TK PS/PC 77

	for cover	Color	
TK DS-ku/g/T40	flat	Grey	190 014 01
TK DS-ku/sw/T40	flat	black	190 015 01
TK DS-lg/g/T40	high	Grey	190 016 01
TK DS-lg/sw/T40	high	black	190 017 01



Empty enclosures TG PC

- ▷ Ammonia resistance
- ▷ Resistance against stable air for minimum 20 years

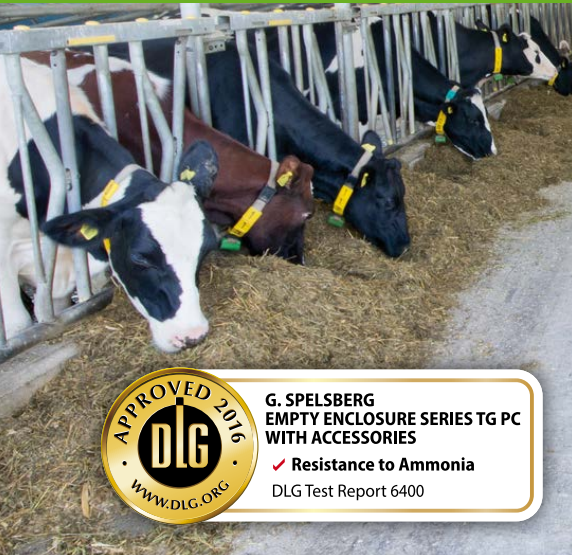

**G. SPELSBERG
EMPTY ENCLOSURE SERIES TG PC
WITH ACCESSORIES**
✓ Resistance to Ammonia
DLG Test Report 6400



- 9 basic enclosures in various heights
- High-quality design with a stylish high-gloss appearance
- Grey or transparent covers
- Plastic, choice of ABS (TG ABS) or polycarbonate (TG PC)
- Smooth side walls for added flexibility
- Attachment points in the usual positions
- Time-saving stainless steel snap lock
- Cover screws available on request

IP67
IP66

IK07



690V
AC

1000V
DC



IP67
IP66

IK08



690V
AC

1000V
DC



Empty enclosure TG ABS / TG PC



- ▶ Recess in cover facilitates placement of decals or membrane keypads
- ▶ Individual choice of attachments
- ▶ Internal hinges



TG 88-6

84 x 82 mm

Base and cover: **ABS**, grey, similar RAL 7035

Enclosure type	Height	Order No.
TG ABS 88-6-o	55	100 403 01

Base and cover: **Polycarbonate**, grey, similar RAL 7035

Enclosure type	Height	Order No.
TG PC 88-6-o	55	200 403 01

Base: **ABS**, grey, similar RAL 7035
Cover: **Polycarbonate**, transparent

Enclosure type	Height	Order No.
TG ABS 88-6-to	55	101 003 01

Base: **Polycarbonate**, grey, similar RAL 7035
Cover: **Polycarbonate**, transparent

Enclosure type	Height	Order No.
TG PC 88-6-to	55	201 003 01

TG 88-9

84 x 82 mm

Base and cover: **ABS**, grey, similar RAL 7035

Enclosure type	Height	Order No.
TG ABS 88-9-o	85	100 903 01

Base and cover: **Polycarbonate**, grey, similar RAL 7035

Enclosure type	Height	Order No.
TG PC 88-9-o	85	200 903 01

Base: **ABS**, grey, similar RAL 7035
Cover: **Polycarbonate**, transparent

Enclosure type	Height	Order No.
TG ABS 88-9-to	85	101 503 01

Base: **Polycarbonate**, grey, similar RAL 7035
Cover: **Polycarbonate**, transparent

Enclosure type	Height	Order No.
TG PC 88-9-to	85	201 503 01

Maximum possible metric through openings per box side

M	A/C	B/D
12	3	2
16	2	1
20	1	1
25	-	-
32	-	-
40	-	-
50	-	-

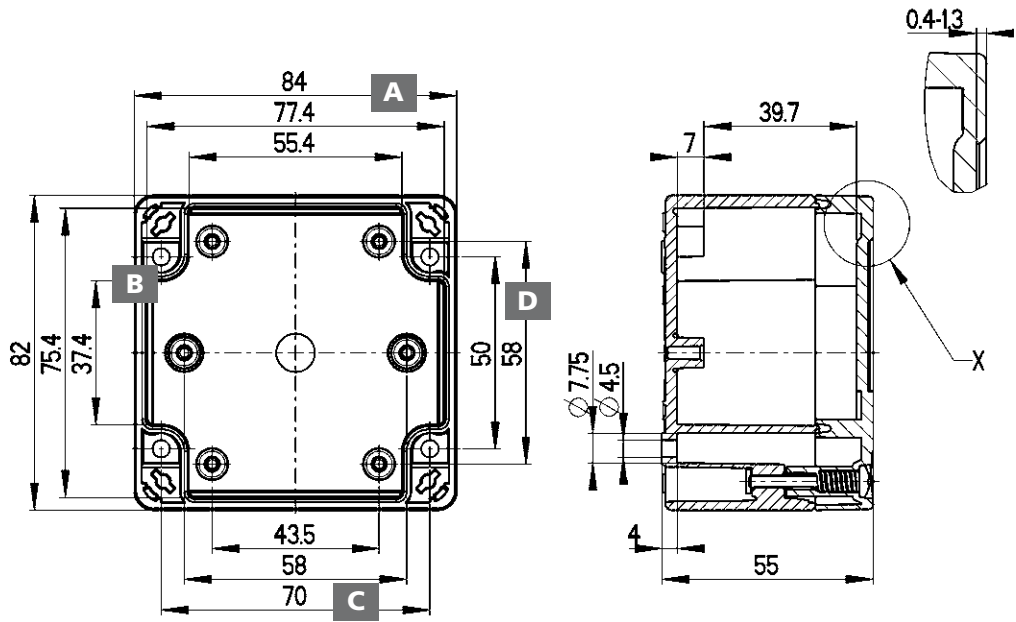

Maximum possible metric through openings per box side

M	A/C	B/D
12	6	4
16	4	2
20	2	2
25	1	1
32	1	-
40	-	-
50	-	-

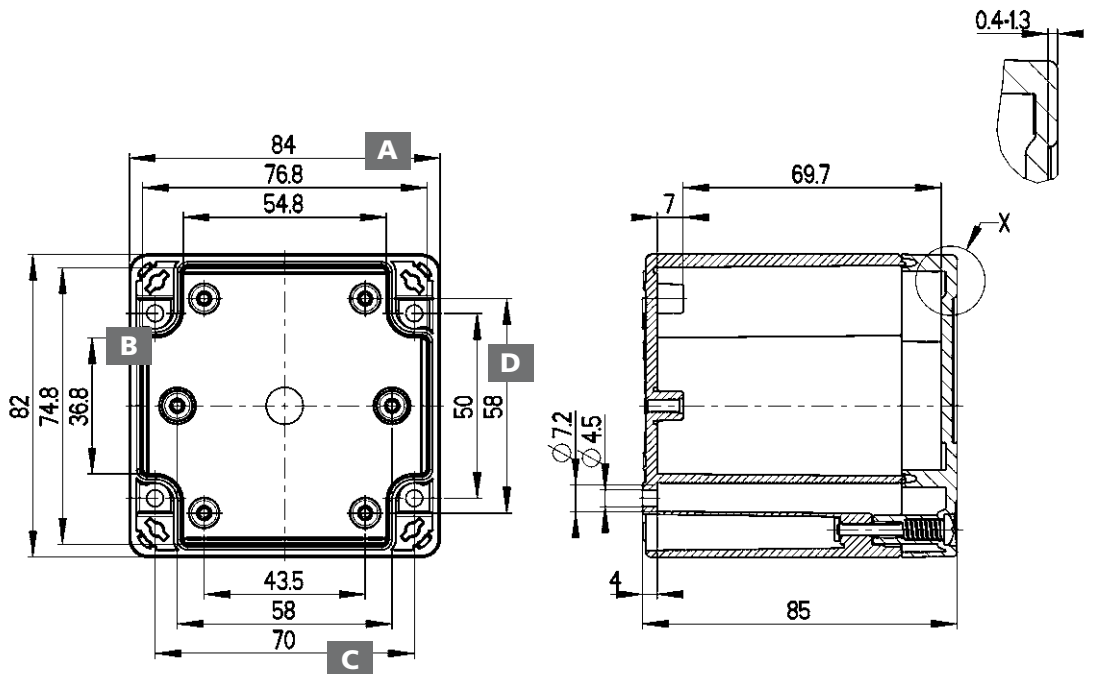

Empty enclosures

TG 1208-6 122 x 82 mm



Base and cover: **ABS**, grey, similar RAL 7035

Enclosure type	Height	Order No.
TG ABS 1208-6-o	55	100 404 01

Base and cover: **Polycarbonate**, grey, similar RAL 7035

Enclosure type	Height	Order No.
TG PC 1208-6-o	55	200 404 01

Base: **ABS**, grey, similar RAL 7035
Cover: **Polycarbonate**, transparent



Enclosure type	Height	Order No.
TG ABS 1208-6-to	55	101 004 01

Base: **Polycarbonate**, grey, similar RAL 7035
Cover: **Polycarbonate**, transparent

Enclosure type	Height	Order No.
TG PC 1208-6-to	55	201 004 01

TG 1208-9 122 x 82 mm



Base and cover: **ABS**, grey, similar RAL 7035

Enclosure type	Height	Order No.
TG ABS 1208-9-o	85	100 904 01

Base and cover: **Polycarbonate**, grey, similar RAL 7035

Enclosure type	Height	Order No.
TG PC 1208-9-o	85	200 904 01

Base: **ABS**, grey, similar RAL 7035
Cover: **Polycarbonate**, transparent



Enclosure type	Height	Order No.
TG ABS 1208-9-to	85	101 504 01

Base: **Polycarbonate**, grey, similar RAL 7035
Cover: **Polycarbonate**, transparent

Enclosure type	Height	Order No.
TG PC 1208-9-to	85	201 504 01

Maximum possible metric through openings per box side

M	A/C	B/D
12	5	2
16	3	1
20	2	-
25	2	-
32	-	-
40	-	-
50	-	-

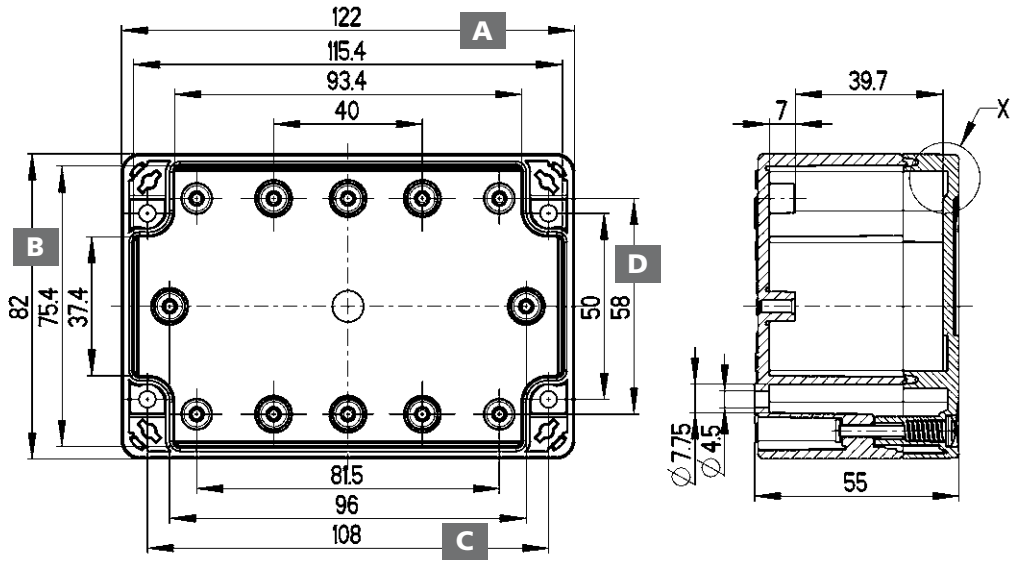

Maximum possible metric through openings per box side

M	A/C	B/D
12	12	4
16	6	2
20	6	1
25	3	1
32	2	-
40	1	-
50	-	-

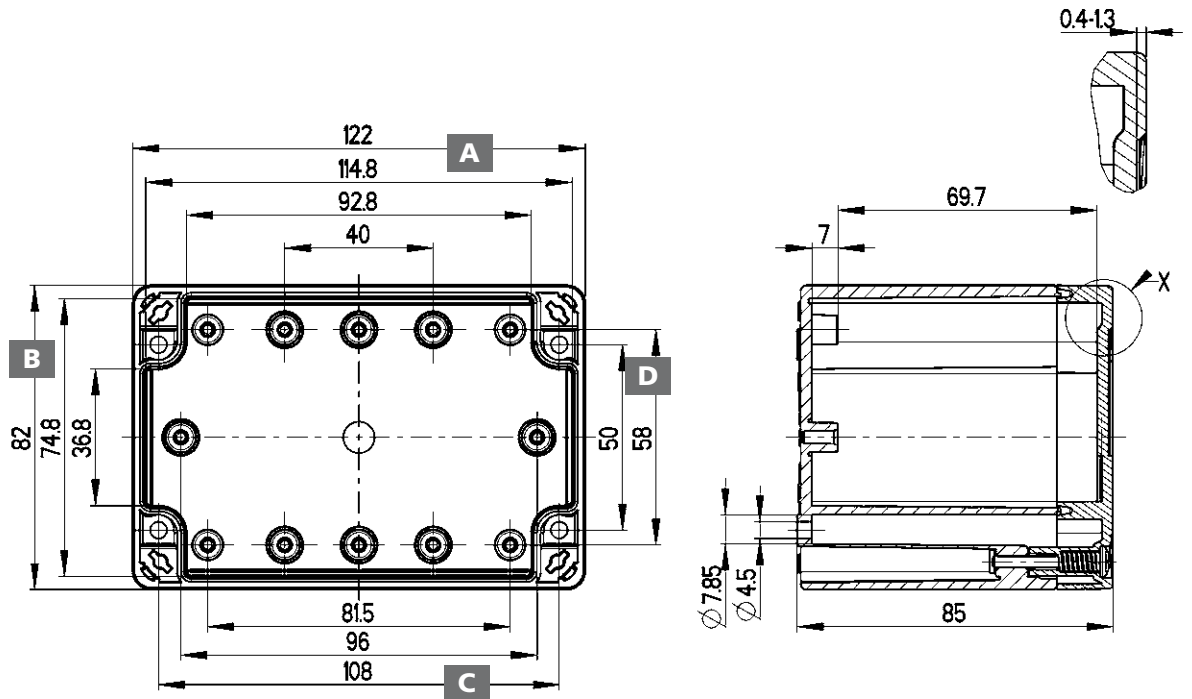

Empty enclosures

TG 1212-6 124 x 122 mm



Base and cover: **ABS**, grey, similar RAL 7035

Enclosure type	Height	Order No.
TG ABS 1212-6-o	55	100 405 01

Base and cover: **Polycarbonate**, grey, similar RAL 7035

Enclosure type	Height	Order No.
TG PC 1212-6-o	55	200 405 01

Base: **ABS**, grey, similar RAL 7035
Cover: **Polycarbonate**, transparent



Enclosure type	Height	Order No.
TG ABS 1212-6-to	55	101 005 01

Base: **Polycarbonate**, grey, similar RAL 7035
Cover: **Polycarbonate**, transparent

Enclosure type	Height	Order No.
TG PC 1212-6-to	55	201 005 01

TG 1212-9 124 x 122 mm



Base and cover: **ABS**, grey, similar RAL 7035

Enclosure type	Height	Order No.
TG ABS 1212-9-o	85	100 905 01

Base and cover: **Polycarbonate**, grey, similar RAL 7035

Enclosure type	Height	Order No.
TG PC 1212-9-o	85	200 905 01

Base: **ABS**, grey, similar RAL 7035
Cover: **Polycarbonate**, transparent



Enclosure type	Height	Order No.
TG ABS 1212-9-to	85	101 505 01

Base: **Polycarbonate**, grey, similar RAL 7035
Cover: **Polycarbonate**, transparent

Enclosure type	Height	Order No.
TG PC 1212-9-to	85	201 505 01

Maximum possible metric through openings per box side

M	A/C	B/D
12	6	5
16	3	3
20	3	2
25	2	2
32	-	-
40	-	-
50	-	-

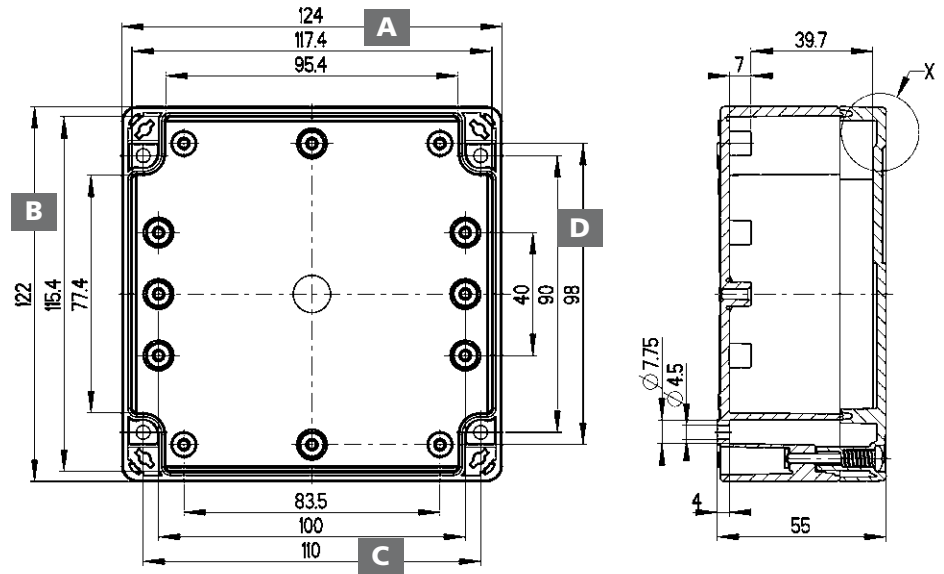

Maximum possible metric through openings per box side

M	A/C	B/D
12	12	9
16	6	6
20	6	4
25	3	2
32	2	1
40	1	1
50	1	-

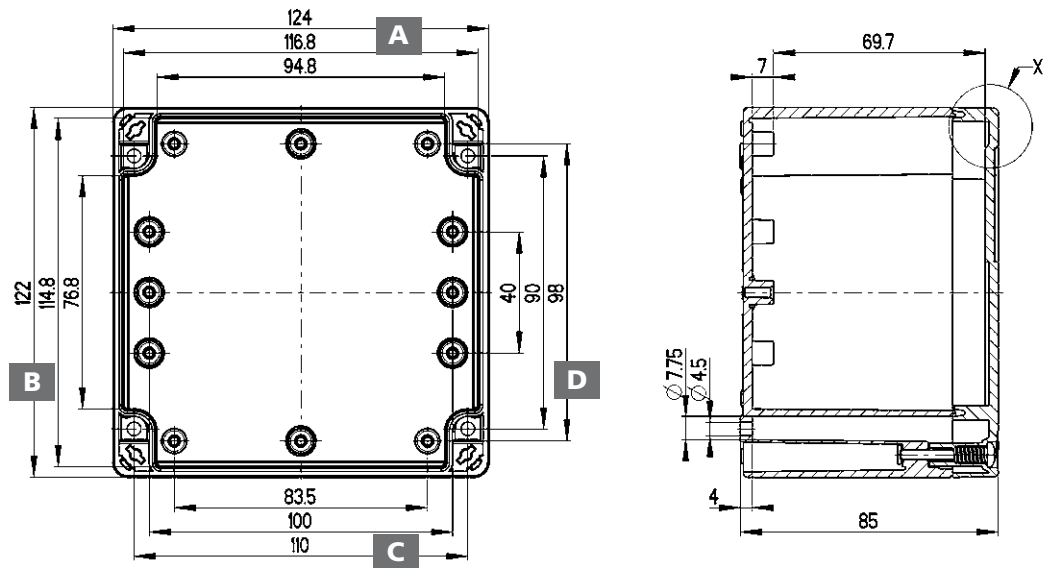

Empty enclosures

TG 1608-6 162 x 82 mm

Base and cover: **ABS**, grey, similar RAL 7035

Enclosure type	Height	Order No.
TG ABS 1608-6-o	55	100 406 01

Base and cover: **Polycarbonate**, grey, similar RAL 7035

Enclosure type	Height	Order No.
TG PC 1608-6-o	55	200 406 01

Base: **ABS**, grey, similar RAL 7035
Cover: **Polycarbonate**, transparent



Enclosure type	Height	Order No.
TG ABS 1608-6-to	55	101 006 01

Base: **Polycarbonate**, grey, similar RAL 7035
Cover: **Polycarbonate**, transparent

Enclosure type	Height	Order No.
TG PC 1608-6-to	55	201 006 01

TG 1608-9 162 x 82 mm

Base and cover: **ABS**, grey, similar RAL 7035

Enclosure type	Height	Order No.
TG ABS 1608-9-o	85	100 906 01

Base and cover: **Polycarbonate**, grey, similar RAL 7035

Enclosure type	Height	Order No.
TG PC 1608-9-o	85	200 906 01

Base: **ABS**, grey, similar RAL 7035
Cover: **Polycarbonate**, transparent



Enclosure type	Height	Order No.
TG ABS 1608-9-to	85	101 506 01

Base: **Polycarbonate**, grey, similar RAL 7035
Cover: **Polycarbonate**, transparent

Enclosure type	Height	Order No.
TG PC 1608-9-to	85	201 506 01

Maximum possible metric through openings per box side

M	A/C	B/D
12	9	2
16	5	1
20	4	1
25	-	-
32	-	-
40	-	-
50	-	-

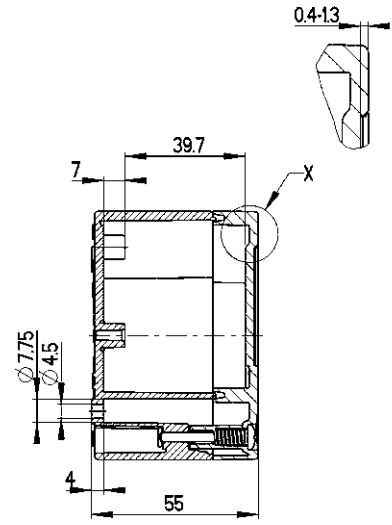
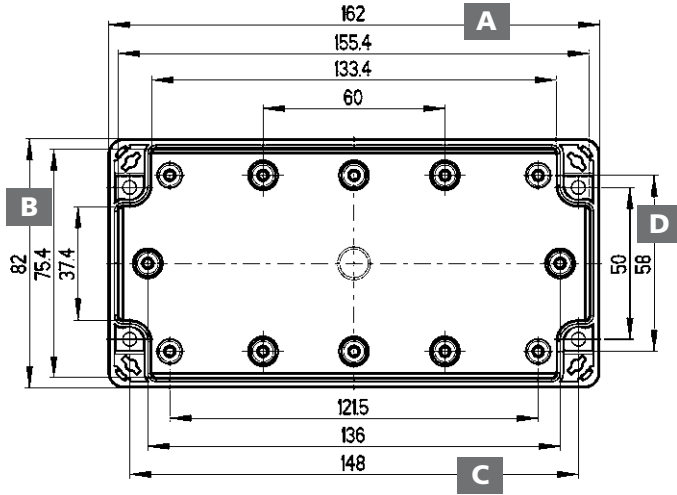

Maximum possible metric through openings per box side

M	A/C	B/D
12	18	4
16	10	2
20	8	2
25	4	1
32	3	-
40	2	-
50	2	-

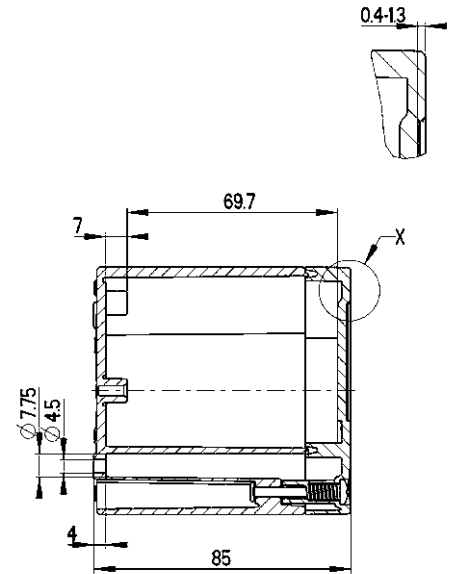
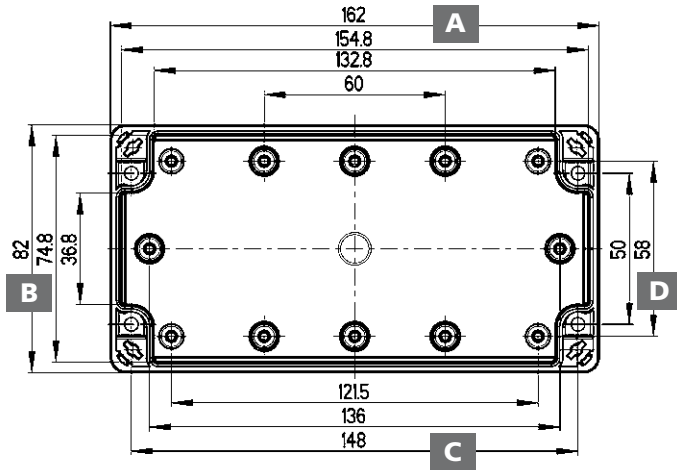

Empty enclosures

TG 1612-9 162 x 122 mm



Base and cover: **ABS**, grey, similar RAL 7035

Enclosure type	Height	Order No.
TG ABS 1612-9-o	90	100 407 01

Base and cover: **Polycarbonate**, grey, similar RAL 7035

Enclosure type	Height	Order No.
TG PC 1612-9-o	90	200 407 01

Base: **ABS**, grey, similar RAL 7035
Cover: **Polycarbonate**, transparent



Enclosure type	Height	Order No.
TG ABS 1612-9-to	90	101 007 01

Base: **Polycarbonate**, grey, similar RAL 7035
Cover: **Polycarbonate**, transparent

Enclosure type	Height	Order No.
TG PC 1612-9-to	90	201 007 01

TG 2012-8 202 x 122 mm



Base and Cover: **ABS**, grey, similar RAL 7035

Enclosure type	Height	Order No.
TG ABS 2012-8-o	75	100 408 01

Base and cover: **Polycarbonate**, grey, similar RAL 7035

Enclosure type	Height	Order No.
TG PC 2012-8-o	75	200 408 01

Base: **ABS**, grey, similar RAL 7035
Cover: **Polycarbonate**, transparent



Enclosure type	Height	Order No.
TG ABS 2012-8-to	75	101 008 01

Base: **Polycarbonate**, grey, similar RAL 7035
Cover: **Polycarbonate**, transparent

Enclosure type	Height	Order No.
TG PC 2012-8-to	75	201 008 01

Maximum possible metric through openings per box side

M	A/C	B/D
12	9	2
16	5	1
20	4	1
25	-	-
32	-	-
40	-	-
50	-	-

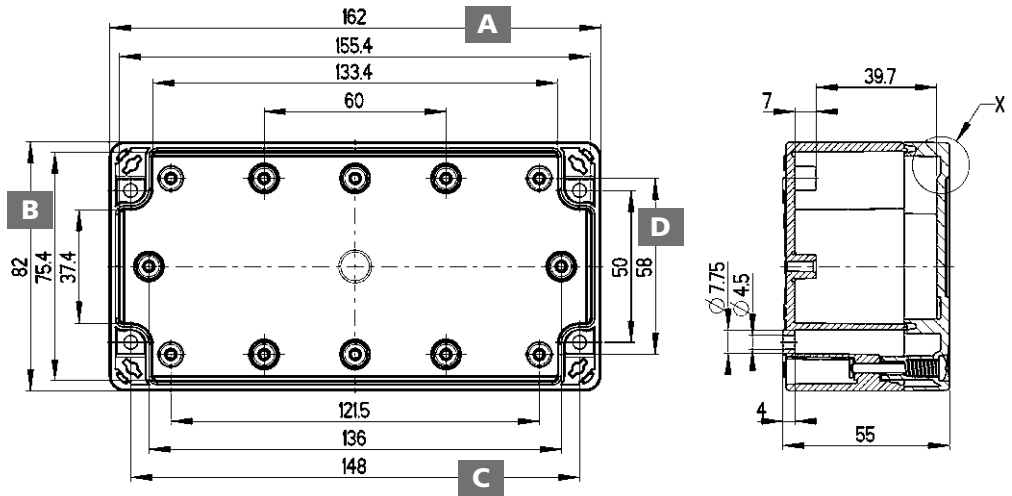

Maximum possible metric through openings per box side

M	A/C	B/D
12	16	6
16	8	3
20	5	2
25	4	2
32	-	-
40	-	-
50	-	-

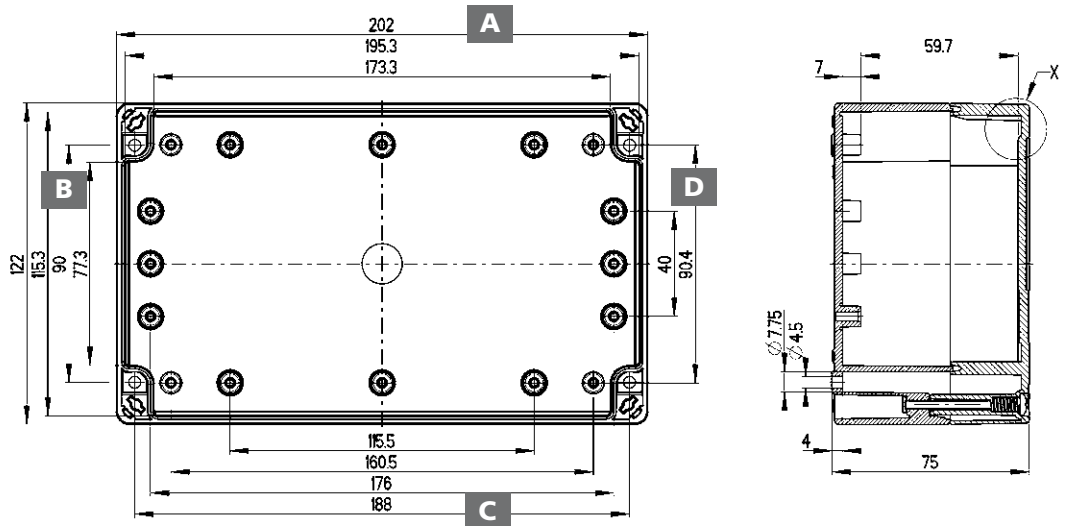

Empty enclosures

TG 2012-9 202 x 122 mm



Base and cover: **ABS**, grey, similar RAL 7035

Enclosure type	Height	Order No.
TG ABS 2012-9-o	90	100 908 01

Base and cover: **Polycarbonate**, grey, similar RAL 7035

Enclosure type	Height	Order No.
TG PC 2012-9-o	90	200 908 01



Base: **ABS**, grey, similar RAL 7035
Cover: **Polycarbonate**, transparent

Enclosure type	Height	Order No.
TG ABS 2012-9-to	90	101 508 01

Base: **Polycarbonate**, grey, similar RAL 7035
Cover: **Polycarbonate**, transparent

Enclosure type	Height	Order No.
TG PC 2012-9-to	90	201 508 01

TG 2015-9 202 x 152 mm



Base and cover: **ABS**, grey, similar RAL 7035

Enclosure type	Height	Order No.
TG ABS 2015-9-o	90	100 409 01

Base and cover: **Polycarbonate**, grey, similar RAL 7035

Enclosure type	Height	Order No.
TG PC 2015-9-o	90	200 409 01



Base: **ABS**, grey, similar RAL 7035
Cover: **Polycarbonate**, transparent

Enclosure type	Height	Order No.
TG ABS 2015-9-to	90	101 009 01

Base: **Polycarbonate**, grey, similar RAL 7035
Cover: **Polycarbonate**, transparent

Enclosure type	Height	Order No.
TG PC 2015-9-to	90	201 009 01

Maximum possible metric through openings per box side

M	A/C	B/D
12	16	6
16	12	3
20	5	3
25	4	2
32	3	1
40	-	-
50	-	-

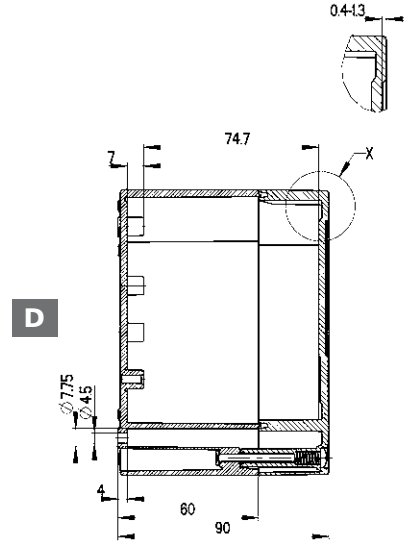
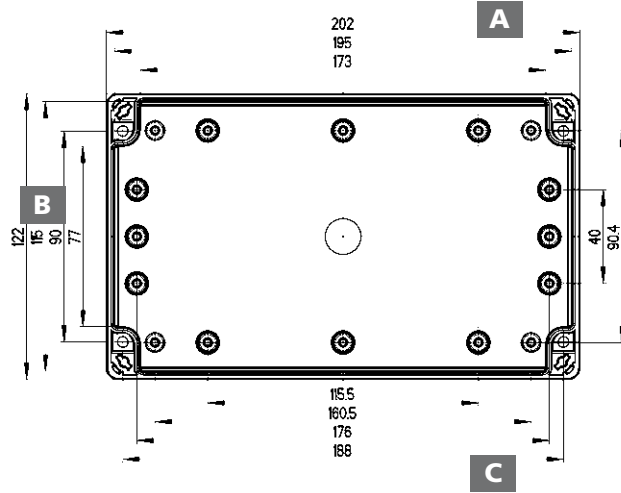

Maximum possible metric through openings per box side

M	A/C	B/D
12	16	10
16	12	8
20	5	4
25	4	3
32	3	2
40	-	-
50	-	-

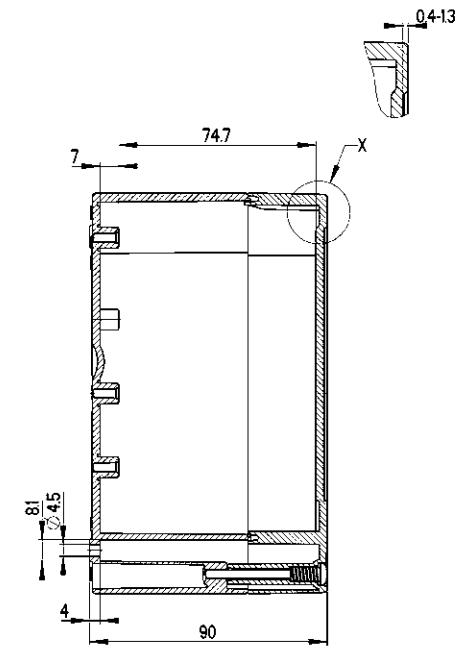
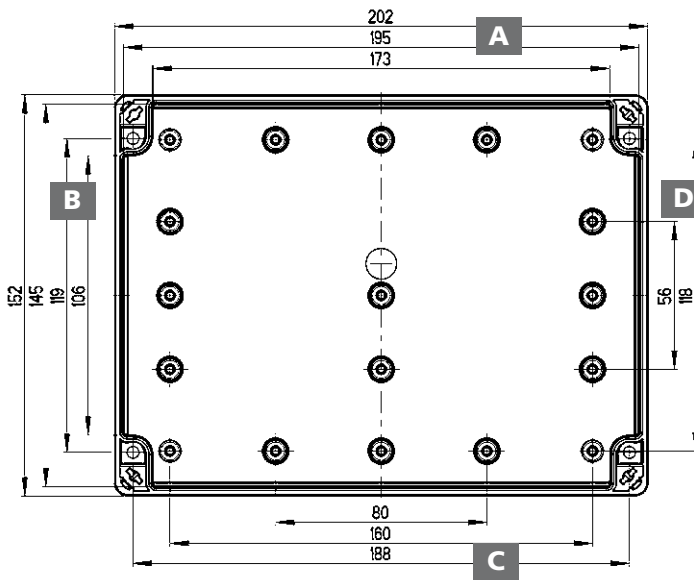

Empty enclosures

TG 2516-9 252 x 162 mm



Base and cover: **ABS**, grey, similar RAL 7035

Enclosure type	Height	Order No.
TG ABS 2516-9-o	90	100 412 01

Base and cover: **Polycarbonate**, grey, similar RAL 7035

Enclosure type	Height	Order No.
TG PC 2516-9-o	90	200 412 01



Base: **ABS**, grey, similar RAL 7035
Cover: **Polycarbonate**, transparent

Enclosure type	Height	Order No.
TG ABS 2516-9-to	90	101 012 01

Base: **Polycarbonate**, grey, similar RAL 7035
Cover: **Polycarbonate**, transparent

Enclosure type	Height	Order No.
TG PC 2516-9-to	90	201 012 01

TG 2516-12 252 x 162 mm



Base and cover: **ABS**, grey, similar RAL 7035

Enclosure type	Height	Order No.
TG ABS 2516-12-o	120	100 912 01

Base and cover: **Polycarbonate**, grey, similar RAL 7035

Enclosure type	Height	Order No.
TG PC 2516-12-o	120	200 912 01



Base: **ABS**, grey, similar RAL 7035
Cover: **Polycarbonate**, transparent

Enclosure type	Height	Order No.
TG ABS 2516-12-to	120	101 512 01

Base: **Polycarbonate**, grey, similar RAL 7035
Cover: **Polycarbonate**, transparent

Enclosure type	Height	Order No.
TG PC 2016-12-to	120	201 512 01

Maximum possible metric through openings per box side

M	A/C	B/D
12	20	10
16	12	8
20	6	3
25	4	3
32	4	2
40	2	2
50	-	-

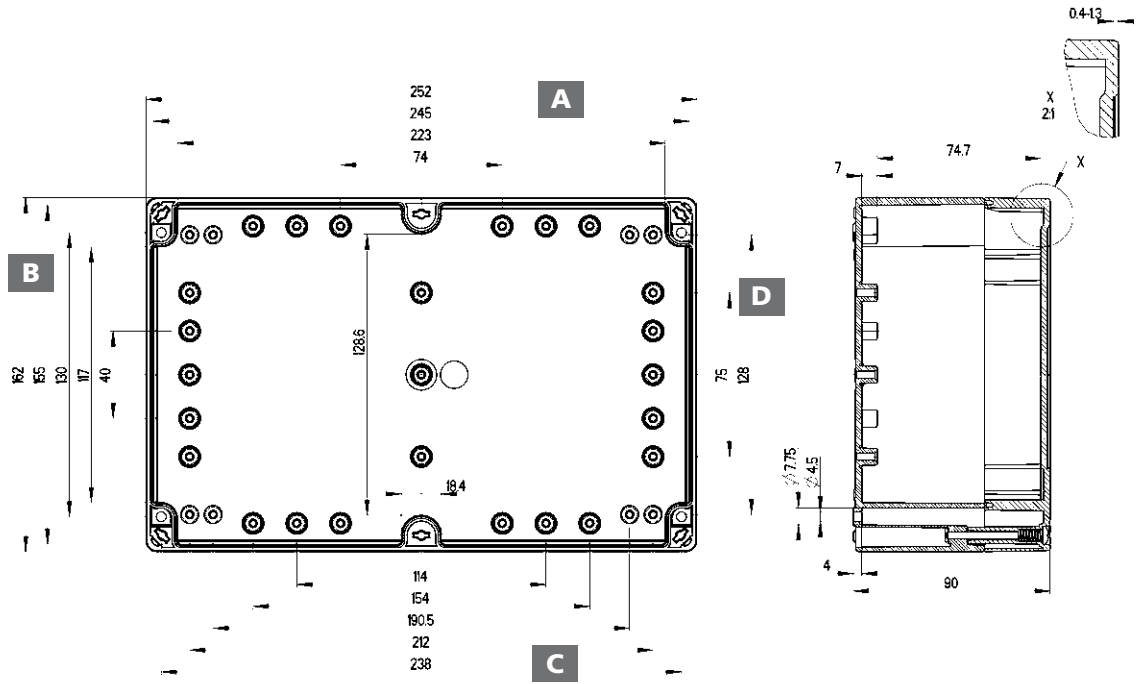

Maximum possible metric through openings per box side

M	A/C	B/D
12	40	20
16	18	12
20	12	8
25	8	6
32	6	3
40	2	2
50	2	1

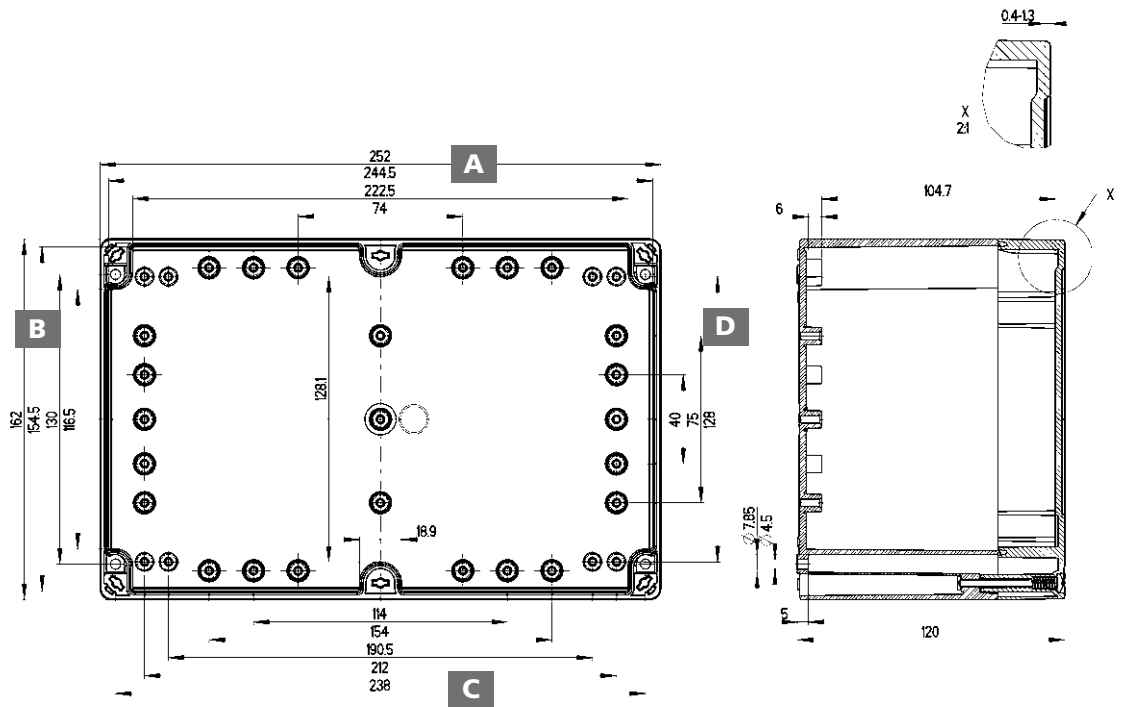

Empty enclosures

TG 3023-9 302 x 232 mm

Base and cover: **ABS**, grey, similar RAL 7035

Enclosure type	Height	Order No.
TG ABS 3023-9-o	90	100 413 01

Base and cover: **Polycarbonate**, grey, similar RAL 7035

Enclosure type	Height	Order No.
TG PC 3023-9-o	90	200 413 01

Base: **ABS**, grey, similar RAL 7035
Cover: **Polycarbonate**, transparent



Enclosure type	Height	Order No.
TG ABS 3023-9-to	90	101 013 01

Base: **Polycarbonate**, grey, similar RAL 7035
Cover: **Polycarbonate**, transparent

Enclosure type	Height	Order No.
TG PC 3023-9-to	90	201 013 01

TG 3023-11 302 x 232 mm

Base and cover: **ABS**, grey, similar RAL 7035

Enclosure type	Height	Order No.
TG ABS 3023-11-o	110	100 913 01

Base and cover: **Polycarbonate**, grey, similar RAL 7035

Enclosure type	Height	Order No.
TG PC 3023-11-o	110	200 913 01

Base: **ABS**, grey, similar RAL 7035
Cover: **Polycarbonate**, transparent



Enclosure type	Height	Order No.
TG ABS 3023-11-to	110	101 513 01

Base: **Polycarbonate**, grey, similar RAL 7035
Cover: **Polycarbonate**, transparent

Enclosure type	Height	Order No.
TG PC 3023-11-to	110	201 513 01

Maximum possible metric through openings per box side

M	A/C	B/D
12	24	18
16	16	14
20	8	6
25	6	5
32	4	4
40	4	2
50	-	-

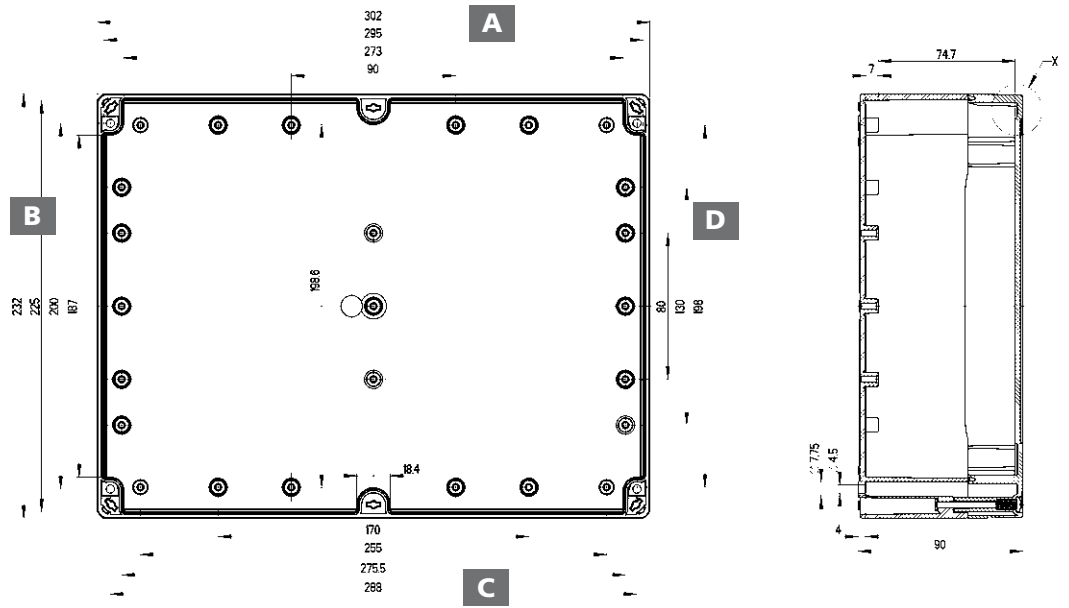

Maximum possible metric through openings per box side

M	A/C	B/D
12	36	27
16	26	20
20	16	12
25	12	9
32	6	4
40	4	3
50	2	2

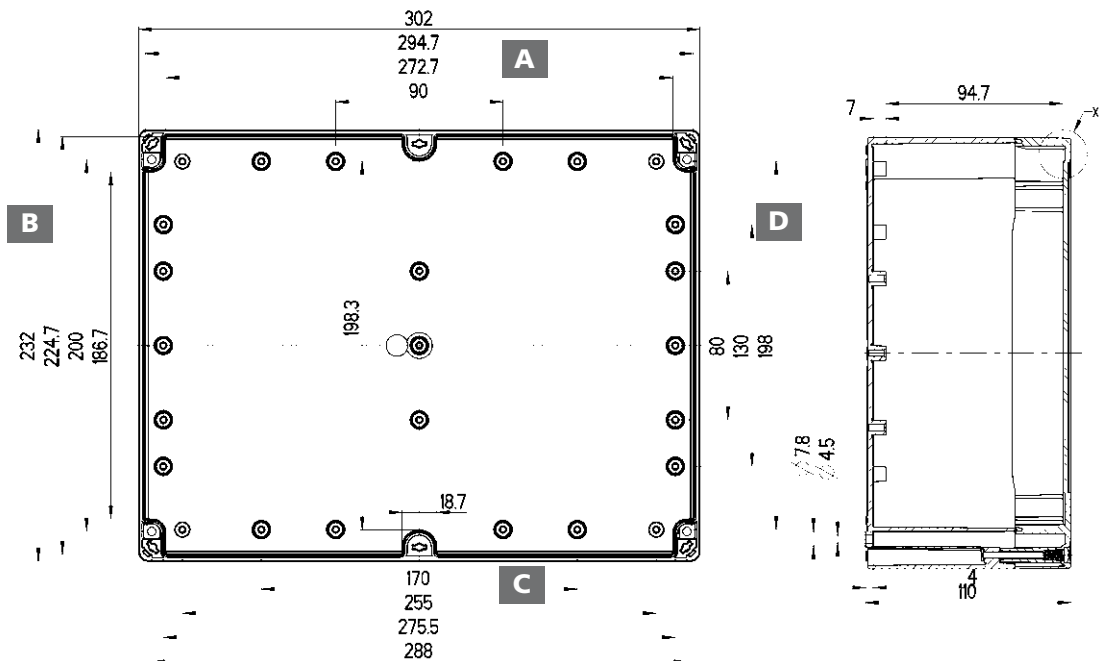

Empty enclosures

Mounting plate insulating material



Description

Order no.

Mounting plate made from insulating material

	Enclosure type	
TG MPI-88	TG 88	186 003 01
TG MPI-1208	TG 1208	186 004 01
TG MPI-1212	TG 1212	186 005 01
TG MPI-1608	TG 1608	186 006 01
TG MPI-1612	TG 1612	186 007 01
TG MPI-2012	TG 2012	186 008 01
TG MPI-2015	TG 2015	186 009 01
TG MPI-2516	TG 2516	186 012 01
TG MPI-3023	TG 3023	186 013 01

Mounting plate stainless steel



Mounting plate made from stainless steel

	Enclosure type	
TG MPS-88	TG 88	187 003 01
TG MPS-1208	TG 1208	187 004 01
TG MPS-1212	TG 1212	187 005 01
TG MPS-1608	TG 1608	187 006 01
TG MPS-1612	TG 1612	187 007 01
TG MPS-2012	TG 2012	187 008 01
TG MPS-2015	TG 2015	187 009 01
TG MPS-2516	TG 2516	187 012 01
TG MPS-3023	TG 3023	187 013 01

Standard rail NS 35

35 x 7,5 mm



Standard rail acc. to DIN EN 60715, 35 x 7.5, width 35 mm

	Enclosure type	
NS 35-66	TG 88	198 068 01
NS 35-104	TG 1208	198 107 01
NS 35-108	TG 1212	198 110 01
NS 35-144/2	TG 1608, TG 1612	198 146 01
NS 35-184	TG 2012	198 186 01
NS 35-168	TG 2015	198 170 01
NS 35-220	TG 2516	198 222 01
NS 35-283,5	TG 3023	198 285 01

Standard rail TS 15

15 x 5 mm



Standard rail according to DIN EN 60715, 15 x 5 width

	Enclosure type	
TS 15-66	TG 88	197 069 01
TS 15-104	TG 1208	197 107 01
TS 15-108	TG 1212	197 110 01
TS 15-144	TG 1608, TG 1612	197 146 01
TS 15-184	TG 2012	197 186 01
TS 15-168	TG 2015	197 170 01
TS 15-220	TG 2516	197 222 01
TS 15-283,5	TG 3023	197 285 01

Interior hinge set

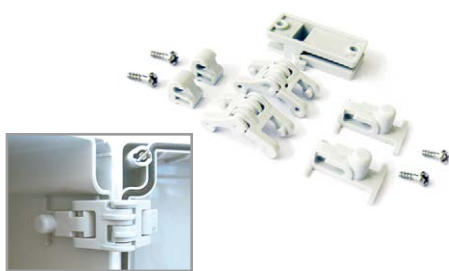

application example

Description

Order no.

Interior hinge set for retrofitting the housing cover to a hinged door, incl. 2 hinges, fixing screws and drilling template

TG ISS
for TG 1612, TG 2012, TG 2015, TG 2516, TG 3023

182 001 01

External fixing lugs set



External fixing lugs set, made of plastic

TG ABL
for all TG enclosures, set = 4 pcs.

182 002 01

Sealing set



application example

Sealing set

TG PST1
for TG 88, TG 1208, TG 1212, TG 1608

182 004 01

TG PST2
for TG 1612, TG 2012, TG 2015, TG 2516, TG 3023

182 005 01

Cover retainer



application example

Spare cover retainer, set = 10 pcs.

TG DVS-42 for TG 88, TG 1208, TG 1212, TG 1608

182 006 01

TG DVS-57 for TG 1612, TG 2012, TG 2015, TG 2516, TG 3023

182 007 01

Hole cutter

79 mm



Hole cutter

LFR
Through opening: M16-32, drill hole: 16.5-32.5 mm

195 995 01



- 4 basic enclosures up to 600 x 300 mm, with two different cover heights
- **Box:** choice of polystyrene (AKL) or glass-fibre-reinforced polycarbonate, grey, similar to RAL 7035
- **Cover:** grey (polystyrene or polycarbonate) or transparent (polycarbonate)
- Side walls with metric knockouts
- Can be combined up to protection class IP 65 with AK / AKi small distributors from AK 14

IP65

IK07



690V
AC

1000V
DC



IP65

IK08



690V
AC

1000V
DC



Industrial
Quality

Empty enclosures AKL / AKi-L



External brackets ►



External hinges ►



Easy combination ►



Empty enclosures **AKL** / AKi-L

AKL / AKi 1 300 x 150 mm



Base and cover: **Polystyrene**, grey, similar RAL 7035

Enclosure type	Height	Order No.
AKL 1-g	132	740 401 01

Entries end: 15 x M20, 2 x M20/M25, 1 x M32/M40 | Entries on each side: 4 x M20, 1 x M25/M32

Base and cover: **Polycarbonate**, grey, similar RAL 7035

Enclosure type	Height	Order No.
AKi 1-g	132	741 401 01



Base: **Polystyrene**, grey, similar to RAL 7035
Cover: **Polycarbonate**, transparent

Enclosure type	Height	Order No.
AKL 1-t	132	744 001 01

Entries end: 15 x M20, 2 x M20/M25, 1 x M32/M40 | Entries on each side: 4 x M20, 1 x M25/M32

Base: **Polycarbonate**, grey, similar to RAL 7035
Cover: **Polycarbonate**, transparent

Enclosure type	Height	Order No.
AKi 1-t	132	745 001 01

AKL / AKi 2 300 x 300 mm



Base and cover: **Polystyrene**, grey, similar RAL 7035

Enclosure type	Height	Order No.
AKL 2-g	132	740 402 01
AKL 2-gh	209	742 902 01

Entries end: 15 x M20, 2 x M20/M25, 1 x M32/M40 | Entries on each side: 8 x M20, 2 x M25/M32

Base and cover: **Polycarbonate**, grey, similar RAL 7035

Enclosure type	Height	Order No.
AKi 2-g	132	741 402 01
AKi 2-gh	209	743 902 01



Base: **Polystyrene**, grey, similar to RAL 7035
Cover: **Polycarbonate**, transparent

Enclosure type	Height	Order No.
AKL 2-t	132	744 002 01
AKL 2-th	209	746 902 01

Entries end: 15 x M20, 2 x M20/M25, 1 x M32/M40 | Entries on each side: 8 x M20, 2 x M25/M32

Base: **Polycarbonate**, grey, similar to RAL 7035
Cover: **Polycarbonate**, transparent

Enclosure type	Height	Order No.
AKi 2-t	132	745 002 01
AKi 2-th	209	747 902 01

With knockouts

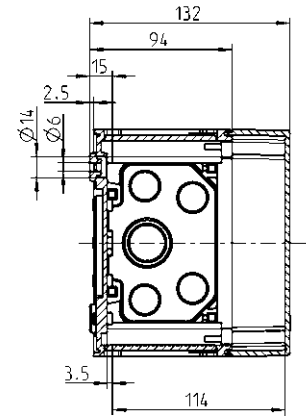
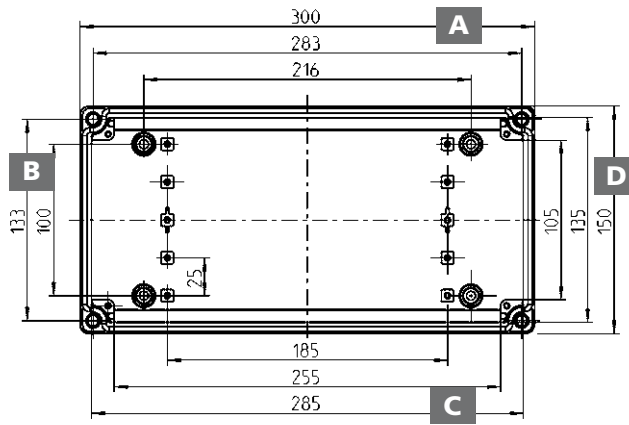
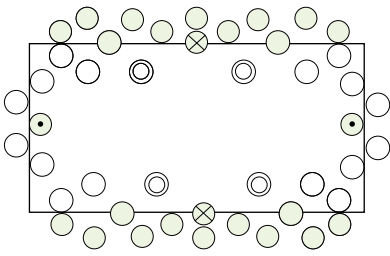

Metric types

- = M 20
- = M 20/25
- ⊙ = M 25/32
- ⊗ = M 32/40

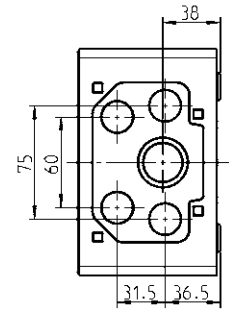
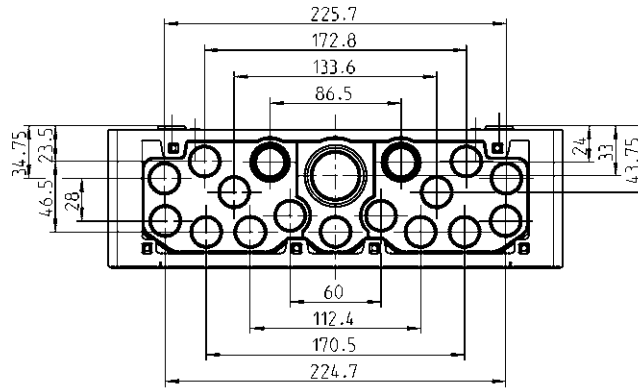

With knockouts

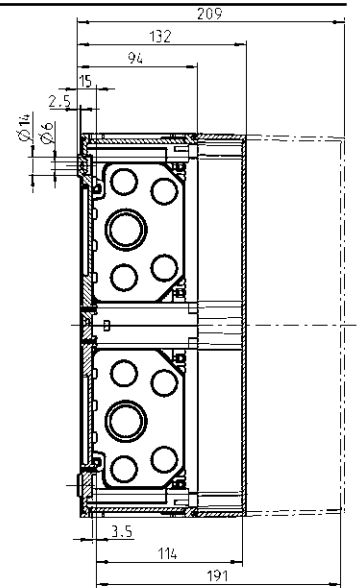
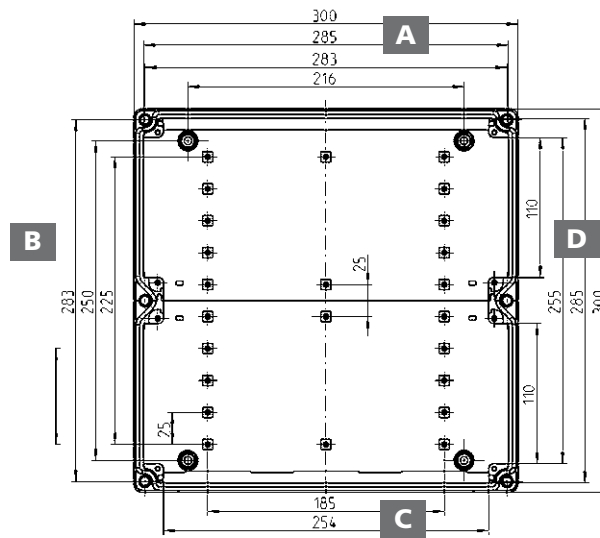
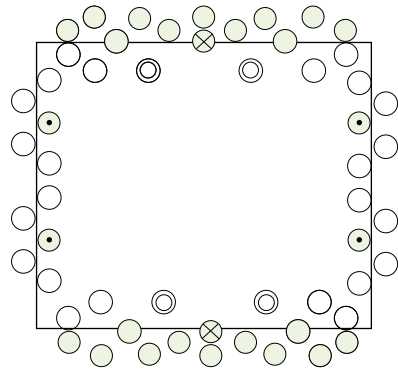

Metric types

- = M 20
- ⊙ = M 20/25
- ⊙ = M 25/32
- ⊗ = M 32/40

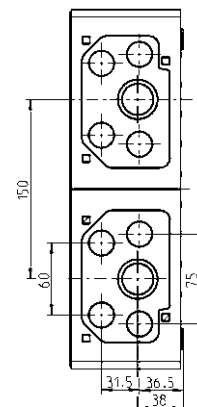
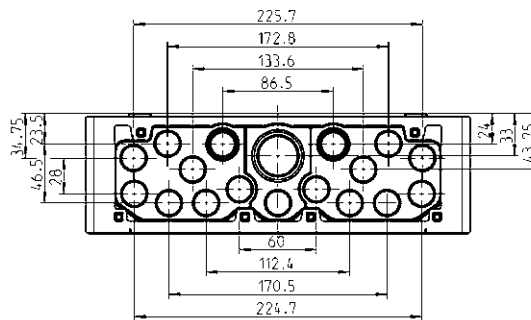

Empty enclosures

AKL / AKi 3 300 x 450 mm



Base and cover: **Polystyrene**, grey, similar RAL 7035

Enclosure type	Height	Order No.
AKL 3-g	132	740 403 01
AKL 3-gh	209	742 903 01

Entries end: 15 x M20, 2 x M20/M25, 1 x M32/M40 | Entries on each side: 12 x M20, 3 x M25/M32

Base and cover: **Polycarbonate**, grey, similar RAL 7035

Enclosure type	Height	Order No.
AKi 3-g	132	741 403 01
AKi 3-gh	209	743 903 01

Base: **Polystyrene**, grey, similar to RAL 7035
Cover: **Polycarbonate**, transparent



Enclosure type	Height	Order No.
AKL 3-t	132	744 003 01
AKL 3-th	209	746 903 01

Entries end: 15 x M20, 2 x M20/M25, 1 x M32/M40 | Entries on each side: 12 x M20, 3 x M25/M32

Base: **Polycarbonate**, grey, similar to RAL 7035
Cover: **Polycarbonate**, transparent

Enclosure type	Height	Order No.
AKi 3-t	132	745 003 01
AKi 3-th	209	747 903 01

AKL / AKi 4 300 x 600 mm



Base and cover: **Polystyrene**, grey, similar RAL 7035

Enclosure type	Height	Order No.
AKL 4-g	132	740 404 01
AKL 4-gh	209	742 904 01

Entries end: 15 x M20, 2 x M20/M25, 1 x M32/M40 | Entries on each side: 16 x M20, 4 x M25/M32

Base and cover: **Polycarbonate**, grey, similar RAL 7035

Enclosure type	Height	Order No.
AKi 4-g	132	741 404 01
AKi 4-gh	209	743 904 01

Base: **Polystyrene**, grey, similar to RAL 7035
Cover: **Polycarbonate**, transparent



Enclosure type	Height	Order No.
AKL 4-t	132	744 004 01
AKL 4-th	209	746 904 01

Entries end: 15 x M20, 2 x M20/M25, 1 x M32/M40 | Entries on each side: 16 x M20, 4 x M25/M32

Base: **Polycarbonate**, grey, similar to RAL 7035
Cover: **Polycarbonate**, transparent

Enclosure type	Height	Order No.
AKi 4-t	132	745 004 01
AKi 4-th	209	747 904 01

With knockouts

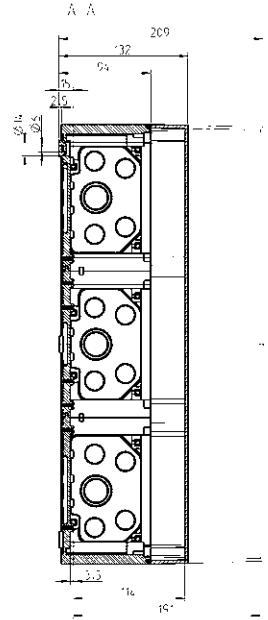
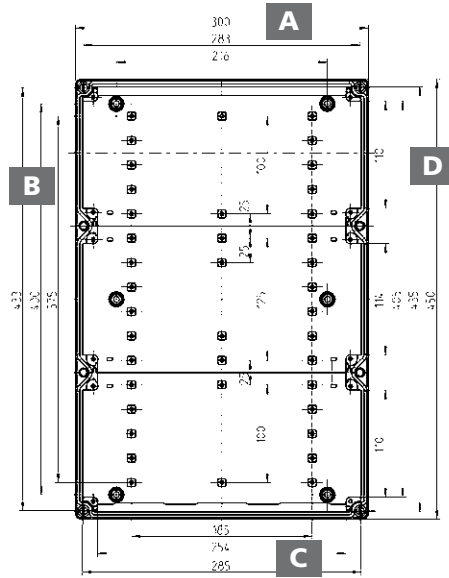
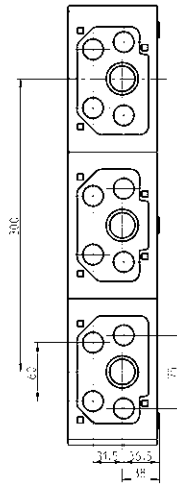
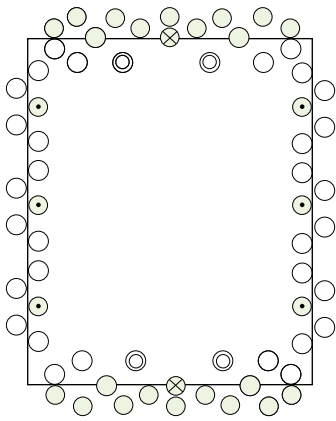

Metric types

- = M 20
- ⊖ = M 20/25
- ⊙ = M 25/32
- ⊗ = M 32/40

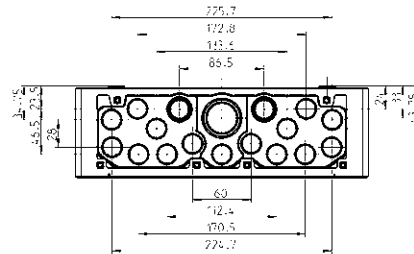

With knockouts

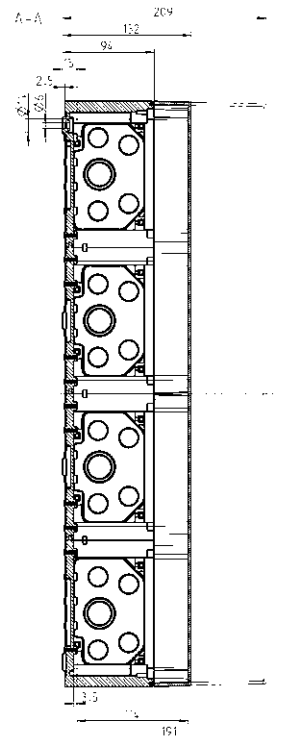
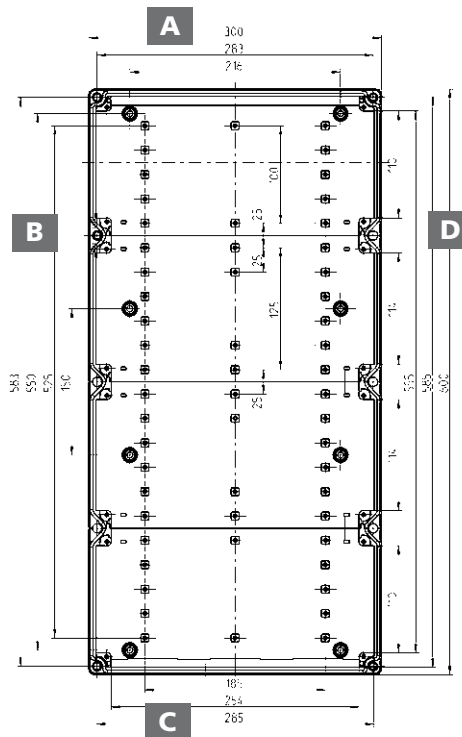
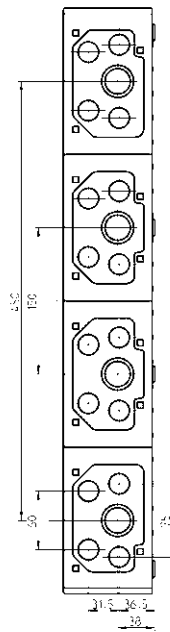
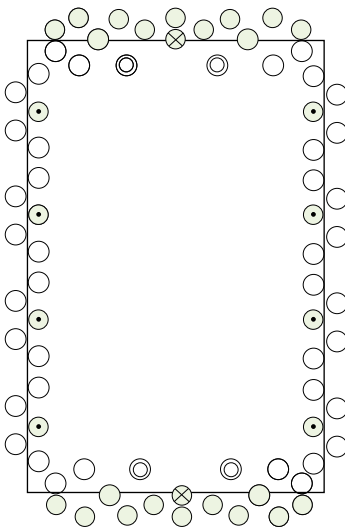

Metric types

- = M 20
- ⊖ = M 20/25
- ⊙ = M 25/32
- ⊗ = M 32/40

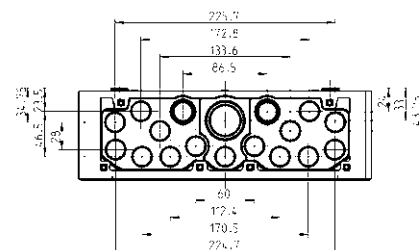

Mounting plate insulating material



Description

Order no.

Mounting plate made from insulating material, incl. fixing screws

	Enclosure type	
AK MPI 1	AKL/AKi 1-4	795 001 01
AK MPI 2	AKL/AKi 2-4	795 002 01
AK MPI 3	AKL/AKi 3-4	795 003 01
AK MPI 4	AKL/AKi 4	795 004 01

Mounting plate stainless steel

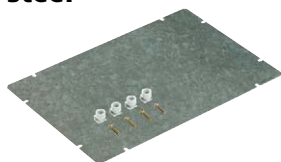

Mounting plate made from stainless steel, incl. fixing screws

	Enclosure type	
AK MPS 2	AKL/AKi 2-4	795 012 01
AK MPS 3	AKL/AKi 3-4	795 013 01
AK MPS 4	AKL/AKi 4	795 014 01

Standard rail NS 35



Standard rail acc. to DIN EN 60715, 35 x 7.5, width 35 mm

AK NS35-250 from 300 x 300 mm, length 250 mm, including spacers		562 735 01
NS35-216/3 universal floor fixing, length 216 mm, with fixing screws		795 030 01
AK NS35-406 universal floor fixing, incl. fixing screws, length 406 mm		795 045 01
AK NS35-556 universal floor fixing, incl. fixing screws, length 556 mm		795 060 01

Support for standard rails



Carrier for standard rails acc. to DIN EN 60715, 35 x 7.5 mm, set = 10 pcs.

	Height	
TR NS35-20	20	795 020 01
TR NS35-34	34,5	795 034 01
TR NS35-42	42,5	795 042 01
TR NS35-58	58,5	795 058 01
TR NS35-64	64	795 064 01
TR NS35-91	91	795 091 01

Carrier NS fixing screws



fixing screws for 1 TR NS35-xx, set of 30 pieces

SR NS35 Fixing screws for 1 support set TR NS35/xx		795 413 01
--	--	------------

KF 12 hinged window

228 x 80 mm



IP65

Description

Hinged window, for fitting to enclosure cover, for maximum 12 distribution units à 17.5 mm, with transparent hinged window, frame with sealing on both sides, with drilling template and fixing screws

Order no.

KF 12

567 412 01

SF 12 inspection window

228 x 80 mm



IP65

Inspection window, for fitting to enclosure cover, transparent inspection glass, with drilling template and fixing screws

SF 12

568 012 01

AK combi set

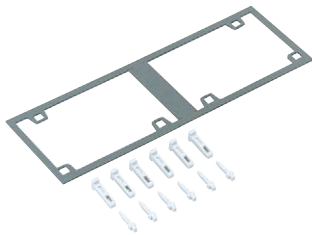

IP65

Combi set, for horizontal or vertical combination of all AK enclosures from 300 x 150 mm, complete with wedge connectors and intermediate sealing for 150 and 300 mm enclosure sides, each 300 mm = 1 combi set

AK KS-IP65

791 001 01

AK combi set



IP30

Combi set without intermediate enclosure seal, for horizontal or vertical combination of all AK enclosures from 300 x 150 mm, 1 set = 10 wedge connectors

AK KS-IP30

591 100 01

Combi connector



IP54

Combi connector, for connecting enclosures, thermoplastic

	f. wall thicknesses/mm	
KST M32	1,5 - 4,0	193 032 01
KST M25-33	1,5 - 4,0	193 026 01
KST M25-17	1,5 - 4,0	193 025 01

Empty enclosures

Combi set



IP66

Description

Order no.

Combi set, for side connection of enclosures with metric entries, complete with lock nuts and intermediate wall seal inserts

	f. wall thicknesses/ mm	Thread length/mm	
KS M20	2 x 3,0	12	192 020 01
KS M25	2 x 3,0	12	192 025 01
KS M25-gro	2,0 x 8,0	22	192 026 01
KS M32	2 x 3,5	14	192 032 01

AK Mounting flange



Enclosure wall, for installation in the components of the AK enclosure system for 300 mm wide end walls, with cable covers as standard

AK ABF 1 with pre-embossing, 2 x M32 / M40 / M50, 1 x M40 / M50 / M63	795 048 01
AK ABF 2 Smooth for self-drilling	795 050 01

AKi Mounting flange



Enclosure wall, for attachment to components of AKi enclosure system to 300 mm wide sides, with cable covers as standard

AKi ABF 1 with pre-embossing, 2 x M32 / M40 / M50, 1 x M40 / M50 / M63	796 051 01
AKi ABF 2 Smooth for self-drilling	796 050 01

Padlock kit



Padlock kit for upgrading the housing cover to lockable hinged door, incl. padlock, 2 hinges, fixing screws, cover plugs and drilling template

VSG from TK PS/PC 1811 onwards and AKL/AKi 1	190 100 01
--	------------

Hinge set



External hinge set for retrofitting the enclosure cover to hinged door, incl. 2 hinges, fixing screws, cover plugs and drilling template

ASS-gro External hinge set large, from TK PS/PC 1811 and from AKL/AKi 1	190 005 01
---	------------

Partition wall



Description

Order no.

Partition wall, for installation in the components of the AK enclosure system, from AK 28 / AKL 2 / AKi 2, universal application for various enclosure heights, with break-out openings, grey

AK TW

797 910 01

AK External attachment set



External fixing lugs, for mounting separate enclosures or small units on flat wall surfaces, can be fixed to the box base at an angle of 0°, 45°, or 90°, wall gap 7 mm, material stainless steel, suitable for all AK enclosures from 300 mm front,

AK ABL-ES
Set = 4 pcs.

793 004 01

Z-wall profile



Z-wall profile, length 2 m, with 8 M6 cylinder screws and 8 captive push nuts, wall clearance 70 mm, material: galvanised steel

ZPR

070 800 01



- 16 standard enclosure sizes up to 330 x 230 mm
- Powder coating to prevent corrosion
- Colour: silver grey, similar to RAL 7001
- Material: Aluminium die-cast
- Effective protection against electromagnetic interference (EMI) and electrostatic discharges (ESD)
- An even higher level of protection can be achieved by using conductive seals (available on request) between the components of the enclosure
- High resistance to chemicals
- Special designs on customer request



Industrial
Quality

Empty enclosures AL

Empty enclosures AL		Dimensions (mm)
Enclosure type	Order No.	
AL 55-3	150 001 01	50 x 45 x 30
AL 66-3	150 002 01	64 x 58 x 34
AL 88-6	150 005 01	80 x 75 x 57
AL 1006-3	150 003 01	98 x 64 x 34
AL 1010-8	150 008 01	100 x 100 x 81
AL 1212-8	150 009 01	122 x 120 x 81
AL 1308-6	150 006 01	125 x 80 x 57
AL 1506-3	150 004 01	150 x 64 x 34
AL 1616-9	150 011 01	160 x 160 x 91
AL 1808-6	150 007 01	175 x 80 x 57
AL 2212-8	150 010 01	220 x 120 x 81
AL 2320-11	150 014 01	230 x 200 x 111
AL 2616-9	150 012 01	260 x 160 x 91
AL 2823-11	150 015 01	280 x 230 x 111
AL 3323-11	150 016 01	330 x 230 x 111
AL 3616-9	150 013 01	360 x 160 x 90



Mounting plate stainless steel



Description

Order no.

Mounting plate made from stainless steel

	Enclosure type	
AL MPS-88	AL 88	155 005 01
AL MPS-1010	AL 1010	155 008 01
AL MPS-1212	AL 1212	155 009 01
AL MPS-1308	AL 1308	155 006 01
AL MPS-1616	AL 1616	155 011 01
AL MPS-1808	AL 1808	155 007 01
AL MPS-2212	AL 2212	155 010 01
AL MPS-2320	AL 2320	155 014 01
AL MPS-2616	AL 2616	155 012 01
AL MPS-2823	AL 2823	155 015 01
AL MPS-3323	AL 3323	155 016 01
AL MPS-3616	AL 3616	155 013 01

Standard rail NS 35



Standard rail acc. to DIN EN 60715, 35 x 7.5, width 35 mm

	Length	Enclosure type	
AL NS35-110	110	AL 1212	162 009 01
AL NS35-145	145	AL 1616	162 011 01
AL NS35-186	186	AL 2320	162 014 01
AL NS35-208	208	AL 2212	162 010 01
AL NS35-245	245	AL 1616	162 012 01
AL NS35-266	266	AL 2823	162 015 01
AL NS35-316	316	AL 3323	162 016 01
AL NS35-345	345	AL 3616	162 013 01

External fixing lugs



Application example

External fixing lugs

AL ALS-kl	for AL/ALR 88, 1006, 1010, 1308, 1506, 1808, for TK AL 77/99	154 004 01
AL ALS-gro	for AL/ALR 1212, 1616, 2212, 2320, 2616, 2823, 3323, 3616, for TK AL 1111, 1313, 1811, 1818, 2518, 3625	154 006 01

External hinge set



For retrofitting the enclosure cover to hinged door. Incl. 2 hinges, fixing screws, masking-off strips and drilling template

AL ASS	for AL/ALR 1010, 1212, 1616, 2212, 2320, 2616, 2823, 3323, 3616, for TK AL 1313, 1811, 1818, 2518, 3625	154 210 01
--------	---	------------

Ventilation seal



IP44

Description

Order no.

With ventilation seal to avoid condensation formation in enclosures, flow rate 100 l/min. at 0.1 bar overpressure, thermoplastic elastomer, grey, recommended for insertion on the left and right enclosure sides in different heights (see Technical Appendix - protection against condensate water)

	f. wall thicknesses/mm	Color	
BST M20	1,5 - 4,5	grey	262 420 01
BST M20/sw	1,5 - 4,5	black	262 020 01

Pressure compensation device



IP68
IP66

Pressure compensation device with air-permeable and watertight special membrane foil to reduce condensation formation in enclosures, flow rate 0.8 l/min. at 0.1 bar overpressure, grey polyamide, without lock nut

DAE M12		262 412 01
M12 x 1.5 mm, Thread length 10 mm		

Double membrane seals



IP66

Double membrane seals made of elastic plastic with two sealing membranes, closed

	f. wall thicknesses/ mm	Sealing area/mm	
DMS M16	1.5 - 4.5	5 - 9	260 416 01
DMS M20	1.5 - 4.5	7 - 12	260 420 01
DMS M25	1.5 - 4.5	9 - 16	260 425 01
DMS M32	1.5 - 4.5	14 - 21	260 432 01
DMS M40	1.5 - 4.5	19 - 28	260 440 01

Cable gland



IP68

Cable gland with strain relief, polyamide, M_x x 1.5 mm, with lock nut

	Thread length/mm	Sealing area/mm	
KVR M12-MGM	8	2 - 6.5	227 412 01
KVR M16-MGM	8	4 - 10,0	227 416 01
KVR M20-MGM	9	6 - 12,0	227 420 01
KVR M20-GDB/MGM	9	7 - 14,0	227 421 01
KVR M25-MGM	11	9 - 16	227 425 01
KVR M32-MGM	11	11 - 21,0	227 432 01
KVR M40-MGM	11	16 - 28,0	227 440 01
KVR M50-MGM	13	21 - 34,5	227 450 01
KVR M63-MGM	17	30 - 44,5	227 463 01

Attachment bushes



IP54

Attachment bushes with open sealing membrane, no lock nuts required

	Sealing area/mm	
AST M16	6 - 10	230 416 01
AST M20	8 - 13,5	230 420 01
AST M25	9 - 18,5	230 425 01
AST M32	13 - 23	230 432 01
AST M40	17 - 30	230 440 01



Application areas

- Stops
- Pumping systems
- Measuring stations
- Telecommunications devices
- Charging stations
- Urban furnishings
- Allotments

Characteristics

- Compact construction
 - For AC connections
- SVi:**
Flexible communication options,
numerous housing variants

Benefits

- No corrosion
- For use in harsh environments
- Easy installation
- Individual adaptation to spatial conditions
- Application-optimised mains connection solutions, quick to implement

IP65
IP54

IK07



400V
AC



iQ

Automatic machine enclosure SVi

238

www.spelsberg.com

Automatic machine enclosure - Industrial Quality -
1x PE/N terminal (2x (1 x 25 mm² + 7 x 4(6) mm²))

IP65

400V
AC

IK07

**SVi A 6**

150 x 300 x 156 mm

**SVi A 6**

1-row, 6 distribution units,
arranged at the top, with hinged window

591 061 01

SVi A 2x6

150 x 300 x 156 mm

**SVi A 2x6**

2-row, 2 x 6 distribution units,
with hinged window

591 064 01

SVi A 12

300 x 150 x 156 mm

**SVi A 12**

1-row, 12 distribution units,
with hinged window

591 132 01

SVi L
150 x 300 mm



Description

Order no.

Empty Enclosure - Industrial Quality,
for individual expansion with standard rails or mounting plates



	Height mm	
SVi L-g	137	591 120 01
SVi L-gh	162	591 121 01
SVi L-t	137	591 110 01
SVi L-th	162	591 112 01

SVi LQ
150 x 150 x 137 mm



Empty Enclosure - Industrial Quality,
for individual expansion with standard rails



SVi LQ-t	591 210 01
Protective insulation, box + lid polycarbonate, box grey, simil. RAL 7035, cover transparent	
SVi LQ-g	591 220 01
Protective insulation, box + lid polycarbonate, grey, simil. RAL 7035	

SVi LS
150 x 300 mm



Empty Enclosure - Industrial Quality, with sliding seal and cable clamp



SVi LS-g	591 122 01
SVi LS-gh	591 123 01
SVi LS-t	591 113 01
SVi LS-th	591 114 01

Support for standard rails



Description

Order no.

Carrier for standard rails acc. to DIN EN 60715, 35 x 7.5 mm, Set = 10 pcs.

	Height	
TR NS35-20	20	795 020 01
TR NS35-34	34,5	795 034 01
TR NS35-42	42,5	795 042 01
TR NS35-58	58,5	795 058 01
TR NS35-64	64	795 064 01
TR NS35-91	91	795 091 01

Carrier NS fixing screws



fixing screws for 1 TR NS35-xx, set of 30 pieces

SR NS35 Fixing screws for 1 support set TR NS35/xx	795 413 01
--	------------

Mounting plate insulating material



Mounting plate made from insulating material, incl. fixing screws

	Enclosure type	
SVI MPI	SVi-L	591 900 01

Standard rail NS 35



Standard rail acc. to DIN EN 60715, 35 x 7.5, width 35 mm, incl. fixing screws

	Enclosure type	
NS35-125	SVi-L/SVi A 6	591 906 01
NS35-260	SVi-L	591 912 01

Empty enclosures



As solid as concrete – our IBT enclosures for concrete installation. With the IBTronic XL system, you have many choices for installation in all kinds of spaces thanks to integrated Fermacell® plasterboard. And without the need for lengthy, tedious planning.

Concrete Installation

	Types	Pages
	Junction boxes for concrete construction IBT	244-256
	The reinforcement box - Installation solutions for architectural concrete IBT	248-249
	Junction boxes for lightweight concrete construction IBT	257-260
	Junction boxes for Export versions IBT	259-260
	Accessories for IBT	262-267
	Luminaire housings for sitecast concrete and precast concrete construction IBTronic	268-270
	Universal mounting enclosure IBT LED for installing NV/HV/LED luminaires and loudspeakers	272-273
	Luminaire housings for precast concrete construction IBTronic XL	274-275
	For subsequent installation in prefabricated ceilings IBTronic XL Drillbox	276-279

NEW!

U 71 FD flat box

71 x 71 x 38 mm, Ø 60 mm



Entries:
2 x to 20 mm Ø

Description

Order no.

Flat box for installation in concrete, flat construction type for extremely thin walls, 2 screw bosses with 60 mm screw spacing, combinable with normal 71 mm spacing, fully insulated cable transition, suitable for all types of formwork and opposing formwork



U 71 FD with smooth face for nail and adhesive fixing	971 035 01
Accessories	
VD 75, Sealing cap	979 100 01

U 71 GRD receptacle

71 x 71 x 50 mm (U 71 GRD-D=45 mm),
Ø 60 mm



Entries:
2 x to 25 mm Ø
U71 GRD-D: 2 x up to 20 mm Ø

Receptacle for installation in concrete, 2-part, 2 screw bosses with 60 mm screw spacing, combinable with normal 71 mm spacing, fully insulated cable transition, suitable for all types of formwork and opposing formwork, VDE certified as per DIN EN 60670 (VDE 0606)



U 71 GRD for nail and magnet installation	971 045 01
U 71 K GRD with smooth face for nail and adhesive fixing	971 745 01
U 71 GRD-D receptacle for extremely thin walls, only 45 mm deep, for nail and magnet installation, can be combined with corresponding interconnection frame	971 045 02
Accessories	
VD 75, Sealing cap	979 100 01

U 71 KUD dome box

71 x 71 x 91 mm,
Ø 60 mm



Entries:
4 x to 25 mm Ø, 45°
2 x to 25 mm Ø

Dome box for installation in concrete, 2-part, also usable as a ceiling socket, 2 screw bosses with 60 mm screw spacing, combinable with normal 71 mm spacing, fully insulated cable transition, suitable for all types of formwork and opposing formwork



U 71 KUD Ffor nail and magnet installation	971 047 01
U 71 KUD-M5 with M5 threaded bush to take a ceiling hook (979 122 01), for nail and magnet installation	971 248 01
Accessories	
DH 90 Ceiling hook, length 90 mm	979 116 01
VD 75, Sealing cap	979 100 01
DH 90-M5, Ceiling hook	979 122 01

U 71 GVD-2 branch socket

2-piece

71 x 71 x 68 mm, Ø 60 mm



Entries:
6 x to 25 mm Ø
2 x to 20 mm Ø

Description

Order no.

Equipment junction box for installation in concrete, 2-part, with enlarged connection space, 4 screw bosses with 60 mm screw spacing, combinable with normal 71 mm spacing, fully insulated cable transition, suitable for all types of formwork and opposing formwork, VDE certified as per DIN EN 60670 (VDE 0606)

IP30



90°C



U 71 GVD-2
for nail and magnet installation

971 065 01

U 71 K GVD-2
with smooth face for nail and adhesive fixing

971 765 01

Accessories

VD 75, Sealing cap

979 100 01

U 71 GVD-3 branch socket

3-piece

71 x 71 x 68 mm, Ø 60 mm



Entries:
6 x to 25 mm Ø
2 x to 20 mm Ø

Equipment junction box for installation in concrete in component factories, 3-part, 4 screw bosses with 60 mm screw spacing, combinable with normal 71 mm spacing, fully insulated cable transition, suitable for all types of formwork and opposing formwork, VDE certified as per DIN EN 60670 (VDE 0606)

IP30



90°C



U 71 GVD-3
for nail and magnet installation

971 365 01

U 71 K GVD-3
with smooth face for nail and adhesive fixing

971 865 01

Accessories

VD 75, Sealing cap

979 100 01

U 71 GRO large conduit box

71 x 71 x 76 mm, Ø 60 mm



Entries:
4 x to 37 mm Ø

Large conduit box for installation in concrete, 2-part, 4 screw bosses with 60 mm screw spacing, combinable with normal 71 mm spacing, fully insulated cable transition, suitable for all types of formwork and opposing formwork, VDE certified as per DIN EN 60670 (VDE 0606)

IP30



90°C



U 71 GRO
for nail and magnet installation

972 960 01

U 71 K GRO
with smooth face for nail and adhesive fixing

972 760 01

Accessories

VD 75, Sealing cap

979 100 01

U 71 TD deep box

71 x 71 x 49 mm, Ø 60 mm



Entries:
972 945 01:
4 x to 32 mm Ø
972 925 01:
6 x to 25 mm Ø
2 x to 20 mm Ø

Description

Order no.

Deep box for installation in concrete, as top enclosure for all U 71 boxes when using large conduits, screw spacing 60 mm



U 71 TD-44
deep box M25, 44 mm deep

972 925 01

U 71 TD-49
deep box M32, 49 mm deep

972 945 01

Accessories

U 71 KP-M5, dome with threaded bush

971 748 01

GWD, threaded base M5

979 110 01

U 71 BSK-K, blank base for adhesive fixing

979 538 01

U 71 BSK, blank base for magnet fixing

979 539 01

WAD wall outlet box

71 x 71 x 48 mm, Ø 35 mm



Entries:
2 x to 20 mm Ø

Wall outlet box for installation in concrete, for connecting wall luminaires acc. to VDE 0100, with screwed hole for light fixing, combinable, front outlet of 35 mm



WAD
suitable for opposing formwork

970 560 01

Accessories

WAD VD
Sealing cover white, 35 mm Ø, outlet cover

970 562 01

U 71 DAD ceiling luminaire junction box

71 x 71 mm, Ø 35 mm



Entries:
971 548 01
4 x to 25 mm Ø, 45°
2 x to 20 mm Ø
971 549 01
6 x to 25 mm Ø
4 x to 20 mm Ø

Ceiling luminaire junction box for installation in concrete, combinable, front outlet of 35 mm, VDE certified as per DIN EN 60670 (VDE 0606)



U 71 DAD
2-part, suitable for opposing formwork, 89 mm high,
rearward dome with M5 threaded bushing to take a ceiling hook

971 548 01

U 71 DAD-3
3-part, suitable for opposing formwork, 106 mm high,
with M5 threaded bushing to take a ceiling hook

971 549 01

Accessories

WAD VD, Sealing cap

970 562 01

DH 90-M5, Ceiling hook

979 122 01

DH 100-M5, Ceiling hook

979 119 01

U 71 Perilex® receptacle

71 x 71 x 50 mm, Ø 70 mm



Entries:
6 x to 22.5 mm Ø

Description

Order no.

Perilex® receptacle for installation in concrete, 2-part, 67 mm screw spacing, for Perilex® inserts 16 A, FR-UP equipment, CEE sockets 5-pole 16 A

IP30



90°C



U 71 Perilex
suitable for opposing formwork, For nail and magnet installation

973 050 01

Accessories
VD 75, Sealing cap

979 100 01

U 71 DGR ceiling large conduit box

71 x 71 x 89 mm, Ø 60 mm



Entries:
4 x to 37 mm Ø

U 71 DGR cover large conduit box, for installation in concrete, in two parts, diameter 60 mm Ø, 4 screw bosses with a 60 mm screw spacing, combinable, with M5 threaded bushing to take a ceiling hook, suitable for opposing formwork

IP30



90°C



U 71 DGR
with smooth face for nail and adhesive fixing

972 770 01

Accessories
DH 90-M5, Ceiling hook
DH 100-M5, Ceiling hook

979 122 01

979 119 01

U 71 DVD ceiling junction box

71 x 71 x 79 mm /81, Ø 60 mm



Entries:
6 x to 25 mm Ø
2 x to 20 mm Ø

Ceiling connection box for installation in concrete, 4 screw bosses with 60 mm screw spacing, with M5 threaded bush to take a ceiling hook, combinable with a standard spacing of 71 mm, fully insulated cable transition, suitable for opposing formwork, VDE certified as per DIN EN 60670 (VDE 0606)

IP30



90°C



U 71 DVD-2
2-part, for nail and magnet installation

971 066 01

U 71 K DVD-2
2-part, with smooth face for nail and adhesive fixing

971 766 01

U 71 K DVD-3
3-part, with smooth face for nail and adhesive fixing

971 866 01

Accessories
VD 75, Sealing cap
DH 75, Ceiling hook

979 100 01

979 117 01



Installation solutions for exposed concrete

The visible face of exposed concrete is a reflection of the formwork surface. Perfect surfaces with installation material: The innovative reinforcement box enables a perfect electrical installation within exposed concrete surfaces, without causing damage to the formwork surfaces.

Patented spring technology

The patented spring system of the reinforcement box compensates for different depths of concrete cover over the reinforcement and ensures optimum pressure on the formwork. The reinforcement box precisely adapts to every wall thickness like a shock absorber and guarantees an exact fit in the exposed concrete wall.



The reinforcement box - reveals the best side of exposed concrete

U 71 reinforcement adapter

300 x 76 x 35 mm



Description

Order no.

Reinforcement adapter for the support of all U71 sockets (except for Perilex), combinable with a standard spacing of 71 mm, face concrete for the opposing formwork without support with preinstallation in the reinforcement for the concrete construction



IBT BWA

979 330 01

U71 reinforcement box

300 x 76 mm

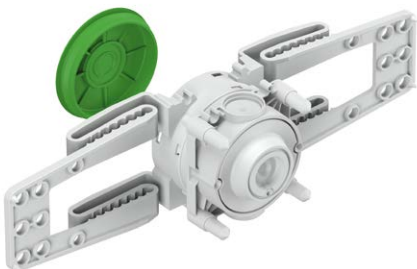

Reinforcement box, in two parts, green rearward base with max. 1 x 25 mm insert , combinable, Suitable for opposing formwork without support, pre-installation in the reinforcement bars, for concrete installation, combinable with a standard spacing of 71 mm



U 71 BWD WAD-35

height 65mm, 35 mm Ø Discharge at the front, Entries: 2 x to 20 mm Ø, concrete cover for the reinforcement of 20-40 mm, for connecting wall lights according to VDE 0100, with screw hole for light fitting

970 160 01

U 71 BWD GVD-2-60

height 85mm, 60 mm Ø Discharge at the front, entries: 6 x to 25 mm Ø, 2 x to 20 mm Ø, concrete cover for the reinforcement of 20-60 mm, VDE certified as per DIN EN 60670 (VDE 0606)

971 165 01

Concrete Installation

U 86 DVD universal ceiling socket

106 mm Height, Ø 74/92 mm



Entries:
8 x to 26 mm Ø

Description

Order no.

Universal ceiling socket for installation in concrete, for slab ceilings up to 4.5 cm thick, with M5 threaded bush to take a ceiling hook, VDE certified as per DIN EN 60670 (VDE 0606)



U 86 DVD-2 2-part, For nail and magnet installation	973 081 02
U 86 K DVD-2 2-part, with smooth face for nail and adhesive fixing	973 781 01
U 86 K DVD-3 3-part, with smooth face for nail and adhesive fixing	973 783 01
Accessories	
VD 75, Sealing cap	979 100 01
HD VD 67, Sealing cap	925 100 01
DH 100-M5, Ceiling hook	979 119 01

U 120 GRO large conduit ceiling socket

122 mm Height, Ø 80/92 mm



Entries:
4 x to 35 mm Ø
8 x to 26 mm Ø

Large conduit ceiling socket for installation in concrete, for slab ceilings up to 6.5 cm thickness, with M5 threaded bush to take a ceiling hook



U 120 GRO-3 3-part, for nail and magnet installation	973 312 01
U 120 K GRO-3 3-part, with smooth face for nail and adhesive fixing	973 713 01
U 120 K GRO-2 in two parts, with smooth face for nail and adhesive fixing	973 712 01
Accessories	
VD 75, Sealing cap	979 100 01
HD VD 67, Sealing cap	925 100 01
DH 115-M5, Ceiling hook	979 121 01

ROP conduit ferrule



Conduit ferrule for installation in concrete with bottom section, to take various conduit diameters



ROP 20 hole 18 Ø, for conduit type M20, external pipe diameter 20 mm, suitable for opposing formwork	970 518 01
ROP 25 hole 23 mm Ø, for conduit type M25, external diameter 25 mm, suitable for opposing formwork	970 523 01
ROP 32 hole 30 mm Ø, for conduit type M32, external diameter Ø 32 mm, suitable for opposing formwork	970 530 01
ROP 40 hole 37 mm Ø, for conduit type M40, external diameter Ø 40 mm	970 537 01

ROK conduit elbow



Conduit elbow for 30° insert to insert into conduit ferrule



ROK 1 30° small for conduit ferrule 970 518 01, M20	970 425 01
ROK 2 30° average for conduit ferrule 970 523 01, M25	970 430 01
ROK 3 30° large for conduit ferrule 970 530 01, M32	970 435 01
Accessories DH 55, Ceiling hook	979 115 01

ROK conduit ferrule/Conduit elbow set



Conduit ferrule / conduit elbow for installation in concrete, 3-part, consisting of conduit ferrule with bottom section and conduit elbow 30°



ROK 20 S for conduit type M20	970 720 01
ROK 25 S for conduit type M25	970 725 01
ROK 32 S for conduit type M32	970 732 01

KOT cone funnel



Cone funnel for installation in concrete for wall-to-wall connection in large panel constructions and for connections from risers (e.g. telephone TV) also suitable for magnet fixing and opposing formwork



KOT 20 71 x 71 x 87 mm, hole Ø 18 mm, for conduit type M20	970 618 01
KOT 25 71 x 71 x 112 mm, hole Ø 23 mm, for conduit type M25	970 623 01
KOT 32 71 x 71 x 112 mm, hole Ø 30 mm, for conduit type M32	970 630 01
KOT 40 71 x 71 x 112 mm, hole Ø 37 mm, for conduit type M40	970 637 01

KUT dome funnel

71 x 71 x 62 mm /64, Ø 60 mm



Entries:
4 x to 25 mm Ø, 45°

Description

Order no.

Dome funnel for installation in concrete, 2-part, as a ceiling outlet for internal partition or as luminaire outlet, combinable with normal 71 mm spacing, with smooth face for nail and adhesive fixing, suitable for opposing formwork



U 71 KUT	970 540 01
U 71 KUT-M5 with M5 threaded bush	970 748 01
Accessories	
DH 65-M5, Ceiling hook with M5 thread	979 120 0x

KUK dome box

90 x 40 x 55 mm



Entries:
10 x up to 22.5 mm Ø

As a dome box for installation in concrete as ceiling outlet in cast-in-place concrete or large panel construction



KUK As a wall-ceiling connection in large panel construction	970 550 01
--	------------

VBK connection box

95 x 90 x 50 mm



Entries:
3 x to 28.3 mm Ø

Junction box for installation in concrete
as a wall/ceiling transfer in large panel construction



VBK As a wall junction box in cast-in-place concrete	970 690 01
Accessories	
VD 75, Sealing cap	979 100 0x

DAL universal outlet cleats



Description

Order no.

Universal outlet cleats for installation in concrete, usable as a ceiling outlet with a large tolerance compensation, DAL 1 and DAL 2 can be combined next to each other and one behind the other without tools



DAL 1 for conduits M20, M25 (171 x 49 x 35 mm)	970 705 01
DAL 2 for conduits M25 (171 x 49 x 35 mm)	970 706 01
DAL 4 for conduits M32, M40 (315 x 80 x 90 mm), reusable	970 704 01

VST Sealing plug



Blanking plugs with closed diaphragm are needed when DAL 1 / DAL 2 are combined one behind the other, for wall thickness 1.5 - 4.0 mm



	Sealing area/mm	
VST M20-or	8 - 13.5	231 620 01
VST M25-or	9 - 16	231 625 01
VST M32-or	13 - 23	231 632 01
VST M40-or	17 - 30	231 640 01

UVA universal outlet 90°

126 x 86 x 57 mm



Universal outlet for installation in concrete, for easy conduit transfer in the wall and ceiling area or for continuing conduits under the screed, entries for conduits up to M25, suitable for adhesive fixing and opposing shuttering



UVA 90 Universal outlet 90°, (support spar technology= wall thickness minus 2 cm)	970 716 01
Accessories	
RVB 20, Conduit connector M20	970 220 01
RVB 25, Conduit connector M25	970 225 01
U 71 BSK-K, blank base for adhesive fixing	979 538 01
U 71 BSK, blank base for magnet fixing	979 539 01

Top entries:
1 x M20/M25
Back entries:
1 x M20/M25

Concrete Installation

K0 EK mounting box

111 x 71 x 61 mm

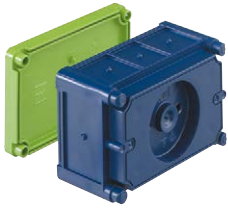

Entries:
6 x up to 32 mm Ø
2 x to 25 mm Ø

Description

Order no.

Mounting box for installation in concrete, suitable as a junction box, screw spacing 83.5 mm (3 9/32 inch) and 100 mm, complies with AFI standard, for installing "American Standard 432", equipment per NEMA Publ. NO.OS 1, combinable

IP30



90°C



K0 EK

suitable for opposing formwork, for nail and magnet installation

977 001 01

Accessories

K0 VD, Sealing cap for K0 EK

977 100 01

K0 K15 BL, 2 blank cleats per box required

979 532 01

K15 EK mounting box

116 x 111 x 61 mm



Entries:
8 x to 32 mm Ø
4 x to 25 mm Ø

Mounting box for installation in concrete, suitable as a junction box with large terminal space, screw spacing 2 x 83.5 mm (3 9/32 inch) and 1 x 100 mm, complies with AFI standard, mounting box for installation in concrete, for installing "American Standard", equipment acc. to NEMA Publ. NO.OS 1, corresponds to the »'4" square box« for 2 units, screw spacing 2 x 83.5 mm (3 9/32 inch.), combinable

IP30



90°C



K15 EK

suitable for opposing formwork, for nail and magnet installation

977 002 01

Accessories

K15 VD, Sealing cap K15 EK

977 105 01

K0 K15 BL, 2 blank cleats per box required

979 532 01

K1 EK mounting box

85 x 91 x 53 mm



Entries:
6 x to 23 mm Ø

Mounting box for installation in concrete, suitable as a junction box or mounting box for Zettler light call E1

IP30



90°C



K1 EK

suitable for opposing formwork, for nail and magnet installation

975 001 01

Accessories

K1 VD, Sealing cap for K1 EK

975 100 01

K0 K15 BL, 2 blank cleats per box required

979 532 01

K2 EK mounting box

91 x 149 x 53 mm



Entries:
10 x up to 23 mm Ø

Description

Order no.

Mounting box for installation in concrete, suitable as a junction box or mounting box for Zettler light call E2 or for diverse intercom systems

IP30



90°C



K2 EK
suitable for opposing formwork, for nail and magnet installation

975 002 01

Accessories

K2 VD, Sealing cap for K2 EK
9795310x

975 102 01

979 531 01

K3 EK mounting box

142 x 142 x 70 mm

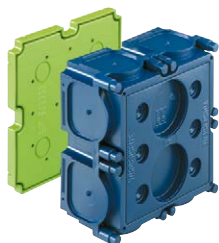

Entries:
8 x to 47.5 mm Ø

Mounting box for installation in concrete, prepared to take the WK terminal blocks 2.5 - 25 mm², suitable to take a 20-pole telephone terminal strip or as a telephone continuity box to DIN 47614-615, combinable

IP30



90°C



K3 EK
suitable for opposing formwork, for nail and magnet installation

980 002 01

Accessories

K3 VD, Sealing cap for K3 EK
K3 TW, partition panel for K3 EK

980 100 01

980 105 01

K4 EK mounting box

311 x 202 x 87 mm



Entries:
16 x to 47.5 mm Ø

Mounting box for installation in concrete, prepared to take the WK terminal blocks 2.5 - 25 mm², suitable to take a 40-pole telephone terminal strip, as a telephone continuity box acc. to DIN 47614-615 or IBT distribution set UP 015 (1-row, 15 distribution units), combinable

IP30



90°C



K4 EK
suitable for opposing formwork, for nail and magnet installation

980 004 01

Accessories

K4 VD, Sealing cap for K4 EK

980 104 01

K4 - H EK mounting box

311 x 202 x 158 mm / 171



Entries:
32 x to 47.5 mm Ø

Description

Order no.

Mounting box for installation in concrete, prepared to take the WK terminal blocks 2.5 – 25 mm², suitable to take a 40-pole telephone terminal strip, as a telephone continuity box acc. to DIN 47614-615 or IBT distribution set UP 015 (1-row, 15 distribution units), halogen-free, for installing NV/HV/LED luminaires and loudspeakers.

IP30



90°C



K4-H EK

suitable for opposing formwork, for nail and magnet installation, without Fermacell® plasterboard, Lamp output max. 50W/LED 40W

980 005 01

K4-H-P EK

Fermacell® plasterboard with recess (max. load-bearing capacity 10 kg), variable to max. 220 x 150 mm, max. installation height LV lights: 130 mm, HV lights: 135 mm, electronic transformer up to max. 150 VA, lamp output max. 50W/LED 40W

980 006 01

Accessories

K4 VD, Sealing cap for K4 EK

980 104 01

UP 015 – Distributor kit

311 x 202 x 87 mm



90°C



UP 015

for installation box K4 EK

986 000 01



◀ Can be combined tool-free at standard spacing of 71 mm

- Universal mounting options (front part smooth, open and with embossing)
- Box for mounting devices on both sides (100 mm wall thickness)

Boxes for wall thicknesses in excess of 100 mm were developed specially for the lightweight concrete industry to satisfy the special requirements of its production techniques.

Crack formation in lightweight concrete walls is now a thing of the past! The new lightweight concrete boxes from Spelsberg have deep-set conduit entries up to 4 x M25 / M32. The concrete cover of up to 37 mm ensures **crack-free walls**.

Different fronts ensure shorter installation times and reduced installation costs.



Concrete Installation IBT Junction boxes for lightweight concrete



LB 71 GVD 86

71 x 71 x 86 mm Height, Ø 60 mm



Entries:
4 x to 32 mm Ø

Description

Order no.

Equipment junction box for installation in concrete, 2-part, universal socket with large interior space, 4 screw bosses with 60 mm screw spacing, combinable with a standard spacing of 71 mm, fully insulated cable transition

IP30



90°C



LB 71 M GVD 86

for nail and magnet installation

981 084 01

LB 71 K GVD 86

with smooth face for nail and adhesive fixing

981 784 01

LB 71 O GVD 86

suitable for use in form work table

981 884 01

LB 71 GVD 100

71 x 71 x 100 mm Height, Ø 60 mm



Entries:
4 x to 32 mm Ø

Equipment junction box for installation in concrete, 2-part, universal socket for mounting the devices on both sides with large interior space, 4 screw bosses with 60 mm screw spacing, combinable with a standard spacing of 71 mm, fully insulated cable transition

IP30



90°C



LB 71 M GVD 100

for nail and magnet installation

981 010 01

LB 71 K GVD 100

with smooth face for nail and adhesive fixing

981 710 01

LB 71 O GVD 100

suitable for use in form work table

981 810 01

BS 1 equipment installation box

86 x 86 x 60 mm



Entries:
8 x to 32 mm Ø

Description

Order no.

Equipment installation box for installation in concrete, "1-way box" for installing "British Standard" equipment, screw spacing 60.3 mm (2³/₈ inch.), delivered with earthing screw

IP30



90°C



BS 1

suitable for opposing formwork, for nail and magnet installation

974 001 01

Accessories

BS 1-BSK

86 x 86 x 25 mm

974 431 01

BS MBR

2 pcs. required per box

974 120 01

BS ES-30

3.5 x 30 mm

974 130 01

BS ES-40

3.5 x 40 mm

974 135 01

BS ES-50

3.5 x 50 mm

974 150 01

BS 1 VD

for equipment installation box BS 1, 86 x 86 mm

974 100 01

BS 2 equipment installation box

146 x 86 x 60 mm



Entries:
10 x up to 32 mm Ø

Equipment installation box for installation in concrete, "2-way box" for installing "British Standard" equipment, screw spacing 120.6 mm (4³/₄ inch.), delivered with earthing screw

IP30



90°C



BS 2

suitable for opposing formwork, for nail and magnet installation

974 002 01

Accessories

BS 2-BSK

146 x 86 x 25 mm

974 432 01

BS MBR

2 pcs. required per box

974 120 01

BS ES-30

3.5 x 30 mm

974 130 01

BS ES-40

3.5 x 40 mm

974 135 01

BS ES-50

3.5 x 50 mm

974 150 01

BS 2 VD

for equipment installation box BS 2, 146 x 86 mm

974 102 01

Concrete Installation

K0 EK mounting box

111 x 71 x 61 mm

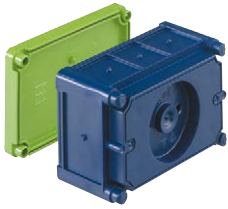

Entries:

6 x up to 32 mm Ø
2 x to 25 mm Ø

Description

Order no.

Mounting box for installation in concrete, suitable as a junction box, screw spacing 83.5 mm (3 9/32 inch) and 100 mm, complies with AFI standard, for installing "American Standard 432", equipment per NEMA Publ. NO.OS 1, combinable

IP30



90°C



K0 EK

suitable for opposing formwork, for nail and magnet installation

977 001 01

Accessories

K0 VD, Sealing cap for K0 EK

977 100 01

K0 K15 BL, 2 blank cleats per box required

979 532 01

K15 EK mounting box

116 x 111 x 61 mm



Entries:

8 x to 32 mm Ø
4 x to 25 mm Ø

Mounting box for installation in concrete, suitable as a junction box with large terminal space, screw spacing 2 x 83.5 mm (3 9/32 inch) and 1 x 100 mm, complies with AFI standard, mounting box for installation in concrete, for installing "American Standard", equipment acc. to NEMA Publ. NO.OS 1, corresponds to the »'4" square box« for 2 units, screw spacing 2 x 83.5 mm (3 9/32 inch.), combinable

IP30



90°C



K15 EK

suitable for opposing formwork, for nail and magnet installation

977 002 01

Accessories

K15 VD, Sealing cap K15 EK

977 105 01

K0 K15 BL, 2 blank cleats per box required

979 532 01

Terminal block

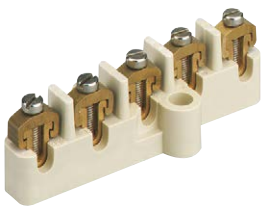

Terminal blocks, for installation in IBT mounting boxes

Abox 025/040 KLS-2,5²/4²

5x2.5/4 mm², for K0-, K15, K1-, K2-EK boxes

840 004 01

WK 060 KLS-6²

5x6 mm², for K15, K2-, K3-EK boxes

460 506 01

WK 100 KLS-10²

5x10 mm², for K15, K3-, K4-EK boxes

460 510 01

WK 160 KLS-16²

5x16 mm², for K3-, K4-EK boxes

460 516 01

WK 250 KLS-25²

5x25 mm², for K4-EK boxes

460 535 01

IBT ST plugs



Description

Order no.

IBT plug

IBT ST
protects the screw bosses from ingress of concrete

979 205 01

GWB threaded base M5

15 mm Height



Threaded base M5

GWB
With M5 threaded bushing to take a ceiling hook, converts every U71 junction box to a ceiling socket

979 110 01

U 71 KP dome

43 mm Height



Dome with threaded bush M5, suitable as an attachment for U 71 boxes as well as magnet and adhesive blank bases

U 71 KP-M5
(suitable for series U 71)

971 748 01

Accessories for combinations



Interconnection frames for the combination of boxes under extreme loading

VB 71
for a spacing 71 mm

979 212 01

VB 80/85
for a spacing 80 and 85 mm

979 213 01

VB 90
for a spacing 90 mm

979 214 01

VB 105
for a spacing 105 mm

979 215 01

Accessories for combinations



Compound nipple as a seal and cable routing duct for a spacing of 71 mm

VBN
(for U 71 receptacle 971 045 02)

979 210 01

VD sealing cap



Description

Order no.

Sealing cap, white, flame retardant, for special boxes

	Enclosure type		
K0 VD	K0 EK		977 100 01
K1 VD	K15 EK		975 100 01
K2 VD	K1 EK		975 102 01
K3 VD	K2 EK		980 100 01
K4 VD	K3 EK		980 104 01
K15 VD	K4 EK		977 105 01

VD sealing cap



Sealing cap for junction boxes, flame resistant, white

	Diameter	Enclosure type	
VD 75	75 mm	U71, U86, U120	979 100 01
HW VD-60	90 mm	U71	925 101 01
HW VD-67	90 mm	U86, U120	925 100 01
U 71 VDF	80 mm	U71	979 102 01
U 86 VDF	90 mm	U86	979 103 01
U 71 VDS	80 mm	U71	979 104 01

BS VD sealing cap



Sealing cap BS, white, flame-retardant, with fixing screws and assembly bridges

BS 1 VD for equipment installation box BS 1, 86 x 86 mm	974 100 01
BS 2 VD for equipment installation box BS 2, 146 x 86 mm	974 102 01

DH ceiling hook



Ceiling hook, insulated, with wood screw thread

	Shaft length	Enclosure type	
DH 55	55	ROK 1	979 115 01
DH 65	65	U 71 KUT	979 118 01
DH 90	90	U 71 KUD	979 116 01

DH ceiling hook



Ceiling hook, insulated, with M5 thread

	Enclosure type	Shaft length	
DH 65-M5	U 71 KUT-M5	65	979 120 01
DH 75-M5	U 71 KUD-M5	75	979 117 01
DH 90-M5	U 71 KUD-M5	90	979 122 01
DH 100-M5	U 86 DVD-2	100	979 119 01
DH 115-M5	U 120 GRO-3	115	979 121 01
DH 135-M5	U 71 KUT-M5	135	979 123 01

U 71 blank base BSK

71 x 71 x 25 mm / 21



Description

Order no.

Blank base, base for supporting IBT boxes and boxes in opposing formwork in conjunction with support spars, can be combined via snap-in connection, if fitting the blank base using nails, magnet, adhesive, the fixing points must be plastered subsequently, for fitting:
1. the U 71 boxes in opposing formwork, at a 71 mm spacing, can also be combined with interconnecting frame for extreme loading, 2. the mounting boxes K3 EK and K4 EK with opposing shuttering with 2 or 4 sockets and 3 support spars each in the corners

U 71 BSK-NA height 25 mm, for nail fixing	979 530 01
U 71 BSK-2 height 25 mm, for exposed concrete, minimum visibility of the feet	979 530 02
U 71 BSK-K height 21 mm, for adhesive fixing	979 538 01
U 71 BSK height 21 mm, for magnet fixing, magnet hole has to be plastered later	979 539 01

BL blank strip

21 x 110 x 15 mm



Blank cleat for mounting the mounting box K0 EK and the mounting box K15 EK for opposing formwork, 2 pieces are required for each box

K0 K15 BL 2 blank cleats per box required	979 532 01
---	------------

K1 K2 BL blank cleats

21 x 90 x 15 mm



Blank cleat for fixing: 1. The special boxes K1 EK and K2 EK boxes for opposing formwork, 2. The cone funnel for transfer from risers, 2 pieces are required for each insert

K1 K2 BL	979 531 01
-----------------	------------

BS blank base

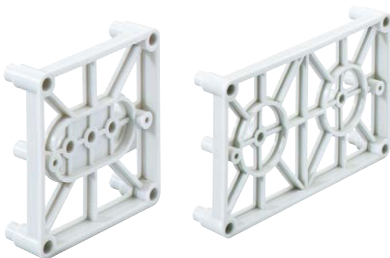

Blank base BS to support the BS boxes, for opposing formwork in conjunction with support spars

BS 1-BSK 86 x 86 x 25 mm, blank base	974 431 01
BS 2-BSK 146 x 86 x 25 mm	974 432 01

BSK blank base



Description

Order no.

Blank base to support the conduit elbows including conduit ferrules, for opposing formwork in conjunction with support spars

BSK 1 for conduit ferrules 970 518 01	970 500 01
BSK 2 for conduit ferrules 970 523 01 / 970 530 01	970 505 01

STH-STU support buffer



Support buffer as an attachment for support spars when using magnetic clamps or adhesive in vertical formwork (instead of the blank base)

STH-STU	979 535 01
----------------	------------

STH support spars

Ø 6 mm

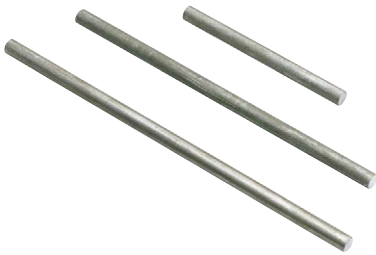

Support spars for various wall thicknesses in opposing formwork, always used in conjunction with blank base or back mounted box, spar length = wall thickness minus 1 cm, 2 support spars per socket, 4 support spars for extreme loads

	Wall thickness Spar length		
STH 70	8 cm	7 cm	979 570 01
STH 90	10 cm	9 cm	979 590 01
STH 100	11 cm	10 cm	979 600 01
STH 110	12 cm	11 cm	979 610 01
STH 130	14 cm	13 cm	979 630 01
STH 140	15 cm	14 cm	979 640 01
STH 150	16 cm	15 cm	979 650 01
STH 170	18 cm	17 cm	979 670 01
STH 190	20 cm	19 cm	979 690 01
STH 230	24 cm	23 cm	979 730 01
STH 240	25 cm	24 cm	979 740 01
STH 290	30 cm	29 cm	979 790 01

Fixings for wood / plastic formwork



Fixings for wood / plastic formwork, for site cast concrete or poured concrete construction on wooden formwork, use 2 nails for extreme loading

NA-AL aluminium nail, 40 mm, long-ridged	979 242 01
NA-AL/gl aluminium nail, 40 mm, smooth	979 243 01

Fixings for plastic/steel formwork

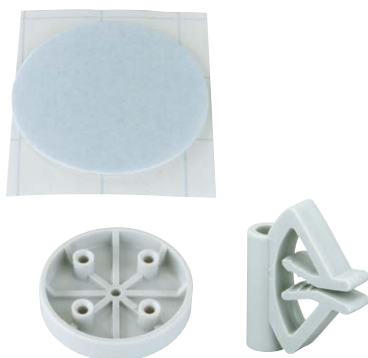

Description	Order no.
Fixings for plastic/steel formwork	
KR adhesive black, as a non-damaging fixing, when using blank and flange, (usable several times), with vertical formwork, also use support spars	979 248 01
HFL support flange 50 mm Ø, plastic	979 250 01
HC support clip for mesh thickness as an auxiliary fixing for the boxes onto (2 to 3 clips per box), only usable with support spars	979 245 01

Fixings for steel formwork



Description	Order no.
Fixings for steel formwork	
NAS-AL Spreader nail, aluminium 40 mm, with plastic plug for fixing the boxes on the steel formwork (drilled hole 5.5 mm), has proven excellent for tunnel formwork	979 240 01
ANSW weld on screw M6 x 10 mm, inexpensive, secure fixing of the box, onto steel formwork without drilling	979 260 01
HM magnetic clamps, 50 mm Ø, normal, pull-off strength 120 +/- 20 N	979 280 01
HM-UNI magnetic clamps, 50 mm Ø, extra strong, pull-off strength 300 +/- 20 N=30 kp	979 299 01
MA magnetic lifter for dismounting the magnetic clamps HM and HM-UNI, in two parts	979 300 01

Fixings for conduits and cables

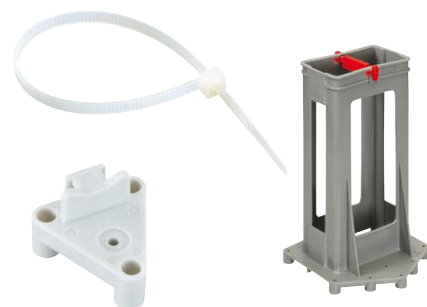

Description	Order no.
Fixings for conduits and cables	
KBI 1 clip 4.6 x 180 mm	979 136 01
ABH 1 spacer, 40 x 40 x 33 mm	979 135 01
ROS conduit support, grey, height 21 cm	979 230 01

RVB conduit connector



Description	Order no.
Conduit coupling (without conduit) with strain relief, grey, for flexible metric electrical installation conduits	
RVB 20 for long-ridged pipes M20	970 220 01
RVB 25 for long-ridged pipes M25	970 225 01
RVB 32 for long-ridged pipes M32	970 232 01
RVB 40 for long-ridged pipes M40	970 240 01

IBT LZA hand hole punch



Description

Order no.

Hand hole punch, punching tool for making precision fit entries in concrete boxes, perforation always 1 - 3 mm smaller than the conduit / conductor diameter

IBT LZA-OE	without punch set	978 100 01
IBT LZA-18	with 18 mm punch set for pipe M20	978 118 01
IBT LZA-23	with 23 mm punch set for pipe M25	978 123 01

WED expansion mandrel



Expansion mandrel, assembly tool when inserting conduit

WED	expansion range 9 - 25 mm Ø	979 155 01
-----	-----------------------------	------------

Punch sets



Punch sets as replacements or where expansion is required for IBT LZA hand hole punch

	hole diameter	for cable / conduit type (outside Ø)	
IBT STE-LZA/10	10 mm	NY 3 x 1.5 (11mm)	978 910 01
IBT STE-LZA/14	14 mm	M16 (16 mm)	978 914 01
IBT STE-LZA/18	18 mm	M20 (20 mm)	978 918 01
IBT STE-LZA/23	23 mm	M25 (25 mm)	978 923 01

LST hole punch



Hole punch for large scale operation in component factories, with fixing devices

LST	with 18 mm and 23 mm punch sets, as well as expansion mandrel	979 162 01
-----	---	------------

Punch sets



Punch sets for LST hole punch

	hole diameter	for cable / conduit type (outside Ø)	
IBT STE-LST/14	14 mm	M16 (16 mm)	978 814 01
IBT STE-LST/18	18 mm	M20 (20 mm)	978 818 01
IBT STE-LST/23	23 mm	M25 (25 mm)	978 823 01
IBT STE-LST/30	30 mm	M32 (32 mm)	978 830 01
IBT STE-LST/39	39 mm	M40 (40 mm)	978 839 01

BS MBR assembly bridge



Description

Order no.

Assembly bridge for the installation of British standard equipment in boxes BS 1 and BS 2, can be clicked into place and moved sideways

BS MBR 2 pcs. required per box	974 120 01
--	------------

BS ES installation screws



Installation screws for fixing BS equipment

BS ES-30	3.5 x 30 mm	974 130 01
BS ES-40	3.5 x 40 mm	974 135 01
BS ES-50	3.5 x 50 mm	974 150 01

HW LFR hole cutter



Hole cutter, 120 mm Ø, suitable for wood and gypsum concrete plates

HW LFR-120 HW hole cutter HW LFR-120, will fit any commercial drill chuck, diameter 120 mm Ø, cutting depth 40 mm	925 121 01
---	------------

Hole cutter

79 mm



Hole cutter

LFR through opening: M16-32, drill hole: 16.5-32.5 mm	195 995 01
---	------------

ES installation screws



Additional device screws for mounting built-in devices in cavity wall outlet sockets

ES-10	3.1 x 10 mm	979 105 01
ES-18	3.1 x 18 mm	979 106 01
ES-25	3.1 x 25 mm	979 107 01

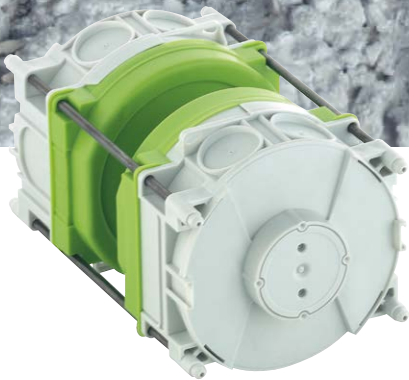

- ▲ Use as a back mounted box from wall thickness of 240 mm
- ▶ Integrated M25/M32 conduit stopper prevents the conduits from being pushed right through

- ▶ Simple assembly in site-cast concrete ceilings and walls as well as in pre-cast concrete
- ▶ IBTronic makes it possible to conveniently and elegantly integrate halogen and LED lights, loudspeakers and high-quality electronic components into concrete ceilings.
- ▶ IBTronic-TT enables simple installation of electronic safety transformers.

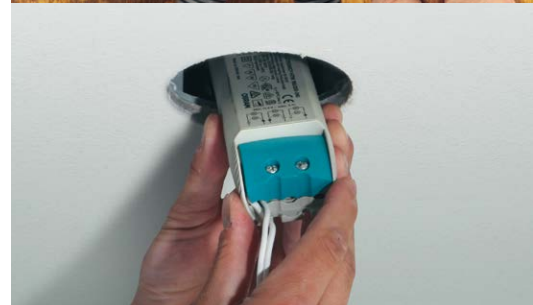

Concrete Installation IBTronic

IBTronic

150 x 150 x 106 mm



Entries: 4 x up to Ø 34 mm,
Integrated conduit stopper for M25 conduits,
M32

Description

Order no.

Universal mounting enclosure for site cast concrete or prefabricated concrete structure, for the installation of NV/HV/LED luminaires. Suitable for adhesive fixing and opposing formwork, for installation in ceilings from 140 mm, wall installation with IBT support spars, recommended accessories for mounting in site cast concrete applications: Nailing tool NAH IBTronic H120 order no. 979 218 01, use 4 support spars STH each for support spar technology, for the installation of VDE-approved lights per DIN EN 60598 (VDE 0711), as well as with F identification or MM identification, Max, installation height LV lights: 75 mm, HV lights: 80 mm, lamp rating max. 50 W

IP30



90°C



IBTronic H120-S1

outlet aperture: 1-way receptacle

976 001 01

IBTronic H120-S2

outlet aperture: 2-way receptacle

976 002 01

IBTronic H120-68

outlet aperture: Ø 68 mm

976 005 01

IBTronic H120-0

selectable outlet aperture: Ø 108/120 mm

976 003 01

IBTronic H120-P

selectable outlet aperture:
Fermacell® plasterboard,
variable up to Ø 100 mm

976 004 01

IBTronic

150 x 150 x 151 mm



Entries: 8 x up to Ø 34 mm,
Integrated conduit stopper for M25 conduits,
M32

Universal mounting enclosure for site cast concrete or prefabricated concrete structure, for the installation of NV/HV/LED luminaires. Suitable for adhesive fixing and opposing formwork, for installation in ceilings from 180 mm, wall installation with IBT support spars, recommended accessories for mounting in site cast concrete applications: Nailing tool NAH IBTronic H120 order no. 979 218 01, use 4 support spars STH each for support spar technology, For the installation of VDE-approved lights per DIN EN 60598 (VDE 0711), as well as with F identification or MM identification, Max, installation height LV lights: 120 mm, HV lights: 125 mm, lamp rating max. 50 W

IP30



90°C



IBTronic H120-S1-S2

selectable outlet aperture: 1-way or 2-way receptacle

976 101 01

IBTronic H120-S1-0

selectable outlet aperture: 1-way receptacle or Ø 108 / 120 mm

976 103 01

IBTronic H120-68-0

selectable outlet aperture: Ø 68 mm or Ø 108 / 120 mm

976 105 01

IBTronic H120-P-O

selectable outlet aperture:
Fermacell® plasterboard,
variable up to max. Ø 100 mm
or Ø 108 / 120 mm

976 104 01

Concrete Installation

IBTronic TT

306 x 150 x 106 mm



Entries: 6 x up to Ø 34 mm,
Integrated conduit stopper for M25 conduits,
M32

Description

Order no.

Universal mounting enclosure with separate connection space (e.g. for the installation of a safety transformer up to max. 150 VA) for site cast or prefabricated concrete structures, for the installation of NV/HV/LED-luminaires and loudspeakers and high-quality electronic components, suitable for adhesive fixing and opposing shuttering, for installation in ceilings from 140 mm, wall installation with IBT support spars, recommended accessories for mounting in site cast concrete applications:

Nailing tool NAH IBTronic H120 order no. 979 218 01, use 4 support spars STH each for support spar technology, for the installation of VDE-approved lights per DIN EN 60598 (VDE 0711), as well as with F identification or MM identification, Max, installation height LV lights: 75 mm, HV lights: 80 mm, lamp rating max. 50 W

IP30



90°C



IBTronic H120TT-S1

outlet aperture: 1-way receptacle

976 201 01

IBTronic H120TT-S2

outlet aperture: 2-way receptacle

976 202 01

IBTronic H120TT-68

outlet aperture: Ø 68 mm

976 205 01

IBTronic H120TT-0

outlet aperture: Ø 108 / 120 mm

976 203 01

IBTronic H120TT-P

selectable outlet aperture:

Fermacell® plasterboard, variable up to Ø 100 mm

976 204 01

IBTronic TT

306 x 150 x 151 mm



Entries: 6 x up to Ø 34 mm,
Integrated conduit stopper for M25 conduits,
M32

Universal mounting enclosure with separate connection space (e.g. for the installation of a safety transformer up to max. 150 VA) for site cast or prefabricated concrete structures, for the installation of NV/HV/LED-luminaires and loudspeakers and high-quality electronic components, suitable for adhesive fixing and opposing shuttering, for installation in ceilings from 180 mm, wall installation with IBT support spars, recommended accessories for mounting in site cast concrete applications:

Nailing tool NAH IBTronic H120 order no. 979 218 01, use 4 support spars STH each for support spar technology, for the installation of VDE-approved lights per DIN EN 60598 (VDE 0711), as well as with F identification or MM identification, Max, installation height LV lights: 120 mm, HV lights: 125 mm, lamp rating max. 50 W

IP30



90°C



IBTronic H120TT-S1-0

outlet aperture: 1-way receptacle

976 301 01

IBTronic H120TT-S2-0

outlet aperture: 2-way receptacle

976 302 01

IBTronic H120TT-68-0

outlet aperture: Ø 68 mm

976 305 01

IBTronic H120TT-O-0

outlet aperture: Ø 108 / 120 mm

976 303 01

IBTronic H120TT-P-0

selectable outlet aperture:

Fermacell® plasterboard variable up to max. Ø 100 mm or Ø 108 / 120 mm

976 304 01

Accessories



Description

Order no.

Recommended accessories:

KO K15 BL 2 blank cleats per box required	979 532 01
NS 35-90 standard rail (35 mm) for subsequent installation in IBTronic-TT H120TT-S2	979 800 01
FPD 120 Fermacell® plasterboard for retrospective installation in H120 P	979 801 01
HW LFR-120 HW hole cutter HW LFR-120, will fit any commercial drill chuck, diameter 120 mm Ø, cutting depth 40 mm	925 121 01

NAH



For fitting the IBTronic-P universal installation enclosure in site cast concrete applications. Four nailing tools per enclosure required, 1 set = 4 pcs.

NAH IBTronic H 120	979 218 01
---------------------------	------------

STH support spars

Ø 6 mm

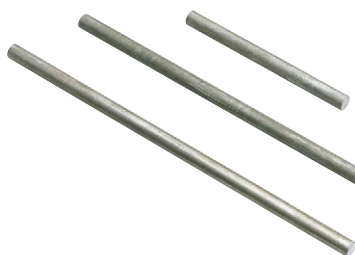

Support spars for various wall thicknesses in opposing formwork, always used in conjunction with blank base or back mounted box, spar length = wall thickness minus 1 cm, 2 support spars per socket, 4 support spars for extreme loads

	Wall thickness Spar length		
STH 70	8 cm	7 cm	979 570 01
STH 90	10 cm	9 cm	979 590 01
STH 100	11 cm	10 cm	979 600 01
STH 110	12 cm	11 cm	979 610 01
STH 130	14 cm	13 cm	979 630 01
STH 140	15 cm	14 cm	979 640 01
STH 150	16 cm	15 cm	979 650 01
STH 170	18 cm	17 cm	979 670 01
STH 190	20 cm	19 cm	979 690 01
STH 230	24 cm	23 cm	979 730 01
STH 240	25 cm	24 cm	979 740 01
STH 290	30 cm	29 cm	979 790 01

Concrete Installation



- For use with cast-in-place concrete and precast factory
- Low costs, faster installation
- Conduit adaptation without special tools
- Centreline marking on the housing
- Easy alignment of the housing on the formwork table
- Nail fastening outside the housing
- Conduit entry points above the prefabricated ceiling

- LED power, 15-47 watts
- 8 integrated conduit entry points for straight and corrugated conduits (4 x M20, 4 x M25)
- Integrated conduit stoppers and strain relief
- Simplified feed-in and through-wiring
- Knockout diaphragm entries

Available from June 2017!



Universal mounting enclosure IBT LED
for installing NV/HV/LED luminaires and loudspeakers

NEW!

www.spelsberg.com

IBT LED 1

152 x 200 x 135 mm



Description

Order no.

Universal mounting enclosure, for prefabricated construction, Halogen-free, for installing NV/HV/LED luminaires and loudspeakers., as well as messaging and call systems, suitable for adhesive fixing, for the installation of VDE-approved lights per DIN EN 60598 (VDE 0711), as well as with F identification or MM identification, maximum installation height for lamps, loudspeakers, messaging and call systems: 100 mm, Lamp output LED max. 15 W



IBT LED 1

outlet aperture: Fermacell® plasterboard, variable up to max. 100 x 100 mm, 8 combi-conduit entry points 4 x M20, 4 x M25 integrated conduit stopper and strain relief for conduits M20, M25

982 100 01

IBT LED 1 E

outlet aperture: Fermacell® plasterboard, variable up to max. 100 x 100 mm, 8 combi-conduit entry points 4 x M16, 4 x M19 integrated conduit stopper and strain relief for conduits M16, M19

982 100 02

IBT LED 2

202 x 250 x 135 mm



Universal mounting enclosure, for prefabricated construction, halogen-free, for installing NV/HV/LED luminaires and loudspeakers, as well as messaging and call systems, suitable for adhesive fixing, for the installation of VDE-approved lights per DIN EN 60598 (VDE 0711), as well as with F identification or MM identification, maximum installation height for lamps, loudspeakers, messaging and call systems: 100 mm, Lamp output LED max. 20 W



IBTLED 2

outlet aperture: Fermacell® plasterboard, Variable up to max. 150 x 150 mm, 8 combi-conduit entry points 4 x M20, 4 x M25 integrated conduit stopper and strain relief for conduits M20, M25

982 150 01

IBT LED 2 E

outlet aperture: Fermacell® plasterboard, Variable up to max. 150 x 150 mm, 8 combi-conduit entry points 4 x M16, 4 x M19 integrated conduit stopper and strain relief for conduits M16, M19

982 150 02

IBT LED 3

350 x 400 x 165 mm



Universal mounting enclosure, for prefabricated construction, Halogen-free, for installing NV/HV/LED luminaires and loudspeakers., as well as messaging and call systems, suitable for adhesive fixing, for the installation of VDE-approved lights per DIN EN 60598 (VDE 0711), as well as with F identification or MM identification, maximum installation height for lamps, loudspeakers, messaging and call systems: 130 mm, Lamp output LED max. 47 W



IBTLED 3

outlet aperture: Fermacell® plasterboard, variable up to max. 200 x 300 mm, 8 combi-conduit entry points 4 x M20, 4 x M25 integrated conduit stopper and strain relief for conduits M20, M25

982 200 01

IBT LED 3 E

outlet aperture: Fermacell® plasterboard, variable up to max. 200 x 300 mm, 8 combi-conduit entry points 4 x M16, 4 x M19 integrated conduit stopper and strain relief for conduits M16, M19

982 200 02



- Universal installation housing for mounting LV/HV/LED luminaires and loudspeakers in pre-cast concrete
- Fermacell®-plasterboard with tolerance compensation of Ø 185 mm
- Outlet aperture: variable to max. 150 mm
- Integrated transformer tunnel up to max. 150 VA
- Volume of 4.5 litres
- Simplified installation of transformers due to short cable runs
- Easy alignment due to marking of the centre of cover and enclosure
- 4 stainless steel clamps for secure hold, Fermacell® plasterboard can be used throughout
- No problem to find again after plastering thanks to plaster mark
- Stackable: - Minimal stock
- Protects Fermacell® plasterboard
- ▶ **Light installation**
- Drilling of ceiling aperture up to Ø 150 mm with the Spelsberg Profi hole cutter
- Transformer installation up to 150 VA
- For installation of VDE-approved luminaires according to DIN EN 60598 and with ∇ or $\nabla\nabla$ marking, luminaire power up to 50 W



Concrete Installation IBTronic XL H 185

IBTronic XL

255 x 280 x 130 mm



Description

Order no.

Universal mounting enclosure with additional connection space (e.g. for installing an electronic safety transformer) for pre-cast concrete structures, halogen-free, for installing NV/HV/LED luminaires and loudspeakers, suitable for adhesive and nail fixing, for the installation of VDE-approved lights per DIN EN 60598 (VDE 0711), as well as with F identification or MM identification, Max, installation height LV lights: 105 mm, HV lights: 110 mm, Lamp output max. 50W/LED 25W

IPX4



90°C



IBTronic XL H 185 F

outlet aperture: Fermacell® plasterboard, variable to max. Ø 150 mm,
8 combi-conduit entries 4 x M20, 4 x M25, integrated conduit stopper
for conduits M20, M25

976 604 01

IBTronic XL H 185 FE

outlet aperture: Fermacell® plasterboard, variable to max. Ø 150 mm,
8 combi-conduit entries 4 x 16 mm, 4 x 19 mm,
integrated conduit stopper and strain relief for 16 mm
and 19 mm pipes

976 604 02



- Universal installation housings for subsequent mounting in prefabricated ceilings
- For installation of LV/HV/LED luminaires
- The 2-part light adapter can easily compensate ceiling thickness of 45-70 mm without any problem. The ceiling aperture is 76 mm, the outer ring diameter of the luminaire must be at least 85 mm. The retaining springs are locked in the light adapter. The light unit is mounted so that the luminaire's cover ring is flush.

► Light installation

- Ø 82 mm core hole drilling
- Fix enclosure and install conduits
- Transformer installation up to 150 VA
- For installation of VDE-tested luminaires according to DIN EN 60598 and with ∇ or $\nabla\nabla$ marking, luminaire power up to 50 W Alu

► Flexible entry method

- 8 integrated conduit entries for smooth and corrugated conduits (4 x M20, 4 x M25)
- Integrated conduit stopper and strain relief
- Knock-out membrane entries, conduit entries above the prefabricated ceiling



Concrete Installation IBTronic XL Drillbox

IBTronic XL Drillbox

255 x 280 x 92 mm



Description

Order no.

Universal mounting enclosure with additional connection space (e.g. for installing an electronic safety transformer) for pre-cast concrete structures, halogen-free, for installing NV/HV/LED luminaires, suitable for subsequent installation in prefabricated ceilings 45-70 mm with Ø 82 mm core drilling, for the installation of VDE-approved lights per DIN EN 60598 (VDE 0711), as well as with F identification or MM identification, max. installation height LV lights: 105 mm, HV lights: 110 mm, lamp rating max. 50 W Alu



IBTronic XL Drillbox

outlet aperture: Ø 76 mm, ORD (Outer Ring Diameter), min. Ø 85 mm, 8 combi-conduit entries 4 x M20, 4 x M25, integrated conduit stopper for conduits M20, M25

976 801 01

IBTronic XL Drillbox E

outlet aperture: Ø 76 mm, ORD (Outer Ring Diameter), min. Ø 85 mm, 8 combi-conduit entries 4 x 16 mm, 4 x 19 mm, integrated conduit stopper and strain relief for 16 mm and 19 mm pipes

976 801 02

Accessories



Recommended accessories: IBTronic XL Drillbox, as replacement requirement

LMK 76

luminaire assembly kit LMK 76, for subsequent installation in IBTronic XL Drillbox 976 801 01

979 803 01

Accessories

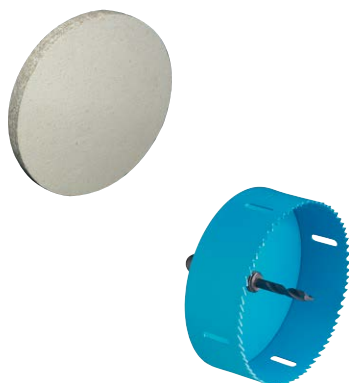

Recommended accessories:

FPD 120

Fermacell® plasterboard for retrospective installation in H120 P

979 801 01

HW LFR-120

HW hole cutter HW LFR-120, will fit any commercial drill chuck, diameter 120 mm Ø, cutting depth 40 mm

925 121 01



Flexible entry method

- 8 integrated conduit entries for smooth and corrugated conduits (4 x M20, 4 x M25)
- Integrated conduit stopper and strain relief
- Knock-out membrane entries, conduit entries above the prefabricated ceiling

- Universal installation housings for subsequent mounting in prefabricated ceilings
- For installation of LV/HV/LED luminaires and loudspeakers
- Ø 150 mm core hole drilling
- Fermacell® plasterboard with tolerance compensation of max. Ø 100 mm
- For installation of VDE-tested luminaires according to DIN EN 60598 and with ∇ or $\nabla\nabla$ marking, luminaire power up to 50 W Cool Beam



Concrete Installation IBTronic XL Drillbox 150

IBTronic XL Drillbox 150

255 x 280 x 92 mm



Description

Order no.

Universal mounting enclosure with additional connection space (e.g. for installing an electronic safety transformer) for pre-cast concrete structures, halogen-free, for installing NV/HV/LED luminaires and loudspeakers, suitable for subsequent installation in prefabricated ceilings 45-70 mm with Ø 150 mm core drilling.



IBTronic XL Drillbox 150

976 804 01

selectable outlet aperture:
Fermacell® plasterboard, variable up to Ø 100 mm,
8 combi-conduit entries 4 x M20, 4 x M25,
integrated conduit stopper for conduits M20, M25

IBTronic XL Drillbox 150 E

976 804 02

selectable outlet aperture:
Fermacell® plasterboard, variable up to Ø 100 mm,
8 combi-conduit entries 4 x 16 mm, 4 x 19 mm,
integrated conduit stopper for pipes 16 mm, 19 mm

Accessories

HW LFR-35

925 135 01

Diameter 35 mm Ø

HW LFR-68

925 168 01

Diameter 68 mm Ø

HW LFR-74

925 174 01

Diameter 74 mm Ø

Accessories



Hole cutter with spring for ejection of PCB, drilling depth up to 30 mm

	Diameter	
HW LFR-35	35	925 135 01
HW LFR-68	68	925 168 01
HW LFR-74	74	925 174 01
HW LFR-120	120	925 121 01

Concrete Installation



Cavity wall installation system

- Automatic cable restraint for conduits up to 20 mm Ø or cables NYM up to 5x2.5²
- Fast, easy installation thanks to favourable positioning of claws
- No special tools needed
- Pattress boxes with integrated combi-bridge for insulated wiring, no extra parts needed
- Combination of different heights possible
- Flush installation standard, no countersink necessary



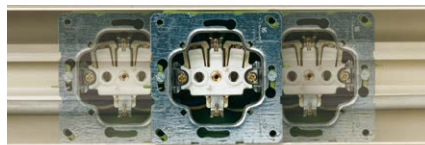

Trunking boxes

- Patented entries with strain relief
- Convenient insertion of the connecting cables from above
- For cables up to 5 x 2.5² and data lines
- Universal 1-way or 2-way boxes in various heights
- For switches, sockets (screw spacing 60 mm), CEE 16 A (screw spacing 67 mm)



Fast installation

- Snap box into place
- Connect device outside the box
- Insert the device and connecting cable from above and position the box
- Tighten screws - done!

	Protection rating	Types	Page
	IP30	Cavity wall sockets and boxes	282-284
		Accessories for cavity wall boxes	284-286
		Floor-mounted trunking boxes	288-289
		Front-mounted trunking boxes	290-291
		Accessories trunking boxes	291

HW 040 - Outlet socket

40 mm

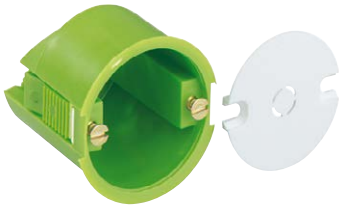

Description

Order no.

Cavity wall outlet socket, flame resistant, for lighting outlets acc. to VDE 0100, for plate thicknesses from 1 to 30 mm, screwing distance 27 mm, including white sealing cap

IP30

HW 040
Drilled hole Ø 35 mm, 40 mm deep

924 040 01

HW 035 - Flat box

35 mm



Cavity wall flat box, flame resistant, special box with small installation depth (35 mm), for thin walls with plate thicknesses from 1 to 20 mm, with moulded patented combi jumpers, device screw spacing 60 mm

IP30



HW 035
Drilled hole Ø 68 mm, 35 mm deep

920 035 01

HW 035 H

35 mm



Cavity wall flat box, flame resistant, special box with small installation depth (35 mm), for thin walls with plate thicknesses from 1 to 20 mm, with moulded patented combi jumpers, device screw spacing 60 mm

IP30



HW 035 H
Drilled hole Ø 68 mm, 35 mm deep

920 235 01

HW 050 - Receptacle

50 mm



Cavity wall receptacle, flame resistant, universal socket for plate thicknesses from 1 to 40 mm with moulded patented combi jumpers and punching tool, device screw spacing 60 mm

IP30



HW 050
drilled hole Ø 68 mm, 50 mm deep

920 050 01

HW 050 WD
with closed membrane entries, drilled hole Ø 68 mm, 50 mm deep

920 350 01

HW 050 H
50 mm



Description

Order no.

Cavity wall receptacle, flame resistant, universal socket for plate thicknesses from 1 to 40 mm with moulded patented combi jumpers and punching tool, device screw spacing 60 mm



HW 050 H
drilled hole Ø 68 mm, 50 mm deep

920 250 01

HW 065 - branch socket box
65 mm



Cavity wall channel junction box, flame resistant, with enlarged connection space, universal socket for plate thicknesses from 1 to 40 mm, with moulded, patented combi jumpers and punching tool, device screw spacing 60 mm



HW 065
drilled hole Ø 68 mm, 65 mm deep

920 065 01

HW 065 WD
with closed membrane entries, drilled hole Ø 68 mm, 65 mm deep

920 365 01

HW 065 H
65 mm



Cavity wall channel junction box, flame resistant, with enlarged connection space, universal socket for plate thicknesses from 1 to 40 mm, with moulded, patented combi jumpers and punching tool, device screw spacing 60 mm



HW 065 H
drilled hole Ø 68 mm, 65 mm deep

920 265 01

HW - Ceiling socket
50 mm



Cavity wall lighting connection socket, flame resistant, for plate thicknesses from 0.5 to 33 mm, with M5 brass bush to take a ceiling hook from the accessory range, acc. to DIN EN 60670-21, but max. loading on hook 20 N (2 kg)

IP30

HW DD
drilled hole Ø 68 mm, 50 mm deep

927 050 01

Cavity wall
trunking boxes

HW 070 - channel junction box

58 mm



Description

Order no.

Cavity wall connection socket, flame resistant, for plate thicknesses from 1 to 30 mm, device screw spacing 67 mm

IP30

HW 070
Drilled hole Ø 74 mm, 58 mm deep

925 070 01

HW 120 - Connection socket

65 mm



Cavity wall connection socket, flame resistant, for plate thicknesses from 7 to 35 mm, for terminals up to 4 mm², including white sealing cap

IP30

HW 120
Drilled hole Ø 120 mm, 65 mm deep

925 120 01

HW 050 - Double socket

50 mm



Cavity wall double socket, flame resistant, for plate thicknesses from 1 to 40 mm, with moulded patented combi jumpers and punching tool, device screw spacing 60 mm

IP30

HW 050/2
drilled hole Ø 2 x 68 mm, 50 mm deep, combination spacing 71 mm

923 050 01

HW 050/2 WD
with closed membrane entries, drilled hole Ø 2 x 68 mm, 50 mm deep, Combination spacing 71 mm

923 350 01

HWK - Terminal boxes

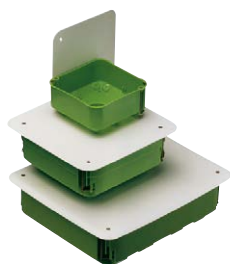

Cavity wall terminal boxes, flame resistant, for plate thicknesses from 7 to 35 mm, including white sealing cap

IP30



HWK 1
107 x 107 x 53 mm, with drilling template for 35 mm drilled holes

928 001 01

HWK 2
165 x 165 x 72 mm, with drilling template for 68 mm drilled holes

928 002 01

HWK 3
235 x 205 x 72 mm, with drilling template for 68 mm drilled holes

928 003 01

HW - Sealing cap

Ø 90 mm



Description

Order no.

Sealing cap for junction boxes, polystyrene, flame resistant, white

HW VD-60

for type HW 035 / HW 050 / HW 065, screw spacing 60 mm

925 101 01

HW VD-67

for type HW 070, screw spacing 67 mm

925 100 01

Cover with ceiling hook

Ø 90 mm



Sealing cap for cavity wall sockets, polystyrene, flame resistant, white, with isolated metal ceiling hooks M5 x 55 mm and fixing screws

HW 050 DD-VD

for ceiling socket HW DD

927 100 01

DH ceiling hook



Metal ceiling hook, insulated with M5 thread for ceiling sockets

Shaft length

DH 75-M5	75	979 117 01
DH 100-M5	100	979 119 01
DH 115-M5	115	979 121 01
DH 135-M5	135	979 123 01

HW device screws



Additional device screws for mounting built-in devices in cavity wall outlet sockets

ES-10	3.1 x 10 mm	979 105 01
ES-18	3.1 x 18 mm	979 106 01
ES-25	3.1 x 25 mm	979 107 01

HW hole cutter



Hole cutter with spring for ejection of PCB, drilling depth up to 30 mm

	Diameter	
HW LFR-35	35	925 135 01
HW LFR-68	68	925 168 01
HW LFR-74	74	925 174 01
HW LFR-120	120	925 121 01

Spare parts for hole cutter



Description

Order no.

Saw blade for hole cutter type 925 onwards

	Diameter	
HW LFR-35/SBL	35	929 935 01
HW LFR-68/SBL	68	929 968 01
HW LFR-74/SBL	74	929 969 01

Profi suitcase hole cutter



Hole cutter set comprising: 1 x profi cutter 35 mm, 1 x profi cutter 68 mm, 1 x profi cutter 74 mm, 1 x drive arbour, 1 x ejector spring, 1 x plastic case

HW LFRP-Sort 925 199 01

HW Profi hole cutter



Closed HSS bi-metallic cutter for long-term use with spring for ejection of PCB, drilling depth up to 40 mm

	Diameter	
HW LFRP-35	35	926 935 01
HW LFRP-68	68	926 968 01
HW LFRP-74	74	926 974 01

RVB conduit connector



Conduit coupling (without conduit) with strain relief, grey, for flexible metric electrical installation conduits

RVB 20 for long-ridged pipes M20	970 220 01
RVB 25 for long-ridged pipes M25	970 225 01
RVB 32 for long-ridged pipes M32	970 232 01
RVB 40 for long-ridged pipes M40	970 240 01

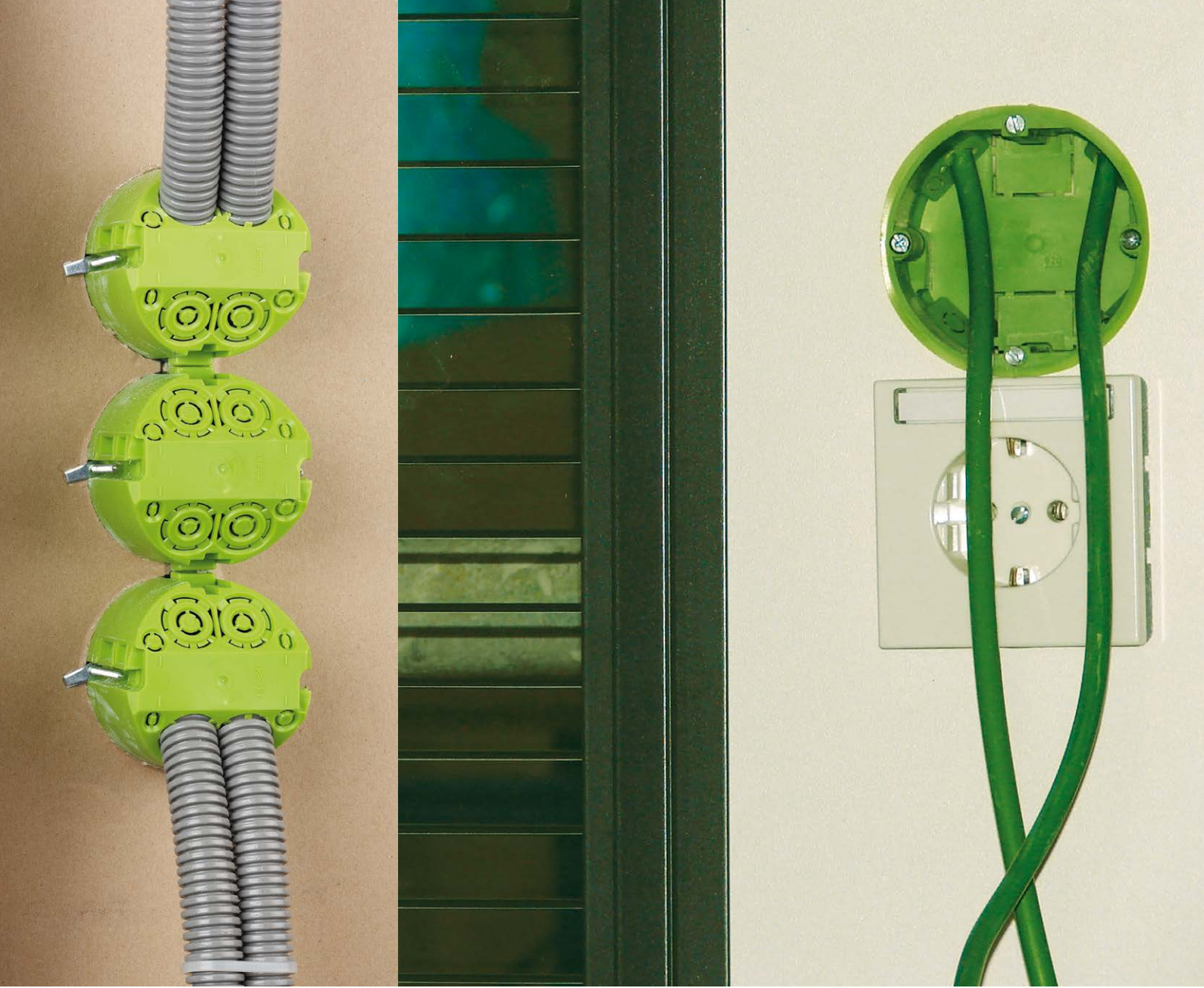

Cavity wall
trunking boxes

Floor-mounted trunking boxes

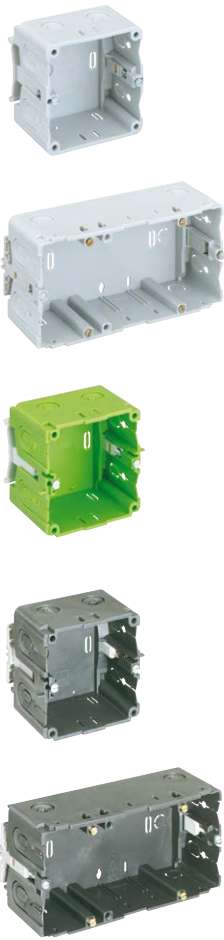

		Tehalit	Gewiss	Rehau	
Trunking boxes	Trunking	BR wall trunking PVC/ Alu	BR wall trunking PVC/Alu/Steel FB device installation trunking	Wall trunking PVC/Alu/ Steel (signo BK, BS, BA) FBK window sill trunking	
		from BR 70130	All sizes	All sizes	
Height 47 mm	1-way		370 047 01 Colour: grey		
	2-way		382 047 01 Colour: grey		
Height 50 mm	1-way				
	2-way				
Height 52 mm	1-way		370 052 01 Colour: green		
	2-way		382 052 01 Colour: green		
Height 55 mm	1-way	391 055 01 Colour: black			
	1-way				
	1-way			370 055 01 Colour: grey	
	2-way	392 055 01 Colour: black			
	2-way				
	2-way			382 055 01 Colour: grey	

Floor-mounted junction box with cover



		Gewiss	Rehau	
Trunking boxes	Trunking	BR wall trunking PVC/Alu/Steel FB device installation trunking	Wall trunking PVC/Alu/ Steel (signo BK, BS, BA) FBK window sill trunking	
		All sizes	All sizes	
Height 42 mm	1-way		370 042 01 Colour: green	370 042 01 Colour: green
	1-way			



Trunking boxes for other manufacturers available on request

	Kleinhuis		Ackermann
	HKL installation trunking (from HKL60110) GL device installation trunking	BS wall trunking PVC, insertion width 80/112 mm	Wall installation trunking WIK2, insertion width 110 mm steel
	GL (all sizes)	All sizes	from WIK2 65/133
	370 450 01 (*1) Colour: white	370 450 01 Colour: white	
	382 450 01 (*1) Colour: white	382 450 01 Colour: white	
			391 055 01 Colour: black
		370 455 01 Colour: grey	
			392 055 01 Colour: black
		382 455 01 Colour: grey	

	Kleinhuis		Niedax
	HKL installation trunking (from HKL60110) GL device installation trunking	BS wall trunking PVC, insertion width 80/112 mm	Device installation trunking GK 100, insertion width 110 mm steel
	GL (all sizes)	All sizes	All sizes
			370 042 01 (*2) Colour: green
	370 442 01 Colour: green	370 442 01 Colour: green	

(*1) = from GL 80150 only in conjunction with Kleinhuis bridge GLB80

(*2) = GK with depth of 80 mm and adapter rail TS 35 top-hat profile

 = Device installation for integrated appliances with cover frame

 = Device installation for integrated appliances with central disc



Front-mounted trunking boxes



		Gewiss	Rehau	Niedax
Trunking boxes	Trunking	BR wall trunking Insertion width 80 mm BR-PVC BR-Alu BR Steel (profiled)	Wall trunking PVC/Alu/Steel (signo BK, BS, BA)	Device installation trunking GK 78, Insertion width 78 mm Steel/Alu
	Height 47 mm			
Height 47 mm	1-way	361 107 01 Colour: grey	361 107 01 Colour: grey	
	1-way			361 407 01 Colour: green
Height 44 mm	2-way	362 104 01 Colour: grey	362 104 01 Colour: grey	
	2-way			362 404 01 Colour: green

CEE Mounting kit



Description	Order No.	Packing Qty
Installation kit for CEE devices 16 A (straight design) with flange dimensions 75 x 75 mm, spacing of the fixing holes 60 mm, suitable for individual boxes		
KD EBZ-CEE Check dimensions beforehand owing to large number of CEE devices available on the market.		372 100 01

 = Device installation for integrated appliances with cover frame



Trunking boxes for other manufacturers available on request

Fixing clamps



Description	Order No.	Packing Qty
Fixing clamps as additional fixing points for devices, to be snapped into sidewalls of individual boxes (bottom profile)		
KD GN-SND with self-cutting screws		370 400 01

Strain relief



Strain relief for installation in channel socket wall for increasing mechanical security, e.g. for vertical conduit laying, universal, to be retrofitted		
KD ZEL		370 402 01

Cavity wall
trunking boxes

Twist plug



IP54

Description

Order no.

Twist plug M_ x 1.5 mm with closed sealing membrane, polyethylene

	Thread length/mm	Sealing area/mm	
WST M16	9	5 - 10	203 416 01
WST M20	12	8 - 13.5	203 420 01
WST M25	12	9 - 16	203 425 01
WST M32	14	11 - 22	203 432 01
WST M40	14	17 - 24	203 440 01
WST M50	18	22 - 35	203 450 01
WST M63	20	24 - 43	203 463 01

Twist plug



IP54

Twist plug M_ x 1.5 mm with closed sealing membrane, polyethylene

	Thread length/mm	Sealing area/mm	
WST M16/sw	9	5 - 10	203 016 01
WST M20/sw	12	8 - 13.5	203 020 01
WST M25/sw	12	9 - 16	203 025 01

Twist nipple



IP54

Twist nipple M_ x 1.5 mm with open sealing membrane, polyethylene

	Thread length/mm	Sealing area/mm	
WNI M16	9	5 - 10	213 416 01
WNI M20	12	8 - 13.5	213 420 01
WNI M25	12	9 - 16	213 425 01
WNI M32	14	13 - 23	213 432 01

Twist nipple



IP54

Twist nipple M_ x 1.5 mm with open sealing membrane, polyethylene

	Thread length/mm	Sealing area/mm	
WNI M16/sw	9	5 - 10	213 016 01
WNI M20/sw	12	8 - 13.5	213 020 01
WNI M25/sw	12	9 - 16	213 025 01

Sealing plugs



IP54

Blanking plug with closed sealing membrane, thermoplastic elastomer (TPE), no lock nuts required

	f. wall thicknesses/mm	Sealing area/mm	
VST M16	1,5 - 4,5	6 - 10	231 416 01
VST M20	1,5 - 4,5	8 - 13.5	231 420 01
VST M25	1,5 - 4,5	9 - 16	231 425 01
VST M32	1,5 - 4,5	13 - 23	231 432 01
VST M40	1,5 - 4,5	17 - 30	231 440 01

PA blanking plug



IP68

Description

Blanking plug M_ x 1.5 mm, polyamide

Order no.

	f. wall thicknesses/mm	Thread length/mm	
VSS PA M16	0,5 - 3,0	6	211 116 01
VSS PA M20	0,5 - 3,0	6	211 120 01
VSS PA M25	0,5 - 3,0	11	211 125 01
VSS PA M32	0,5 - 3,0	11	211 132 01

Attachment bushes



IP54

Attachment bushes with open sealing membrane, no lock nuts required

		Sealing area/mm	
AST M16		6 - 10	230 416 01
AST M20		8 - 13.5	230 420 01
AST M25		9 - 18.5	230 425 01
AST M32		13 - 23	230 432 01
AST M40		17 - 30	230 440 01

Double membrane seals



IP66

Double membrane seals made of elastic plastic with two sealing membranes, closed

	f. wall thicknesses/mm	Sealing area/mm	
DMS M16	1.5 - 4.5	5 - 9	260 416 01
DMS M20	1.5 - 4.5	7 - 12	260 420 01
DMS M25	1.5 - 4.5	9 - 16	260 425 01
DMS M32	1.5 - 4.5	14 - 21	260 432 01
DMS M40	1.5 - 4.5	19 - 28	260 440 01

Double membrane seals



IP66

Double membrane seals made of elastic plastic with two sealing membranes, closed

	f. wall thicknesses/mm	Sealing area/mm	
DMS M20/sw	1.5 - 4.5	7 - 12	260 020 01
DMS M25/sw	1.5 - 4.5	9 - 16	260 025 01
DMS M32/sw	1.5 - 4.5	14 - 21	260 032 01

Double membrane seals



IP66

Double membrane seals made of elastic plastic with two sealing membranes, max. four cable entries for control cables

	f. wall thicknesses/mm	Sealing area/mm	
DMS M32/4	1,5 - 4,5	4 x 3.5 - 6	260 433 01

Stepped nipple



IP55

Description

Order no.

Stepped nipple with closed sealing membrane, can be cut in several steps, thermoplastic elastomer

	f. wall thicknesses/mm	Sealing area/mm	
SNI M20	1,5 - 4,5	5 - 16	216 420 01
SNI M25	1,5 - 4,5	5 - 21	216 425 01
SNI M32	1,5 - 4,5	13 - 26,5	216 432 01
SNI M40	1,5 - 4,5	13 - 34,0	216 440 01

Ventilation seal



IP44

With ventilation seal to avoid condensation formation in enclosures, flow rate 100 l/min. at 0.1 bar overpressure, thermoplastic elastomer, grey, recommended for insertion on the left and right enclosure sides in different heights (see Technical Appendix - protection against condensate water)

	f. wall thicknesses/mm	Color	
BST M20	1,5 - 4,5	Grey	262 420 01
BST M20/sw	1,5 - 4,5	black	262 020 01

Ventilation element set



IP65

BEL Air ventilation element set, For preventing condensation build-up in housings, For vertical installation in housing walls and GFL combi flanges with corresponding knock-outs, At least two ventilation elements are required per housing

IK08

BEL Air M40 263 440 01
M40, Set = 2 pcs., Air exchange rate: 30 l / day / set

UL US

Pressure compensation device



IP68
IP66

Pressure compensation device with air-permeable and watertight special membrane foil to reduce condensation formation in enclosures, flow rate 0.8 l/min. at 0.1 bar overpressure, grey polyamide, without lock nut

DAE M12 262 412 01
M12 x 1.5 mm, Thread length 10 mm

Combi connector



IP54

Combi connector, for connecting enclosures, thermoplastic, for wall thickness 1.5 - 4.0 mm

	f. wall thicknesses/mm	
KST M32	1,5 - 4,0	193 032 01
KST M25-33	1,5 - 4,0	193 026 01
KST M25-17	1,5 - 4,0	193 025 01

Combi set



IP66

Description

Order no.

Combi set, for side connection of enclosures with metric entries, complete with lock nuts and intermediate wall seal inserts

	f. wall thicknesses/mm	Thread length/mm	
KS M20	2 x 3,0	12	192 020 01
KS M25	2 x 3,0	12	192 025 01
KS M25-gro	2,0 x 8,0	22	192 026 01
KS M32	2 x 3,5	14	192 032 01

Cable gland



IP68

Cable gland with strain relief, polyamide, M_ x 1.5 mm, with lock nut

	Thread length/mm	Sealing area/mm	
KVR M12-MGM	8	2 - 6.5	227 412 01
KVR M16-MGM	8	4 - 10.0	227 416 01
KVR M20-MGM	9	6 - 12.0	227 420 01
KVR M20-GDB/MGM	9	7 - 14.0	227 421 01
KVR M25-MGM	11	9 - 16	227 425 01
KVR M32-MGM	11	11 - 21.0	227 432 01
KVR M40-MGM	11	16 - 28.0	227 440 01
KVR M50-MGM	13	21 - 34.5	227 450 01
KVR M63-MGM	17	30 - 44.5	227 463 01

Cable gland



IP68

Cable gland with strain relief, polyamide, M_ x 1.5 mm, without lock nut

	Thread length/mm	Sealing area/mm	
KVR M12	8	2 - 6.5	247 412 01
KVR M16	8	4 - 10.0	247 416 01
KVR M20	9	6 - 12.0	247 420 01
KVR M20-GDB	9	7 - 14.0	247 421 01
KVR M25	11	9 - 16	247 425 01
KVR M32	11	11 - 21.0	247 432 01
KVR M40	11	16 - 28.0	247 440 01
KVR M50	13	21 - 34.5	247 450 01
KVR M63	17	30 - 44.5	247 463 01

Cable gland



IP68

Cable gland with strain relief, polyamide, M_ x 1.5 mm, black, with lock nut

	Thread length/mm	Sealing area/mm	
KVR M20-MGM/sw	9	6 - 12.0	227 020 01
KVR M20-GDB/MGM/sw	9	7 - 14.0	227 021 01
KVR M25-MGM/sw	11	9 - 16	227 025 01
KVR M32-MGM/sw	11	11 - 21.0	227 032 01
KVR M40-MGM/sw	11	16 - 28.0	227 040 01
KVR M50-MGM/sw	13	21 - 34.5	227 050 01

Conduit connectors



IP54



Description

Order no.

Conduit connector to take smooth conduits with lock nut, polystyrene

	for conduits		
RST M16	Ø 16		288 416 01
RST M20	Ø 20		288 420 01
RST M20-16	Ø 16		288 421 01
RST M20-19	Ø 19		288 422 01
RST M25	Ø 25		288 425 01
RST M32	Ø 32		288 432 01

Lock nut



Lock nut for metric twist nipple and cable glands, polyamide

	Thread	
GMU PA M12	M12 x 1.5	208 412 01
GMU PA M16	M16 x 1.5	208 416 01
GMU PA M20	M20 x 1.5	208 420 01
GMU PA M25	M25 x 1.5	208 425 01
GMU PA M32	M32 x 1.5	208 432 01
GMU PA M40	M40 x 1.5	208 440 01
GMU PA M50	M50 x 1.5	208 450 01
GMU PA M63	M63 x 1.5	208 463 01

Sealing washers



Sealing washers M_ x 1.50 mm for twist nipple and cable gland with metric thread, polyethylene

	Internal Ø	External Ø	
ADR M12	12.0 mm	16.0 mm	249 012 01
ADR M16	16.0 mm	20.0 mm	249 016 01
ADR M20	20.4 mm	25.0 mm	249 020 01
ADR M25	25.0 mm	30.0 mm	249 025 01
ADR M32	32.0 mm	38.0 mm	249 032 01
ADR M40	40.0 mm	45.0 mm	249 040 01
ADR M50	50.0 mm	56.0 mm	249 050 01
ADR M63	63.0 mm	70.0 mm	249 063 01

Adapter ring without thread



Adapter ring for attaching metric accessories in housing with PG entries, for example for upgrades, polyethylene

	Thread	Housing Insert	
ARI Pg 9	M12	Pg 9	251 112 01
ARI Pg 11	M16	Pg 11	251 216 01
ARI Pg 16	M20	Pg 16	251 420 01
ARI Pg 21	M25	Pg 21	251 525 01
ARI Pg 29	M32	Pg 29	251 632 01

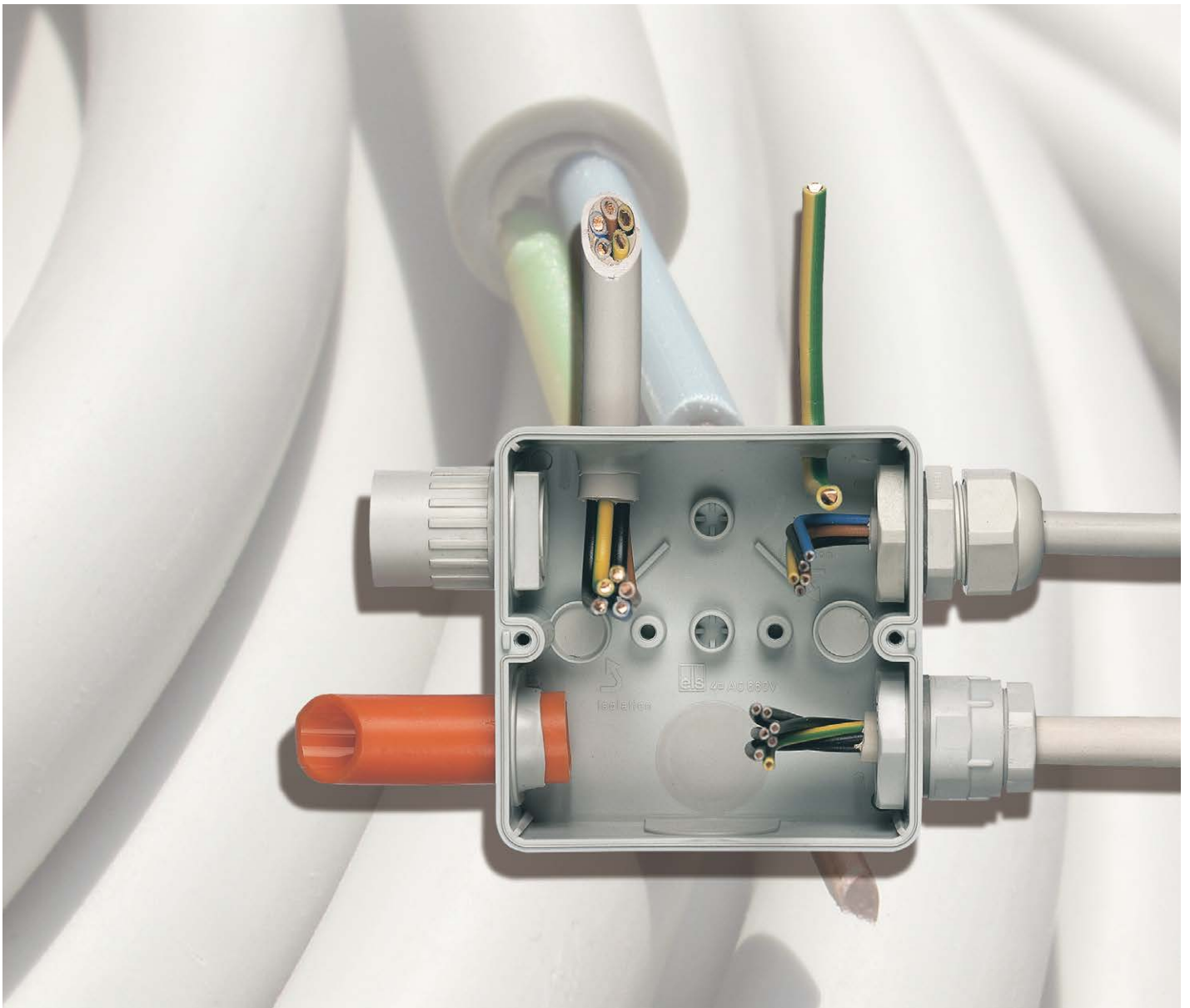









































Always the right accessories ...



	Page
Explanation of pictograms	300-301
Definition of terms	303
Overview of the ambient temperatures and mechanical properties of els products	304
Overview of the properties of materials used in the els installation systems	305
Power loss details	306
Power loss details for AK-/AK-F -installation small distributors	306
Power loss details for AK-/AKi- Compact-installation small distributors	307
Power loss details for for individually mounted AK-/AKi-/ZKi-/GTi-empty enclosures	307
Power loss details for AK-/AKi-/GTi-empty enclosures mounted in groups	308
Power loss details for STV-empty enclosures	309
Power loss details for for individually mounted TK-empty enclosures	310-311
Power loss details for for individually mounted TK AL und TG-empty enclosures.....	312
Power loss of the els product installations.....	313
Assembly and installation notes	314
1. Mounting of junction boxes on wood and other combustible materials	314
2. Halogen-free installation materials	314
3. Outdoor installation – Damp and wet areas and rooms	315
4. Installing cables in concrete	318
5. Protection classes of electrical equipment	318
6. Protection types according to DIN EN 60529 (VDE 0470-1)	319
The first digit of the IP Code	319
Comparison table between IP code and NEMA types	319
The second digit of the IP code.....	320
Overview of cable entries and the associated sealing ranges.....	322
7. Protection against mechanical stress, IK code.....	322
8. Installation dimensions of the els installation products	323
9. PE/N disconnect terminals.....	323

	Page
Overview of the installation areas and the recommended els installation systems	324
Protection against direct contact (basic protection) under standard conditions according to DIN VDE 0100-410	325
Rooms with baths or showers according to DIN VDE 0100-701	326
Swimming pool basins and other basins according to DIN VDE 0100-702	327
Agricultural and horticultural estates according to DIN VDE 0100-705	327
Damp and wet environments and rooms and outdoor installations according to DIN VDE 0100-737	328
Electrical equipment at camping and caravan sites and similar areas according to DIN VDE 0100-708	329
Electrical installations for caravans and motor caravans according to DIN VDE 0100-721	329
Electrical installations for pleasure craft or houseboats, marinas and similar areas according to DIN VDE 0100-709	329
Temporary electrical equipment, for example at fairgrounds, amusement parks and circuses according to DIN VDE 0100-740	330
Electrical equipment in furniture and similar fittings according to DIN VDE 0100-724	331
Photovoltaic systems according to DIN VDE 0100-712	331
Tests and test methods according to IEC/EN standard	332
Proof of mechanical structure	333
Proof of the strength of materials and parts	334
Proof of electrical stability	335
Tests and test methods according to UL – Underwriters Laboratories	338
Network types	342
Conformity to specifications and standards	344
Notes for the handover of a system	345

		Class of protection (IP code) acc.to DIN EN 60529 (VDE 0470-1)
		Maximum number of distribution units
		Electrical functional integrity acc.to DIN 4102-12 "E" stands for functional integrity, "30-90" stands for the duration in minutes.
		Insulation integrity according to VDE 0472-814, IEC 60331 "FE" stands for the impact of flames or fire, "180" stands for the time in minutes
		Operating duration acc. to DIN EN 12101-3 120 minutes function at 400 °C
		Tested acc. to DIN 4102-2. Functional integrity F90 (according to E90) for protecting the electrical installations as per MLAR 2005. Can be individually equipped with type-tested operating materials.
		Tested acc. to DIN 4102-2. Fire load insulation F90 (according to E90) for protecting the exit and escape routes as per MLAR 2005.
		Fire-resistance class S 90 acc. to DIN 4102-9
		Certificate of conformity. Conformity of the construction product with the technical regulations is documented by the "Ü label"
		The German general building supervisory approval (AbZ) attests the usability of an object under approval in the sense of the building regulations. It is granted by the German Institute of Structural Engineering (DIBt), Berlin, for construction products and types of construction, where no harmonised European standards have yet been applied for them and which are also not regulated by German standards or regulations.
		German general building inspection test certificate (AbP) is granted for unregulated construction products and construction methods whose use is not intended to meet the full safety criteria for structures. The granting is carried out by recognised testing bodies.
		Nominal cross section The greatest permissible wire cross-section that can be connected acc. to DIN EN 60998 (VDE 0613) and DIN EN 60999 (VDE 0609)
		Level of protection (IK code) to mechanical impact acc. to DIN EN 50102 (VDE 0470-100)
		Protection class II operating materials with protective insulation to DIN VDE 0100-410
		Maximum voltage DC (DC voltage) as per product standard (system voltage in the PV sector)

		Nominal AC voltage (AC voltage). Highest permissible voltage on the junction as per product norm
		Rated current (maximum current in continuous operation) as per product norm
		Products for installation in cavity walls or furnishings acc. to DIN VDE 0606-1
		Products for use in concrete construction acc. to DIN VDE 0606-1
		Suitable for the installation of lamps in which dichroic reflector lamps (cool beam reflectors) can be used. Reduces the thermal load in the light bundle.
		Suitable for LED lights
		Suitable for use in concrete. Resistant to momentary temperatures of up to +90 °C during the setting process.
		960°C glowing wire testing
		The VDE symbol stands for the tested safety of the product with regard to electrical, mechanical, thermal and other hazards.
		c UL us (Underwriters Laboratories) approved (US and Canadian approval)
		UL EU New European test certificate for certification recognised across Europe.
		DLG FokusTest for special innovations of machines and technical products - predominantly in agricultural and forestry applications.
		AK Air Ventilation elements to prevent accumulation of condensate while maintaining protection class IP65.
		Vattenfall approval
		Halogen-free enclosure , without halogens such as fluorine, chlorine and bromine.
		Industrial quality



Industrial quality

Industrial quality stands for products designed for special requirements and use in demanding environments. Such categories include installations in wet rooms and outdoors as well as on combustible surfaces or in locations that are subject to fire hazards. Enclosures used in such environments must all have one thing in common: **Resilience, safety, ruggedness and longevity.**

Products with this symbol indicate at a glance boxes and enclosures for applications with particularly stringent requirements with respect to material that has been tested as flame resistant and self-extinguishing in accordance with VDE 0471/EN60695/UL94 and consequently offers added security. The Abox-i*, Abox-i SL, AK*, AKi, GTi, TK-PC, TG-PC, WKE and ZKi series, made from high-quality technical plastics, satisfy the strictest material requirements.

* Abox-i 060 or higher

* AK 14 or higher

Common features of all products featuring the IQ symbol:

- Operating temperature from -35°C to 80°C
- Resistant to petrol, petroleum, fats, diesel fuel, turpentine and, to a limited extent, acids and alcohol
- Protection rating up to IP68
- UV- and weather-resistant
- Flame-resistant and self-extinguishing 960°C as per VDE 0471 / EN 60695 / UL94
- Impact-resistant and shatterproof under mechanical stress up to IK09
- Free of halogens, heavy metals, PVC and silicone

Definition of terms
as per DIN VDE 0660-600-1
(see DIN VDE 0100-200)

Rated voltage U_n

The manufacturer's specified maximum nominal AC voltage (effective value) or DC voltage for which the main circuits of the switchgear assembly are designed.

Rated operating voltage U_e

The manufacturer's specified voltage value which, combined with the rated current, determines the usage.

Rated insulation voltage U_i

Withstand voltage (effective value), which is specified by the manufacturer for a device or a part thereof and which specifies the defined (long-term) endurance of its associated insulation.

Rated surge voltage U_{imp}

The value of an impulse voltage specified by the manufacturer, which specifies the defined endurance of the insulation with respect to transient overvoltages.

Rated current I_n

The manufacturer's stated current value, which takes into account the ratings of the equipment and their location and use and which can be fulfilled without exceeding the specified temperature limits of the various parts of the switchgear assembly under specified conditions.

Short-circuit current I_c

Overcurrent that occurs in the case of a short circuit due to an error or an incorrect connection in an electrical circuit.

Prospective short-circuit current I_{cp}

Current that flows in a circuit due to a short circuit caused by a conductor of negligible impedance in the immediate vicinity of the terminals of the switchgear assembly.

Rated surge current resistance I_{pk}

The largest instantaneous value of the short-circuit current specified by the manufacturer, which will be sustained under the specified conditions.

Rated short-term current resistance I_{cw}

The effective value of the short-time current specified by the manufacturer, indicated as current and time, which can be fulfilled under specified conditions without damage.

Rated conditional short-circuit current I_{cc}

The value of the prospective short-circuit current specified by the manufacturer, which can be withstood by a circuit protected by a short-circuit protection device (SCPD1) during the total break time (duration of current flow) of the device under specified conditions.

Rated current I_n

The manufacturer's stated current value, which takes into account the ratings of the equipment and their location and use and which can be fulfilled without exceeding the specified temperature limits of the various parts of the switchgear assembly under specified conditions.

Rated load factor RDF²⁾

The manufacturer's specified percentage of the rated current, with which the outflow of a switchgear assembly can be loaded continuously and simultaneously taking into account the mutual thermal influences.

¹⁾ SCPD= Short Circuit Protection Device

²⁾ RDF= Rated Diversity Factor

Overview of the ambient temperatures and mechanical properties of els products

Table 1

	Empty enclosures			Enclosures with fittings			Maximum relative humidity at 40°C	Maximum relative humidity at 25°C (short-term)	Protection rating according to 60529 / VDE 0470-1 ¹	Shock-proof as per DIN EN 50102 / DE 0470 Part 100
	Ambient temperature Minimum value	Ambient temperature Maximum value	Ambient temperature Average value over 24 h	Ambient temperature Minimum value	Ambient temperature Maximum value	Ambient temperature Average value over 24 h				
Red range / HP	-25°C	40°C	35°C	-25°C	35°C	25°C	50%	95%	IP55	IK07
Abox Junction boxes	-25°C	40°C	35°C	-25°C	35°C	25°C	50%	95%	IP65	IK07
Abox-i Junction boxes	-35°C	80°C	60°C	-25°C	35°C	25°C	50%	95%	IP65	IK08
WK Junction boxes	-25°C	40°C	35°C	-25°C	35°C	25°C	50%	95%	IP54	IK05
WKE 2-5 Junction boxes	-25°C	40°C	35°C	-25°C	35°C	25°C	50%	95%	IP65	IK05
WKE 200-400 Junction boxes	-25°C	40°C	35°C	-25°C	35°C	25°C	50%	95%	IP66	IK08
WKE 54 Junction boxes	-25°C	40°C	35°C	-25°C	35°C	25°C	50%	95%	IP67	IK07
WKE AK Housing system	-25°C	40°C	35°C	-25°C	35°C	25°C	50%	95%	IP54	IK10
RK / RKA Terminal block housing	-25°C	40°C	35°C	-25°C	35°C	25°C	50%	95%	IP65	IK07
AL / ALR / TK AL Aluminium housings	-35°C	75°C	60°C	-25°C	40°C	35°C	50%	95%	IP66	IK09
IBT / IBTronic Concrete installation system	-25°C	40°C	35°C	-25°C	35°C	25°C	50%	n.a.	IP30	n.a.
AK Kompakt Distribution boards	-25°C	40°C	35°C	-25°C	40°C	35°C	50%	95%	IP65	IK07
AKi Kompakt Distribution boards	-35°C	80°C	60°C	-25°C	40°C	35°C	50%	95%	IP65	IK08
AK Air Distribution boards	-35°C	80°C	60°C	-25°C	40°C	35°C	50%	95%	IP65	IK08
AKL Empty enclosures	-25°C	40°C	35°C	-25°C	40°C	35°C	50%	95%	IP65	IK07
AKi Empty enclosures	-35°C	80°C	60°C	-25°C	40°C	35°C	50%	95%	IP65	IK08
SVi Automatic machine enclosures	-35°C	80°C	60°C	-25°C	40°C	35°C	50%	95%	IP65 ⁴⁾	IK07
STV Empty socket distribution boxes	-35°C	80°C	60°C	-25°C	40°C	35°C	50%	95%	IP44 ²⁾	IK08
TK-PS (Polystyrol) Empty enclosures	-25°C	40°C	35°C	-25°C	40°C	35°C	50%	95%	IP66	IK07
TK-PC (Polycarbonat) ³⁾ Empty enclosures	-35°C	80°C	60°C	-25°C	40°C	35°C	50%	95%	IP66	IK08
TG ABS empty enclosures	-25°C	40°C	35°C	-25°C	40°C	35°C	50%	95%	IP66/ IP67	IK07
TG-PC (Polycarbonat) ³⁾ Empty enclosures	-35°C	80°C	60°C	-25°C	40°C	35°C	50%	95%	IP66/ IP67	IK08
HW Cavity wall installation system	-25°C	40°C	35°C	-25°C	40°C	35°C	50%	n.a.	IP30	n.a.
KD Channel installation system	-25°C	40°C	35°C	-25°C	40°C	35°C	50%	n.a.	IP20	n.a.

Additional note:

The specified temperatures may be limited by the installed devices.

¹⁾ For use with suitable connectors or cable glands

²⁾ With closed socket covers

³⁾ V-2 material has passed the flame test of UL 746C (see note on page 329).

Overview of the properties of materials used in the els installation systems

The materials used by Spelsberg were subjected to a weathering test according to DIN 53 387 (replaced by DIN EN ISO 4892-2), a 1000 hour test at the „State Examination Office“ in Dortmund. The materials used in the IQ products demonstrate optimum results here. The material also passed a test for UV resistance according to UL 746 C, without any limitations.

Table 2

Material		Use in the products	Weak acids	Strong acids	Weak bases	Strong bases	Alcohol	Petrol	Benzene	Mineral oil	Diesel	Ammonia, liquid	Ammonia, gaseous (DLG Fokustest)	Vegetable fats	Animal fats	Halogen-free	Free of heavy metals, PVC and silicone	Flammability acc. to DIN EN 60695 (VDE 0471) / UL94
Polystyrene, shock-proof		AK compact system, Abox, RK / RKA, TK-PS	O	Ø	O	O	O	X	X	O	X	O	n.a.	O	X	yes	yes	650°C / HB
ABS (Acrylonitrile-Butadiene-Styrene)		TG-ABS	O	Ø	O	O	O	X	X	O	O	O	n.a.	Ø	Ø	yes	yes	650°C / HB
Polycarbonate, glass fibre-reinforced		Abox-i, STV/STG, AK, GTi system, AKi, TK-PC, ZKi, ZVi, SVi	O	X	X	X	O	Ø	X	O	Ø	X	O	O	Ø	yes	yes	960°C / V-2 (5VA*)
Polycarbonate		TG-PC, AK	O	X	X	X	O	Ø	X	O	Ø	X	O	O	Ø	yes	yes	960°C / V-2 (5VA*)
Polycarbonate, transparent		Hinged lid AK small-scale distributor and STV, lid AKL, AKi, GTi, TK-PC	O	X	X	X	Ø	Ø	X	O	Ø	X	O	O	O	yes	yes	850°C / V-2
Polyethylene		Attachment bushes, twist nipple, Red Range (bottom section)	O	O	O	O	O	Ø	X	O	X	O	n.a.	O	O	yes	yes	650°C / HB
Polypropylene		HW series, KD channelsockets, HP	O	O	O	O	O	Ø	Ø	O	X	O	n.a.	O	O	no	yes	960°C / V-2
Polypropylene copolymer		IBT / IBTronic Red Range (lid)	O	O	O	O	O	Ø	Ø	Ø	Ø	O	n.a.	O	O	yes	yes	650°C / HB
Polyurethane		All types with foamed lid seal	Ø	Ø	Ø	Ø	Ø	Ø	Ø	X	Ø	Ø	O	O	O	yes	yes	650°C / ---
Aluminium		AL, ALR, TK AL	O	Ø	O	O	O	O	O	O	O	O	n.a.	O	O	yes	yes	---
Duroplastic		WK junction boxes, WKE fireproof junction boxes, S-Box junction boxes	Ø	Ø	Ø	Ø	O	O	O	O	O	O	n.a.	O	O	yes	yes	960°C / V-0
Duroplastic		WK series integrated terminal block except for 4 mm ²	X	X	Ø	X	O	O	O	O	O	O	n.a.	O	O	yes	yes	960°C / V-0
Polyamide 6, glass fibre-reinforced		Screw fittings to IP 68, Cover screws	X	X	O	O	O	O	Ø	O	O	O	O	O	O	yes	yes	750°C / HB/V-2
Thermoplastic elastomer		Double-membrane glands, inlet membranes (Abox 025 / 040, 2K-12)	O	Ø	O	Ø	O	Ø	Ø	Ø	Ø	Ø	O	O	O	yes	yes	750°C / HB

O = resistant Ø = partially resistant X = not resistant

* Material (TK-PC, TG-PC) has passed the flame test of UL 94 / UL 746C (see note on page 329)

When selecting the installation location, the climatic conditions and the occurrence of chemical influences should generally be examined in addition to the protection rating. Details of material properties and chemical resistance of the materials used can be referenced in the tables, though these are simply guide values.

The AK distribution board can be used both as a GP (universal) housing and as a PD housing for pre-defined equipment installations per standard EN 60670-24.

Table 3

	Max. power output characteristics (P _{de}) for GP housings per EN 60670-24 [for each profile rail] ¹⁾	Achievable power loss in PD housings per EN 60670-24 [for each profile rail] ²⁾
Type		
AK 14 / AK-F 14	26W[26W]	35W[35W]
AK 28 / AK-F 28	35W[17,5W]	48W[24W]
AK 42 / AK-F 42	45W[15W]	62W[20W]
AK 56 / AK-F 56	56W[14W]	77W[19W]
AK 70	66W[13W]	90W[18W]
	Max. power output characteristics (P _{de}) for GP housings per EN 60670-24 [for each profile rail] ¹⁾	Achievable power loss in PD housings per EN 60670-24 [for each profile rail] ²⁾
Type		
AK 14 Plus / AK-F 14 Plus	52W [52W]	70W[70W]
AK 28 Plus / AK-F 28 Plus	61W[30,5W]	92W[46W]
AK 42 Plus / AK-F 42 Plus	70W[23W]	113W[36,5W]
AK 56 Plus / AK-F 56 Plus	79W[19,5W]	134W[33,5W]



1) Verification of the maximum power output characteristics (P_{de}) for universal housings - GP housings

The verification of the heating for GP empty housings and GP basic housings was carried out with AK distribution boards with substitute resistors, which created the maximum power loss for each standard rail as listed in the table. In doing so the outer surface does not heat up by more than 30K. Here, the temperature rise inside the housing is higher and may exceed the permissible operating temperature of the operating equipment used.

2) Verification of the heating of the housing for pre-defined equipment installations - PD housings

The verification of the heating for PD empty housings and PD basic housings was carried out with AK distribution boards with a combination of operating equipment, which created the maximum power losses for each standard rail as listed in the table. In doing so the outer surface does not heat up by more than 40K. Here, the temperature rise inside the housing is higher and may exceed the permissible operating temperature of the operating equipment used.

Power loss information
for AK/AKi installation
distribution boards
and individually mounted
AK/AKi/GTi empty enclosures

Permissible power loss P_{per} in Watts per DIN VDE 0660-507 for **individually mounted, surface-mounted installation distribution boards** and **surface-mounted empty enclosures** with stipulated ΔT . Power loss at 50% housing height and [75%] housing height.

Table 4

Type	individually mounted							
	[W]							
	$\Delta T= 10K$	$\Delta T= 20K$	$\Delta T= 30K$	$\Delta T= 40K$				
AK 03 / AKi 03	2,4 [1,8]	5,7 [4,4]	9,4 [7,2]	13,4 [10,4]				
AK 05 / AKi 05	3,8 [2,9]	9,0 [6,9]	14,9 [11,5]	21,4 [16,4]				
AK 09 / AKi 09	5,0 [4,1]	11,8 [9,6]	19,5 [15,9]	27,9 [22,8]				
AK 12 / AKi 12	5,7 [4,8]	13,6 [11,4]	22,5 [18,9]	32,2 [27,1]				
AK 24 / AKi 24	8,9 [6,9]	21,2 [16,4]	35,1 [27,2]	50,2 [38,8]				
	Traverse mounting				Vertical mounting			
	[W]				[W]			
	$\Delta T= 10K$	$\Delta T= 20K$	$\Delta T= 30K$	$\Delta T= 40K$	$\Delta T= 10K$	$\Delta T= 20K$	$\Delta T= 30K$	$\Delta T= 40K$
AK 14 L / AK-F 14 L / AK-F / DMS 14 L	9,7 [8,0]	23,0 [18,8]	38,0 [31,2]	54,4 [44,6]	9,7 [8,0]	23,0 [18,8]	38,0 [31,2]	54,4 [44,6]
AKL 1-g/t / AKi 1-g/t	5,7 [5,0]	13,4 [11,9]	22,2 [19,7]	31,7 [28,2]	5,9 [4,5]	14,0 [10,6]	23,2 [17,5]	33,2 [25,0]
AKL 2-g/t / AKi 2-g/t	8,9 [7,3]	21,1 [17,2]	35,0 [28,5]	50,1 [40,8]	8,9 [7,3]	21,1 [17,2]	35,0 [28,5]	50,1 [40,8]
AKL 2-g/t-h / AKi 2-g/t-h / AKi-Z 2	11,3 [9,2]	26,8 [21,8]	44,3 [36,1]	63,4 [51,7]	11,3 [9,2]	26,8 [21,8]	44,3 [36,1]	63,4 [51,7]
AKL 3-g/t / AKi 3-g/t	11,8 [10,2]	28,0 [24,1]	46,4 [39,9]	66,4 [57,0]	12,1 [9,3]	28,6 [22,1]	47,4 [36,6]	67,8 [52,4]
AKL 3-g/t-h / AKi 3-g/t-h / AKi-Z 3	14,7 [12,6]	34,7 [29,8]	57,5 [49,4]	82,3 [70,7]	15,1 [11,6]	35,7 [27,5]	59,0 [45,6]	84,4 [65,2]
AKL4-g/t / AKi 4-g/t	14,7 [13,0]	34,8 [30,9]	57,6 [51,1]	82,4 [73,1]	15,2 [11,4]	35,9 [27,1]	59,5 [44,8]	85,1 [64,1]
AKL 4-g/t-h / AKi 4-g/t-h / AKi-Z 400/*	18,0 [15,9]	42,5 [37,7]	70,4 [62,5]	100,8 [89,4]	18,7 [14,1]	44,4 [33,4]	73,5 [55,3]	105,1 [79,1]
SVi Enclosure (150 x 300 x 137 mm)	5,8 [5,1]	13,7 [12,1]	22,7 [20,1]	32,4 [28,7]	6,1 [4,6]	14,3 [10,8]	23,7 [17,9]	34,0 [25,6]
SVi Enclosure (150 x 300 x 162 mm)	6,4 [5,6]	15,1 [13,4]	24,9 [22,1]	35,6 [31,6]	6,7 [5,0]	15,8 [11,9]	26,2 [19,7]	37,5 [28,2]
SVi LQ Enclosure (150 x 150 x 137 mm)	3,7 [3,0]	8,8 [7,2]	14,5 [11,8]	20,8 [16,9]	3,7 [3,0]	8,8 [7,2]	14,5 [11,8]	20,8 [16,9]
GTi 1 (-g)	8,8 [7,6]	20,9 [17,9]	34,6 [29,6]	49,5 [42,4]	9,1 [7,0]	21,5 [16,6]	35,5 [27,5]	50,8 [39,4]
GTi 1 (-g) w. frame	10,9 [9,3]	25,7 [22,0]	42,6 [36,5]	60,9 [52,2]	11,2 [8,7]	26,5 [20,6]	43,9 [34,0]	62,8 [48,7]
GTi 2 (-g)	11,3 [9,2]	26,8 [21,8]	44,3 [36,1]	63,4 [51,7]	11,3 [9,2]	26,8 [21,8]	44,3 [36,1]	63,4 [51,7]
GTi 2 (-g) w. frame	13,7 [11,2]	32,5 [26,5]	53,8 [43,9]	77,0 [62,8]	13,7 [11,2]	32,5 [26,5]	53,8 [43,9]	77,0 [62,8]
GTi 3 (-g)	13,9 [11,9]	33,0 [28,1]	54,7 [46,5]	78,2 [66,5]	14,2 [11,1]	33,7 [26,3]	55,7 [43,5]	79,7 [62,3]
GTi 3 (-g) w. frame	16,7 [14,2]	39,6 [33,7]	65,6 [55,7]	93,8 [79,7]	17,1 [13,4]	40,5 [31,6]	67,0 [52,4]	95,9 [74,9]
GTi 4 (-g)	18,3 [16,2]	43,3 [38,4]	71,6 [63,5]	102,4 [90,9]	19,0 [14,3]	44,9 [33,8]	74,4 [56,0]	106,4 [80,1]
GTi 4 (-g) w. frame	21,6 [19,2]	51,2 [45,4]	84,8 [75,2]	121,2 [107,5]	22,6 [17,0]	53,5 [40,3]	88,6 [66,7]	126,7 [95,4]
GTi 5 (-g)	22,7 [19,4]	53,7 [46,0]	89,0 [76,2]	127,2 [108,9]	23,1 [17,9]	54,7 [42,5]	90,7 [70,3]	129,6 [100,5]
GTi 5 (-g) w. frame	26,5 [22,6]	62,7 [53,6]	103,8 [88,8]	148,4 [127,0]	27,1 [21,0]	64,1 [49,7]	106,1 [82,3]	151,8 [117,7]



* AKi-Z 410K, AKi-Z 410KK

Power loss details for AK/AKi/GTi empty enclosures mounted in groups

Permissible power loss P_{per} in Watts per DIN VDE 0660-507 for **group-mounted, surface-mounted empty enclosures** with stipulated ΔT. Power loss at 50% housing height and [75%] housing height.

Table 5 / Part 1

Type	Traverse mounting				Vertical mounting			
	[W]				[W]			
	ΔT= 10K	ΔT= 20K	ΔT= 30K	ΔT= 40K	ΔT= 10K	ΔT= 20K	ΔT= 30K	ΔT= 40K
AKL 1-g/t	4,2	9,9	16,3	23,4	4,4	10,4	17,2	24,5
	[3,7]	[8,8]	[14,5]	[20,7]	[3,3]	[7,8]	[12,9]	[18,5]
AKL 2-g/t	7,0	16,5	27,4	39,1	7,0	16,5	27,4	39,1
	[5,7]	[13,5]	[22,3]	[31,9]	[5,7]	[13,5]	[22,3]	[31,9]
AKL 2-g/t-h	8,3	19,6	32,4	46,4	8,3	19,6	32,4	46,4
	[6,7]	[16,0]	[26,4]	[37,8]	[6,7]	[16,0]	[26,4]	[37,8]
AKL 3-g/t	9,5	22,5	37,2	53,2	9,7	22,9	38,0	54,3
	[8,2]	[19,3]	[32,0]	[45,7]	[7,5]	[17,7]	[29,3]	[42,0]
AKL 3-g/t-h	11,0	26,1	43,2	61,8	11,3	26,8	44,4	63,4
	[9,5]	[22,4]	[37,1]	[53,1]	[8,7]	[20,7]	[34,3]	[49,0]
AKL4-g/t	12,0	28,3	46,9	67,0	12,3	29,2	48,3	69,1
	[10,6]	[25,1]	[41,6]	[59,5]	[9,3]	[22,0]	[36,4]	[52,0]
AKL 4-g/t-h	13,7	32,4	53,7	76,8	14,3	33,8	56,0	80,1
	[12,2]	[28,8]	[47,7]	[68,2]	[10,8]	[25,5]	[42,2]	[60,3]
AKi 1-g/t	4,2	9,9	16,3	23,4	4,4	10,4	17,2	24,5
	[3,7]	[8,8]	[14,5]	[20,7]	[3,3]	[7,8]	[12,9]	[18,5]
AKi 2-g/t	7,0	16,5	27,4	39,1	7,0	16,5	27,4	39,1
	[5,7]	[13,5]	[22,3]	[31,9]	[5,7]	[13,5]	[22,3]	[31,9]
AKi 2-g/t-h / AKi-Z 2	8,3	19,6	32,4	46,4	8,3	19,6	32,4	46,4
	[6,7]	[16,0]	[26,4]	[37,8]	[6,7]	[16,0]	[26,4]	[37,8]
AKi 3-g/t	9,5	22,5	37,2	53,2	9,7	22,9	38,0	54,3
	[8,2]	[19,3]	[32,0]	[45,7]	[7,5]	[17,7]	[29,3]	[42,0]
AKi 3-g/t-h / AKi-Z 3	11,0	26,1	43,2	61,8	11,3	26,8	44,4	63,4
	[9,5]	[22,4]	[37,1]	[53,1]	[8,7]	[20,7]	[34,3]	[49,0]
AKi 4-g/t	12,0	28,3	46,9	67,0	12,3	29,2	48,3	69,1
	[10,6]	[25,1]	[41,6]	[59,5]	[9,3]	[22,0]	[36,4]	[52,0]
AKi 4-g/t-h / AKi-Z 400/*	13,7	32,4	53,7	76,8	14,3	33,8	56,0	80,1
	[12,2]	[28,8]	[47,7]	[68,2]	[10,8]	[25,5]	[42,2]	[60,3]
SVi (150 x 300 x 137 mm)	3,6	8,5	14,1	20,2	3,8	9,0	15,0	21,4
	[3,2]	[7,6]	[12,5]	[17,9]	[2,9]	[6,8]	[11,3]	[16,1]
SVi (150 x 300 x 162 mm)	3,9	9,3	15,4	22,0	4,2	9,9	16,4	23,4
	[3,5]	[8,2]	[13,6]	[19,5]	[3,1]	[7,4]	[12,3]	[17,6]
SVi LQ (150 x 150 x 137 mm)	2,3	5,4	8,9	12,8	2,3	5,4	8,9	12,8
	[1,9]	[4,4]	[7,3]	[10,4]	[1,9]	[4,4]	[7,3]	[10,4]
GTi 1 (-g)	6,5	15,3	25,4	36,3	6,6	15,7	26,1	37,3
	[5,5]	[13,1]	[21,7]	[31,0]	[5,2]	[12,2]	[20,2]	[28,9]
GTi 1 (-g) w. frame	7,6	17,9	29,7	42,5	7,8	18,5	30,7	43,9
	[6,5]	[15,3]	[25,4]	[36,3]	[6,1]	[14,4]	[23,8]	[34,0]
GTi 2 (-g)	8,5	20,2	33,5	47,9	8,5	20,2	33,5	47,9
	[7,0]	[16,5]	[27,3]	[39,0]	[7,0]	[16,5]	[27,3]	[39,0]
GTi 2 (-g) w. frame	9,9	23,3	38,7	55,3	9,9	23,3	38,7	55,3
	[8,0]	[19,0]	[31,5]	[45,1]	[8,0]	[19,0]	[31,5]	[45,1]
GTi 3 (-g)	10,8	25,5	42,2	60,3	11,0	26,0	43,0	61,5
	[9,1]	[21,7]	[35,9]	[51,3]	[8,6]	[20,3]	[33,6]	[48,0]
GTi 3 (-g) w. frame	12,3	29,0	48,1	68,7	12,5	29,7	49,2	70,3
	[10,4]	[24,7]	[40,9]	[58,4]	[9,8]	[23,2]	[38,4]	[54,9]
GTi 4 (-g)	14,4	34,0	56,4	80,6	14,9	35,3	58,5	83,6
	[12,8]	[30,2]	[50,0]	[71,5]	[11,2]	[26,6]	[44,0]	[62,9]
GTi 4 (-g) w. frame	16,2	38,3	63,4	90,7	16,9	40,1	66,3	94,9
	[14,3]	[34,0]	[56,2]	[80,4]	[12,7]	[30,2]	[49,9]	[71,4]
GTi 5 (-g)	18,4	43,5	72,0	102,9	18,7	44,2	73,3	104,8
	[15,7]	[37,2]	[61,6]	[88,1]	[14,5]	[34,3]	[56,8]	[81,3]
GTi 5 (-g) w. frame	20,4	48,3	79,9	114,3	20,8	49,4	81,7	116,9
	[17,4]	[41,3]	[68,4]	[97,8]	[16,2]	[38,3]	[63,4]	[90,6]

* AKi-Z 410K, AKi-Z 410KK

Power loss details for STV empty enclosures

Permissible power loss P_{per} in Watts per DIN VDE 0660-507 for **surface-mounted empty enclosures** with stipulated ΔT . Power loss at 50% housing height and [75%] housing height.

Table 5 / Part 2

Type	[W]			
	$\Delta T= 10K$	$\Delta T= 20K$	$\Delta T= 30K$	$\Delta T= 40K$
STV 502-L / -S	3,8	9,0	14,9	21,4
	[2,9]	[6,9]	[11,5]	[16,4]
STV 512-L / -S	6,5	15,4	25,5	36,5
	[5,1]	[12,1]	[20,0]	[28,6]
STV 904-L / -S	5,0	11,8	19,5	27,9
	[4,1]	[9,6]	[15,9]	[22,8]
STV 912-L / -S STV 922-L / -S STV 923-L / -S	8,3	19,7	32,6	46,6
	[6,3]	[14,8]	[24,5]	[35,1]
STV 1222-L / -S STV 1208-L / -S STV 1224-L / -S / -S32	9,5	22,5	37,3	53,3
	[7,3]	[17,3]	[28,6]	[40,9]



Power loss details for individually mounted TK empty enclosures

Permissible power loss P_{per} in Watts per DIN VDE 0660-507 for **individually-mounted empty enclosures** with stipulated ΔT . Power loss at 50% housing height and [75%] housing height.

Table 6 / Part1

Type	Traverse mounting				Vertical mounting			
	[W]				[W]			
	$\Delta T= 10K$	$\Delta T= 20K$	$\Delta T= 30K$	$\Delta T= 40K$	$\Delta T= 10K$	$\Delta T= 20K$	$\Delta T= 30K$	$\Delta T= 40K$
TK 55-4	0,4	1,0	1,7	2,4	0,4	1,0	1,7	2,4
	[0,4]	[0,8]	[1,4]	[2,0]	[0,3]	[0,8]	[1,4]	[2,0]
TK 75-2	0,5	1,2	1,9	2,8	0,5	1,2	2,0	2,8
	[0,4]	[1,0]	[1,6]	[2,3]	[0,4]	[0,9]	[1,6]	[2,2]
TK 75-4	0,5	1,2	1,9	2,8	0,5	1,2	2,0	2,8
	[0,4]	[1,0]	[1,6]	[2,3]	[0,4]	[0,9]	[1,6]	[2,2]
TK 77-6	0,8	1,8	3,0	4,3	0,8	1,8	3,0	4,3
	[0,6]	[1,5]	[2,5]	[3,5]	[0,6]	[1,5]	[2,5]	[3,5]
TK 77-8	1,0	2,3	3,8	5,5	1,0	2,3	3,8	5,5
	[0,8]	[1,9]	[3,1]	[4,5]	[0,8]	[1,9]	[3,1]	[4,5]
TK 97-6	1,0	2,3	3,8	5,5	1,0	2,4	3,9	5,6
	[0,8]	[2,0]	[3,3]	[4,7]	[0,8]	[1,8]	[3,0]	[4,3]
TK 97-8	1,2	2,9	4,7	6,8	1,2	2,9	4,9	7,0
	[1,0]	[2,4]	[4,0]	[5,8]	[1,0]	[2,3]	[3,8]	[5,4]
TK 99-6	1,2	2,9	4,8	6,9	1,2	2,9	4,8	6,9
	[1,0]	[2,4]	[4,0]	[5,7]	[1,0]	[2,4]	[4,0]	[5,7]
TK 99-8	1,5	3,6	5,9	8,5	1,5	3,6	5,9	8,5
	[1,2]	[2,9]	[4,8]	[6,9]	[1,2]	[2,9]	[4,8]	[6,9]
TK 1005-4	0,7	1,7	2,8	4,0	0,7	1,8	2,9	4,1
	[0,6]	[1,5]	[2,5]	[3,5]	[0,6]	[1,3]	[2,2]	[3,1]
TK 1111-7	1,6	3,9	6,4	9,2	1,6	3,9	6,4	9,2
	[1,3]	[3,2]	[5,2]	[7,5]	[1,3]	[3,2]	[5,2]	[7,5]
TK 1111-9	2,0	4,6	7,7	11,0	2,0	4,6	7,7	11,0
	[1,6]	[3,8]	[6,3]	[9,0]	[1,6]	[3,8]	[6,3]	[9,0]
TK 1309-6	1,5	3,6	6,0	8,6	1,6	3,7	6,1	8,7
	[1,3]	[3,1]	[5,1]	[7,3]	[1,2]	[2,9]	[4,8]	[6,8]
TK 1309-8	1,8	4,4	7,2	10,3	1,9	4,5	7,4	10,6
	[1,6]	[3,7]	[6,2]	[8,8]	[1,5]	[3,5]	[5,8]	[8,3]
TK 1313-7	2,2	5,2	8,6	12,3	2,2	5,2	8,6	12,3
	[1,8]	[4,2]	[7,0]	[10,0]	[1,8]	[4,2]	[7,0]	[10,0]
TK 1313-10	2,6	6,0	10,0	14,3	2,6	6,0	10,0	14,3
	[2,1]	[4,9]	[8,2]	[11,7]	[2,1]	[4,9]	[8,2]	[11,7]
TK 1809-6	1,9	4,6	7,5	10,8	2,0	4,7	7,8	11,2
	[1,7]	[4,0]	[6,7]	[9,5]	[1,5]	[3,6]	[5,9]	[8,4]
TK1809-8	2,3	5,4	9,0	12,9	2,4	5,7	9,4	13,4
	[2,0]	[4,8]	[8,0]	[11,4]	[1,8]	[4,3]	[7,1]	[10,1]
TK 1811-6f	2,2	5,3	8,8	12,5	2,3	5,4	9,0	12,9
	[1,9]	[4,6]	[7,6]	[10,9]	[1,8]	[4,2]	[6,9]	[9,9]
TK 1811-8f	2,6	6,1	10,1	14,4	2,7	6,3	10,4	14,9
	[2,2]	[5,3]	[8,8]	[12,5]	[2,0]	[4,8]	[8,0]	[11,4]
TK 1811-13f	3,4	8,1	13,4	19,2	3,6	8,4	14,0	20,0
	[3,0]	[7,0]	[11,7]	[16,7]	[2,7]	[6,5]	[10,7]	[15,3]
TK 1811-9	2,7	6,3	10,5	15,0	2,8	6,5	10,8	15,5
	[2,3]	[5,5]	[9,1]	[13,0]	[2,1]	[5,0]	[8,3]	[11,9]
TK 1811-11	3,0	7,1	11,8	16,9	3,1	7,4	12,3	17,5
	[2,6]	[6,2]	[10,3]	[14,7]	[2,4]	[5,7]	[9,4]	[13,4]
TK 1811-16	3,9	9,2	15,2	21,7	4,0	9,5	15,8	22,6
	[3,4]	[8,0]	[13,2]	[18,8]	[3,1]	[7,3]	[12,1]	[17,3]

Power loss details for individually mounted TK empty enclosures

Permissible power loss P_{per} in Watts per DIN VDE 0660-507 for **individually-mounted empty enclosures** with stipulated ΔT . Power loss at 50% housing height and [75%] housing height.

Table 6 / Part2

Type	Traverse mounting				Vertical mounting			
	[W]				[W]			
	$\Delta T= 10K$	$\Delta T= 20K$	$\Delta T= 30K$	$\Delta T= 40K$	$\Delta T= 10K$	$\Delta T= 20K$	$\Delta T= 30K$	$\Delta T= 40K$
TK 1813-9	3,0	7,0	11,7	16,7	3,0	7,2	11,9	17,0
	[2,5]	[6,0]	[9,9]	[14,2]	[2,4]	[5,6]	[9,3]	[13,3]
TK 1813-11	3,3	7,9	13,1	18,7	3,4	8,1	13,4	19,1
	[2,8]	[6,7]	[11,1]	[15,9]	[2,7]	[6,3]	[10,4]	[14,9]
TK 1813-16	4,3	10,1	16,7	23,9	4,4	10,3	17,1	24,5
	[3,6]	[8,6]	[14,2]	[20,3]	[3,4]	[8,1]	[13,4]	[19,1]
TK 1813-6f	2,5	5,9	9,8	14,0	2,5	6,0	10,0	14,3
	[2,1]	[5,0]	[8,3]	[11,9]	[2,0]	[4,7]	[7,8]	[11,1]
TK 1813-8f	2,9	6,8	11,2	16,1	2,9	6,9	11,5	16,4
	[2,4]	[5,8]	[9,6]	[13,7]	[2,3]	[5,4]	[9,0]	[12,8]
TK 1813-13f	3,8	8,9	14,8	21,2	3,9	9,2	15,2	21,7
	[3,2]	[7,6]	[12,6]	[18,0]	[3,0]	[7,2]	[11,9]	[17,0]
TK 1818-6f	3,2	7,5	12,5	17,8	3,2	7,5	12,5	17,8
	[2,6]	[6,1]	[10,2]	[14,6]	[2,6]	[6,1]	[10,2]	[14,5]
TK 1818-8f	3,6	8,5	14,2	20,2	3,6	8,6	14,2	20,3
	[2,9]	[7,0]	[11,6]	[16,5]	[2,9]	[7,0]	[11,5]	[16,5]
TK 1818-13f	4,7	11,1	18,3	26,2	4,7	11,1	18,3	26,2
	[3,8]	[9,0]	[15,0]	[21,4]	[3,8]	[9,0]	[14,9]	[21,4]
TK 1818-9	3,7	8,8	14,6	20,9	3,7	8,8	14,6	20,9
	[3,0]	[7,2]	[11,9]	[17,1]	[3,0]	[7,2]	[11,9]	[17,0]
TK 1818-11	4,2	9,8	16,3	23,3	4,2	9,8	16,3	23,3
	[3,4]	[8,0]	[13,3]	[19,0]	[3,4]	[8,0]	[13,3]	[19,0]
TK 1818-16	5,2	12,4	20,5	29,3	5,2	12,4	20,5	29,4
	[4,3]	[10,1]	[16,7]	[23,9]	[4,3]	[10,1]	[16,7]	[23,9]
TK 2518-6f	4,0	9,6	15,8	22,7	4,1	9,7	16,1	23,0
	[3,4]	[8,2]	[13,5]	[19,3]	[3,2]	[7,6]	[12,5]	[17,9]
TK 2518-8f	4,5	10,7	17,8	25,4	4,6	10,9	18,1	25,9
	[3,9]	[9,2]	[15,2]	[21,7]	[3,6]	[8,5]	[14,1]	[20,2]
TK 2518-13f	5,8	13,6	22,6	32,3	5,9	14,0	23,1	33,1
	[4,9]	[11,6]	[19,3]	[27,6]	[4,6]	[10,9]	[18,0]	[25,8]
TK 2518-9	4,7	11,1	18,3	26,2	4,8	11,3	18,7	26,7
	[4,0]	[9,4]	[15,6]	[22,4]	[3,7]	[8,8]	[14,5]	[20,8]
TK 2518-11	5,2	12,2	20,2	29,0	5,3	12,5	20,7	29,6
	[4,4]	[10,4]	[17,3]	[24,7]	[4,1]	[9,7]	[16,1]	[23,0]
TK 2518-16	6,4	15,2	25,1	35,9	6,6	15,5	25,7	36,8
	[5,5]	[12,9]	[21,4]	[30,6]	[5,1]	[12,1]	[20,0]	[28,7]
TK 3625-11	8,4	19,8	32,8	46,9	8,5	20,2	33,4	47,7
	[7,1]	[16,9]	[28,0]	[40,0]	[6,6]	[15,7]	[26,0]	[37,1]
TK 3625-16	10,0	23,8	39,4	56,3	10,3	24,3	40,3	57,6
	[8,6]	[20,3]	[33,6]	[48,1]	[8,0]	[18,9]	[31,3]	[44,8]

Power loss details for individually mounted TK AL and TG empty enclosures

Permissible power loss Pper in Watts per DIN VDE 0660-507 for **individually-mounted empty enclosures** with stipulated ΔT . Power loss at 50% housing height and [75%] housing height.

Table 7

Type	Traverse mounting				Vertical mounting			
	[W]				[W]			
	$\Delta T= 10K$	$\Delta T= 20K$	$\Delta T= 30K$	$\Delta T= 40K$	$\Delta T= 10K$	$\Delta T= 20K$	$\Delta T= 30K$	$\Delta T= 40K$
TK-AL 77-6	1,2	2,9	4,8	6,9	1,2	2,9	4,8	6,9
	[1,0]	[2,4]	[3,9]	[5,6]	[1,0]	[2,4]	[3,9]	[5,6]
TK-AL 99-6	1,8	4,2	7,0	10,1	1,8	4,2	7,0	10,1
	[1,5]	[3,5]	[5,7]	[8,2]	[1,5]	[3,5]	[5,7]	[8,2]
TK-AL 1111-7	2,4	5,6	9,2	13,2	2,4	5,6	9,2	13,2
	[1,9]	[4,6]	[7,5]	[10,8]	[1,9]	[4,6]	[7,5]	[10,8]
TK-AL 1313-7	2,9	6,8	11,2	16,0	2,9	6,8	11,2	16,0
	[2,3]	[5,5]	[9,1]	[13,0]	[2,3]	[5,5]	[9,1]	[13,0]
TK-AL 1811-9	3,0	7,1	11,8	16,9	3,1	7,4	12,3	17,6
	[2,6]	[6,2]	[10,3]	[14,8]	[2,4]	[5,6]	[9,3]	[13,3]
TK-AL 1818-9	4,4	10,3	17,1	24,4	4,4	10,3	17,1	24,4
	[3,6]	[8,4]	[13,9]	[19,9]	[3,6]	[8,4]	[13,9]	[19,9]
TK-AL 2518-9	5,5	13,1	21,6	30,9	5,6	13,3	22,0	31,4
	[4,7]	[11,1]	[18,3]	[26,2]	[4,4]	[10,4]	[17,2]	[24,6]
TK-AL 3625-11	9,4	22,2	36,8	52,7	9,6	22,7	37,5	53,7
	[8,0]	[19,0]	[31,5]	[45,0]	[7,4]	[17,6]	[29,1]	[41,7]

Permissible power loss Pper in Watts per DIN VDE 0660-507 for **individually-mounted, surface-mounted empty enclosures** with stipulated ΔT . Power loss at 50% housing height and [75%] housing height.

Type	Traverse mounting				Vertical mounting			
	[W]				[W]			
	$\Delta T= 10K$	$\Delta T= 20K$	$\Delta T= 30K$	$\Delta T= 40K$	$\Delta T= 10K$	$\Delta T= 20K$	$\Delta T= 30K$	$\Delta T= 40K$
TG 88-6	1,0	2,4	4,0	5,8	1,0	2,4	4,1	5,8
	[0,8]	[2,0]	[3,3]	[4,7]	[0,8]	[2,0]	[3,3]	[4,7]
TG 88-9	1,3	3,2	5,3	7,5	1,3	3,2	5,3	7,5
	[1,1]	[2,6]	[4,3]	[6,1]	[1,1]	[2,6]	[4,3]	[6,1]
TG 1208-6	1,3	3,1	5,2	7,4	1,3	3,2	5,3	7,6
	[1,1]	[2,7]	[4,4]	[6,3]	[1,0]	[2,5]	[4,1]	[5,8]
TG 1208-9	1,7	4,0	6,6	9,4	1,7	4,1	6,8	9,7
	[1,4]	[3,4]	[5,6]	[8,1]	[1,3]	[3,2]	[5,2]	[7,5]
TG 1212-6	1,7	4,1	6,8	9,8	1,7	4,1	6,8	9,8
	[1,4]	[3,4]	[5,6]	[8,0]	[1,4]	[3,4]	[5,6]	[8,0]
TG 1212-9	2,2	5,2	8,5	12,2	2,2	5,2	8,6	12,2
	[1,8]	[4,2]	[7,0]	[10,0]	[1,8]	[4,2]	[7,0]	[9,9]
TG 1608-6	1,6	3,8	6,3	9,0	1,7	4,0	6,6	9,4
	[1,4]	[3,4]	[5,6]	[8,0]	[1,3]	[3,0]	[4,9]	[7,1]
TG 1608-9	2,0	4,8	7,9	11,4	2,1	5,0	8,3	11,9
	[1,8]	[4,2]	[7,0]	[10,1]	[1,6]	[3,8]	[6,3]	[9,0]
TG 1612-9	2,7	6,3	10,4	14,9	2,7	6,4	10,6	15,2
	[2,3]	[5,3]	[8,8]	[12,6]	[2,1]	[5,0]	[8,3]	[11,9]
TG 2012-8	2,8	6,7	11,0	15,8	2,9	6,9	11,4	16,3
	[2,4]	[5,8]	[9,6]	[13,7]	[2,2]	[5,3]	[8,7]	[12,4]
TG 2012-9	3,1	7,3	12,1	17,3	3,2	7,6	12,5	17,9
	[2,7]	[6,4]	[10,5]	[15,0]	[2,4]	[5,8]	[9,6]	[13,7]
TG 2015-9	3,6	8,4	14,0	20,0	3,6	8,6	14,2	20,3
	[3,0]	[7,1]	[11,8]	[16,9]	[2,8]	[6,7]	[11,1]	[15,9]
TG 2516-9	4,3	10,3	17,0	24,3	4,4	10,5	17,4	24,9
	[3,7]	[8,8]	[14,6]	[21,0]	[3,4]	[8,1]	[13,4]	[19,2]
TG 2516-12	5,0	11,8	19,6	28,0	5,1	12,2	20,2	28,8
	[4,3]	[10,2]	[16,9]	[24,2]	[4,0]	[9,4]	[15,5]	[22,2]
TG 3023-9	6,3	15,0	24,8	35,5	6,4	15,2	25,1	35,9
	[5,3]	[12,6]	[20,9]	[29,9]	[5,0]	[11,9]	[19,8]	[28,3]
TG 3023-11	6,9	16,3	27,0	38,6	7,0	16,5	27,4	39,2
	[5,8]	[13,8]	[22,8]	[32,6]	[5,5]	[13,0]	[21,5]	[30,8]

Guide values for stipulated power loss for operating equipment in the GTi and AKi products (per device), pos. **without** fuse elements. The exact data can be found in the product data for the individual products at www.spelsberg.com

Table 8

	Size	Rated current	Power loss at rated current
Component / device			
Fuse base	NH 00	160 A	12 W
	NH 1	250 A	32 W
	NH 2	400 A	45 W
Tab fuse base	NH 00	160 A	12 W
	NH 1	250 A	32 W
	NH 2	400 A	45 W
Fuse load disconnecter	NH 00	160 A	9 W
	NH 1	250 A	16 W
	NH 2	400 A	22 W
Tab fuse load disconnecter	NH 00	160 A	14 W
	NH 1	250 A	22 W
Tab screw fuse base	D02	63 A	5,5 W
	DII	25 A	4 W
	DIII	63 A	7 W
Circuit breaker		160 A	45 W
		250 A	53,4 W
		400 A	58,5 W
		630 A	123 W
Load circuit breaker		63 A	2,3 W
		80 A	1,8 W
		100 A	1,8 W
		160 A	9 W
		250 A	17,4 W
		400 A	32,4 W
		630 A	93 W

Loading factor for switchgear combinations

Example calculation:

9 NH 00 fuses with a power loss of 9 W per device.

The loading factor per EN 61439-2, table 101 is 0.7.

$$P_{\text{vred.}} = P_v \cdot \text{Rated load factor}^2$$

$$= 9 \text{ W} \cdot 0,7 \cdot 0,7 = \mathbf{4,41 \text{ W}}$$
 (per fuse)

Because 9 fuses are installed this gives:

$$P_{\text{vges}} = 4,41 \text{ W} \cdot 9$$

$$= \mathbf{36,69 \text{ W}}$$

DIN EN 61439-2, 5.4

If there is no agreement between the manufacturer of the switchgear combination and the user with regard to the actual load currents, the assumed loading of the output circuits or a group of output circuits of the switchgear combination shall be based on the values in the following table.

Type of loading	Assumed loading factor
2 and 3 circuits	0.9
4 and 5 circuits	0.8
6 and 9 circuits	0.7
10 or more circuits	0.6



1. Mounting of junction boxes on wood and other combustible materials

According to the **VdS Directive 2023**, electrical connections and conductor connections may only be installed, in the case of mounting on flammable supports, with clamps in suitable electrical installation enclosures and boxes, as outlined by **DIN VDE 0606** and **DIN EN 60670**. This is because the enclosures are closed towards the mounting surface and also because of the strict safety requirements of the standard with respect to fire resistance.

Examples:

Entire wooden buildings, buildings with wooden construction elements, wooden construction materials or other flammable materials, cavity walls constructed from flammable materials, but also synthetic heat- and sound-insulation materials.

All els installation system products meet these requirements.

2. Halogen-free installation materials

Because of the reduction in toxic materials released in the case of fire, **DIN VDE 0100-718** provides for some deviations (simplifications) from the prescribed installation methods, however, with respect to the use of halogen-free conductors. These deviations are of a highly specialised nature and are therefore not described in detail here. However, the Building Regulations of the various Federal States and other regulations for installations in public areas (rescue routes, lifts) increasingly require the use of halogen-free installation systems. In such situations, the use of high-grade, halogen-free materials is definitely advisable. The reason for this is the improved level of protection of people and materials in the case of fire, since halogen-free materials produce less smoke in the case of fire, the proportion of toxic combustion gases is reduced to a minimum and no corrosive gases are released, which can react with extinguishing agents to form hydrochloric acid. Material damage to buildings and their contents is thereby reduced.

Spelsberg offers completely halogen-free els installation systems for these areas (except HW, KD)

There are many influencing factors for outdoor installations!



3. Outdoor installation – Damp and wet areas and rooms

3.1 Basics

In general when selecting components, the manufacturer's instructions as to the product properties simply act as a guide for the user. These properties should always be viewed in the context of the relevant installation requirements such as the installation regulations according to DIN VDE 0100-ff.

Depending on the local circumstances, additional protective measures may have to be fulfilled by the user. The individual factors are described in greater detail below.

3.2 Protection against UV radiation

UV radiation can cause severe structural damage or even destruction in a wide variety of plastics. Products made from the material polystyrene (PS) must therefore not be used outdoors. Spelsberg developed the IQ series products for this scenario. A material is used for these products that has a high resistance to UV radiation. In a weathering test according to DIN 53 387 (replaced by DIN EN ISO 4892-2), this material produced optimum results in a 1000-hour test. This material also passed a weathering test according to UL 746 C, without any limitations.

3.3 Protection against high temperatures

Installed electrical appliances generate power loss during operation. The enclosures manufactured by Spelsberg are tested during the approval test for the maximum power loss in the enclosure. Detailed tables on this topic are provided in the catalogue, taking account of the ambient temperature and the installation type.

Switchgear assemblies are designed for ambient temperatures of between -25°C and +35°C (24-hour average). A temporary increase in temperature to 40°C is not a problem.

Even if, for example, IQ products from Spelsberg are suitable for temperatures of between -40°C and +80°C, the manufacturer's instructions and the requirements of the relevant product safety standards must be checked for installed devices such as line protection, fault-current circuit breakers or fuses when designing the housing.

Solar radiation or other heat sources can cause additional increases in the internal temperature which are not permitted and must therefore be avoided. Reliable operation of electrical equipment no longer be guaranteed under certain circumstances.

DIN VDE 0100-520 (VDE 0100-520):

522.1.2 Cable and conductor systems including accessories may only be installed or moved under ambient temperatures which are within the limit values specified by the manufacturer or in the relevant product standard.

3.4 Protection against chemical influences

For installations in areas with increased levels of hazardous substances in the environment, the suitability may be correspondingly reduced. Information is available in the table „Material characteristics“.

iQ products are resistant to mineral oil, vegetable fats and animal fats.

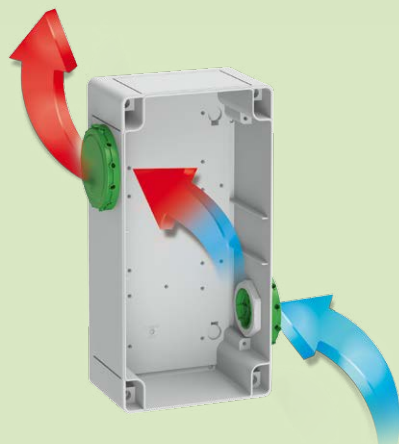
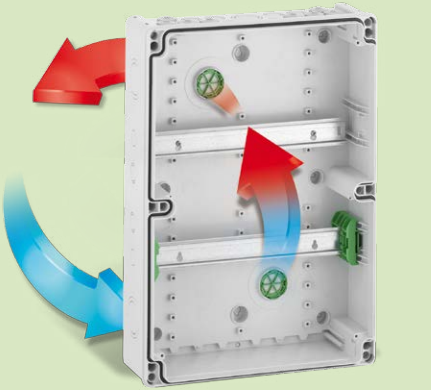

3.5 Protection against condensation

The more tightly sealed the equipment, for example junction boxes or distributor housings, the greater the likelihood of condensation forming. This is especially the case at locations where highly fluctuating temperatures are to be expected. These effects are intensified by the power loss generated in the enclosures.

Owing to the differences in temperature, a difference also arises in the pressure conditions, which causes the enclosure to draw in air when the temperature changes. The next time the temperature increases, the humidity in this air condenses on the cold surface of the housing, for example on the lid. This process is only reversible to a limited extent, so the water collects in the housing. Since this effect occurs regularly, even daily to an extent, a considerable volume of water may collect internally. If this housing has an increased protection rating, it no longer discharges this water with the result that its seal actually has a negative impact. Damage will result.

Under **DIN VDE 0100-520**, precautions must be taken with respect to drainage of water if water collects or condensation can occur within cable and conductor systems.

Spelsberg junction boxes in the various product groups have break-out condensation openings on the rear housing or mounting surfaces. These should be opened in such a way that when installed they are on the underside of the housing so that any condensation can drain off.

This only applies under the condition that no increased demands are imposed with respect to protection against accidental contact or foreign bodies (> IP2X or dust protection).

If requirements for contact protection or foreign body protection are also imposed on the housing, for example IP3X, we recommend use of els ventilation seals. These seals come in the size M20, are fitted in the corresponding cable inlet openings on the underside and the side surfaces and offer splash water protection up to IPX4 when properly installed. We recommend an installation that offers a so-called chimney effect.

AK Air and BEL Air ventilation elements

The Air ventilation elements prevent condensation, whilst maintaining the high IP65 protection rating. Any condensate occurring is transported out of the enclosure immediately via air exchange. The continuous and high rate of air exchange allows the interior air to mix constantly with the environmental air and transports the moisture outwards. Air exchange also takes place in environments with almost constant air humidity and temperature, as the air in the interior of the housing heats up, e.g. due to the components.

Recommendation: At least one complete air exchange is provided per day via the BEL Air. With one set, this is achieved with a housing volume of up to 35 dm³.

All housing parts, such as the seals, are permanently relieved of pressure through the constant pressure equalisation. The high air exchange rate guarantees a permanent exchange of the moist air with the surroundings. No appreciable pressure differences are required for this. However, with the pressure equalisation elements it is exactly these appreciable pressure differences that are required, at least temporarily, in order to implement an air exchange. The Air ventilation elements therefore have a very large, open filter surface that guarantees a high air exchange without influencing the air flow. The constant pressure equalisation prevents pressure differences thus ensuring that no mechanical forces can be exerted on the housing and seals.

DIN EN 61439-1

Section 8.2.2 concerns the protection against contact with live parts and the prevention of penetration of solid foreign objects and water. In addition, closed switchgear assemblies must be protected from condensate inside the housing without changing the type of protection.



Installation only in protected outdoor areas!

Please note that in the case of installations under solar fields, the joints between modules must not be above the housings, or the housings must also be covered by a protective shelter.



3.6 Protection against rain / snow (precipitation)

The protection rating tests carried out under DIN EN 60529 are used as comparative tests and for classification of properties. The tests are limited to a **few minutes** and cannot emulate exposure to rain / snow or cleaning with water jets. In addition, the local conditions may differ so greatly that a general exposure test cannot be defined. The installation regulations for the respective installation situation must be taken into account for this reason.

DIN VDE 0100-520:

522.3.1 Cable and conductor systems must be selected and installed such that damage cannot be caused by condensation or ingress of water.

DIN VDE 0100-712: Photovoltaic systems

712.522.8.3 External influences that can be anticipated, such as wind, ice formation, temperatures and solar radiation, must be taken into account.

3.7 Protection against retained water (frost)

Water frequently collects on surfaces and in recesses in installations that are not protected against precipitation. If this collected water cannot drain off unhindered, it will accumulate. In the event of low temperatures, this water can freeze and cause unpermitted mechanical strains on the housing. This can cause damage to the housing.

DIN VDE 0100-712:

712.522.8.3 External influences that can be anticipated, such as wind, ice formation, temperatures and solar radiation, must be taken into account. It should therefore be ensured during installation that the housing is protected by a roof construction. (See 3.6)

This roof construction may

- already be present in existing structures
- be set up by the user
- be supplied in the form of accessory products from the Spelsberg range.

3.8 Protection against plants and/or mould growth

The plastics used in electrical installation are organic materials. The risk of harm from plants, algae or mould must therefore be considered.

DIN VDE 0100-520:

522.9.1 If experience or empirical evidence shows that plants and / or mould growth can cause damage, the cable and conductor system must be selected accordingly or special protection measures must be provided.

Comment: A laying method that allows corresponding removal of such vegetation must be selected (see Section 529).

Conclusion:

Taking account of the aforementioned parameters, a protected installation is absolutely mandatory for outdoor use and is also described extensively in the installation standards. This is the only way to ensure safe operation of the protective devices.

Supplementary information on outdoor installation – UV-resistance:

The information on the type of protection and UV-resistance is often considered the only characteristics for outdoor installations. However, other factors such as absolute temperature, frequency of temperature change, humidity and chemical influences in particular play an important role with outdoor installations. In addition to impairments through UV-effects, in outdoor installations damage is expected to arise predominantly as a result of chemical influences. So, the outside areas in the vicinity of filling stations, chemical facilities, landfill sites, compressors, sewerage treatment plants etc. should be subjected to particularly critical investigations beforehand.

4. Installing cables in concrete



The commonly-used NYM sheathed cables may be installed in concrete, with the exception of concrete which is stamped or vibrated during pouring. According to **VDE 0276**, high-voltage NYY cables may, however, be used without restriction in concrete. However, in comparison with NYM, a considerably larger minimum bending radius must be complied with.

According to DIN EN 61140 (VDE 0140-1) equipment is classified into protection classes according to its construction.



Protection class I

(only symbolises the earthing, protection class I itself does not have a symbol)



Protection class II



Protection class III

5. Protection classes of electrical equipment

This classification is not for the purpose of describing the safety level of the equipment but is simply a statement of the measures with which this safety level can be achieved.

Protection Class I equipment is that in which protection against electric shock is not just provided by the basic insulation. Additional protection is provided by the fact that parts are connected to the earth lead of the fixed installation so that in case of failure of the basic insulation no voltage can remain.

Protection Class II equipment is that in which protection against electric shock is not just provided by the basic insulation but also by additional safety measures, such as double insulation or reinforced insulation. There is no possibility of connecting an earth lead.

Protection Class III equipment is that in which protection against electric shock is based on a protective low voltage (SELV¹⁾ and in which voltages that are higher than the protective low voltage cannot be produced.

All „els“ empty enclosures made from plastic comply with Class II protection requirements. Metal housings, or metal-coated housings are intended for connection of an earth lead and comply with Class I protection requirements.

¹⁾ SELV = (Safety Extra Low Voltage)

6. Protection types according to EN 60529 (VDE 0470-1)

The appropriate degree of protection is demonstrated in our in-house test laboratory. The tests are performed according to DIN EN 60670-1, DIN EN 61439-1 and DIN EN 62208 (depending on type).

The first digit of the IP Code stands for the level of protection against contact with dangerous parts and the ingress of solid bodies.



Test probe according to DIN 60529

	IP	Protection level	Definition
	0x	No contact protection, no protection against solid foreign bodies	
	1x	Protection against large area contact (with the hand), protection against foreign bodies > 50 mm Ø	The object probe, a sphere 50 mm in diameter, must not fully penetrate
	2x	Protection against contact with the fingers, protection against foreign bodies > 12 mm Ø	The object probe, a sphere 12.5 mm in diameter, must not fully penetrate
	3x	Protection against contact with tools, wires etc. > 2.5 mm Ø, protection against foreign bodies > 2.5 mm Ø	The object probe, a sphere 2.5 mm in diameter, must not penetrate at all
	4x	Protection against contact with tools, wires etc. > 1 mm Ø, protection against foreign bodies > 1 mm Ø	The object probe, a sphere 1.0 mm in diameter, must not penetrate at all
	5x	Contact protection, protection against dust deposits on the inside	The ingress of dust is not totally prevented, but dust must not penetrate in a quantity to interfere with satisfactory operation of the devices
	6x	Full contact protection, protection against ingress of dust	No penetration of dust

Spelsberg-products with NEMA protection class

Els-products	Nema
TK PC-o	4X, 12
TK PC-m	4X, 12K
TG PC-o	12*

*on request TG PC-o in Nema 4X, 12 design

Comparison table between IP code and NEMA types





IEC 60529	Nema 250													IEC 60529	
	1	2	3	3R	3S	4	4X	5	6	6P	12	12K	13		Water
															x8
															x7
6x															x6
5x															x5
4x															x4
3x															x3
2x															x2
1x															x1
0x															x0
IP	21	22	55	24	55	66	66	53	67	68	54	54	54		

Interpretationrule

Technical appendix, Index of order numbers

The second digit of the IP code stands for the level of protection against the harmful ingress of water.

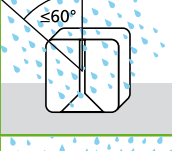
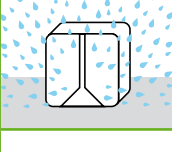
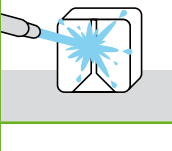
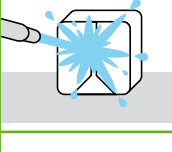
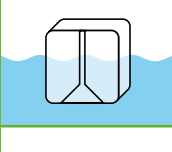
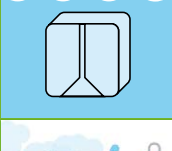

	IP	Protection level	Definition
	x0	no protection	
	x1	Protection against vertically falling dripping water	Vertically falling drops shall have no harmful effects
	x2	Protection against vertically falling water drops when the enclosure is tilted up to 15°	Vertically falling drops must not have any harmful effects when the enclosure is tilted up to 15° on either side of the vertical
	x3	Protection against falling spray water if angled up to 60° from the vertical	Water sprayed at an angle of up to 60° on either side of the vertical shall have no harmful effects
	x4	Protection against splash water from all directions	Water splashed on the enclosure from any direction shall have no harmful effects
	x5	Protection against jet water from all directions	Water directed at the enclosure from any direction in a jet shall have no harmful effects
	x6	Protection against heavy jet water	Water directed at the enclosure from every direction in a powerful jet shall have no harmful effects
	x7	Protection against temporary immersion in water	Ingress of water in quantities causing harmful effects shall not be possible when the enclosure is temporarily immersed in water
	x8	Protection against effects of long-term immersion in water	Ingress of water in quantities causing harmful effects shall not be possible when the enclosure is continuously immersed in water
	x9	Protection against heavy jet water (high pressure) with high temperature	Water directed at the enclosure from every direction in a powerful jet shall have no harmful effects

Outside diameter of average cable cross-sections

Cable cross section mm ²	NYM mm Ø	NYN NYCWY" mm Ø	„NYCY mm Ø	Cable cross section mm ²	NYM mm Ø	NYN NYCWY" mm Ø	„NYCY mm Ø
1 x 4	8	9	-	4 x 1,5	11	13,5	14
1 x 6	8,5	10	-	4 x 2,5	12,5	14,5	15
1 x 10	9,5	10,5	-	4 x 4	14,5	17,5	17
1 x 16	11	12	-	4 x 6	16,5	18	18
1 x 25	-	14	-	4 x 10	18,5	20	20
1 x 32	-	15	-	4 x 16	23,5	23	23
1 x 50	-	16,5	-	4 x 25	28,5	28	28
1 x 70	-	18	-	4 x 35	32	26-30	29
1 x 95	-	20	-	4 x 50	-	30-33	34
1 x 120	-	21	-	4 x 70	-	34-40	37
1 x 150	-	23	-	4 x 95	-	38-44	42
1 x 185	-	25	-	4 x 120	-	42-58	47
1 x 240	-	28	-	4 x 150	-	46-52	52
1 x 300	-	30	-	4 x 185	-	53-58	60
2 x 1,5	10	12	13	4 x 240	-	59-71	70
2 x 2,5	11	13	14	4 x 25/16	-	-	30
2 x 4	12	15	16	4 x 35/16	-	-	30
2 x 6	14	16	17	4 x 50/25	-	-	36,5
2 x 10	17	18	18	4 x 70/35	-	-	40
2 x 16	20	20	21	4 x 95/50	-	-	44,5
2 x 25	24	-	-	4 x 120/70	-	-	48,5
2 x 35	27	-	-	4 x 150/70	-	-	53
3 x 1,5	10,5	12,5	13	5 x 1,5	12	15	15
3 x 2,5	11	13	14	5 x 2,5	13,5	16	17
3 x 4	13	16	16	5 x 4	15,5	16,5	18
3 x 6	15	17	17	5 x 6	18	19	20
3 x 10	18	19	18	5 x 10	20	21	-
3 x 16	20	21	21	5 x 16	26	24	-
3 x 25	26	25	-	5 x 25	31,5	-	-
3 x 35	28	-	-	7 x 1,5	13	16	-
3 x 25/16	-	26,5	27	7 x 2,5	14,5	16,5	-
3 x 35/35	-	28	27	19 x 1,5	-	22	-
3 x 50/25	-	32	32	24 x 1,5	-	25	-
3 x 70/35	-	32-35	36				
3 x 95/50	-	37-41	40				
3 x 120/70	-	42	43				
3 x 150/70	-	46	47				
3 x 185/95	-	52	48-54				
3 x 240/120	-	57-62	60				
3 x 300/150	63-68	-					

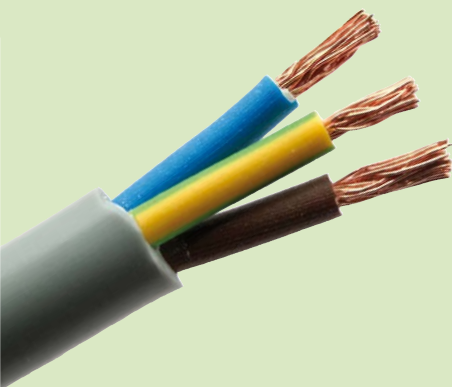

Overview of cable entries and the associated sealing ranges

Gland size	Cable gland IP68		Double-membrane seal IP66	Stepped nipple IP55	Attachment bush IP54
	Sealing range [mm]	Nenndrehmoment [Nm]	Sealing range [mm]	Sealing range [mm]	Sealing range [mm]
	M12	2 – 6,5	2	---	---
M16	4 – 10	2,5	5 – 9	---	6 – 10
M20	6 – 12	4	7 – 12	5 – 16	8 – 13,5
M20	7 – 14	4	---	---	---
M25	9 – 16	6	9 – 16	5 – 21	9 – 18,5
M32	11 – 21	7	14 – 21	13 – 26,5	13 – 23
M40	16 – 28	7,5	---	13 – 24	17 – 30
M50	21 – 34,5	8	---	---	---
M63	32 – 44,5	9	---	---	---

7. Protection against mechanical stress, IK code

According to DIN EN 50102 (VDE 0470-100) «Protection types from enclosures for electrical operating media (equipment) against external mechanical damage (IK code)», the degree of protection provided by an enclosure against mechanical damage is indicated by an IK code. The IK codes allocated to the individual stress energy values are given in the adjacent table. The data on the IK values of the individual els products is given in Table 1 (page 304).



IK-Code	stress energy [J]
IK00	---
IK01	0,15
IK02	0,2
IK03	0,35
IK04	0,5
IK05	0,7
IK06	1
IK07	2
IK08	5
IK09	10
IK10	20

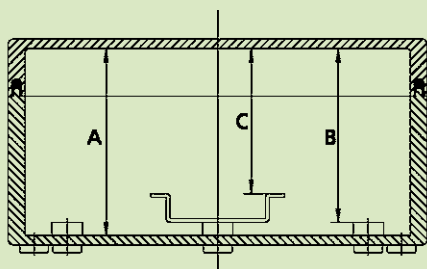

8. Installation dimensions of the els installation products

Clear installation heights of important product series

Product series	A	B	C
Abox / Abox-i	[mm]	[mm]	[mm]
Abox / Abox-i 025	42	36	---
Abox / Abox-i 040	45	39	34
Abox / Abox-i 060 / Abox SL 2,5 ²	49	49	41,5
Abox / Abox-i 100 / Abox SL 6 ²	60	60	52,5
Abox / Abox-i 160 / Abox SL 10 ²	71	71	63,5
Abox / Abox-i 250	92	92	84,5
Abox / Abox-i 350 / Abox HA	92	92	84,5
Abox 700	117,5	114	106,5
Abox / Abox-i 700 / 1500 / 2400	146	---	---

Abox m	[mm]	[mm]	[mm]
Abox 025 m / Abox 025 AB m	41,5	35,5	28
Abox 040 m / Abox 040 AB m	46	40	33

Terminal block cases	[mm]	[mm]	[mm]
RKK serie	45	45	40
RK 4/07	53	53	45,5
RK 4/12	63	63	55,5
RK 4/18, 4/25, 4/34	81	75	67,5
RK 4/50, 4/100	103	97	75,5
RKA serie / AKi-R	117,5	114	90

AK III-Serie	[mm]	[mm]	[mm]
AK 14-70	82,5	77,5	48/60
AK 05 bis 12	111	105	98,5

AK- / AKi serie	[mm]	[mm]	[mm]
AK 03	85	79	71,5
AK 05 to 12	111	105	98,5
AK 14 to 42 Plus	128	122	100
AKi 14 to 70	117,5	114	96

AKL- / AKi-empty enclosure	[mm]	[mm]	[mm]
AKL 1 to 4 / AKi 1 to 4	117,5	114	106,5
AKL 2-h to 4-h / AKi 2-h to 4-h	194,5	191	183,5

SVi empty enclosure	[mm]	[mm]	[mm]
SVi Hight 137mm	119	111,5	—
SVi Hight 162mm	144	136,5	—

9. PE/N disconnect terminals

DIN VDE 0100-718 requires that junction boxes of the power supply are constructed such that a simple measurement of the insulation resistance of all conductors to earth is possible for each individual circuit leaving the box. For circuits with a conductor cross section less than 10 mm², this measurement must be possible without disconnecting the neutral conductor, for example by installing neutral-lead disconnect terminals. For this reason an expanded terminal compartment is provided with sufficient space for installing standard terminal blocks.

Overview of the installation areas and the recommended installation systems

	Red Range / HP Junction boxes	Abox Junction boxes	Abox-i Junction boxes	WK Junction boxes	TG / TK-PC Empty enclosures	TG-ABS / TK-PS Empty enclosures	RK / RKA Terminal block housings	AK compact Housing system	AK / AKi / SVi Housing system	GTi Housing system	STV / STG Socket combinations	HW Cavity wall installation system	IBT / IBTronic Concrete installation system
Protection against direct contact (basic protection) according to DIN VDE 0100-410	●	●	●	●	●	●	●	●	●	●	●	●	●
Rooms with baths or showers according to DIN VDE 0100-701	●	●	●	●	●	●	●	●	●	●	●	●	●
Covered swimming pools and outdoor swimming pools according to DIN VDE 0100-702			●				●		●	●	●		
Agricultural and horticultural estates according to DIN VDE 0100-705		●	●	●			●	●	●	●	●		
Electrical equipment at camping and caravan sites and similar areas according to DIN VDE 0100-708	●	●	●		●	●	●	●	●	●	●		
Electrical equipment for pleasure craft or houseboat marinas and similar areas according to DIN VDE 0100-709 Electrical equipment for caravans and motor caravans according to DIN VDE 0100-721			●						●	●	●	●	
Photovoltaic systems according to DIN VDE 0100-712					●		●		●	●			
Electrical equipment in furniture according to DIN VDE 0100-724												●	
● Damp and wet environments and rooms △ Protected outdoor installations □ Unprotected outdoor installations according to DIN VDE 0100-737	●	●	● △ □ ¹⁾	●	● △	●	●	●	● △	● △	● △		
Temporary electrical equipment, for example at fairgrounds, amusement parks and circuses according to DIN VDE 0100-740	●	●	●		●	●	●	●	●	●	●		

¹⁾ only applies for Abox XT series (casting resin technique)

Additional information for outdoor installations, UV resistance:

Statements regarding the protection rating and UV resistance are often seen as the only criteria for outdoor installation.

However, other factors such as temperature, frequency of temperature change, air humidity and particularly chemical influences also play a significant role for outdoor installations. In addition to the effects of UV, chemical influences can be expected to be the main source of damage for outdoor installations. From the outset, outdoor areas of filling stations, chemical works, waste disposal sites, compressors, sewage works etc, should be examined particularly carefully.

Protection against direct contact (basic protection) under standard conditions according to DIN VDE 0100-410

Important protection requirements:

- Live parts (AC voltages higher than 50 V and DC voltages higher than 120 V) must be enclosed or mounted behind covers which at least conform to protection rating IP2X.
- Horizontal upper surfaces of covers or enclosures that are easily accessible must at least conform to protection rating IP4X.
- Covers and enclosures must be securely fixed and have sufficient strength and durability to maintain the required protection class and sufficient distance from the live components under the conditions and external influences to be expected under normal operation. The covers must only be able to be removed using tools.

All „els“ products satisfy these requirements

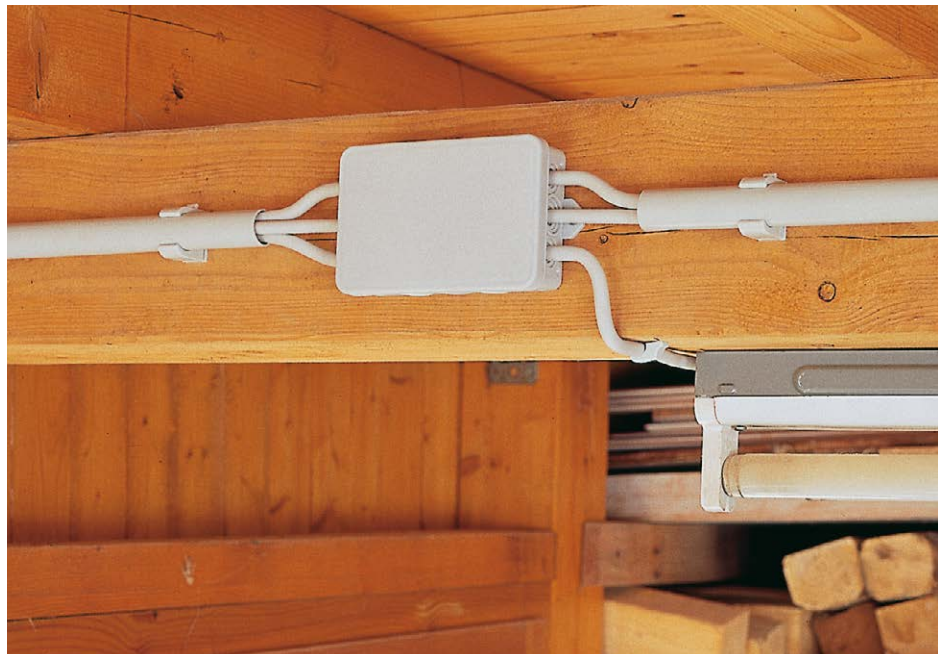

Example: Living rooms, hotel rooms, attics, heated and ventilated cellars



Rooms with bath or shower per DIN VDE 0100-701

Important protection requirements:

- The following switchgear, controllers and installation devices are permitted in these areas:

Area 0 - None.

Area 1 - Junction boxes and terminal boxes for the supply of electrical consumers that are permitted in zones 0 and 1 per 701.55.

- Installation devices, including sockets for power circuits that are protected through low voltage by means of SELV¹ or PELV² with a nominal voltage that does not exceed 25 VAC or 60 VDC. The current source must be installed outside area 0 or 1.

Area 2 - Installation devices, with the exception of sockets.

- Installation devices, including sockets for power circuits that are protected through low voltage by means of SELV¹ or PELV². The current source must be installed outside area 0 or 1.

- Shaver points per DIN EN 61558-2-5 (VDE 0570-2-5).

- Installation devices, including sockets for signalling and communications equipment assuming that such equipment is protected through low voltage by means of SELV¹ or PELV².

- Electrical equipment must have the following type of protection as a minimum:

In area 0: IPX7

In area 1: IPX4

In area 2: IPX4

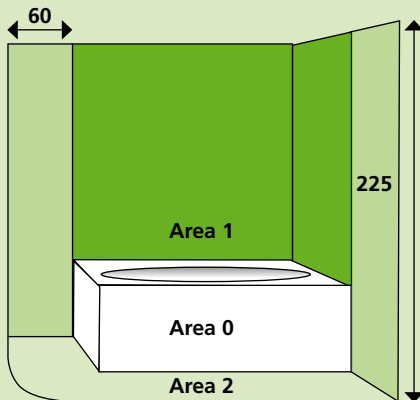

The requirements do not apply to shaver points per DIN EN 61558-2-5 (VDE 0570-2-5), that are installed in area 2 and that are unlikely to be hit by direct spray whilst showering.

Electrical equipment that is exposed to **water jets**, e.g. for cleaning purposes in public baths, must comply with **protection type IPX5** as a minimum when installed in **areas 1 and 2**.

Particularly suitable: Abox-i, AK, AKi and GTi housing systems.

¹⁾ SELV = Safety Extra Low Voltage

²⁾ PELV = Protective Extra Low Voltage

Swimming pool basins and other basins according to DIN VDE 0100-702

Important protection requirements:

- When using SELV¹, protection from direct contact must be ensured, regardless of the voltage level, though:
 - Coverings or enclosures of protection type IP2X or IPXXB (protected against access by fingers) as a minimum, or
 - Insulation that can withstand a test voltage of 500 VAC for a minimum of one minute.
- Electrical equipment must comply with the following types of protection as a minimum:

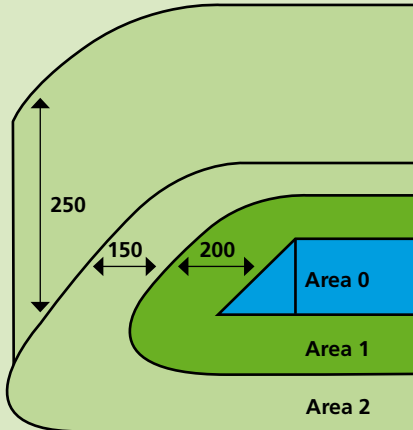

Area	Outdoors, for cleaning work <u>with</u> water jet	Outdoors, <u>without</u> water jet	Indoors, for cleaning work with water jet	Indoors, without water jet
0	IPX5/IPX8	IPX8	IPX5/IPX8	IPX8
1	IPX5	IPX4	IPX5	IPX4
2	IPX5	IPX4	IPX5	IPX2

- It is not permitted to install junction boxes in area 0. In area 1, only junction boxes for electrical circuits with protection through low voltage by means of SELV¹ are permitted.

Particularly suitable:

Abox-i, the STV range as well as the AK, AKi, GTi, TK-PC and TG-PC housing systems.

¹ SELV = Safety Extra Low Voltage



Example:

Stables, henhouses, pig-fattening units, incubation rooms and hatcheries, rooms for fodder preparation, hay-lofts, storage areas for straw, fertilizer and cereals

Note:

For installations in areas with increased levels of air contamination, the suitability may be correspondingly limited. Information is available in Table 2 (Page 305)

Agricultural and horticultural estates according to DIN VDE 0100-705

Important protection requirements:

The following shut-off equipment should be provided in circuits, regardless of which systems, depending on the type of earth connection:

- In end circuits with sockets, a fault-current circuit breaker (RCD¹) with a trip current = 30 mA
- In all other circuits, excluding those that supply distributors, fault-current circuit breakers (RCD¹) with a trip current = 300 mA.

Fault-current circuit breakers (RCD²) with a trip current = 300 mA must be set up for fire protection. The fault-current circuit breakers (RCD²) must disconnect all live conductors. In cases where improved maintenance of supply is required, these fault-current circuit breakers (RCD²) must comply with design type S or disconnect with a time delay.

In areas where there is a risk of fire, conductors for low-voltage circuits must either be supplied with covers or sheathing with protection rating IPXXD or IP4X or be supplied with sheathing made from insulating material in addition to their basic protection insulation.

Particularly suitable: STV, Abox, Abox-i, the AK, AKi, GTi, TK-PC and TG-PC housing system.

² RCD = Residual Current Device

Overview of the installation areas



Examples:

Commercial kitchens, unheated and unventilated cellar, laundry rooms, cold rooms, a wine cellar, greenhouses, laundry



Examples of unprotected outdoor installations:

Streets, paths and plazas, courtyards, passages and gardens, on construction sites, railway platforms, ramps and roofs, on cranes, construction machinery, filling stations and walls of buildings and external walls.

Examples of protected outdoor installations:

Systems in covered railway platforms, in entrance gates and covered filling stations, on houses with sufficient roof projection, with additional weather protection

Damp and wet areas and rooms and systems installed outdoors per DIN VDE 0100-737.

Important protection requirements:

- In damp and wet areas and rooms, the electrical equipment must be protected from dripping water (protection type IPX1) as a minimum.
- In areas and rooms where water will be jetted and where electrical equipment will not normally be directly jetted for cleaning purposes, the equipment must be protected from splashed water (protection type IPX4) as a minimum.

In areas and rooms where water will be jetted, electrical equipment that is directly exposed to the water stream must have a type of water protection appropriate to the type of water jet exposure or must have an additional protective measure that does not impair the operation of the equipment protected by it.

Note: The scope of protection afforded by protection type IPX5 does not permit the cleaning of the equipment with pressurised water, e.g. spraying with a water hose or with high pressure cleaners.

- Metal parts exposed to corrosive vapours or mists must be protected against corrosion, e.g. through protective coatings or by using corrosion-proof materials.

Systems installed outdoors

Important protection requirements:

- In protected outdoor systems, the equipment must be protected from dripping water (protection type IPX1) as a minimum.
- In unprotected outdoor systems, the equipment must be protected from sprayed water (protection type IPX3) as a minimum.
- The requirements for protection through automatic shutoff of the power supply for
 - sockets in outdoor installations and
 - sockets intended for the occasional supply of outdoor portable equipment, are contained in DIN VDE 0100-470 (VDE 0100 part 470):1996-02, section 471.2.3.

Particularly suitable:

Abox-i, AK, AKi, GTi, STV/STG, TG-PC and TK-PC

In unprotected outdoor areas: Abox XT

See chapter 3 (page 315 ff.) for information on outdoor installations.
In addition, ventilation and/or drainage is essential!



Electrical systems on caravan pitches, camping pitches and similar areas per DIN VDE 0100-708

Important protection requirements:

- The use of equipment with protection class 0 is not permitted.
- Equipment on a caravan pitch must have a protection type of IPX4 as a minimum in order to protect it from splashed water.
Note: If the electrical equipment will be sprayed during the washing process with high pressure cleaners etc., protection type IPX5 must be selected for the equipment itself or the use of an additional protective housing should be considered.
- Equipment that will be erected on a caravan/tent pitch must have or be provided with a protection type of IP4X as a minimum in order to protect it from penetration of very small objects.
- Equipment that will be erected on a caravan pitch must be protected against mechanical stresses.

The protection is achieved through one or more of the following measures:

- The position or location of the equipment must be selected such that damage due to any reasonably foreseeable event is avoided
- Provision of local or general mechanical protection
- Electrical equipment must be erected in compliance with a minimum protection against external mechanical stresses per IK07

Particularly suitable: Red range, Abox, Abox-i, RK, RKA, AK, AKi, GTi and the STV range.

Electrical systems for caravans and motorhomes per DIN VDE 0100-721

Important protection requirements:

- The nominal AC power supply for the caravan system must not exceed 230 V in the case of single-phase power or 400 V in the case of 3-phase power. The nominal DC power supply for the caravan system must not exceed 48V.
- Where accessories are sited in a position where moisture may be present, the accessory must be constructed or enclosed such that a protection class of no less than IP44 is achieved.

Electrical systems for water sport vehicles or houseboats, marinas and similar areas per DIN VDE0100-709

Important protection requirements:

- In marinas, equipment erected at or above a landing stage, launching point, pier or pontoon must be selected in accordance with the external influences that may occur, as follows:
 - Splashed water (AD4): IPX4
 - Water jet (AD5): IPX5
 - Waves (AD6): IPX6



- Equipment that will be erected at or above a landing stage, launching point, pier or pontoon must be selected with a protection class of at least IP4X in order to prevent penetration by very small foreign objects (AE3).
- Equipment that will be erected at or above a landing stage, launching point, pier or pontoon must be suitable for exposure to corrosive atmospheres or contaminated substances (AF2,). AF3, should be used if exposure to hydrocarbons is possible.
- Equipment that will be erected at or above a landing stage, launching point, pier or pontoon must be protected against mechanical stresses.(medium mechanical stresses AG2). The protection must be achieved through one or more of the following requirements:
 - The position or location of the equipment must be selected such that damage due to any reasonably foreseeable event is avoided
 - Provision of local or general mechanical protection
 - Equipment erected in compliance with a minimum protection against external mechanical stresses per IK07

Particularly suitable after the feed point: Abox, Abox-i, Abox XT, AK, AKi, GTi, TK-PC, TG-PC, STV, and the STG series.

¹⁾ Abbreviation for the classification of external influences per DIN VDE 0100-510, table ZA.1

Primarily electrical systems erected, for example at fairgrounds, amusement parks and circuses per DIN VDE 0100-740

Important protection requirements:

- The nominal supply voltage shall not exceed 230/400 VAC or 440 VDC.
- Regardless of the number of current sources for power supply, outer conductors and neutral conductors for the various current sources shall not be connected to one another after the feed point. The instructions from the DSO²⁾ shall be complied with.
- All final circuits for lights, sockets up to 32 A rated current and portable equipment that is connected via flexible cable or wiring with a current load capacity up to 32 A, must be additionally protected with residual current devices (RCD³⁾ with a rated fault current = 30 mA.
- Each separated electrical system and each distribution circuit that supplies an outdoor system, must be equipped with its own, easily accessible and correctly identifiable disconnection device.
- Switchgear and controllers shall only be installed in boxes that can be opened exclusively with keys or tools. Exceptions to this are parts that are intended to be operated by electrical lay-persons.
- Electrical equipment must comply with protection type IP44 as a minimum.
- Each electrical system must have its own easily-accessible device for disconnection and switching and to provide over-current protection.
- Housings that contain rectifiers and transformers must be reasonably ventilated and the openings must not be covered during operation.

Particularly suitable: Red range, Abox, Abox-i, RK, RKA, AK, AKi, GTi and the STV range.

²⁾ DSO = Distribution System Operator

³⁾ RCD = Residual Current Device



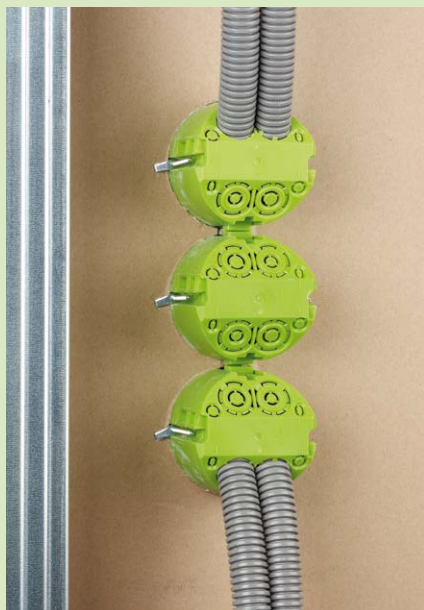

Electrical systems in furniture and similar furnishings DIN VDE 0100-724

Important protection requirements:

- Wiring must be either permanently routed or routed in suitable hollow spaces. With permanent routing, the wiring must be equipped with suitable strain relief at the point of entry to the furnishing object. With routing in hollow spaces within the furnishing object, the wiring must be equipped with suitable pushing/strain relief at the point of entry to the furnishing object and at the equipment itself.
- Junction boxes and equipment boxes, installation distribution boards and similar devices or recessed installations must comply with the test requirements for cavity wall sockets per DIN 57606 / VDE 0606 and must be marked accordingly.
- Electrical installation devices for flush-mounting must not be fastened into cavity wall sockets with claws.
- Cavity wall sockets and cavity wall distribution boards must be installed such that they are protected from mechanical damage.
- Note: This can be done by means of installation in inaccessible cavities, in recesses or through additional mechanical protection, for example.

Particularly suitable: The cavity wall socket range



Photovoltaic systems per DIN VDE 0100-712

The peripherals for photovoltaic systems are generally installed outdoors. For this reason, the following important protection requirements apply:

- External influences that are to be expected such as wind, ice formation, temperature and solar radiation must be taken into account.
- The heat arising from direct solar radiation in photovoltaic systems must be reliably dissipated.
- All terminal boxes (PV generator terminal boxes and PV sub-array terminal boxes) must be equipped with a warning that active components in the terminal boxes may still be live after being separated from the PV inverter.
- The requirements for switching off the PV system for maintenance work are contained in VDE 0100-712, section 53.

Particularly suitable: RK-PV, AK, AKi, GTi,TK-PC and TG-PC

See chapter 3 (page 305 ff.) for information on outdoor installations.
In addition, ventilation and/or drainage is essential!



The mentioned tests are based on the following standards:

- DIN EN 60670-1 (VDE 0606-1),
- DIN EN 61439-1 (VDE 0660-600-1),
- DIN EN 62208 (VDE 0660-511)

with all associated amendments and extensions.

The tests described below are carried out, documented, analysed and evaluated there.

- **DIN EN 60670-1, VDE 0606-1**

This standard applies for sockets, housings and housing parts for electrical installation equipment with a rated voltage of less than 1000 VAC and 1500 VDC, which are intended for household and similar fixed electrical installations both indoors and outdoors.

(DIN EN 60670-1, 1 Application Area)

- **DIN EN 61439-1, VDE 0660-600-1**

This standard defines terms and specifies the operating conditions, construction requirements, technical characteristics and requirements for certification of low-voltage switch gear assemblies whose rated voltage is below 1000 VAC and 1500 VDC and which are movable or fixed. (DIN EN 61439-1, 1 Application Area)

- **DIN EN 62208, VDE 0660-511**

This standard applies for empty enclosures, as supplied by the manufacturer before any equipment is installed by the manufacturer of the switchgear assembly.

(DIN EN 62208, 1 Application Area)

Note:

Our in-house testing laboratory is certified according to:

- UL (Underwriters Laboratories)
- DIN EN 60670-1, 60670-22, 60529

The tests described below are carried out, documented, analysed and evaluated there.



Prüfsonden nach DIN EN 60529

Proof of mechanical structure

DIN EN 60670-1:

Lids, covers or cover plates or parts thereof

DIN EN 61439-1:

Design verification of switchgear assemblies

DIN EN 62208:

Type testing of empty enclosures

Proof of non-removable lids

DIN EN 60670-1

The forces are applied perpendicular to the mounting surface, at the middle of the lid, gradually increasing for one minute.

Proof of removable lids

DIN EN 60670-1

The forces are applied ten times, gradually increasing, to the device to remove the lid. The equipment under test shall be free of damage afterwards.

Proof of resistance to ingress of solid foreign bodies

DIN EN 60670-1

DIN EN 62208, 9.8.1.2

The equipment under test is set up as in normal use and any existing cable inlets are fitted with cables. Protection is achieved if the probe cannot penetrate into the tested equipment (IP4X).

For protection level IP5X, no part of the inner surface may be covered by dust from the outside. For protection level IP6X, no dust may penetrate the into the tested equipment. (See IP code, page 309)



Proof of resistance to harmful effects of water ingress

DIN EN 60670-1:

DIN EN 61439-1:

DIN EN 62208:

The equipment under test is set up as in normal use and any existing cable inlets are fitted with cables. The equipment under test then has amounts of water applied in accordance with its protection rating (see IP code, page 309). The ingress of water is detected by lining the interior of the equipment under test with absorbent paper. The indicator paper is examined immediately after the test.

Proof of the strength of materials and parts

DIN EN 60670-1:

Mechanical strength of boxes and enclosures

DIN EN 61439-1:

Corrosion resistance of switchgear assemblies

DIN EN 62208, 9.13

Corrosion resistance of empty enclosures

Proof of heat resistance

DIN EN 60670-1:

A steel ball with a 5-mm diameter is pressed down on the surface of the box or enclosure with a force of 20 ± 2 N. This formation is set up in a heating cabinet and left there for an hour at a temperature of $125 \pm 2^\circ\text{C}$. After the time has elapsed, the equipment under test must be cooled to room temperature within 10 seconds by immersing it in a water tank. Proof is furnished if the diameter of the impression left behind by the sphere is not larger than 2 mm.

Tests and test methods according to IEC-/EN-Standard



Start of test

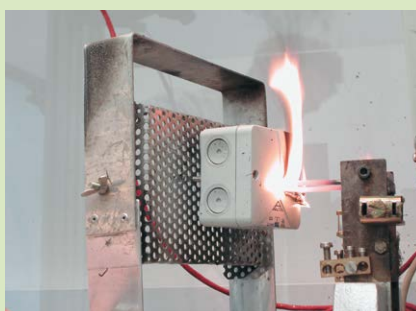

End of test



Proof of durability of plastics against excessive heat and fire

DIN EN 60670-1:

DIN EN 61439-1:

DIN EN 62208:

The resistance is determined by the glow wire test. The equipment under test is brought into contact with the hot filament for 30 seconds. The temperature amounts to:

- 960 ± 15 °C for parts containing live components,
- 850 ± 15 °C for cavity wall parts,
- 650 ± 15 °C for all others.

The test is passed if the housing does not burn or glow or if the flames and the glow extinguish independently 30 seconds after removal of the glow wire. The tissue paper spread below the test set must not be ignited by falling parts.

Proof of electrical stability

DIN EN 60670-1:

Insulation resistance and electric strength of boxes and enclosures

DIN EN 61439-1:

Protection against electric shock and continuity of earth leads in switchgear assemblies

DIN EN 62208:

Proof of insulation resistance of empty enclosures

Proof of protection against electric shock

DIN EN 61439-1:

DIN EN 62208:

The test must demonstrate that all conductive parts of the device are effectively connected to the external earth lead. A resistance meter must be used here, which can supply at least 10 A. The test must result in a circuit resistance of $\leq 0.1 \Omega$.

Proof of electric strength

DIN EN 60670-1:

The test voltage is applied between two metal foils as for proof of insulation resistance. The test starts with about half the specified voltage and then increases rapidly to full voltage. The test is passed if no breakdown or flashover occurs.

Rated insulation voltage [V]	Test voltage [V]	Test voltage protection class II [V]
130	1250	1875
> 130 and ≤ 250	2000	3000
> 250 and ≤ 450	2500	3750
> 450 and ≤ 750	3000	4500
> 750	3500	5250

DIN EN 61439-1:

The test voltage is applied

- between the connected poles of the main circuit and the earthed enclosure,
- between the unconnected poles of the main circuit,
- between the control and auxiliary circuit and the main circuit as well as the earthed enclosure.

In order to furnish proof, the overcurrent relay must not trigger and there should be no breakdown.

Rated insulation voltage (phase-to-phase) [V]	Insulation test voltage (AC) [V]	Insulation test voltage (DC) [V]
$U_i \leq 60$	100	1415
$60 < U_i \leq 300$	150	2120
$300 < U_i \leq 690$	1890	2670
$690 < U_i \leq 800$	2000	1830
$800 < U_i \leq 1000$	2200	3110
$1000 < U_i \leq 1500$	---	3820

Rated insulation voltage (phase-to-phase) [V]	Insulation test voltage (AC) [V]
$U_i \leq 12$	250
$12 < U_i \leq 60$	500
$60 < U_i$	$2 \cdot U_i + 1000$ min. 1500

Proof of clearances and creepage distances and distances through casting compound

DIN EN 60670-22:

DIN EN 61439-1:

The intervals may not be less than described in Table 21 and are measured between live parts of different polarity, live parts and metal caps or sockets without insulation and live parts and the base mounting surface.

Rated insulation voltage [V]	Creepage distances, clearances and distances through casting compound [mm]
≤ 130	1,5
> 130 and ≤ 250	3
> 250 and ≤ 450	4
> 450 and ≤ 750	6
> 750	8

The clearances and creepage distances are evaluated as follows:

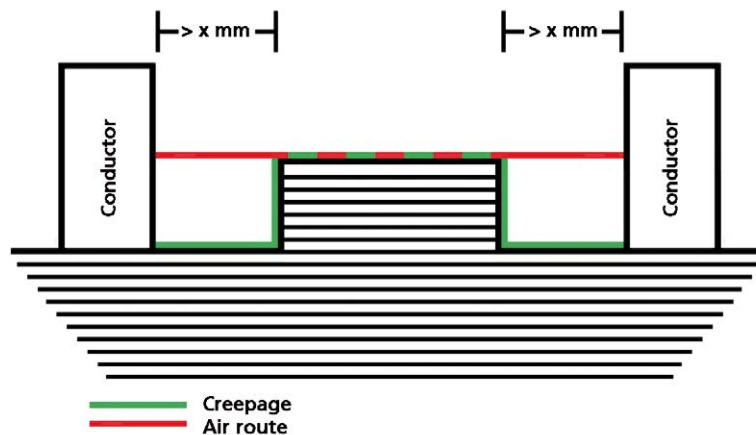

The distance x must be between 0.25 mm and 2.5 mm depending on the degree of contamination (see Table 22), otherwise it may not be used to extend the creepage. In this case, the creepage distance would be equal to the clearance, based on the example in the figure above (DIN EN 61439-1, Appendix F).

Degree of contamination	Smallest width x of grooves [mm]
1	0,25
2	1
3	1,5
4	2,5



**Underwriters
Laboratories**

Tests and test methods UL – Underwriters Laboratories

The tests referred to are based on the following standards:

- **UL 94**
- **UL 50**
- **UL 746C**

with all associated amendments and extensions.

UL 94

„Tests for Flammability of Plastic Materials for Parts in Devices and Applications“

This regulation describes the test for evaluating and classifying the flammability of plastics.

UL 50

„Standard for electrical equipment intended to be installed and used in non-hazardous locations“

This regulation sets standards for electrical appliances that are not intended for use in areas subject to explosion hazards.

UL 746C

„Standard for safety for polymeric materials – use in electrical equipment evaluations“

This regulation sets standards for materials made of polymer, for use in electrical equipment.



Tests for Flammability of Plastic Materials for Parts in Devices and Applications.

UL 94

The test is conducted with an open flame. Depending on the classification, the flame has a power of 50 watts (20 mm high flame) or 500 watts (125 mm high flame). The ignition source acts on the test object for 30 s in the case of the horizontal burning test (HB), twice for 10 s with the vertical burn test (V) and five times for 5 s with the 5V test and is then removed again. The burning time and also the fragmentation of burning parts in the case of V-tests are assessed. A cotton ball placed under the test set must not ignite.

Classifications:

A material sample (thickness <3 mm) is placed horizontally above a 50 W flame 20 mm high.

Classification	Conditions
HB	Self-extinguishing
HB75	Burning < 75 mm/min.
HB45	Burning < 40 mm/min.

A material sample is placed vertically above a flame with 50W power and a height of 20 mm.

Classification	Conditions
V-2	Self-extinguishing up to 30 s following removal of the flame, burning drops permitted
V-1	Self-extinguishing up to 30 s following removal of the flame, no burning drops permitted
V-0	Self-extinguishing up to 10 s following removal of the flame, no burning drops permitted

A material sample is placed vertically above a 500 W flame with a height of 125 mm ± 10 mm.

Classification	Conditions
5VB	Self-extinguishing, no burning drops, burn holes are permitted
5VA	Self-extinguishing, no burning drops, burn holes are not permitted

Note:

As an alternative to materials with the material classification 5VA, the UL 50 regulation also permits material that has the classification HB and has passed the flame test according to UL 746C, Selection 17 „Flammability 127 mm (5 inch) flame“. The material thus tested is comparable to material with the classification 5VA according to UL 50.

Test of proof against mechanical stress



UL 746C

In order to prove protection against mechanical stress, impact stress must be applied to the equipment under test.

Equipment intended for outdoor use is cooled for three hours in a cold chamber at $-35 \pm 2^{\circ}\text{C}$ and then mounted on a rigid frame appropriate to its planned use. In the cold state, a single blow is applied with a steel ball of 50.8 mm (2 inches) in diameter and weighing 0.535 kg (1.18 pounds) to the surface being tested.

In order to furnish proof, the equipment under test must be free of any damage that may interfere with its proper use. Furthermore, the intended protection rating must not be changed negatively.



The splinters are ice residue from the cooling process at -35°C .

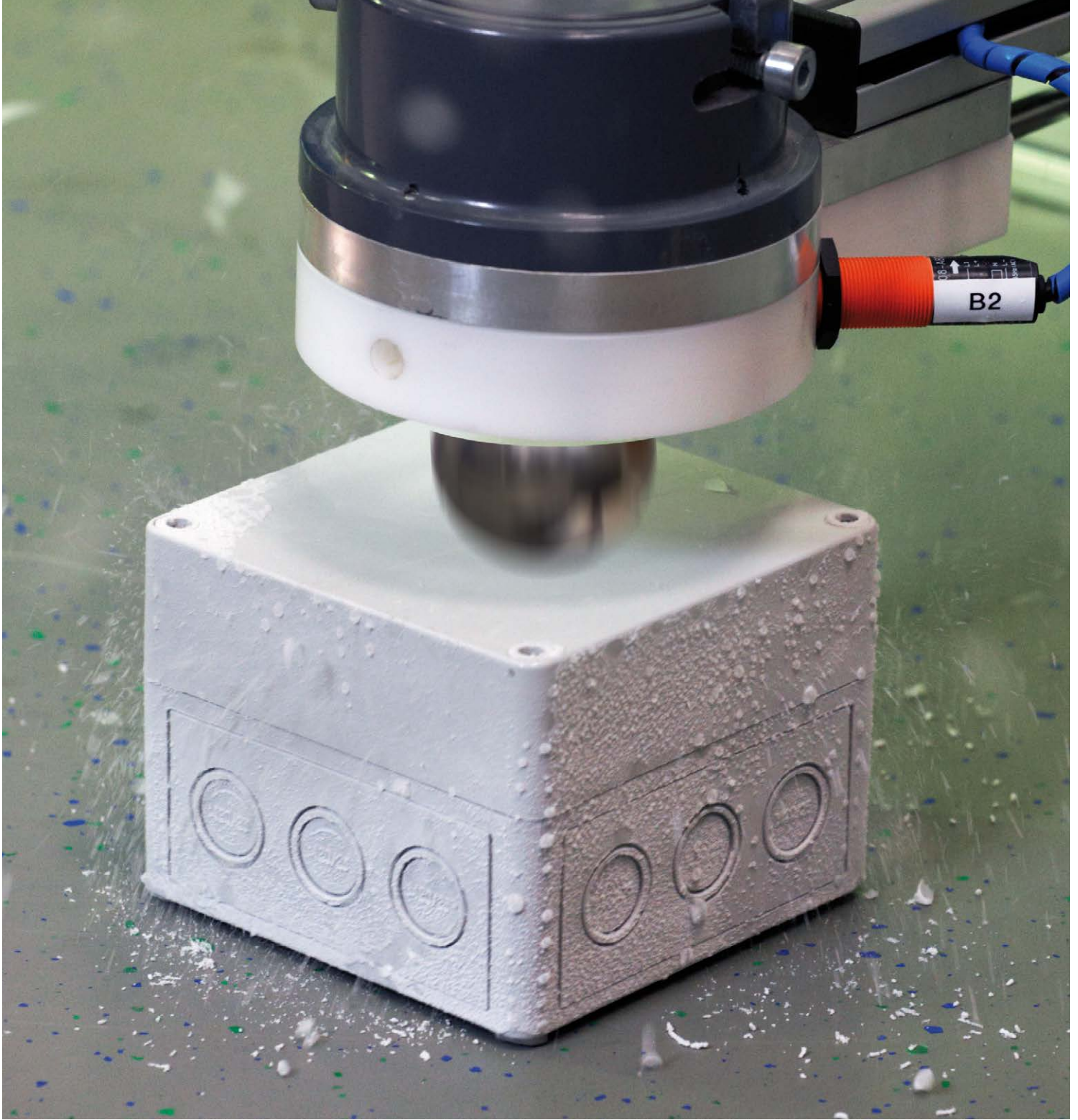

Network types according to DIN VDE 0100-310

A distinction is made between different network types in the context of the safety assessment. The differences relate to the number of live conductors and earthing points.

The network types are as follows:

- TN networks
- TT networks
- IT networks

T = Terra (Latin for earth)

N = Neutral

I = Isolation

S = Séparé (French for separate)

C = Combiné (French for combined)

The neutral point of the source is earthed directly in the **TN network**.

The bodies of the connected devices are connected to the neutral point of the network via an earth lead.

Note:

Neutral conductor (N)



Earth lead (PE)



PEN conductor (PEN)



TN-Network

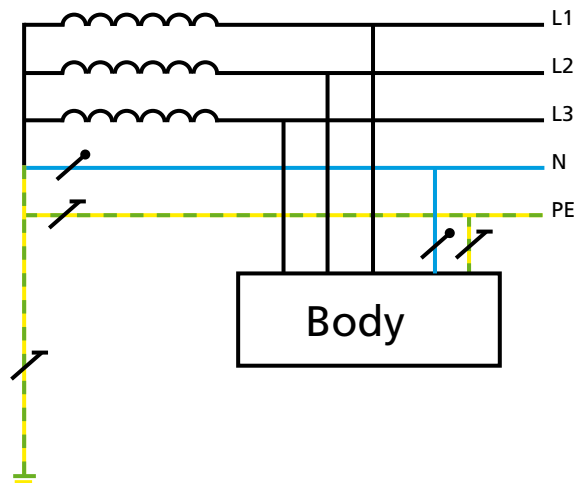

TN-S network: Neutral conductor and earth lead separated

TN-Network

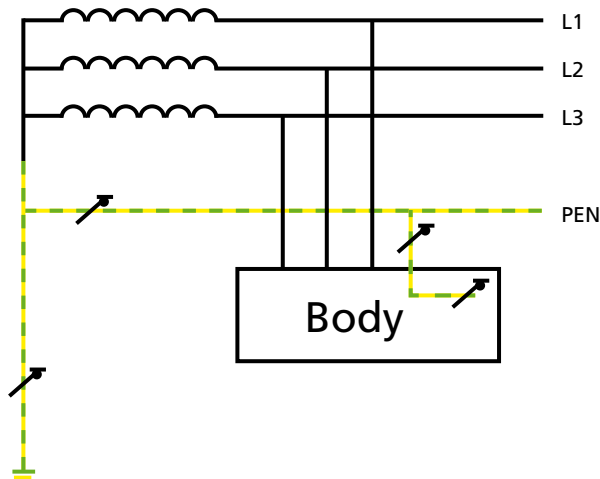

TN-C network: Neutral conductor and earth lead combined in PEN conductor.

TN-Network

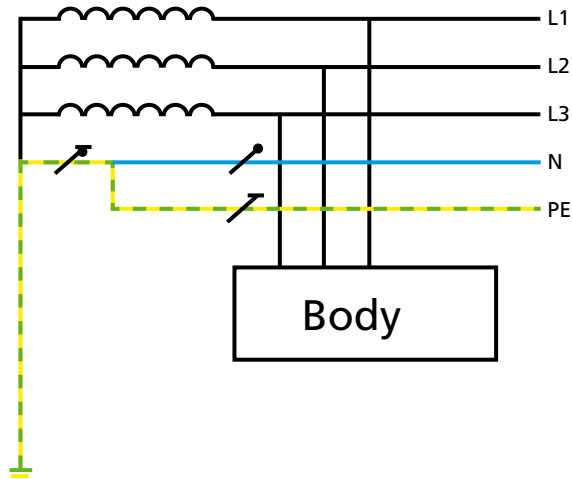

TN-C-S-Network: Neutral conductors and earth leads are combined initially so that they can then be separated. (cross-section reduction)

TT-Network

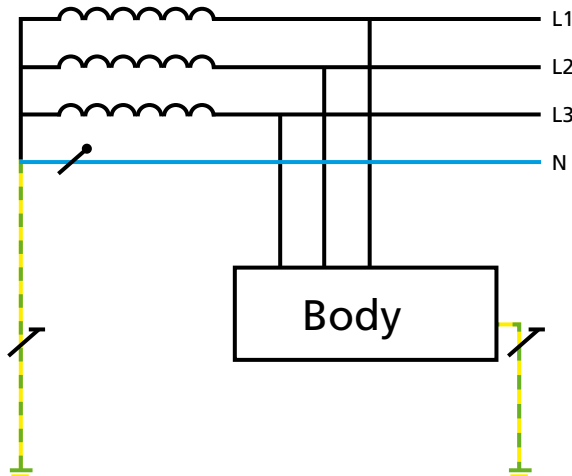

In the **TT network**, the neutral point of the network and the bodies of the connected devices are separately connected directly to earth.

IT-Network

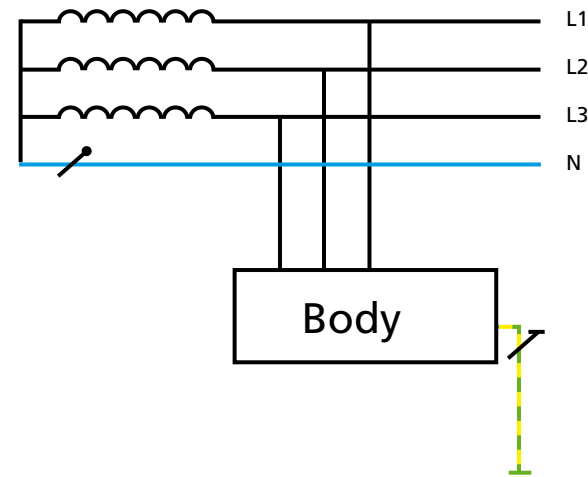

The neutral point of the network is not earthed in the **IT network**.
The bodies of the connected devices are separately connected directly to earth.

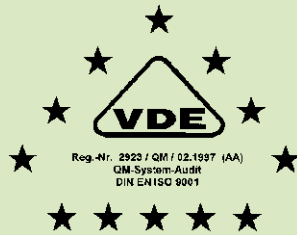

The development, testing and production per national regulations, European standards and special approvals document the high safety standard of els brand products.

Quality management system per DIN EN ISO 9001

„Register number: 2923 / QM 02.97 (AA) from the VDE testing and certification institute“

DIN VDE 0606 part 1

Connection material up to 690 V
Part 1: Installation boxes for mounting devices and/or connecting terminals

DIN VDE 60670

Boxes and enclosures for electrical accessories for household and similar fixed electrical installations

Part 1: General requirements

Part 21: Special requirements for boxes and enclosures with hanging fasteners

Part 22: Special requirements for junction boxes

Part 23: Special requirements for underfloor boxes

DIN EN 60999, VDE 0609 part 1

Connection materials (electrical copper conductors) safety requirements for screw terminal points and screw-less terminal points

Part 1: General requirements and special requirements for clamping points for conductors with a cross-section of 0.2 mm² up to and including 35 mm²

DIN EN 60998 (VDE 0613)

Connection materials for low voltage circuits for households and similar purposes

Part 1: General requirements

Part 2-1: Special requirements for connection materials as independent equipment with screw terminals

Part 2-2: Special requirements for connection materials as independent equipment with screw-less clamping points

DIN EN 60947-7-1 (VDE 0611 part 1)

Low voltage switchgear

Part 7-1: Auxiliary devices – terminal blocks – for copper conductors

DIN VDE 0603

Installation distribution boards and meter plates 400 VAC

Part 1: Installation distribution boards and meter plates

Part 2: Main line branch terminals

DIN EN 62208 (VDE 0660-511)

Empty enclosures for low-voltage switchgear combinations, general requirements

DIN EN 61439 / VDE 0660-600

Low-voltage switchgear combinations

Approval through Bureau Veritas

Certificate no.: 2661 D / 2869 / CO / PRSO BV
File no.: ACE 15 / 241 / 01

Shock-testing at the Bundesamt für Zivilschutz [Federal authority for civil defence]

Regulation class RK 0.63 / 6.3 safety factor A, certificate of use 23 / 95

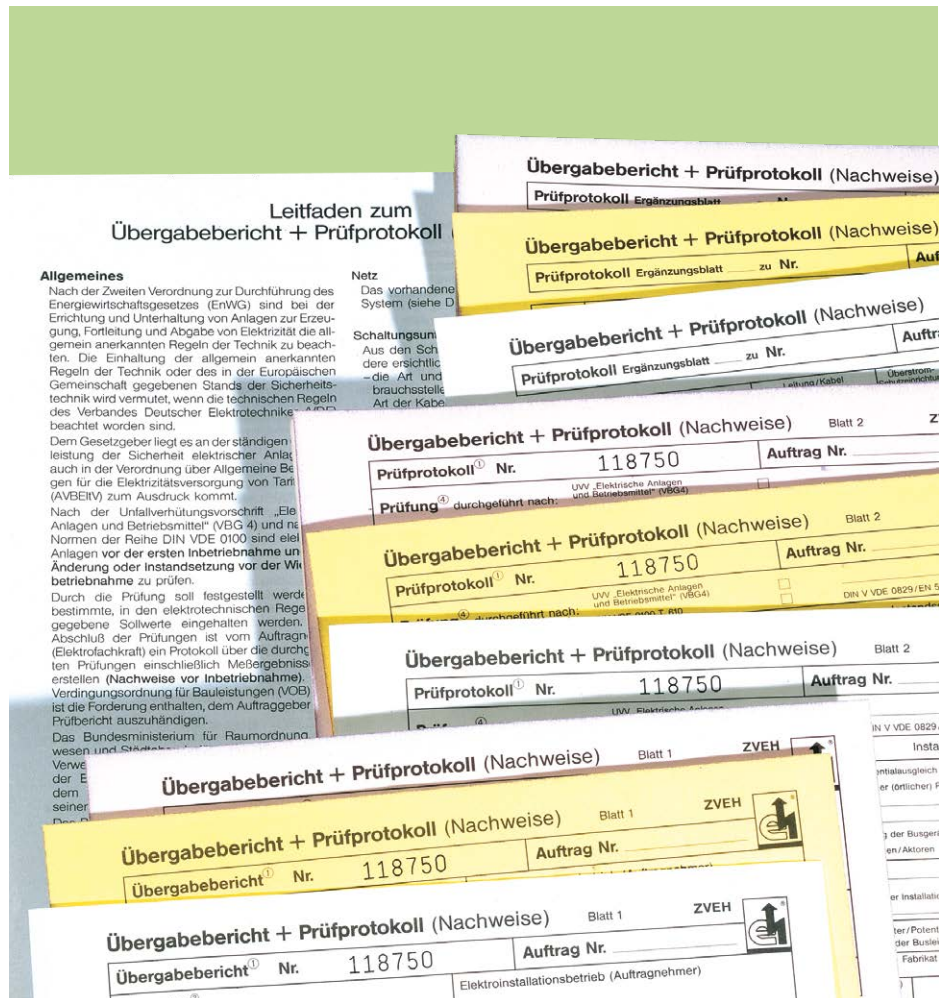

Extract from the determination of inspection intervals from the DGUV regulation 3 (formerly BGV A3):

Electrical systems and stationary equipment:
Inspection interval 4 years

Portable electrical equipment:
Guide value 6 months, 3 months on construction sites

Fault current, differential current and fault voltage circuit breakers:
6 months in stationary systems, every working day in non-stationary systems

Acceptance by the end customer and handover of fully functional system
An acceptance procedure and handover to the end customer is carried out at the conclusion of the commissioning. The order is completed with the issue of the associated final documentation, test logs and handover reports.

It is advisable to generate a handover report and a test log. There is a template from the ZVEH available for this.

Inspection intervals
The operator shall ensure that the electrical system and equipment is checked to ensure that it is in a proper condition:

1. Prior to initial commissioning and after any change or repair work, before the recommissioning by an electrician or under the guidance and supervision of an electrician.
2. At defined intervals.
The intervals are to be set such that defects that would normally be expected to arise are detected in good time.

Order-No.	Description	Disc. Group	Page	Order-No.	Description	Disc. Group	Page
010 401 01	GTi 1-g Empty enclosure	360	36	105 411 01	TK PS 2518-6f-m Empty enclosure	600	192
070 800 01	ZPR Z wall profile	360	165	105 412 01	TK PS 3625-11-m Empty enclosure	600	194
071 013 01	GMI 3 Mounting plate	360	46	105 413 01	TK PS 1818-6f-m Empty enclosure	600	190
072 200 01	GFL 20 Flange	360	36	105 414 01	TK PS 1811-6f-m Empty enclosure	600	186
072 803 01	GFG 3 Flange bar	360	36	105 415 01	TK PS 1813-6f-m Empty enclosure	600	188
073 003 01	GZE 3 Strain relief	360	36	105 416 01	TK PS 1813-9-m Empty enclosure	600	188
073 004 01	GZE 4 Strain relief	360	45	105 901 01	TK PS 77-8-m Empty enclosure	600	178
073 032 01	GKE 32 Cable entry	360	35	105 902 01	TK PS 97-8-m Empty enclosure	600	180
073 043 01	GKE 43 Cable entry	360	35	105 903 01	TK PS 99-8-m Empty enclosure	600	180
076 125 01	AKL 125 Terminal	360	36	105 904 01	TK PS 1111-9-m Empty enclosure	600	182
076 140 01	AKL 140 Terminal	360	45	105 905 01	TK PS 1313-10-m Empty enclosure	600	184
100 403 01	TG ABS 88-6-o Empty enclosure	800	206	105 906 01	TK PS 1811-11-m Empty enclosure	600	186
100 404 01	TG ABS 1208-6-o Empty enclosure	800	208	105 907 01	TK PS 1818-11-m Empty enclosure	600	190
100 405 01	TG ABS 1212-6-o Empty enclosure	800	210	105 908 01	TK PS 2518-11-m Empty enclosure	600	192
100 406 01	TG ABS 1608-6-o Empty enclosure	800	212	105 909 01	TK PS 1309-8-m Empty enclosure	600	184
100 407 01	TG ABS 1612-9-o Empty enclosure	800	214	105 910 01	TK PS 1809-8-m Empty enclosure	600	184
100 408 01	TG ABS 2012-8-o Empty enclosure	800	214	105 911 01	TK PS 2518-8f-m Empty enclosure	600	192
100 409 01	TG ABS 2015-9-o Empty enclosure	800	216	105 912 01	TK PS 3625-16-m Empty enclosure	600	194
100 412 01	TG ABS 2516-9-o Empty enclosure	800	218	105 913 01	TK PS 1818-8f-m Empty enclosure	600	190
100 413 01	TG ABS 3023-9-o Empty enclosure	800	220	105 914 01	TK PS 1811-8f-m Empty enclosure	600	186
100 903 01	TG ABS 88-9-o Empty enclosure	800	206	105 915 01	TK PS 1813-8f-m Empty enclosure	600	188
100 904 01	TG ABS 1208-9-o Empty enclosure	800	208	105 916 01	TK PS 1813-11-m Empty enclosure	600	188
100 905 01	TG ABS 1212-9-o Empty enclosure	800	210	106 001 01	TK PS 77-6-tm Empty enclosure	600	178
100 906 01	TG ABS 1608-9-o Empty enclosure	800	212	106 002 01	TK PS 97-6-tm Empty enclosure	600	180
100 908 01	TG ABS 2012-9-o Empty enclosure	800	216	106 003 01	TK PS 99-6-tm Empty enclosure	600	180
100 912 01	TG ABS 2516-12-o Empty enclosure	800	218	106 004 01	TK PS 1111-7-tm Empty enclosure	600	182
100 913 01	TG ABS 3023-11-o Empty enclosure	800	220	106 005 01	TK PS 1313-7-tm Empty enclosure	600	184
101 003 01	TG ABS 88-6-to Empty enclosure	800	206	106 006 01	TK PS 1811-9-tm Empty enclosure	600	186
101 004 01	TG ABS 1208-6-to Empty enclosure	800	208	106 007 01	TK PS 1818-9-tm Empty enclosure	600	190
101 005 01	TG ABS 1212-6-to Empty enclosure	800	210	106 008 01	TK PS 2518-9-tm Empty enclosure	600	192
101 006 01	TG ABS 1608-6-to Empty enclosure	800	212	106 009 01	TK PS 1309-6-tm Empty enclosure	600	184
101 007 01	TG ABS 1612-9-to Empty enclosure	800	214	106 010 01	TK PS 1809-6-tm Empty enclosure	600	184
101 008 01	TG ABS 2012-8-to Empty enclosure	800	214	106 011 01	TK PS 2518-6f-tm Empty enclosure	600	192
101 009 01	TG ABS 2015-9-to Empty enclosure	800	216	106 012 01	TK PS 3625-11-tm Empty enclosure	600	194
101 012 01	TG ABS 2516-9-to Empty enclosure	800	218	106 013 01	TK PS 1818-6f-tm Empty enclosure	600	190
101 013 01	TG ABS 3023-9-to Empty enclosure	800	220	106 014 01	TK PS 1811-6f-tm Empty enclosure	600	186
101 503 01	TG ABS 88-9-to Empty enclosure	800	206	106 015 01	TK PS 1813-6f-tm Empty enclosure	600	188
101 504 01	TG ABS 1208-9-to Empty enclosure	800	208	106 016 01	TK PS 1813-9-tm Empty enclosure	600	188
101 505 01	TG ABS 1212-9-to Empty enclosure	800	210	106 501 01	TK PS 77-8-tm Empty enclosure	600	178
101 506 01	TG ABS 1608-9-to Empty enclosure	800	212	106 502 01	TK PS 97-8-tm Empty enclosure	600	180
101 508 01	TG ABS 2012-9-to Empty enclosure	800	216	106 503 01	TK PS 99-8-tm Empty enclosure	600	180
101 512 01	TG ABS 2516-12-to Empty enclosure	800	218	106 504 01	TK PS 1111-9-tm Empty enclosure	600	182
101 513 01	TG ABS 3023-11-to Empty enclosure	800	220	106 505 01	TK PS 1313-10-tm Empty enclosure	600	184
104 406 01	TK PS 1811-16-m Empty enclosure	600	186	106 506 01	TK PS 1811-11-tm Empty enclosure	600	186
104 407 01	TK PS 1818-16-m Empty enclosure	600	190	106 507 01	TK PS 1818-11-tm Empty enclosure	600	190
104 408 01	TK PS 2518-16-m Empty enclosure	600	192	106 508 01	TK PS 2518-11-tm Empty enclosure	600	192
104 411 01	TK PS 2518-13f-m Empty enclosure	600	192	106 509 01	TK PS 1309-8-tm Empty enclosure	600	184
104 413 01	TK PS 1818-13f-m Empty enclosure	600	190	106 510 01	TK PS 1809-8-tm Empty enclosure	600	184
104 414 01	TK PS 1811-13f-m Empty enclosure	600	186	106 511 01	TK PS 2518-8f-tm Empty enclosure	600	192
104 415 01	TK PS 1813-13f-m Empty enclosure	600	188	106 512 01	TK PS 3625-16-tm Empty enclosure	600	194
104 416 01	TK PS 1813-16-m Empty enclosure	600	188	106 513 01	TK PS 1818-8f-tm Empty enclosure	600	190
105 401 01	TK PS 77-6-m Empty enclosure	600	178	106 514 01	TK PS 1811-8f-tm Empty enclosure	600	186
105 402 01	TK PS 97-6-m Empty enclosure	600	180	106 515 01	TK PS 1813-8f-tm Empty enclosure	600	188
105 403 01	TK PS 99-6-m Empty enclosure	600	180	106 516 01	TK PS 1813-11-tm Empty enclosure	600	188
105 404 01	TK PS 1111-7-m Empty enclosure	600	182	107 006 01	TK PS 1811-16-tm Empty enclosure	600	186
105 405 01	TK PS 1313-7-m Empty enclosure	600	184	107 007 01	TK PS 1818-16-tm Empty enclosure	600	190
105 406 01	TK PS 1811-9-m Empty enclosure	600	186	107 008 01	TK PS 2518-16-tm Empty enclosure	600	192
105 407 01	TK PS 1818-9-m Empty enclosure	600	190	107 011 01	TK PS 2518-13f-tm Empty enclosure	600	192
105 408 01	TK PS 2518-9-m Empty enclosure	600	192	107 013 01	TK PS 1818-13f-tm Empty enclosure	600	190
105 409 01	TK PS 1309-6-m Empty enclosure	600	184	107 014 01	TK PS 1811-13f-tm Empty enclosure	600	186
105 410 01	TK PS 1809-6-m Empty enclosure	600	184	107 015 01	TK PS 1813-13f-tm Empty enclosure	600	188

Order-No.	Description	Disc. Group	Page	Order-No.	Description	Disc. Group	Page
107 016 01	TK PS 1813-16-tm Empty enclosure	600	188	111 505 01	TK PS 1313-10-to Empty enclosure	600	184
109 406 01	TK PS 1811-16-o Empty enclosure	600	186	111 506 01	TK PS 1811-11-to Empty enclosure	600	186
109 407 01	TK PS 1818-16-o Empty enclosure	600	190	111 507 01	TK PS 1818-11-to Empty enclosure	600	190
109 408 01	TK PS 2518-16-o Empty enclosure	600	192	111 508 01	TK PS 2518-11-to Empty enclosure	600	192
109 411 01	TK PS 2518-13f-o Empty enclosure	600	192	111 509 01	TK PS 1309-8-to Empty enclosure	600	184
109 413 01	TK PS 1818-13f-o Empty enclosure	600	190	111 510 01	TK PS 1809-8-to Empty enclosure	600	184
109 414 01	TK PS 1811-13f-o Empty enclosure	600	186	111 511 01	TK PS 2518-8f-to Empty enclosure	600	192
109 415 01	TK PS 1813-13f-o Empty enclosure	600	188	111 512 01	TK PS 3625-16-to Empty enclosure	600	194
109 416 01	TK PS 1813-16-o Empty enclosure	600	188	111 513 01	TK PS 1818-8f-to Empty enclosure	600	190
110 401 01	TK PS 77-6-o Empty enclosure	600	178	111 514 01	TK PS 1811-8f-to Empty enclosure	600	186
110 402 01	TK PS 97-6-o Empty enclosure	600	180	111 515 01	TK PS 1813-8f-to Empty enclosure	600	188
110 403 01	TK PS 99-6-o Empty enclosure	600	180	111 516 01	TK PS 1813-11-to Empty enclosure	600	188
110 404 01	TK PS 1111-7-o Empty enclosure	600	182	112 006 01	TK PS 1811-16-to Empty enclosure	600	186
110 405 01	TK PS 1313-7-o Empty enclosure	600	184	112 007 01	TK PS 1818-16-to Empty enclosure	600	190
110 406 01	TK PS 1811-9-o Empty enclosure	600	186	112 008 01	TK PS 2518-16-to Empty enclosure	600	192
110 407 01	TK PS 1818-9-o Empty enclosure	600	190	112 011 01	TK PS 2518-13f-to Empty enclosure	600	192
110 408 01	TK PS 2518-9-o Empty enclosure	600	192	112 013 01	TK PS 1818-13f-to Empty enclosure	600	190
110 409 01	TK PS 1309-6-o Empty enclosure	600	184	112 014 01	TK PS 1811-13f-to Empty enclosure	600	186
110 410 01	TK PS 1809-6-o Empty enclosure	600	184	112 015 01	TK PS 1813-13f-to Empty enclosure	600	188
110 411 01	TK PS 2518-6f-o Empty enclosure	600	192	112 016 01	TK PS 1813-16-to Empty enclosure	600	188
110 412 01	TK PS 3625-11-o Empty enclosure	600	194	120 455 01	TK PC 55-4-o Empty enclosure	600	178
110 413 01	TK PS 1818-6f-o Empty enclosure	600	190	120 475 01	TK PC 75-4-o Empty enclosure	600	178
110 414 01	TK PS 1811-6f-o Empty enclosure	600	186	120 480 01	TK PC 1005-4-o Empty enclosure	600	182
110 415 01	TK PS 1813-6f-o Empty enclosure	600	188	127 401 01	TK PC 77-6-m Empty enclosure	600	178
110 416 01	TK PS 1813-9-o Empty enclosure	600	188	127 402 01	TK PC 97-6-m Empty enclosure	600	180
110 901 01	TK PS 77-8-o Empty enclosure	600	178	127 403 01	TK PC 99-6-m Empty enclosure	600	180
110 902 01	TK PS 97-8-o Empty enclosure	600	180	127 404 01	TK PC 1111-7-m Empty enclosure	600	182
110 903 01	TK PS 99-8-o Empty enclosure	600	180	127 405 01	TK PC 1313-7-m Empty enclosure	600	184
110 904 01	TK PS 1111-9-o Empty enclosure	600	182	127 406 01	TK PC 1811-9-m Empty enclosure	600	186
110 905 01	TK PS 1313-10-o Empty enclosure	600	184	127 407 01	TK PC 1818-9-m Empty enclosure	600	190
110 906 01	TK PS 1811-11-o Empty enclosure	600	186	127 408 01	TK PC 2518-9-m Empty enclosure	600	192
110 907 01	TK PS 1818-11-o Empty enclosure	600	190	127 409 01	TK PC 1309-6-m Empty enclosure	600	184
110 908 01	TK PS 2518-11-o Empty enclosure	600	192	127 410 01	TK PC 1809-6-m Empty enclosure	600	184
110 909 01	TK PS 1309-8-o Empty enclosure	600	184	127 411 01	TK PC 2518-6f-m Empty enclosure	600	192
110 910 01	TK PS 1809-8-o Empty enclosure	600	184	127 412 01	TK PC 3625-11-m Empty enclosure	600	194
110 911 01	TK PS 2518-8f-o Empty enclosure	600	192	127 413 01	TK PC 1818-6f-m Empty enclosure	600	190
110 912 01	TK PS 3625-16-o Empty enclosure	600	194	127 414 01	TK PC 1811-6f-m Empty enclosure	600	186
110 913 01	TK PS 1818-8f-o Empty enclosure	600	190	127 415 01	TK PC 1813-6f-m Empty enclosure	600	188
110 914 01	TK PS 1811-8f-o Empty enclosure	600	186	127 416 01	TK PC 1813-9-m Empty enclosure	600	188
110 915 01	TK PS 1813-8f-o Empty enclosure	600	188	127 455 01	TK PC 55-4-m Empty enclosure	600	178
110 916 01	TK PS 1813-11-o Empty enclosure	600	188	127 475 01	TK PC 75-4-m Empty enclosure	600	178
111 001 01	TK PS 77-6-to Empty enclosure	600	178	127 480 01	TK PC 1005-4-m Empty enclosure	600	182
111 002 01	TK PS 97-6-to Empty enclosure	600	180	127 901 01	TK PC 77-8-m Empty enclosure	600	178
111 003 01	TK PS 99-6-to Empty enclosure	600	180	127 902 01	TK PC 97-8-m Empty enclosure	600	180
111 004 01	TK PS 1111-7-to Empty enclosure	600	182	127 903 01	TK PC 99-8-m Empty enclosure	600	180
111 005 01	TK PS 1313-7-to Empty enclosure	600	184	127 904 01	TK PC 1111-9-m Empty enclosure	600	182
111 006 01	TK PS 1811-9-to Empty enclosure	600	186	127 905 01	TK PC 1313-10-m Empty enclosure	600	184
111 007 01	TK PS 1818-9-to Empty enclosure	600	190	127 906 01	TK PC 1811-11-m Empty enclosure	600	186
111 008 01	TK PS 2518-9-to Empty enclosure	600	192	127 907 01	TK PC 1818-11-m Empty enclosure	600	190
111 009 01	TK PS 1309-6-to Empty enclosure	600	184	127 908 01	TK PC 2518-11-m Empty enclosure	600	192
111 010 01	TK PS 1809-6-to Empty enclosure	600	184	127 909 01	TK PC 1309-8-m Empty enclosure	600	184
111 011 01	TK PS 2518-6f-to Empty enclosure	600	192	127 910 01	TK PC 1809-8-m Empty enclosure	600	184
111 012 01	TK PS 3625-11-to Empty enclosure	600	194	127 911 01	TK PC 2518-8f-m Empty enclosure	600	192
111 013 01	TK PS 1818-6f-to Empty enclosure	600	190	127 912 01	TK PC 3625-16-m Empty enclosure	600	194
111 014 01	TK PS 1811-6f-to Empty enclosure	600	186	127 913 01	TK PC 1818-8f-m Empty enclosure	600	190
111 015 01	TK PS 1813-6f-to Empty enclosure	600	188	127 914 01	TK PC 1811-8f-m Empty enclosure	600	186
111 016 01	TK PS 1813-9-to Empty enclosure	600	188	127 915 01	TK PC 1813-8f-m Empty enclosure	600	188
111 501 01	TK PS 77-8-to Empty enclosure	600	178	127 916 01	TK PC 1813-11-m Empty enclosure	600	188
111 502 01	TK PS 97-8-to Empty enclosure	600	180	128 406 01	TK PC 1811-16-m Empty enclosure	600	186
111 503 01	TK PS 99-8-to Empty enclosure	600	180	128 407 01	TK PC 1818-16-m Empty enclosure	600	190
111 504 01	TK PS 1111-9-to Empty enclosure	600	182	128 408 01	TK PC 2518-16-m Empty enclosure	600	192

Order-No.	Description	Disc. Group	Page	Order-No.	Description	Disc. Group	Page
128 411 01	TK PC 2518-13f-m Empty enclosure	600	192	151 006 01	TK AL 1811-9 Empty enclosure	700	197
128 413 01	TK PC 1818-13f-m Empty enclosure	600	190	151 007 01	TK AL 1818-9 Empty enclosure	700	197
128 414 01	TK PC 1811-13f-m Empty enclosure	600	186	151 008 01	TK AL 2518-9 Empty enclosure	700	197
128 415 01	TK PC 1813-13f-m Empty enclosure	600	188	151 012 01	TK AL 3625-11 Empty enclosure	700	197
128 416 01	TK PC 1813-16-m Empty enclosure	600	188	154 004 01	AL ALS-kl External attachment set	700	201
128 475 01	TK PC 75-4-2v Empty enclosure	600	178	154 006 01	AL ALS-gro External attachment set	700	201
129 455 01	TK PC 55-4-v Empty enclosure	600	178	154 210 01	AL ASS External hinge set	700	201
129 475 01	TK PC 75-4-v Empty enclosure	600	178	155 005 01	AL MPS-88 Mounting plate	700	236
130 455 01	TK PC 55-4-to Empty enclosure	600	178	155 006 01	AL MPS-1308 Mounting plate	700	236
130 475 01	TK PC 75-4-to Empty enclosure	600	178	155 007 01	AL MPS-1808 Mounting plate	700	236
130 480 01	TK PC 1005-4-to Empty enclosure	600	182	155 008 01	AL MPS-1010 Mounting plate	700	236
137 001 01	TK PC 77-6-tm Empty enclosure	600	178	155 009 01	AL MPS-1212 Mounting plate	700	236
137 002 01	TK PC 97-6-tm Empty enclosure	600	180	155 010 01	AL MPS-2212 Mounting plate	700	236
137 003 01	TK PC 99-6-tm Empty enclosure	600	180	155 011 01	AL MPS-1616 Mounting plate	700	236
137 004 01	TK PC 1111-7-tm Empty enclosure	600	182	155 012 01	AL MPS-2616 Mounting plate	700	236
137 005 01	TK PC 1313-7-tm Empty enclosure	600	184	155 013 01	AL MPS-3616 Mounting plate	700	236
137 006 01	TK PC 1811-9-tm Empty enclosure	600	186	155 014 01	AL MPS-2320 Mounting plate	700	236
137 007 01	TK PC 1818-9-tm Empty enclosure	600	190	155 015 01	AL MPS-2823 Mounting plate	700	236
137 008 01	TK PC 2518-9-tm Empty enclosure	600	192	155 016 01	AL MPS-3323 Mounting plate	700	236
137 009 01	TK PC 1309-6-tm Empty enclosure	600	184	160 405 01	ALR 88-4 ² Terminal block housing	700	136
137 010 01	TK PC 1809-6-tm Empty enclosure	600	184	160 406 01	ALR 1308-4 ² Terminal block housing	700	136
137 011 01	TK PC 2518-6f-tm Empty enclosure	600	192	160 407 01	ALR 1808-4 ² Terminal block housing	700	136
137 012 01	TK PC 3625-11-tm Empty enclosure	600	194	160 408 01	ALR 1010-4 ² Terminal block housing	700	136
137 013 01	TK PC 1818-6f-tm Empty enclosure	600	190	160 409 01	ALR 1212-4 ² Terminal block housing	700	137
137 014 01	TK PC 1811-6f-tm Empty enclosure	600	186	160 410 01	ALR 2212-4 ² Terminal block housing	700	137
137 015 01	TK PC 1813-6f-tm Empty enclosure	600	188	160 411 01	ALR 1616-4 ² Terminal block housing	700	137
137 016 01	TK PC 1813-9-tm Empty enclosure	600	188	160 412 01	ALR 2616-4 ² Terminal block housing	700	137
137 455 01	TK PC 55-4-tm Empty enclosure	600	178	160 413 01	ALR 3616-4 ² Terminal block housing	700	138
137 475 01	TK PC 75-4-tm Empty enclosure	600	178	160 414 01	ALR 2320-4 ² Terminal block housing	700	138
137 480 01	TK PC 1005-4-tm Empty enclosure	600	182	160 415 01	ALR 2823-4 ² Terminal block housing	700	138
137 501 01	TK PC 77-8-tm Empty enclosure	600	178	160 416 01	ALR 3323-4 ² Terminal block housing	700	138
137 502 01	TK PC 97-8-tm Empty enclosure	600	180	160 909 01	ALR 1212-L Terminal block housing	700	137
137 503 01	TK PC 99-8-tm Empty enclosure	600	180	160 910 01	ALR 2212-L Terminal block housing	700	137
137 504 01	TK PC 1111-9-tm Empty enclosure	600	182	160 911 01	ALR 1616-L Terminal block housing	700	137
137 505 01	TK PC 1313-10-tm Empty enclosure	600	184	160 912 01	ALR 2616-L Terminal block housing	700	137
137 506 01	TK PC 1811-11-tm Empty enclosure	600	186	160 913 01	ALR 3616-L Terminal block housing	700	138
137 507 01	TK PC 1818-11-tm Empty enclosure	600	190	160 914 01	ALR 2320-L Terminal block housing	700	138
137 508 01	TK PC 2518-11-tm Empty enclosure	600	192	160 915 01	ALR 2823-L Terminal block housing	700	138
137 509 01	TK PC 1309-8-tm Empty enclosure	600	184	160 916 01	ALR 3323-L Terminal block housing	700	138
137 510 01	TK PC 1809-8-tm Empty enclosure	600	184	162 009 01	AL NS35-110 Standard rail	700	236
137 511 01	TK PC 2518-8f-tm Empty enclosure	600	192	162 010 01	AL NS35-208 Standard rail	700	236
137 512 01	TK PC 3625-16-tm Empty enclosure	600	194	162 011 01	AL NS35-145 Standard rail	700	236
137 513 01	TK PC 1818-8f-tm Empty enclosure	600	190	162 012 01	AL NS35-245 Standard rail	700	236
137 514 01	TK PC 1811-8f-tm Empty enclosure	600	186	162 013 01	AL NS35-345 Standard rail	700	236
137 515 01	TK PC 1813-8f-tm Empty enclosure	600	188	162 014 01	AL NS35-186 Standard rail	700	236
137 516 01	TK PC 1813-11-tm Empty enclosure	600	188	162 015 01	AL NS35-266 Standard rail	700	236
138 006 01	TK PC 1811-16-tm Empty enclosure	600	186	162 016 01	AL NS35-316 Standard rail	700	236
138 007 01	TK PC 1818-16-tm Empty enclosure	600	190	182 001 01	TG ISS Interior hinge set	800	223
138 008 01	TK PC 2518-16-tm Empty enclosure	600	192	182 002 01	TG ABL External fixing lugs kit	800	223
138 011 01	TK PC 2518-13f-tm Empty enclosure	600	192	182 004 01	TG PST1 Sealing kit	800	223
138 013 01	TK PC 1818-13f-tm Empty enclosure	600	190	182 005 01	TG PST2 Sealing kit	800	223
138 014 01	TK PC 1811-13f-tm Empty enclosure	600	186	182 006 01	TG DVS-42 Cover retainer	800	223
138 015 01	TK PC 1813-13f-tm Empty enclosure	600	188	182 007 01	TG DVS-57 Cover retainer	800	223
138 016 01	TK PC 1813-16-tm Empty enclosure	600	188	186 003 01	TG MPI-88 Mounting plate	800	222
138 475 01	TK PC 75-4-2tv Empty enclosure	600	178	186 004 01	TG MPI-1208 Mounting plate	800	222
139 455 01	TK PC 55-4-tv Empty enclosure	600	178	186 005 01	TG MPI-1212 Mounting plate	800	222
139 475 01	TK PC 75-4-tv Empty enclosure	600	178	186 006 01	TG MPI-1608 Mounting plate	800	222
151 001 01	TK AL 77-6 Empty enclosure	700	196	186 007 01	TG MPI-1612 Mounting plate	800	222
151 003 01	TK AL 99-6 Empty enclosure	700	196	186 008 01	TG MPI-2012 Mounting plate	800	222
151 004 01	TK AL 1111-7 Empty enclosure	700	196	186 009 01	TG MPI-2015 Mounting plate	800	222
151 005 01	TK AL 1313-7 Empty enclosure	700	196	186 012 01	TG MPI-2516 Mounting plate	800	222

 = NEW product

Index of order numbers

Order-No.	Description	Disc. Group	Page	Order-No.	Description	Disc. Group	Page
186 013 01	TG MPI-3023 Mounting plate	800	222	197 006 01	TK MPS-1811 Mounting plate	600	198
187 003 01	TG MPS-88 Mounting plate	800	222	197 007 01	TK MPS-1818 Mounting plate	600	198
187 004 01	TG MPS-1208 Mounting plate	800	222	197 008 01	TK MPS-2518 Mounting plate	600	198
187 005 01	TG MPS-1212 Mounting plate	800	222	197 009 01	TK MPS-1309 Mounting plate	600	198
187 006 01	TG MPS-1608 Mounting plate	800	222	197 010 01	TK MPS-1809 Mounting plate	600	198
187 007 01	TG MPS-1612 Mounting plate	800	222	197 011 01	TK MPS-1813 Mounting plate	600	198
187 008 01	TG MPS-2012 Mounting plate	800	222	197 012 01	TK MPS-3625 Mounting plate	600	198
187 009 01	TG MPS-2015 Mounting plate	800	222	197 049 01	TS 15-49,5 Standard rail	600	199
187 012 01	TG MPS-2516 Mounting plate	800	222	197 069 01	TS 15-66 Standard rail	600	222
187 013 01	TG MPS-3023 Mounting plate	800	222	197 080 01	TS 15-80 Standard rail	600	199
190 001 01	HBA Mounting material	600	200	197 092 01	TS 15-92 Standard rail	600	199
190 002 01	ASS-kl External hinge set	600	200	197 107 01	TS 15-104 Standard rail	600	222
190 005 01	ASS-gro External hinge set	600	200	197 110 01	TS 15-108 Standard rail	600	222
190 010 01	TK DS-ku/g Lid screw	600	202	197 111 01	TS 15-111 Standard rail	600	199
190 011 01	TK DS-ig/g Lid screw	600	202	197 146 01	TS 15-144 Standard rail	600	222
190 012 01	TK DS-ku/sw Lid screw	600	202	197 154 01	TS 15-154 Standard rail	600	199
190 013 01	TK DS-ig/sw Lid screw	600	202	197 170 01	TS 15-168 Standard rail	600	222
190 014 01	TK DS-ku/g/T40 Lid screw	600	202	197 186 01	TS 15-184 Standard rail	600	222
190 015 01	TK DS-ku/sw/T40 Lid screw	600	202	197 222 01	TS 15-220 Standard rail	600	222
190 016 01	TK DS-ig/g/T40 Lid screw	600	202	197 285 01	TS 15-283,5 Standard rail	600	222
190 017 01	TK DS-ig/sw/T40 Cover screw	600	202	198 068 01	NS 35-66 Standard rail	600	222
190 100 01	VSG Padlock kit	600	200	198 081 01	NS 35-81 Standard rail	600	46
190 200 01	TK ES-55/75/1005 Installation screw	600	202	198 106 01	NS 35-106 Standard rail	600	46
191 800 01	TG 1 Handle	600	171	198 107 01	NS 35-104 Standard rail	600	222
191 805 01	TG 2 Handle	600	171	198 110 01	NS 35-108 Standard rail	600	222
192 018 01	TK KS GRO Combi set	600	201	198 144 01	NS 35-144 Standard rail	600	199
192 020 01	KS M20 Combi set	600	162	198 146 01	NS 35-144/2 Standard rail	600	222
192 025 01	KS M25 Combi set	600	162	198 170 01	NS 35-168 Standard rail	600	222
192 026 01	KS M25-gro Combi set	600	162	198 186 01	NS 35-184 Standard rail	600	222
192 032 01	KS M32 Combi set	600	162	198 216 01	NS 35-216 Standard rail	600	199
193 025 01	KST M25-17 Combi connector	320	231	198 222 01	NS 35-220 Standard rail	600	222
193 026 01	KST M25-33 Combi connector	320	231	198 285 01	NS 35-283,5 Standard rail	600	222
193 032 01	KST M32 Combi set	320	162	198 336 01	NS 35-336 Standard rail	600	199
194 001 01	TK ABL External fixing lugs kit	600	200	200 403 01	TG PC 88-6-o Empty enclosure	800	206
194 002 01	TK ABP-55/75 External fixing plate	600	199	200 404 01	TG PC 1208-6-o Empty enclosure	800	208
194 100 01	TK DST Spacing kit	600	199	200 405 01	TG PC 1212-6-o Empty enclosure	800	210
194 101 01	MPS-KRI Mounting plate	600	46	200 406 01	TG PC 1608-6-o Empty enclosure	800	212
194 110 01	TK MLH-55/75 Mounting / PCB holder	600	199	200 407 01	TG PC 1612-9-o Empty enclosure	800	214
195 001 01	TK MPI-77 Mounting plate	600	198	200 408 01	TG PC 2012-8-o Empty enclosure	800	214
195 002 01	TK MPI-97 Mounting plate	600	198	200 409 01	TG PC 2015-9-o Empty enclosure	800	216
195 003 01	TK MPI-99 Mounting plate	600	198	200 412 01	TG PC 2516-9-o Empty enclosure	800	218
195 004 01	TK MPI-1111 Mounting plate	600	198	200 413 01	TG PC 3023-9-o Empty enclosure	800	220
195 005 01	TK MPI-1313 Mounting plate	600	198	200 903 01	TG PC 88-9-o Empty enclosure	800	206
195 006 01	TK MPI-1811 Mounting plate	600	198	200 904 01	TG PC 1208-9-o Empty enclosure	800	208
195 007 01	TK MPI-1818 Mounting plate	600	198	200 905 01	TG PC 1212-9-o Empty enclosure	800	210
195 008 01	TK MPI-2518 Mounting plate	600	198	200 906 01	TG PC 1608-9-o Empty enclosure	800	212
195 009 01	TK MPI-1309 Mounting plate	600	198	200 908 01	TG PC 2012-9-o Empty enclosure	800	216
195 010 01	TK MPI-1809 Mounting plate	600	198	200 912 01	TG PC 2516-12-o Empty enclosure	800	218
195 011 01	TK MPI-1813 Mounting plate	600	198	200 913 01	TG PC 3023-11-o Empty enclosure	800	220
195 012 01	TK MPI-3625 Mounting plate	600	198	201 003 01	TG PC 88-6-to Empty enclosure	800	206
195 018 01	TK SDR T40 Screwdriver	600	202	201 004 01	TG PC 1208-6-to Empty enclosure	800	208
195 055 01	TK MPI-55 Mounting plate	600	198	201 005 01	TG PC 1212-6-to Empty enclosure	800	210
195 075 01	TK MPI-75 Mounting plate	600	198	201 006 01	TG PC 1608-6-to Empty enclosure	800	212
195 995 01	LFR Stepped drill	600	202	201 007 01	TG PC 1612-9-to Empty enclosure	800	214
196 009 01	TK TW-n Partition wall	600	200	201 008 01	TG PC 2012-8-to Empty enclosure	800	214
196 909 01	TK TW-h Partition wall	600	200	201 009 01	TG PC 2015-9-to Empty enclosure	800	216
197 001 01	TK MPS-77 Mounting plate	600	198	201 012 01	TG PC 2516-9-to Empty enclosure	800	218
197 002 01	TK MPS-97 Mounting plate	600	198	201 013 01	TG PC 3023-9-to Empty enclosure	800	220
197 003 01	TK MPS-99 Mounting plate	600	198	201 503 01	TG PC 88-9-to Empty enclosure	800	206
197 004 01	TK MPS-1111 Mounting plate	600	198	201 504 01	TG PC 1208-9-to Empty enclosure	800	208
197 005 01	TK MPS-1313 Mounting plate	600	198	201 505 01	TG PC 1212-9-to Empty enclosure	800	210

Order-No.	Description	Disc. Group	Page	Order-No.	Description	Disc. Group	Page
201 506 01	TG PC 1608-9-to Empty enclosure	800	212	230 620 01	AST M20-or Attachment bushes	400	83
201 508 01	TG PC 2012-9-to Empty enclosure	800	216	230 625 01	AST M25-or Attachment bushes	400	83
201 512 01	TG PC 2516-12-to Empty enclosure	800	218	230 632 01	AST M32-or Attachment bushes	400	83
201 513 01	TG PC 3023-11-to Empty enclosure	800	220	230 640 01	AST M40-or Attachment bushes	400	83
203 016 01	WST M16/sw Twist plug	400	292	231 416 01	VST M16 Sealing plugs	400	292
203 020 01	WST M20/sw Twist plug	400	292	231 420 01	VST M20 Sealing plugs	400	292
203 025 01	WST M25/sw Twist plug	400	292	231 425 01	VST M25 Sealing plugs	400	292
203 416 01	WST M16 Twist plug	400	292	231 432 01	VST M32 Sealing plugs	400	292
203 420 01	WST M20 Twist plug	400	292	231 440 01	VST M40 Sealing plugs	400	292
203 425 01	WST M25 Twist plug	400	292	231 620 01	VST M20-or Sealing plugs	400	83
203 432 01	WST M32 Twist plug	400	292	231 625 01	VST M25-or Sealing plugs	400	83
203 440 01	WST M40 Twist plug	400	292	231 632 01	VST M32-or Sealing plugs	400	83
203 450 01	WST M50 Twist plug	400	292	231 640 01	VST M40-or Sealing plugs	400	83
203 463 01	WST M63 Twist plug	400	292	247 412 01	KVR M12 Cable gland	400	295
208 412 01	GMU PA M12 Lock nut	400	296	247 416 01	KVR M16 Cable gland	400	295
208 416 01	GMU PA M16 Lock nut	400	296	247 420 01	KVR M20 Cable gland	400	295
208 420 01	GMU PA M20 Lock nut	400	296	247 421 01	KVR M20-GDB Cable gland	400	295
208 425 01	GMU PA M25 Lock nut	400	296	247 425 01	KVR M25 Cable gland	400	295
208 432 01	GMU PA M32 Lock nut	400	296	247 432 01	KVR M32 Cable gland	400	295
208 440 01	GMU PA M40 Lock nut	400	296	247 440 01	KVR M40 Cable gland	400	295
208 450 01	GMU PA M50 Lock nut	400	296	247 450 01	KVR M50 Cable gland	400	295
208 463 01	GMU PA M63 Lock nut	400	296	247 463 01	KVR M63 Cable gland	400	295
211 116 01	VSS PA M16 Blanking plug	400	293	249 012 01	ADR M12 Sealing ring	400	296
211 120 01	VSS PA M20 Blanking plug	400	293	249 016 01	ADR M16 Sealing ring	400	296
211 125 01	VSS PA M25 Blanking plug	400	293	249 020 01	ADR M20 Sealing ring	400	296
211 132 01	VSS PA M32 Blanking plug	400	293	249 025 01	ADR M25 Sealing ring	400	296
213 016 01	WNI M16/sw Twist nipple	400	292	249 032 01	ADR M32 Sealing ring	400	296
213 020 01	WNI M20/sw Twist nipple	400	292	249 040 01	ADR M40 Sealing ring	400	296
213 025 01	WNI M25/sw Twist nipple	400	292	249 050 01	ADR M50 Sealing ring	400	296
213 416 01	WNI M16 Twist nipple	400	292	249 063 01	ADR M63 Sealing ring	400	296
213 420 01	WNI M20 Twist nipple	400	292	251 112 01	ARI Pg 9 Adapter ring	400	296
213 425 01	WNI M25 Twist nipple	400	292	251 216 01	ARI Pg 11 Adapter ring	400	296
213 432 01	WNI M32 Twist nipple	400	292	251 420 01	ARI Pg 16 Adapter ring	400	296
216 420 01	SNI M20 Stepped nipple	400	294	251 525 01	ARI Pg 21 Adapter ring	400	296
216 425 01	SNI M25 Stepped nipple	400	294	251 632 01	ARI Pg 29 Adapter ring	400	296
216 432 01	SNI M32 Stepped nipple	400	294	260 020 01	DMS M20/sw Double-membrane seals	400	293
216 440 01	SNI M40 Stepped nipple	400	294	260 025 01	DMS M25/sw Double-membrane seals	400	293
227 020 01	KVR M20-MGM/sw Cable gland	400	295	260 032 01	DMS M32/sw Double-membrane seals	400	293
227 021 01	KVR M20-GDB/MGM/sw Cable gland	400	295	260 416 01	DMS M16 Double-membrane seals	400	71
227 025 01	KVR M25-MGM/sw Cable gland	400	295	260 420 01	DMS M20 Double-membrane seals	400	71
227 032 01	KVR M32-MGM/sw Cable gland	400	295	260 425 01	DMS M25 Double-membrane seals	400	71
227 040 01	KVR M40-MGM/sw Cable gland	400	295	260 432 01	DMS M32 Double-membrane seals	400	71
227 050 01	KVR M50-MGM/sw Cable gland	400	295	260 433 01	DMS M32/4 Double-membrane seals	400	293
227 412 01	KVR M12-MGM Cable gland	400	71	260 440 01	DMS M40 Double-membrane seals	400	71
227 416 01	KVR M16-MGM Cable gland	400	71	262 020 01	BST M20/sw Ventilation seal	400	172
227 420 01	KVR M20-MGM Cable gland	400	71	262 412 01	DAE M12 Pressure balance element	400	237
227 421 01	KVR M20-GDB/MGM Cable gland	400	71	262 420 01	BST M20 Ventilation seal	400	163
227 425 01	KVR M25-MGM Cable gland	400	71	263 440 01	BEL Air M40 Ventilation element	400	294
227 432 01	KVR M32-MGM Cable gland	400	71	288 416 01	RST M16 Conduit connector	400	296
227 440 01	KVR M40-MGM Cable gland	400	71	288 420 01	RST M20 Conduit connector	400	296
227 450 01	KVR M50-MGM Cable gland	400	71	288 421 01	RST M20-16 Conduit connector	400	296
227 463 01	KVR M63-MGM Cable gland	400	71	288 422 01	RST M20-19 Conduit connector	400	296
227 620 01	KVR M20-MGM/or Cable gland	400	83	288 425 01	RST M25 Conduit connector	400	296
227 625 01	KVR M25-MGM/or Cable gland	400	83	288 432 01	RST M32 Conduit connector	400	296
227 632 01	KVR M32-MGM/or Cable gland	400	83	300 407 01	VST RR Sealing plugs	400	60
227 640 01	KVR M40-MGM/or Cable gland	400	83	301 011 01	Rapid-Box 2,5-16 ² KV 1 x 5 Junction box	220	110
230 416 01	AST M16 Attachment bushes	400	139	301 021 01	Rapid-Box 2,5-16 ² KV 2 x 5 Junction box	220	110
230 420 01	AST M20 Attachment bushes	400	139	301 031 01	Rapid-Box 2,5-16 ² STV 1 x 3-pole Junction box	220	110
230 425 01	AST M25 Attachment bushes	400	139	301 041 01	Rapid-Box 2,5-16 ² STV 2 x 3-pole Junction box	220	110
230 432 01	AST M32 Attachment bushes	400	139	301 051 01	Rapid-Box 2,5-16 ² STV 1 x 5-pole Junction box	220	110
230 440 01	AST M40 Attachment bushes	400	139	301 061 01	Rapid box 2,5-16 ² STV 2 x 5-pole Junction box	220	110

Order-No.	Description	Disc. Group	Page	Order-No.	Description	Disc. Group	Page
301 111 01	Rapid-Box 10-50 ² KV 1 x 5 Junction box	220	109	332 712 01	i 12 SB-L Junction box	100	54
301 121 01	Rapid-Box 10-50 ² KV 2 x 5 Junction box	220	109	332 907 01	Sd 7-L Junction box	100	53
301 131 01	Rapid-Box 10-50 ² STV 1 x 3-pole Junction box	220	109	332 912 01	i 12-L Junction box	100	54
301 141 01	Rapid-Box 10-50 ² STV 2 x 3-pole Junction box	220	109	333 416 01	i 16-2,5 ² Junction box	100	55
301 151 01	Rapid-Box 10-50 ² STV 1 x 5-pole Junction box	220	109	333 916 01	i 16-L Junction box	100	55
301 161 01	Rapid-Box 10-50 ² STV 2 x 5-pole Junction box	220	109	334 412 01	Q 12-2,5 ² Junction box	100	59
301 211 01	Rapid-Box E90 2.5-16 ² KV 1 x 5 Junction box	220	116	334 712 01	Q 12 SB-L Junction box	100	59
301 221 01	Rapid-Box E90 2.5-16 ² KV 2 x 5 Junction box	220	116	334 904 01	Q 4-L Junction box	100	59
301 231 01	Rapid-Box E90 2.5-16 ² STV 1 x 3-pole Junction box	220	117	334 912 01	Q 12-L Junction box	100	59
301 241 01	Rapid-Box E90 2.5-16 ² STV 2 x 3-pole Junction box	220	117	344 001 01	ZEL 2K-12 Junction box	100	60
301 251 01	Rapid-Box E90 2.5-16 ² STV 1 x 5-pole Junction box	220	117	344 012 01	2K-12-L/br Junction box	100	54
301 261 01	Rapid-Box E90 2.5-16 ² STV 2 x 5-pole Junction box	220	117	344 112 01	2K-12-2,5 ² /w Junction box	100	54
301 311 01	Rapid-Box E90 10-50 ² KV 1 x 5 Junction box	220	115	344 412 01	2K-12-2,5 ² Junction box	100	54
301 321 01	Rapid-Box E90 10-50 ² KV 2 x 5 Junction box	220	115	344 612 01	2K-12-L/w Junction box	100	54
301 331 01	Rapid-Box E90 10-50 ² STV 1 x 3-pole Junction box	220	115	344 912 01	2K-12-L Junction box	100	54
301 341 01	Rapid-Box E90 10-50 ² STV 2 x 3-pole Junction box	220	115	345 112 01	2K-12 AB-2,5 ² /w Junction box	100	55
301 351 01	Rapid-Box E90 10-50 ² STV 1 x 5-pole Junction box	220	115	345 412 01	2K-12 AB-2.5 ² Junction box	100	55
301 361 01	Rapid-Box E90 10-50 ² STV 2 x 5-pole Junction box	220	115	345 612 01	2K-12 AB-L/w Junction box	100	55
301 411 01	Rapid-Box E30 2,5-16 ² KV 1 x 5 Junction box	220	112	345 912 01	2K-12 AB-L Junction box	100	55
301 421 01	Rapid-Box E30 2,5-16 ² KV 2 x 5 Junction box	220	112	346 116 01	2K-16-2,5 ² /w Junction box	100	56
301 431 01	Rapid-Box E30 2,5-16 ² STV 1 x 3-pole Junction box	220	112	346 416 01	2K-16-2,5 ² Junction box	100	56
301 441 01	Rapid-Box E30 2,5-16 ² STV 2 x 3-pole Junction box	220	112	346 616 01	2K-16-L/w Junction box	100	56
301 451 01	Rapid-Box E30 2,5-16 ² STV 1 x 5-pole Junction box	220	112	346 916 01	2K-16-L Junction box	100	56
301 461 01	Rapid-Box E30 2,5-16 ² STV 2 x 5-pole Junction box	220	112	348 116 01	2K-16 AB-2,5 ² /w Junction box	100	56
301 511 01	Rapid-Box E30 10-50 ² KV 1 x 5 Junction box	220	111	348 416 01	2K-16 AB-2,5 ² Junction box	100	56
301 521 01	Rapid-Box E30 10-50 ² KV 2 x 5 Junction box	220	111	348 616 01	2K-16 AB-L/w Junction box	100	56
301 531 01	Rapid box E30 10-50 ² STV 1 x 3-pole Junction box	220	111	348 916 01	2K-16 AB-L Junction box	100	56
301 541 01	Rapid-Box E30 10-50 ² STV 2 x 3-pole Junction box	220	111	370 400 01	KD GN-SND Strain relief	100	291
301 551 01	Rapid-Box E30 10-50 ² STV 1 x 5-polig Junction box	220	111	370 402 01	KD ZEL Strain relief	100	291
301 561 01	Rapid-Box E30 10-50 ² STV 2 x 5-polig Junction box	220	111	372 100 01	KD EBZ-CEE Installation kit	100	290
301 611 01	Rapid-Box E60 2,5-16 ² KV 1 x 5 Junction box	220	114	402 407 01	WK 007-2,5 ² Junction box	140	67
301 621 01	Rapid-Box E60 2,5-16 ² KV 2 x 5 Junction box	220	114	402 907 01	WK 007-L Junction box	140	67
301 631 01	Rapid-Box E60 2,5-16 ² STV 1 x 3-polig Junction box	220	114	404 407 01	WK 040-4 ² Junction box	140	67
301 641 01	Rapid-Box E60 2,5-16 ² STV 2 x 3-polig Junction box	220	114	404 907 01	WK 040-L Junction box	140	67
301 651 01	Rapid-Box E60 2,5-16 ² STV 1 x 5-polig Junction box	220	114	406 406 01	WK 060-6 ² Junction box	140	68
301 661 01	Rapid-Box E60 2,5-16 ² STV 2 x 5-polig Junction box	220	114	406 906 01	WK 060-L Junction box	140	68
301 711 01	Rapid-Box E60 10-50 ² KV 1 x 5 Junction box	220	113	410 406 01	WK 100-10 ² Junction box	140	68
301 721 01	Rapid-Box E60 10-50 ² KV 2 x 5 Junction box	220	113	410 906 01	WK 100-L Junction box	140	68
301 731 01	Rapid-Box E60 10-50 ² STV 1 x 3-polig Junction box	220	113	416 412 01	WK 160-16 ² Junction box	140	69
301 741 01	Rapid-Box E60 10-50 ² STV 2 x 3-polig Junction box	220	113	416 912 01	WK 160-L Junction box	140	69
301 751 01	Rapid-Box E60 10-50 ² STV 1 x 5-polig Junction box	220	113	425 416 01	WK 250-25 ² Junction box	140	69
301 761 01	Rapid-Box E60 10-50 ² STV 2 x 5-polig Junction box	220	113	425 916 01	WK 250-L Junction box	140	69
306 406 01	UP 6-2,5 ² Junction box	100	60	455 907 01	WK 040-S Junction box	140	67
306 906 01	UP 6-L Junction box	100	60	460 506 01	WK 060 KLS-6 ² Terminal block	140	50
310 408 01	Mini 25-2,5 ² Junction box	100	53	460 510 01	WK 100 KLS-10 ² Terminal block	140	50
310 908 01	Mini 25-L Junction box	100	53	460 516 01	WK 160 KLS-16 ² Terminal block	140	50
315 107 01	AP 7 - 2,5 ² Junction box	100	60	460 525 01	WK 007 KLS-2,5 ² Terminal block	140	49
315 607 01	AP 7 - L Junction box	100	60	460 535 01	WK 250 KLS-25 ² Terminal block	140	50
320 970 01	HP 70-L Junction box	100	63	480 425 01	Abox HA 250 Junction box	120	44
322 980 01	HP 80-L Junction box	100	63	480 435 01	Abox HA 350 Junction box	120	44
325 990 01	HP 90-L Junction box	100	64	490 106 01	Abox-i SL-2,5/4 ² Junction box	120	39
326 900 01	HP 100-L Junction box	100	64	490 402 01	Abox-i 025-2,5 ² Junction box	130	31
326 950 01	HP 150-L Junction box	100	65	490 404 01	Abox-i 040-4 ² Junction box	130	32
326 990 01	HP 190-L Junction box	100	65	490 406 01	Abox-i 060-6 ² Junction box	130	33
332 112 01	i 12 -2,5 ² /w Junction box	100	54	490 410 01	Abox-i 100-10 ² Junction box	130	33
332 212 01	i 12 -L/sw Junction box	100	54	490 416 01	Abox-i 160-16 ² Junction box	130	34
332 407 01	Sd 7-2,5 ² Junction box	100	53	490 425 01	Abox-i 250 25 ² Junction box	130	34
332 412 01	i 12-2,5 ² Junction box	100	54	490 435 01	Abox-i 350-35 ² Junction box	130	35
332 512 01	i 12-L/gr Junction box	100	54	490 470 01	Abox-i 700-70 ² Junction box	130	35
332 612 01	i 12-L/w Junction box	100	54	490 485 01	Abox-i 1500-150 ² Junction box	130	36
332 707 01	Sd 7 SB-L Junction box	100	53	490 494 01	Abox-i 2400-240 ² Junction box	130	37

Order-No.	Description	Disc. Group	Page	Order-No.	Description	Disc. Group	Page
490 585 01	Abox-i 1500 DK-150 ² Junction box	130	36	567 412 01	KF 12 Hinged window	310	165
490 594 01	Abox-i 2400 DK-240 ² Junction box	130	37	568 012 01	SF 12 Inspection window	310	165
490 702 01	Abox-i 025 SB-L Junction box	130	31	591 061 01	SVI A 6 Distribution board	311	239
490 704 01	Abox-i 040 SB-L Junction box	130	32	591 064 01	SVI A 2x6 Distribution board	311	239
490 810 01	Abox-i 5L-6 ² Junction box	130	39	591 100 01	AK KS-IP30 Combi set	310	162
490 816 01	Abox-i 5L-10 ² Junction box	130	40	591 110 01	SVI L-t Empty enclosure	311	240
490 835 01	Abox-i 5L-16 ² Junction box	130	40	591 112 01	SVI L-th Empty enclosure	311	240
490 902 01	Abox-i 025-L Junction box	130	31	591 113 01	SVI LS-t Empty enclosure	311	240
490 904 01	Abox-i 040-L Junction box	130	32	591 114 01	SVI LS-th Empty enclosure	311	240
490 906 01	Abox-i 060-L Junction box	130	33	591 120 01	SVI L-g Empty enclosure	311	240
490 910 01	Abox-i 100-L Junction box	130	33	591 121 01	SVI L-gh Empty enclosure	311	240
490 916 01	Abox-i 160-L Junction box	130	34	591 122 01	SVI LS-g Empty enclosure	311	240
490 925 01	Abox-i 250-L Junction box	130	34	591 123 01	SVI LS-gh Empty enclosure	311	240
490 935 01	Abox-i 350-L Junction box	130	35	591 132 01	SVI A 12 Distribution board	311	239
491 402 01	Abox-i 025-2,5 ² /sw Junction box	130	31	591 210 01	SVI LQ-t Empty enclosure	311	240
491 404 01	Abox-i 040-4 ² /sw Junction box	130	32	591 220 01	SVI LQ-g Empty enclosure	311	240
491 406 01	Abox-i 060-6 ² /sw Junction box	130	33	591 900 01	SVI MPI Empty enclosure	311	241
491 410 01	Abox-i 100-10 ² /sw Junction box	130	33	591 906 01	NS35-125 Standard rail	311	241
491 416 01	Abox-i 160-16 ² /sw Junction box	130	34	591 912 01	NS35-260 Standard rail	311	241
491 435 01	Abox-i 350-35 ² /sw Junction box	130	35	600 407 01	RKK 4/07-7x4 ² Terminal block housing	250	120
491 902 01	Abox-i 025-L/sw Junction box	130	31	600 412 01	RKK 4/12 XL-12x4 ² Terminal block housing	250	122
491 903 01	Abox-i 025 AB-L/sw Junction box	130	31	600 418 01	RKK 4/18-18x4 ² Terminal block housing	250	123
491 904 01	Abox-i 040-L/sw Junction box	130	32	605 404 01	RKK 4/05-5x4 ² Terminal block housing	250	120
491 905 01	Abox-i 040 AB-L/sw Junction box	130	32	606 404 01	RKK 4/08-8x4 ² Terminal block housing	250	120
491 906 01	Abox-i 060-L/sw Junction box	130	33	607 404 01	RKK 4/10-10x4 ² Terminal block housing	250	121
491 910 01	Abox-i 100-L/sw Junction box	130	33	610 007 01	RK 4/07 SL-7x4 ² Terminal block housing	250	128
491 916 01	Abox-i 160-L/sw Junction box	130	34	610 012 01	RK 4/12 SL-12x4 ² Terminal block housing	250	128
491 935 01	Abox-i 350-L/sw Junction box	130	35	610 018 01	RK 4/18 KSL-18x4 ² Terminal block housing	250	129
492 402 01	Abox XT 025-2,5 ² Junction box	130	42	610 019 01	RK 4/18 SL-18x4 ² Terminal block housing	250	129
492 404 01	Abox XT 040-4 ² Junction box	130	42	610 025 01	RK 4/25 SL-25x4 ² Terminal block housing	250	130
492 406 01	Abox XT 060-6 ² Junction box	130	43	610 034 01	RK 4/34 SL-34x4 ² Terminal block housing	250	130
492 410 01	Abox XT 100-10 ² Junction box	130	43	610 050 01	RK 4/50 SL-50x4 ² Terminal block housing	250	131
492 502 01	GHB 1 Cast-resin bag	120	42	610 100 01	RK 4/100 SL-100x4 ² Terminal block housing	250	131
492 504 01	GHB 2 Cast-resin bag	120	42	610 404 01	RKK 4/12-12x4 ² Terminal block housing	250	121
492 506 01	GHB 3 Cast-resin bag	120	43	612 404 01	RKK 4/15-15x4 ² Terminal block housing	250	122
492 510 01	GHB 4 Cast-resin bag	120	43	613 906 01	RK 4/12-L Empty enclosure	250	128
494 402 01	Abox-i 025 AB-2,5 ² Junction box	130	31	614 404 01	RKK 4/22-22x4 ² Terminal block housing	250	123
494 404 01	Abox-i 040 AB-4 ² Junction box	130	32	615 007 01	RK 4/07-7x4 ² Terminal block housing	250	128
494 702 01	Abox-i 025 SB AB-L Junction box	130	31	615 012 01	RK 4/12-12x4 ² Terminal block housing	250	128
494 707 01	Abox-i 040 SB AB-L Junction box	130	32	615 018 01	RK 4/18 K-18x4 ² Terminal block housing	250	129
494 902 01	Abox-i 025 AB-L Junction box	130	31	615 019 01	RK 4/18-18x4 ² Terminal block housing	250	129
494 904 01	Abox-i 040 AB-L Junction box	130	32	615 025 01	RK 4/25-25x4 ² Terminal block housing	250	130
496 402 01	Abox-i m 025-2,5 ² Junction box	130	28	615 034 01	RK 4/34-34x4 ² Terminal block housing	250	130
496 902 01	Abox-i m 025-L Junction box	130	28	615 050 01	RK 4/50-50x4 ² Terminal block housing	250	131
498 402 01	Abox-i m 025-2,5 ² /sw Junction box	130	28	615 100 01	RK 4/100-100x4 ² Terminal block housing	250	131
498 902 01	Abox-i m 025-L/sw Junction box	130	28	615 912 01	RK 4/18 K-L Empty enclosure	250	129
499 402 01	Abox-i m 025 AB-2,5 ² Junction box	130	28	616 912 01	RK 4/18-L Empty enclosure	250	129
499 902 01	Abox-i m 025 AB-L Junction box	130	28	616 950 01	RK 4/50-L Empty enclosure	250	131
499 903 01	Abox-i m 025 AB-L/sw Junction box	130	28	619 907 01	RK 4/07-L Empty enclosure	250	128
500 025 01	NAL 2 m-516 Power cord kit	600	171	620 034 01	RKA 4/34 SL-34x4 ² Terminal block housing	250	132
500 040 01	NAL 2 m-532 Power cord kit	600	171	620 068 01	RKA 4/68 SL-68x4 ² Terminal block housing	250	133
501 404 01	Abox-i m 040-4 ² Junction box	130	29	620 102 01	RKA 4/102 SL-102x4 ² Terminal block housing	250	134
501 904 01	Abox-i m 040-L Junction box	130	29	620 136 01	RKA 4/136 SL-136x4 ² Terminal block housing	250	135
502 404 01	Abox-i m 040-4 ² /sw Junction box	130	29	625 034 01	RKA 4/34-34x4 ² Terminal block housing	250	132
502 904 01	Abox-i m 040-L/sw Junction box	130	29	625 068 01	RKA 4/68-68x4 ² Terminal block housing	250	133
503 404 01	Abox-i m 040 AB-4 ² Junction box	130	29	625 102 01	RKA 4/102-102x4 ² Terminal block housing	250	134
503 904 01	Abox-i m 040 AB-L Junction box	130	29	625 136 01	RKA 4/136-136x4 ² Terminal block housing	250	135
503 905 01	Abox-i m 040 AB-L/sw Junction box	130	29	625 916 01	RK 4/25-L Empty enclosure	250	130
510 038 01	KD BD/Schuko® Blank cover	310	170	625 917 01	RK 4/34-L Empty enclosure	250	130
510 060 01	KD BD/CEE Blank cover	310	170	626 922 01	RK 4/100-L Empty enclosure	250	131
562 735 01	AK NS35-250 Standard rail	310	165	629 901 01	RKA 4/34-L Empty enclosure	250	132

Order-No.	Description	Disc. Group	Page	Order-No.	Description	Disc. Group	Page
629 902 01	RKA 4/68-L Empty enclosure	250	133	733 829 01	AK3 KFL Flange for AK-F	320	152
629 903 01	RKA 4/102-L Empty enclosure	250	134	733 830 01	AK3 KS M50 Combination cable gland M50	320	152
629 904 01	RKA 4/136-L Empty enclosure	250	135	733 831 01	AK3 KBL Cable cover with document compartment	320	152
630 404 01	RKKi 4/12-12x4 ² Terminal block housing	250	125	733 832 01	AK3 TW Partition wall	320	153
630 407 01	RKKi 4/07-7x4 ² Terminal block housing	250	124	733 833 01	AK3 ABL-ES External fixing lugs	320	153
630 412 01	RKKi 4/12 XL-12x4 ² Terminal block housing	250	126	733 834 01	AK3 STD shroud contactsgrowing putlet	320	152
630 418 01	RKKi 4/18-18x4 ² Terminal block housing	250	127	733 835 01	AK3 MPI Mounting plate	320	153
632 404 01	RKKi 4/15-15x4 ² Terminal block housing	250	126	733 837 01	AK3 AS External hinge	320	153
634 404 01	RKKi 4/22-22x4 ² Terminal block housing	250	127	733 838 01	AK3 MPI 14 L Mounting plate	320	153
635 404 01	RKKi 4/05-5x4 ² Terminal block housing	250	124	735 403 01	AK 03 Small-scale distributors	320	159
636 404 01	RKKi 4/08-8x4 ² Terminal block housing	250	124	735 405 01	AK 05 Small-scale distributors	320	159
637 404 01	RKKi 4/10-10x4 ² Terminal block housing	250	125	735 409 01	AK 09 Small-scale distributors	320	159
670 650 01	URS RK1-150 mm ² Terminal block	450	49	735 412 01	AK 12 Small-scale distributors	320	159
670 740 01	URS RK1-240mm ² Terminal block	450	49	735 424 01	AK 24 Small-scale distributors	320	159
685 020 01	HandyGrip VG 20 Terminal strip	450	70	735 503 01	AKe 03 Small-scale distributors	310	155
685 021 01	HandyGrip VG 21 Terminal strip	450	70	735 505 01	AKe 05 Small-scale distributors	310	155
685 121 01	HandyGrip VG 21 w Terminal strip	450	70	735 509 01	AKe 09 Small-scale distributors	310	155
688 310 01	HandyQuick SQ 31 Screwless terminal	450	70	735 512 01	AKe 12 Small-scale distributors	310	156
688 320 01	HandyQuick SQ 32 Screwless terminal	450	70	735 536 01	AKe 36 Small-scale distributors	310	156
688 520 01	HandyQuick SQ 52 Screwless terminal	450	70	735 548 01	AKe 48 Small-scale distributors	310	157
706 102 01	AK SGA-1 Lock fittings	320	163	735 603 01	AKe 03-L Small-scale distributors	310	155
706 104 01	AK SRS Lock bolt set	320	164	735 605 01	AKe 05-L Small-scale distributors	310	155
706 902 01	AK SGA-2 Lock fittings	320	163	735 609 01	AKe 09-L Small-scale distributors	310	155
728 902 01	STV 502-L Empty enclosure	311	169	735 612 01	AKe 12-L Small-scale distributors	310	156
728 904 01	STV 504-L Empty enclosure	311	169	735 636 01	AKe 36-L Small-scale distributors	310	156
728 912 01	STV 512-L Empty enclosure	311	169	735 648 01	AKe 48-L Small-scale distributors	310	157
729 904 01	STV 904-L Empty enclosure	311	169	735 724 01	AKe 24 Small-scale distributors	310	156
729 912 01	STV 912-L Empty enclosure	311	169	735 824 01	AKe 24-L Small-scale distributors	310	156
729 922 01	STV 922-L Empty enclosure	311	169	736 403 01	AKi 03 Small-scale distributors	340	160
729 923 01	STV 923-L Empty enclosure	311	169	736 405 01	AKi 05 Small-scale distributors	340	160
731 908 01	STV 1208-L Empty enclosure	311	169	736 409 01	AKi 09 Small-scale distributors	340	160
731 922 01	STV 1222-L Empty enclosure	311	169	736 412 01	AKi 12 Small-scale distributors	340	161
731 924 01	STV 1224-L Empty enclosure	311	169	736 424 01	AKi 24 Small-scale distributors	340	161
733 310 01	AK-F/DMS 14 L-g Empty enclosure	320	151	740 401 01	AKL 1-g Empty enclosure	321	226
733 311 01	AK-F/DMS 14 L-t Empty enclosure	320	151	740 402 01	AKL 2-g Empty enclosure	321	226
733 410 01	AK 14 L-g Empty enclosure	320	149	740 403 01	AKL 3-g Empty enclosure	321	228
733 411 01	AK 14 L-t Empty enclosure	320	149	740 404 01	AKL 4-g Empty enclosure	321	228
733 414 01	AK 14 Small-scale distributors	320	144	741 401 01	AKi 1-g Empty enclosure	340	226
733 428 01	AK 28 Small-scale distributors	320	144	741 402 01	AKi 2-g Empty enclosure	340	226
733 442 01	AK 42 Small-scale distributors	320	145	741 403 01	AKi 3-g Empty enclosure	340	228
733 456 01	AK 56 Small-scale distributors	320	146	741 404 01	AKi 4-g Empty enclosure	340	228
733 470 01	AK 70 Small-scale distributors	320	146	741 901 01	AKi-R 4/34-L Empty enclosure	341	132
733 510 01	AK-F 14 L-g Empty enclosure	320	150	741 902 01	AKi-R 4/68-L Empty enclosure	341	133
733 511 01	AK-F 14 L-t Empty enclosure	320	150	741 903 01	AKi-R 4/102-L Empty enclosure	341	134
733 514 01	AK-F 14 Small-scale distributors	320	147	741 904 01	AKi-R 4/136-L Empty enclosure	341	135
733 528 01	AK-F 28 Small-scale distributors	320	147	742 034 01	AKi-R 4/34 Terminal block housing	341	132
733 542 01	AK-F 42 Small-scale distributors	320	148	742 068 01	AKi-R 4/68 Terminal block housing	341	133
733 556 01	AK-F 56 Small-scale distributors	320	148	742 102 01	AKi-R 4/102 Terminal block housing	341	134
733 614 01	AK 14 Plus Small-scale distributors	320	144	742 136 01	AKi-R 4/136 Terminal block housing	341	135
733 628 01	AK 28 Plus Small-scale distributors	320	144	742 902 01	AKL 2-gh Empty enclosure	321	226
733 642 01	AK 42 Plus Small-scale distributors	320	145	742 903 01	AKL 3-gh Empty enclosure	321	228
733 714 01	AK-F 14 Plus Small-scale distributors	320	147	742 904 01	AKL 4-gh Empty enclosure	321	228
733 728 01	AK-F 28 Plus Small-scale distributors	320	147	743 034 01	AKi-R 4/34-SL Terminal block housing	341	132
733 742 01	AK-F 42 Plus Small-scale distributors	320	148	743 068 01	AKi-R 4/68-SL Terminal block housing	341	133
733 801 01	AK3 KF Hinged window	320	153	743 102 01	AKi-R 4/102-SL Terminal block housing	341	134
733 812 01	AK3 NS35-14 Standard rail	320	153	743 136 01	AKi-R 4/136-SL Terminal block housing	341	135
733 813 01	AK3 NS35-275 Standard rail	320	153	743 902 01	AKi 2-gh Empty enclosure	340	226
733 820 01	AK3 FLO0 Flange for AK-F	320	152	743 903 01	AKi 3-gh Empty enclosure	340	228
733 821 01	AK3 FLO1 Flange for AK-F	320	152	743 904 01	AKi 4-gh Empty enclosure	340	228
733 822 01	AK3 FLO2 Flange for AK-F	320	152	744 001 01	AKL 1-t Empty enclosure	321	226
733 828 01	AK3 FL13 Flange for AK-F	320	152	744 002 01	AKL 2-t Empty enclosure	321	226

Order-No.	Description	Disc. Group	Page	Order-No.	Description	Disc. Group	Page
744 003 01	AKL 3-t Empty enclosure	321	228	803 107 01	Abox 025 AB-2,5 ² /w Junction box	120	18
744 004 01	AKL 4-t Empty enclosure	321	228	803 407 01	Abox 025 AB-2,5 ² Junction box	120	18
745 001 01	AKi 1-t Empty enclosure	340	226	803 427 01	Abox 025 AB-Pot Junction box	120	18
745 002 01	AKi 2-t Empty enclosure	340	226	803 607 01	Abox 025 AB-L/w Junction box	120	18
745 003 01	AKi 3-t Empty enclosure	340	228	803 907 01	Abox 025 AB-L Junction box	120	18
745 004 01	AKi 4-t Empty enclosure	340	228	804 107 01	Abox 040-4,0 ² /w Junction box	120	19
746 902 01	AKL 2-th Empty enclosure	321	226	804 407 01	Abox 040-4,0 ² Junction box	120	19
746 903 01	AKL 3-th Empty enclosure	321	228	804 607 01	Abox 040-L/w Junction box	120	19
746 904 01	AKL 4-th Empty enclosure	321	228	804 707 01	Abox 040 SB-L Junction box	120	19
747 902 01	AKi 2-th Empty enclosure	340	226	804 907 01	Abox 040-L Junction box	120	19
747 903 01	AKi 3-th Empty enclosure	340	228	805 407 01	Abox 040 AB-4 ² Junction box	120	19
747 904 01	AKi 4-th Empty enclosure	340	228	805 607 01	Abox 040 AB-L/w Junction box	120	19
790 007 01	AK N 17-S Terminal rails	320	167	805 907 01	Abox 040 AB-L Junction box	120	19
790 047 01	AK N 47-S Terminal rails	320	167	806 107 01	Abox SL-2,5/4 ² Junction box	120	25
790 204 01	AK 03 PEN-S Terminal rails	320	166	806 407 01	Abox 060-6 ² Junction box	120	20
790 205 01	AK 05 PEN-S Terminal rails	320	166	806 707 01	Abox 060 SB-L Junction box	120	20
790 207 01	AK 09 PEN-S Terminal rails	320	166	806 907 01	Abox 060-L Junction box	120	20
790 211 01	AK 12 PEN-S Terminal rails	320	166	807 407 01	Abox m 025-2,5 ² Junction box	120	15
790 217 01	AK 14/28 PEN-S Terminal rails	320	166	807 707 01	Abox m 025 SB-L Junction box	120	15
790 218 01	AK 24 PEN-S Terminal rails	320	166	807 907 01	Abox m 025-L Junction box	120	15
790 225 01	AK 42 PEN-S Terminal rails	320	166	808 407 01	Abox m 025 AB-2,5 ² Junction box	120	15
790 317 01	AK 14 PEN-SL Screwless terminal rail	320	166	808 707 01	Abox m 025 AB SB-L Junction box	120	15
790 318 01	AK N-SL Screwless terminal rail	320	166	808 907 01	Abox m 025 AB-L Junction box	120	15
790 327 01	AK 28 PEN-SL Screwless terminal rail	320	166	810 410 01	Abox 100-10 ² Junction box	120	20
790 805 01	KLS PE 35 Terminal block	310	166	810 810 01	Abox SL-6 ² Junction box	120	25
790 905 01	KLS N 35 Terminal block	310	166	810 910 01	Abox 100-L Junction box	120	20
791 001 01	AK KS-IP65 Combi set	320	162	811 407 01	Abox m 040-4 ² Junction box	120	16
791 002 01	STV KS-IP 65 Combi set	311	170	811 707 01	Abox m 040 SB-L Junction box	120	16
792 400 01	AK KBL Cable cover	320	164	811 907 01	Abox m 040-L Junction box	120	16
793 004 01	AK ABL-E5 External fixing lugs	320	165	812 407 01	Abox m 040 AB-4 ² Junction box	120	16
793 100 01	AKi WSD Weather protection cover	340	171	812 907 01	Abox m 040 AB-L Junction box	120	16
795 001 01	AK MPI 1 Mounting plate	320	230	816 410 01	Abox 160-16 ² Junction box	120	21
795 002 01	AK MPI 2 Mounting plate	320	230	816 810 01	Abox SL-10 ² Junction box	120	26
795 003 01	AK MPI 3 Mounting plate	320	22	816 910 01	Abox 160-L Junction box	120	21
795 004 01	AK MPI 4 Mounting plate	320	230	825 410 01	Abox 250-25 ² Junction box	120	21
795 012 01	AK MPS 2 Mounting plate	320	230	825 910 01	Abox 250-L Junction box	120	21
795 013 01	AK MPS 3 Mounting plate	320	230	835 410 01	Abox 350-35 ² Junction box	120	22
795 014 01	AK MPS 4 Mounting plate	320	230	835 810 01	Abox SL-16 ² Junction box	120	26
795 020 01	TR NS35-20 Standard support rails	340	230	835 910 01	Abox 350-L Junction box	120	22
795 030 01	NS35-216/3 Standard rail	320	22	840 004 01	Abox 025/040 KLS-2,5 ² /4 ² Terminal block	120	45
795 034 01	TR NS35-34 Standard support rails	340	230	840 006 01	Abox 060 KLS-6 ² Terminal block	120	45
795 042 01	TR NS35-42 Standard support rails	340	230	840 010 01	Abox 100 KLS-10 ² Terminal block	120	45
795 045 01	AK NS35-406 Standard rail	320	230	840 016 01	Abox 160 KLS-16 ² Terminal block	120	45
795 048 01	AK ABF 1 Enclosure wall	320	163	840 035 01	Abox 250/350 KLS-25 ² /35 ² Terminal block	120	45
795 050 01	AK ABF 2 Enclosure wall smooth	320	163	840 070 01	Abox 700 KLS-70 ² Terminal block	120	22
795 058 01	TR NS35-58 Standard support rails	340	230	860 103 01	WKE 1 - 5 x 2,5 ² Cable junction box	200	79
795 060 01	AK NS35-556 Standard rail	320	230	860 254 01	WKE 54 Junction box for tunnel	200	101
795 064 01	TR NS35-64 Standard support rails	340	230	860 400 01	WKE 200 ABL External attachment set	200	91
795 091 01	TR NS35-91 Standard support rails	340	230	860 502 01	WKE 2 - 5 x 6 ² Cable junction box	200	79
795 413 01	SR NS35 Screw set	340	230	860 503 01	WKE 3 - 5 x 10 ² Cable junction box	200	80
796 050 01	AKi ABF 2 Enclosure wall	340	163	860 504 01	WKE 4 - 5 x 16 ² Cable junction box	200	81
796 051 01	AKi ABF 1 Enclosure wall	340	163	860 505 01	WKE 5 - 15 x 6 ² Cable junction box	200	82
797 910 01	AK TW Partition wall	320	164	860 505 20	WKE 5 - 20 x 6 ² Cable junction box	200	82
799 012 01	AK AS Masking off strips	320	164	860 505 24	WKE 5 - 24 x 6 ² Cable junction box	200	83
799 013 01	AK AS-v Masking off strips	340	164	860 512 01	WKE 2 - 3 x 10 ² Cable junction box	200	80
799 103 01	AK BC Reserve compartment	320	164	860 514 01	WKE 4 - 8 x 6 ² Cable junction box	200	81
802 107 01	Abox 025-2,5 ² /w Junction box	120	18	861 400 01	WKE 2 - Duo 3 x 6 ² Cable junction box	200	75
802 407 01	Abox 025-2,5 ² Junction box	120	18	861 410 01	WKE 4 - Duo 5 x 6 ² Cable junction box	200	76
802 607 01	Abox 025-L/w Junction box	120	18	861 420 01	WKE 5 - Duo 7 x 6 ² Cable junction box	200	77
802 707 01	Abox 025 SB-L Junction box	120	18	861 500 01	WKE 4 - Duo 3 x 10 ² Cable junction box	200	76
802 907 01	Abox 025-L Junction box	120	18	861 510 01	WKE 5 - Duo 5 x 10 ² Cable junction box	200	78

Order-No.	Description	Disc. Group	Page	Order-No.	Description	Disc. Group	Page
861 600 01	WKE 4 - Duo 3 x 16 ² Cable junction box	200	77	923 350 01	HW 050/2 WD Double Socket	100	284
861 610 01	WKE 5 - Duo 5 x 16 ² Cable junction box	200	78	924 040 01	HW 040 Outlet socket	100	282
861 710 01	WKE 3 - Duo 3 x 6 ² / 2 x 6 ² Cable junction box	200	75	925 070 01	HW 070 Junction box	100	284
862 202 01	WKE 202 RK Cable junction box	200	87	925 100 01	HW VD-67 Sealing cap	100	250
862 203 01	WKE 203 RK Cable junction box	200	87	925 101 01	HW VD-60 Sealing cap	100	262
862 204 01	WKE 204 RK Cable junction box	200	88	925 120 01	HW 120 Junction box	100	284
862 262 01	WKE 304 SB Cable junction box	200	98	925 121 01	HW LFR-120 HW hole cutter	100	267
862 302 01	WKE 302 RK Cable junction box	200	88	925 135 01	HW LFR-35 HW hole cutter	100	279
862 303 01	WKE 303 RK Cable junction box	200	89	925 168 01	HW LFR-68 HW hole cutter	100	279
862 304 01	WKE 304 RK Cable junction box	200	89	925 174 01	HW LFR-74 HW hole cutter	100	279
862 355 01	WKE 407 SB Cable junction box	200	98	925 199 01	HW LFRP-Sort Profi suitcase hole cutter	100	286
862 356 01	WKE 408 SB Cable junction box	200	99	926 935 01	HW LFRP-35 Profi hole cutter	100	286
862 402 01	WKE 402 RK Cable junction box	200	90	926 968 01	HW LFRP-68 Profi hole cutter	100	286
862 403 01	WKE 403 RK Cable junction box	200	90	926 974 01	HW LFRP-74 Profi hole cutter	100	286
862 404 01	WKE 404 RK Cable junction box	200	91	927 050 01	HW DD Ceiling socket	100	283
862 405 01	WKE 405 LSA Cable junction box	200	91	927 100 01	HW 050 DD-VD Sealing cap with ceiling hook	100	285
863 001 01	WKE BS F2A Spare fuses	200	97	928 001 01	HWK 1 Junction box	100	284
863 721 01	WKE 2 - 3/1 x 6 ² SB Cable junction box	200	95	928 002 01	HWK 2 Junction box	100	284
863 747 01	WKE 4 - 4/3 x 6 ² 2SB Cable junction box	200	95	928 003 01	HWK 3 Junction box	100	284
863 748 01	WKE 5 - 4/3 x 16 ² 2SB Cable junction box	200	96	929 935 01	HW LFR-35/SBL Saw blade	100	286
863 921 01	WKE 4 - 3/1 x 16 ² SB Cable junction box	200	96	929 968 01	HW LFR-68/SBL Saw blade	100	286
865 414 01	WKE AK 14 Small scale distributor	220	103	929 969 01	HW LFR-74/SBL Saw blade	100	286
865 428 01	WKE AK 28 Small scale distributor	220	103	970 160 01	U 71 BWD WAD-35 Reinforcement box	520	249
865 442 01	WKE AK 42 Small scale distributor	220	104	970 220 01	RVB 20 Conduit coupling	520	253
865 456 01	WKE AK 56 Small scale distributor	220	104	970 225 01	RVB 25 Conduit coupling	520	253
865 470 01	WKE AK 70 Small scale distributor	220	105	970 232 01	RVB 32 Conduit coupling	520	265
865 514 01	WKE AK 14 R Small scale distributor	220	103	970 240 01	RVB 40 Conduit coupling	520	265
865 528 01	WKE AK 28 R Small scale distributor	220	103	970 425 01	ROK 1 Conduit elbow	520	251
865 542 01	WKE AK 42 R Small scale distributor	220	104	970 430 01	ROK 2 Conduit elbow	520	251
865 556 01	WKE AK 56 R Small scale distributor	220	104	970 435 01	ROK 3 Conduit elbow	520	251
865 570 01	WKE AK 70 R Small scale distributor	220	105	970 500 01	BSK 1 Blank base	520	264
865 614 01	WKE AK 14/2 Small scale distributor	220	105	970 505 01	BSK 2 Blank base	520	264
865 628 01	WKE AK 28/2 Small scale distributor	220	106	970 518 01	ROP 18 Conduit ferrule	520	250
865 642 01	WKE AK 42/2 Small scale distributor	220	106	970 523 01	ROP 23 Conduit ferrule	520	250
865 656 01	WKE AK 56/2 Small scale distributor	220	107	970 530 01	ROP 30 Conduit ferrule	520	250
865 670 01	WKE AK 70/2 Small scale distributor	220	107	970 537 01	ROP 37 Conduit ferrule	520	250
865 714 01	WKE AK 14/2 R Small scale distributor	220	105	970 540 01	U 71 KUT Dome funnel	520	252
865 728 01	WKE AK 28/2 R Small scale distributor	220	106	970 550 01	KUK Dome box	520	252
865 742 01	WKE AK 42/2 R Small scale distributor	220	106	970 560 01	WAD Wall outlet socket	520	246
865 756 01	WKE AK 56/2 R Small scale distributor	220	107	970 562 01	WAD VD Sealing cap	520	246
865 770 01	WKE AK 70/2 R Small scale distributor	220	107	970 618 01	KOT 18 Cone funnel	520	251
870 410 01	Abox 700-70 ² Junction box	120	22	970 623 01	KOT 23 Cone funnel	520	251
870 910 01	Abox 700-L Junction box	120	22	970 630 01	KOT 30 Cone funnel	520	251
890 010 01	Abox PST Sealing kit	120	45	970 637 01	KOT 37 Cone funnel	520	251
890 040 01	KVS Cable gland protection	120	91	970 690 01	VBK Junction boxes	520	252
894 016 01	NS35-144/2 Standard rail	120	46	970 704 01	DAL 4 Universal outlet cleats	520	253
894 035 01	NS35-216/2 Standard rail	120	46	970 705 01	DAL 1 Universal outlet cleats	520	253
895 006 01	Abox 060 MPI Mounting plate	120	46	970 706 01	DAL 2 Universal outlet cleats	520	253
895 010 01	Abox 100 MPI Mounting plate	120	46	970 716 01	UVA 90 Universal outlet	520	253
895 016 01	Abox 160 MPI Mounting plate	120	46	970 720 01	ROK 1-5 Conduit elbow set	520	251
895 025 01	Abox 250 MPI Mounting plate	120	46	970 725 01	ROK 2-5 Conduit elbow set	520	251
895 035 01	Abox 350 MPI Mounting plate	120	46	970 732 01	ROK 3-5 Conduit elbow set	520	251
920 035 01	HW 035 Flat box	100	282	970 748 01	U 71 KUT-M5 Dome funnel	520	252
920 050 01	HW 050 Receptacle	100	282	971 035 01	U 71 FD Flat box	520	244
920 065 01	HW 065 Branch socket	100	283	971 045 01	U 71 GRD Receptacle	520	244
920 235 01	HW 035 H Receptacle	100	282	971 045 02	U 71 GRD-D Receptacle	520	244
920 250 01	HW 050 H Receptacle	100	283	971 047 01	U 71 KUD Dome box	520	244
920 265 01	HW 065 H Receptacle	100	283	971 065 01	U 71 GVD-2 Branch socket	520	245
920 350 01	HW 050 WD Receptacle	100	282	971 066 01	U 71 DVD-2 Branch socket	520	247
920 365 01	HW 065 WD Branch socket	100	283	971 165 01	U 71 BWD GVD-2-60 Reinforcement box	520	249
923 050 01	HW 050/2 Double Socket	100	284	971 248 01	U 71 KUD-M5 Dome box	520	244

Order-No.	Description	Disc. Group	Page	Order-No.	Description	Disc. Group	Page
971 365 01	U 71 GVD-3 Branch socket	520	245	977 002 01	K15 EK Mounting box	520	254
971 548 01	U 71 DAD Ceiling luminaire junction box	520	246	977 100 01	K0 VD Sealing cap	520	254
971 549 01	U 71 DAD-3 Ceiling luminaire junction box	520	246	977 105 01	K15 VD Sealing cap	520	254
971 745 01	U 71 K GRD Receptacle	520	244	978 100 01	IBT LZA-OE Hole punch	520	266
971 748 01	U 71 KP-M5 Dome	520	246	978 118 01	IBT LZA-18 Hole punch	520	266
971 765 01	U 71 K GVD-2 Branch socket	520	245	978 123 01	IBT LZA-23 Hole punch	520	266
971 766 01	U 71 K DVD-2 Branch socket	520	247	978 814 01	IBT STE-LST/14 Punch set	520	266
971 865 01	U 71 K GVD-3 Branch socket	520	245	978 818 01	IBT STE-LST/18 Punch set	520	266
971 866 01	U 71 K DVD-3 Ceiling junction box	520	247	978 823 01	IBT STE-LST/23 Punch set	520	266
972 760 01	U 71 K GRO Large conduit box	520	245	978 830 01	IBT STE-LST/30 Punch set	520	266
972 770 01	U 71 DGR Large conduit box	520	247	978 839 01	IBT STE-LST/39 Punch set	520	266
972 925 01	U 71 TD-44 Deep box	520	246	978 910 01	IBT STE-LZA/10 Punch set	520	266
972 945 01	U 71 TD-49 Deep box	520	246	978 914 01	IBT STE-LZA/14 Punch set	520	266
972 960 01	U 71 GRO Large conduit box	520	245	978 918 01	IBT STE-LZA/18 Punch set	520	266
973 050 01	U 71 Perilex Receptacle	520	247	978 923 01	IBT STE-LZA/23 Punch set	520	266
973 081 02	U 86 DVD-2 Ceiling junction box	520	250	979 100 01	VD 75 Sealing cap	520	244
973 312 01	U 120 GRO-3 Large conduit box	520	250	979 102 01	U 71 VDF Sealing cap	520	262
973 712 01	U 120 K GRO-2 Large conduit box	520	250	979 103 01	U 86 VDF Sealing cap	520	262
973 713 01	U 120 K GRO-3 Large conduit box	520	250	979 104 01	U 71 VDS Sealing cap	520	262
973 781 01	U 86 K DVD-2 Ceiling junction box	520	250	979 105 01	ES-10 Installation screw	520	267
973 783 01	U 86 K DVD-3 Ceiling junction box	520	250	979 106 01	ES-18 Installation screw	520	267
974 001 01	BS 1 Equipment installation box	520	259	979 107 01	ES-25 Installation screw	520	267
974 002 01	BS 2 Equipment installation box	520	259	979 110 01	GWB Thread bottom	520	246
974 100 01	BS 1 VD Sealing cap	520	259	979 115 01	DH 55 Ceiling hook	520	251
974 102 01	BS 2 VD Sealing cap	520	259	979 116 01	DH 90 Ceiling hook	520	244
974 120 01	BS MBR Assembly bridge	520	259	979 117 01	DH 75-M5 Ceiling hook	520	247
974 130 01	BS ES-30 Installation screw	520	259	979 118 01	DH 65 Ceiling hook	520	262
974 135 01	BS ES-40 Installation screw	520	259	979 119 01	DH 100-M5 Ceiling hook	520	246
974 150 01	BS ES-50 Installation screw	520	259	979 120 01	DH 65-M5 Ceiling hook	520	262
974 431 01	BS 1-BSK Blank base	520	259	979 121 01	DH 115-M5 Ceiling hook	520	250
974 432 01	BS 2-BSK Blank base	520	259	979 122 01	DH 90-M5 Ceiling hook	520	244
975 001 01	K1 EK Mounting box	520	254	979 123 01	DH 135-M5 Ceiling hook	520	262
975 002 01	K2 EK Mounting box	520	255	979 135 01	ABH 1 Spacer	520	265
975 100 01	K1 VD Sealing cap	520	254	979 136 01	KBI 1 Cable tie	520	265
975 102 01	K2 VD Sealing cap	520	255	979 155 01	WED Expansion mandrel	520	266
976 001 01	IBTronic H120-S1 Installation housing	520	269	979 162 01	LST Hand hole punch	520	266
976 002 01	IBTronic H120-S2 Installation housing	520	269	979 205 01	IBT ST Plug	520	261
976 003 01	IBTronic H120-0 Installation housing	520	269	979 210 01	VBN Compound nipple	520	261
976 004 01	IBTronic H120-P Installation housing	520	269	979 212 01	VB 71 Interconnection frame	520	261
976 005 01	IBTronic H120-68 Installation housing	520	269	979 213 01	VB 80/85 Interconnection frame	520	261
976 101 01	IBTronic H120-S1-S2 Installation housing	520	269	979 214 01	VB 90 Interconnection frame	520	261
976 103 01	IBTronic H120-S1-0 Installation housing	520	269	979 215 01	VB 105 Interconnection frame	520	261
976 104 01	IBTronic H120-P-0 Installation housing	520	269	979 218 01	NAH IBTronic H 120 Nailing tool	520	271
976 105 01	IBTronic H120-68-0 Installation housing	520	269	979 230 01	ROS Conduit connector	520	265
976 201 01	IBTronic H120TT-S1 Installation housing	520	270	979 240 01	NAS-AL Spreader nail	520	265
976 202 01	IBTronic H120TT-S2 Installation housing	520	270	979 242 01	NA-AL nail	520	264
976 203 01	IBTronic H120TT-0 Installation housing	520	270	979 243 01	NA-AL/gl nail	520	264
976 204 01	IBTronic H120TT-P Installation housing	520	270	979 245 01	HC Retaining clip	520	265
976 205 01	IBTronic H120TT-68 Installation housing	520	270	979 248 01	KR Adhesive blank	520	265
976 301 01	IBTronic H120TT-S1-0 Installation housing	520	270	979 250 01	HFL Support flange	520	265
976 302 01	IBTronic H120TT-S2-0 Installation housing	520	270	979 260 01	ANSW Weld screw	520	265
976 303 01	IBTronic H120TT-O-0 Installation housing	520	270	979 280 01	HM Double screw	520	265
976 304 01	IBTronic H120TT-P-0 Installation housing	520	270	979 299 01	HM-UNI Magnetic clamp	520	265
976 305 01	IBTronic H120TT-68-0 Installation housing	520	270	979 300 01	MA Magnetic lifter	520	265
976 604 01	IBTronic XL H 185 F Enclosure	520	275	979 330 01	IBT BWA Reinforcement adapter	520	249
976 604 02	IBTronic XL H 185 FE Enclosure	520	275	979 530 01	U 71 BSK-NA Blank base	520	263
976 801 01	IBTronic XL Drillbox Enclosure	520	277	979 530 02	U 71 BSK-2 Blank base exposed concrete	520	263
976 801 02	IBTronic XL Drillbox E Enclosure	520	277	979 531 01	K1 K2 BL Blank strip	520	255
976 804 01	IBTronic XL Drillbox 150 Enclosure	520	279	979 532 01	K0 K15 BL Blank strip	520	254
976 804 02	IBTronic XL Drillbox 150 Enclosure	520	279	979 535 01	STH-STU Support buffer	520	264
977 001 01	K0 EK Mounting box	520	254	979 538 01	U 71 BSK-K Blank base	520	246

General Terms and Conditions

1. For all deliveries

– including deliveries from our agents' stocks – the following terms shall be applied:

- 1.1 the "Warranty regulations of manufacturers of installation devices and installation systems"
- 1.2 "General Conditions for the Supply of Products and Services of the Electrical and Electronics Industry for Commercial Transactions between Businesses" in the version as amended by Zentralverband der Elektrotechnik und Elektronikindustrie (ZVEI) e.V.", the German Electrical and Electronic Manufacturers' Association
- 1.3 in addition, the following paragraphs 2 to 12. We will happily send you the above mentioned norms, delivery terms and clauses, if required. The documents can also be downloaded from our web site (www.spelsberg.de). We here-with reject the conditions of purchase of our customer unless they are explicitly acknowledged by us. Our terms will be acknowledged will be considered the sole binding legal foundation when delivery is taken of objects supplied by. Order confirmations will only be sent if requested expressly.

2. Small orders

for less than 100 euro will not be granted any discount but invoiced gross for net.

3. Sea- proof packing

Will be supplementary invoiced only in case of packing in containers.

4. Delivery freight prepaid

(freight paid, packing included) will be carried out within the territory of Germany for a net order value of more than 1,000 euro. Haulage payable at destination shall be borne by the receiver of the goods.

5. Dispatch

will always be carried out at receiver's risk, even in case of agreed delivery freight prepaid.

6. Suitability and nature of goods

Any indication and information concerning suitability, nature and application our of goods shall not discharge our customer from their own controls and tests. The customer processing our goods shall be assume liability for dispositions prescribed by law, public agencies and electric supply companies.

7. Claims

shall only be acknowledged within 8 days of the receipt of the consignment. On receipt of the goods, the person delivering the goods must confirm any visible damage to goods in transit on the relevant delivery notes.

8. Return of goods

shall be rejected unless we have given our prior acceptance. In case of non-compliance the company /person returning the goods shall assume liability for any costs and disadvantages.

9. Our payment terms

are within 10 days less 3 % cash discount or net within 30 days. If the customer is in arrears of payment, we are entitled to claim interest in the amount of the current base interest. Should the customer's solvency be doubted, in particular in case of payment in arrears, we are entitled, subject to all other claims, to demand payment in advance or guarantees or revoke already granted credit terms.

10. Place of performance

for delivery, payment and other contractual performances of both parties is Schalksmühle. Place of jurisdiction is Lüdenscheid. German law governs the relationship between the contracting parties.

11. Data protection

We are entitled to use data arising from the business relationship with our customers, regardless their origin, within the meaning of the BDSG (the German Federal Data protection Act).



www.spelsberg.com/ak-der-verteiler?pk_campaign=AK%pk_kwd=AK_Com

To the Spelsberg Website

els spelsberg

AK - The distribution board Air®-Technology One for all Models Contact

AK - The distribution board!
With Innovative Air®-Technology

 VDI-certified
  DLC focus test
  Air®-Technology
  One for all
  iF Design Award



Air®-Technology
Innovative - unique!

The Air® ventilation elements avoid Condensate water under preservation of high protection class IP65. Occurring condensate is transported out of the enclosure immediately via air exchanger. The continuous and high air exchange allows the interior air to mix constantly with the environmental air and transports the moisture outward. Even environments with nearly constant humidity and temperature possess air exchange, since the air on the interior of the enclosure warms due to the fittings. The individual components of the ventilation elements mainly consist of the rotating cover (rear side of box) and the filter element integrated on the inside of the box.

Advantages of Air® ventilation elements

- Prevention of condensate water in preservation of high protection class IP65
- High air exchange rate
- 100% pressure compensation
- 100% foreign object protection
- Maintenance-free

Innovative Air®-Technology



More information such as data sheets, the AK trailer, and the AK product manual, are available at:

www.spelsberg.com/ak



