



Catalogue
2020/2021

as®
Schwabe
TechnikProdukte



as - Schwabe

Your partner for professional lighting and electrical products

Quality

as - Schwabe has been manufacturing and distributing goods from the field of electrical engineering for **more than 35 years**, and is synonymous with high-quality **German products**. Our range is specially adapted to the **requirements of heavy-duty construction site applications**, and our products are available from qualified specialist retailers.

Selection

In addition to **cable reels and extensions**, our range also **includes CEE components and power combination units** as well as various **working lamps** and **large-area floodlights**, along with many other electrotechnical products for the construction site. We also offer a comprehensive range of products for the home and garden, as well as camping products.

Service

Our internal and field sales representatives will gladly provide you with comprehensive advice regarding our product range, and can help answer any questions you may have regarding **specific customised productions**. From customer-specific **cable labelling** to precisely tailored **retail shelves** and special **promotional measures** – we are your reliable partner in every respect.

1	Cable reels	8-39
	Metal cable reels, thermoplastic cable reels, Xperts cable reels, extension reels, cable boxes, automatic reels, Mammut reels, empty reels, accessories for cable reels, construction site radios	
2	Personal protection range	40-47
	PRCD-S: Inline RCDs, extensions, cable reels, power combination units PRCD: RCD plugs, extensions, multi socket outlets, cable reels	
3	Extensions	48-61
	Extensions for construction sites, retractable spiral cords, multi socket outlets for outdoor use Extensions for outdoor use, extensions for indoor use	
4	Power cords	62-73
	Power cords with plugs for construction sites, for outdoor use, for indoor use Retractable spiral cords, cable rings and cables sold by metre	
5	Plugs and connectors	74-83
	Shock-proof plugs and connectors, flat plugs, angled plugs, test plugs, 3-way connectors, flanged sockets, surface mounting switches and sockets, plugs and connectors type C	
6	Energy meters and inrush current limiters	84-91
	MIXO energy meters, multi socket outlets with electricity meter, inrush current limiters	
7	Power cubes and suspended distributors	92-97
	With IP20 and IP44 shock-proof socket outlets, compressed air connections, DAT data outlets	
8	CEE 400 V range	98-135
	Plugs and connectors, wall-mounted socket outlets, wall plugs, test plugs, extensions, retractable spiral cords, construction site power combination units, cable bridges, mobile construction site power combination units M-series, multi socket outlets S-series, MIXO adapters, STECKY and STECKY DUO power combination units, FIXO combination units.	
9	Lighting	136-171
	Mobile working lamps, tripod-mounted floodlights, floodlights with motion sensors, battery-operated floodlights, tripods, LICHTFABRIK handlamps and headlamps, circular lamps, wall lamps, halogen floodlights, energy-saving lamps, LED and HQI floodlights for large areas	
10	Measuring devices	172-175
	Infra-red thermometers, moisture meters, Lux meters, decibel meters, hygrometers	
11	Compressed air range	176-181
	Compressed air hoses, compressed air reels, water level tools	
12	Camping/caravan	182-209
	Cable reels, extensions, adapter cords, travel plugs, energy meters, adapters, multi socket outlets, STECKY and STECKY DUO power combination units, plugs and connectors, power supply inlets, flanged sockets, fuses, power cords, caravan adapters	
13	Home and garden	210-232
	Multi socket outlets, multiplugs, FLASH and ALUX multi socket outlets, timers, remote-controlled sockets, ice-stop heating cables, hazard alarms, retractable water hose reels, safety boxes, plug stakes	



Areas of application

Product application areas

The following code is designed to help you work out which products are suitable for which application areas.

We make a distinction between three different areas of use: indoor use, outdoor use and heavy-duty construction site use. Items that are suitable for heavy-duty construction site use can also automatically be used for indoor and outdoor applications.



For use on industrial construction sites

IP44 industrial construction site

For this application area, the materials that are used are subject to particular requirements in addition to those stipulating impermeability to foreign bodies of larger than 1 mm and protection against splash water. Products used on construction sites must be especially break-proof and impact-resistant. Furthermore, only electrical cables with "H07RN-F" or "H07BQ-F" qualities are permitted, in accordance with DGV Information 203-006/BGI 608. "H05RN-F" or "H05BQ-F" is also permissible up to a cable length of 5 m (e.g. cables for lamps).



For outdoor use

IP44 outdoor use

It is recommended to use a protection class of IP44 or higher for outdoor use. The first "4" indicates that the product is protected against the ingress of solid foreign bodies larger than 1 mm.

The second "4" indicates that the product is adequately sealed, meaning that it is protected against splash water on all sides.

Products with the protection class IP44 for outdoor use are usually of equivalent quality to those for use on construction sites. There are, however, some standards and guidelines for products used on construction sites that are not complied with by all products with the protection class IP44 for outdoor use.



For indoor use

IP20 indoor use

Protection class IP20 means that the product is not protected against the ingress of water but is protected against the ingress of solid objects larger than 12.5 mm in diameter. This type of product should therefore only be installed in completely dry locations, such as in dry indoor rooms.





For outdoor use and use on construction sites

BQ

Polyurethane BQ construction site cables

BQ cables have a rubber conductor insulation and are coated with **polyurethane in an orange safety colour**. They are **oil-resistant**, extremely **abrasion-resistant** and permissible for use at temperatures **from -40 to 80°C**. They are particularly well-suited to use on construction sites and in industrial applications, in **dry, damp or wet environments**, in industrial water and outdoors, as well as in agricultural sites and areas with a high risk of fire. They are suitable for **long-term outdoor use**.



RN

Rubber RN power cables

The **black "RN-F" heavy-duty rubber cables** have a rubber conductor insulation and are coated with neoprene rubber. They are **oil, UV and ozone-resistant** and are suitable for temperature ranges of **-30°C to +60°C**. Their excellent mechanical resistance means that they can withstand high levels of stress **in both dry and damp environments and in industrial water**, and they are also suitable for **long-term outdoor use**, e.g. in agricultural applications or on construction sites.



For short-term outdoor use

RR

Rubber RR cables

The sheath and individual conductors of the RR cables are made from flexible natural or synthetic **rubber**. These cables are usually black or red and can be used in indoor areas. They are also suitable for short-term outdoor use.



For indoor use

VV

PVC VV cables

The sheath and individual conductors of the VV cables are made from **PVC plastic**. These versions are standard cables and are suitable for normal loads in indoor use.





IP protection classes

IP protection classes as per DIN EN 60529

The IP protection classes have been defined in connection with the IEC-issued publications 144 and 34-5 in DIN EN 60529 Sheet 1.

The protection class indicates the suitability of electrical operating materials for different ambient conditions.

The IP number indicates the level of protection against **contact, foreign body ingress and water ingress**.

Please note: The IEC (IP) and VDE (P) scope of protection and tests are not always identical.

IP20

Code letters
(International **P**rotection)

First number

Protection against solid foreign bodies e.g. dust

Second number

Protection against water

Number Scope of protection

- 0** No protection against solid foreign bodies and dust. No protection against contact.
- 1** Protection against foreign bodies > 50 mm. Protection against large-area contact with the hand.
- 2** Protection against foreign bodies > 12.5 mm. Protection against contact with the fingers.
- 3** Protection against foreign bodies > 2.5 mm. Protection against contact with tools, wires etc. > 1 mm.
- 4** Protection against foreign bodies > 1 mm. Protection against contact with tools, wires etc.
- 5** Protection against internal dust deposits. Protection against contact with the hand.
- 6** Protection against the ingress of dust. Complete protection against contact.

Number Scope of protection

- 0** No protection against water
- 1** Protection against vertically falling water drops
- 2** Protection against dripping water when tilted
- 3** Protection against spraying water
- 4** Protection against splashing water
- 5** Protection against water jets
- 6** Protection against powerful water jets
- 7** Protection against temporary immersion (water-tight)
- 8** Protection against continuous immersion (water-pressure-tight)

The most common IP protection classes:

IP20: Protected against contact and foreign bodies

IP44: Protected against foreign bodies and splash-proof

IP54: Protected against dust and splash-proof

IP65: Dust-tight and protected against water jets

IP67: Dust-tight and water-tight

IP68: Dust-tight and water-pressure-tight



Meaning of the cable designation (cable quality)

The cable quality can be determined from the exact **cable designation**. The following list provides details regarding the individual components and contains all available variants.

H07RN-F 3G1,5

Cable type

H = Harmonised cable
A = Nationally approved cable

Rated voltage V

03 = 300/300 V
05 = 300/500 V
07 = 450/750 V

Conductor insulation

V = PVC plastic
R = Natural or synthetic rubber
S = Silicone rubber
B = Synthetic rubber

Outer sheath

V = PVC
R = Natural or synthetic rubber
N = Neoprene rubber
J = Fibreglass braid
T = Textile braid
Q = Polyurethane

Conductor type

U = Round, single-wire
R = Round, multi-wire
K = Fine wire for fixed installations
F = Fine wire for movable cables
H = Extra fine wire for movable cables
Y = Ethernet cable

Conductor count

Earth conductor

G = With green-yellow wire
X = Without green-yellow wire

Conductor cross-section in mm²





Customised cables for the construction site

Do you want your **cable reels or extensions** to advertise your company when being used on the construction site?

With our cable labelling service, they can do just that.

We can print the cables for your required products to meet your exact specifications. Whether you want to print the cables with your **company name, address or website** – this all increases the advertising impact on the construction site, which could potentially help you to secure new orders. Printing the cables for construction site use also has the benefit of acting as a **theft deterrent** and therefore protecting your property. It also helps to prevent **confusing** the property of different companies on the construction site.

Take advantage of our cable printing service now.

Here's how it works:

Select the products from the as-Schwabe range that you would like us to label for you. The **minimum purchase amount** is **100 m cable length**, made up of a combination of any lengths and cable types, e.g.:

- Two cable reels each containing 50 m of different cables or
- Ten extensions of different cable types, each 10 m in length

The following cable types can be printed in **sizes up to 5G6**:

H05RR-F

H07RN-F

H07BQ-F



With red and orange cables, black ink is used for printing. With black cables, the printing colour is silver-grey. The inks we use have a high mechanical durability and are largely abrasion-resistant.

**Your advertising
on the cable!**

Order your customised cable printing now
Art no. 61000 (per metre)

Black cables with silver-grey printing ink



Orange or red cables with black printing ink





Your partner to boost your sales



Working together to make the most of your retail space

If you put your trust in as-Schwabe products, we will work with you to create a product range that is perfectly suited to your **customer base**. The **shelving** is tailored to match both the product selection and your **retail space**. Our sales team are on hand to assist you at any time and will support you with the market launch.

Any questions? Just get in touch.

Our sales representatives will be happy to advise you about our comprehensive range of products and services.

as - Schwabe information material

We offer a wealth of information material regarding the products and services in our portfolio, as well as promotional measures to be used in your retail spaces. Our service package is rounded off by **promotional materials, flyers and campaigns** created especially for you.

Do you want to create your own promotional materials with as-Schwabe products? We will happily help you to do this.

Just get in touch.







1

Cable reels for construction sites	10-18
Cable reels for outdoor use	19-20
Cable reels for indoor use	21-22
Cable boxes	23
Automatic rewinding reels	24-27
Mammut cable reels	28-32
Empty reels	32-36
Accessories	37
Construction site radio	38-39

Cable reels

An overview of all details



The **braking and locking of the drum** is ensured by a screw with large star head to ensure excellent grip, even with gloves.



Ergonomic handle consists of **two components** with non-slip surface.

The **ergonomic and non-slip handle** offers an excellent catch, even with gloves.



The **"X" shaped frame body** is reinforced with glass fibres to withstand the most violent impacts.



Rear view



Pads increase the stability of Xperts on soft or uneven ground. They avoid the direct contact of the tubes with the ground and protect from scratches the fragile surfaces on which the cable reel could rest.

The **cable guide** attaches independently on each side to fit Xperts to right-handed or left-handed users.



Especially suitable on construction and assembly sites!



Xperts cable reels

NEW

The **Xperts** series is characterised by its **specially developed X frame**. The combination of functional design and high-quality materials is what really makes this innovation special. The results are extremely robust, stable and weather-resistant cable reels. With **Xperts** cable reels, working on a construction site is simply more convenient. Why not give them a try?

- ✔ **Rust-proof and non-corrosive** frame made from precision steel tubing
- ✔ **Light weight** thanks to the combination of single and double-tube frame
- ✔ Glass-fibre-reinforced components with **very high shatter resistance**
- ✔ Specially developed X-shaped rear housing for **high levels of elongation at break and elastic energy absorption**
- ✔ The curved frame provides very **effective impact absorption** and maximum **vibration reduction**
- ✔ **Very good stability** even on uneven surfaces thanks to the enlarged contact area of the foot rails
- ✔ Carry handle and star-grip brake have been optimised for **use with gloves**
- ✔ **All-weather-resistant:** Can also be used at temperatures down to -25°C
- ✔ Manufacturing process in accordance with **Environmental Management ISO 14001**

You can find the right versions for any application on the following pages.

Thermoplastic cable reels



Technical data

- Reel body made from robust, shatter-proof special plastic
- With stable, shock-absorbing and galvanised single-foot frame with parking brake
- Frame with ergonomically shaped handle and patented cable guide
- With built-in thermo switch
- Tested in accordance with EN 61242, DIN VDE 0620-2-1, DIN EN 50525-2, IEC 60309
- **IP44**: protected against foreign bodies and splash-proof



Construction site cable reels

IP44

Display model



- With shock-proof plug
- With 3 shock-proof socket outlets, splash-proof
- 230 V, 16 A, max. 3500 W

With heavy-duty rubber power cable

RN

Version	Ø mm	PU	EAN	Art. no.
40 m H07RN-F 3G1.5	260	1	4011160111082	11108
40 m H07RN-F 3G1.5 as promotional pallet	260	48	4011160111082	SP11108

Cable box for outdoor use

IP44



- Housing made from special plastic with rotating hand crank
- With shock-proof plug
- With 4 shock-proof socket outlets with child protection and flap lids
- 230 V, 16 A, max. 3500 W

With heavy-duty rubber power cable

RN

Version	PU	EAN	Art. no.
15 m H07RN-F 3G1.5	1	4011160161513	16151

Construction site cable reels

IP44



- With shock-proof plug
- With 3 shock-proof socket outlets, splash-proof
- 230 V, 16 A, max. 3500 W

With heavy-duty rubber power cable

RN

Version	Ø mm	PU	EAN	Art. no.
25 m H07RN-F 3G1.5	230	1/100	4011160101281	10128
40 m H07RN-F 3G1.5	285	1/64	4011160101298	10129
50 m H07RN-F 3G1.5	320	1/48	4011160201257	20125
25 m H07RN-F 3G2.5	285	1/64	4011160101328	10132
33 m H07RN-F 3G2.5	285	1/64	4011160101335	10133
40 m H07RN-F 3G2.5	320	1/48	4011160201240	20124

CEE construction site cable reels

IP44



- With CEE plug 400 V, 16 A, 5-pole
- With 2 shock-proof socket outlets 230 V, splash-proof and 1 CEE socket 400 V, 16 A, 5-pole
- CEE 400 V, 16 A, 5-pole, max. 10000 W

With heavy-duty rubber power cable

RN

Version	Ø mm	PU	EAN	Art. no.
25 m H07RN-F 5G1.5	285	1/60	4011160101557	10155
20 m H07RN-F 5G2.5	285	1/60	4011160101588	10158



Technical data

- Reel body made from robust, shatter-proof special plastic
- With stable, shock-absorbing **X** double-tube frame with star-grip brake
- Frame with ergonomic non-slip 2-component handle and cable guide
- With built-in thermo switch
- Tested in accordance with EN 61242, DIN VDE 0620-2-1, DIN EN 50525-2, IEC 60309



Xperts Thermoplastic cable reels

IP44

NEW



- With shock-proof plug
- With 3 shock-proof socket outlets, splash-proof 
- 230 V, 16 A, max. 3500 W

With heavy-duty rubber power cable

RN

Version	Ø mm	PU	EAN	Art. no.
25 m H07RN-F 3G1.5	285	1/48	4011160226281	22628
40 m H07RN-F 3G1.5	285	1/48	4011160226298	22629
50 m H07RN-F 3G1.5	320	1/48	4011160236259	23625
33 m H07RN-F 3G2.5	285	1/48	4011160226236	22623
40 m H07RN-F 3G2.5	320	1/48	4011160236242	23624

NEW



With heavy-duty polyurethane power cable

BQ

Version	Ø mm	PU	EAN	Art. no.
40 m H07BQ-F 3G1.5	285	1/48	4011160236235	23623
50 m H07BQ-F 3G1.5	320	1/48	4011160236457	23645
40 m H07BQ-F 3G2.5	320	1/48	4011160236440	23644

Xperts CEE thermoplastic cable reels

IP44

NEW



- With CEE plug 400 V, 16 A, 5-pole
- With 2 shock-proof socket outlets 230 V, splash-proof  and 1 CEE socket 400 V, 16 A, 5-pole
- CEE 400 V, 16 A, 5-pole, max. 10000 W

With heavy-duty rubber power cable

RN

Version	Ø mm	PU	EAN	Art. no.
25 m H07RN-F 5G1.5	285	1/40	4011160226557	22655
40 m H07RN-F 5G1.5	320	1/40	4011160236549	23654
20 m H07RN-F 5G2.5	285	1/40	4011160226588	22658
30 m H07RN-F 5G2.5	320	1/40	4011160236532	23653

NEW



With heavy-duty polyurethane power cable

BQ

Version	Ø mm	PU	EAN	Art. no.
40 m H07BQ-F 5G1.5	320	1/40	4011160236648	23664
25 m H07BQ-F 5G2.5	320	1/40	4011160236686	23668
30 m H07BQ-F 5G2.5	320	1/40	4011160236631	23663

IronCoat metal cable reels



Technical data

- Reel body made from hot-dip-galvanised steel plate with special protective insulation
- With ergonomic non-slip 2-component handle and cable guide
- With built-in thermo switch
- Tested in accordance with EN 61242, DIN VDE 0620-2-1, DIN EN 50525-2, IEC 60309
- **IP44**: protected against foreign bodies and splash-proof



IronCoat metal cable reels

IP44



- With shock-absorbing, stable and galvanised single-foot frame with parking brake
- With shock-proof plug
- With 3 shock-proof socket outlets, splash-proof
- 230 V, 16 A, max. 3500 W

With heavy-duty rubber power cable

RN

Version	Ø mm	PU	EAN	Art. no.
25 m H07RN-F 3G1.5	285	1/64	4011160103131	10313
40 m H07RN-F 3G1.5	285	1/64	4011160103148	10314
25 m H07RN-F 3G2.5	285	1/64	4011160103254	10325
33 m H07RN-F 3G2.5	285	1/64	4011160103339	10333

IronCoat Xperts metal cable reels 230 V

IP44

NEW



- With stable, shock-absorbing **X** double-tube frame with star-grip brake
- With shock-proof plug
- With 3 shock-proof socket outlets, splash-proof
- 230 V, 16 A, max. 3500 W

With heavy-duty rubber power cable

RN

Version	Ø mm	PU	EAN	Art. no.
40 m H07RN-F 3G1.5	285	1/48	4011160227295	22729
50 m H07RN-F 3G1.5	320	1/48	4011160233210	23321
25 m H07RN-F 3G2.5	285	1/48	4011160227257	22725
33 m H07RN-F 3G2.5	285	1/48	4011160227233	22723
40 m H07RN-F 3G2.5	320	1/48	4011160233203	23320

NEW



With heavy-duty polyurethane power cable

BQ

Version	Ø mm	PU	EAN	Art. no.
40 m H07BQ-F 3G1.5	285	1/48	4011160233289	23328
50 m H07BQ-F 3G1.5	320	1/48	4011160236464	23646
40 m H07BQ-F 3G2.5	320	1/48	4011160236419	23641

IronCoat Xperts CEE metal cable reel 400 V

IP44

NEW



- With stable, shock-absorbing **X** double-tube frame with star-grip brake
- With CEE plug 400 V, 16 A, 5-pole
- With 2 shock-proof socket outlets 230 V, splash-proof and 1 CEE socket 400 V, 16 A, 5-pole
- CEE 400 V, 16 A, 5-pole, max. 10000 W

With heavy-duty rubber power cable

RN

Version	Ø mm	PU	EAN	Art. no.
25 m H07RN-F 5G2.5	320	1/40	4011160239991	23999

IronCoat metal cable reels

What makes them so special?

IronCoat metal cable reels combine the benefits of a classic steel plate cable reel with improved protection against dangerous touch voltage.

The special patented protective insulation on the side parts provides protection against electric shock caused by defective wiring harnesses when the cable is rolled out. This means that no current can be supplied to large touchable parts of the cable reel from the inside, which in turn helps to ensure protection against serious risks to health.

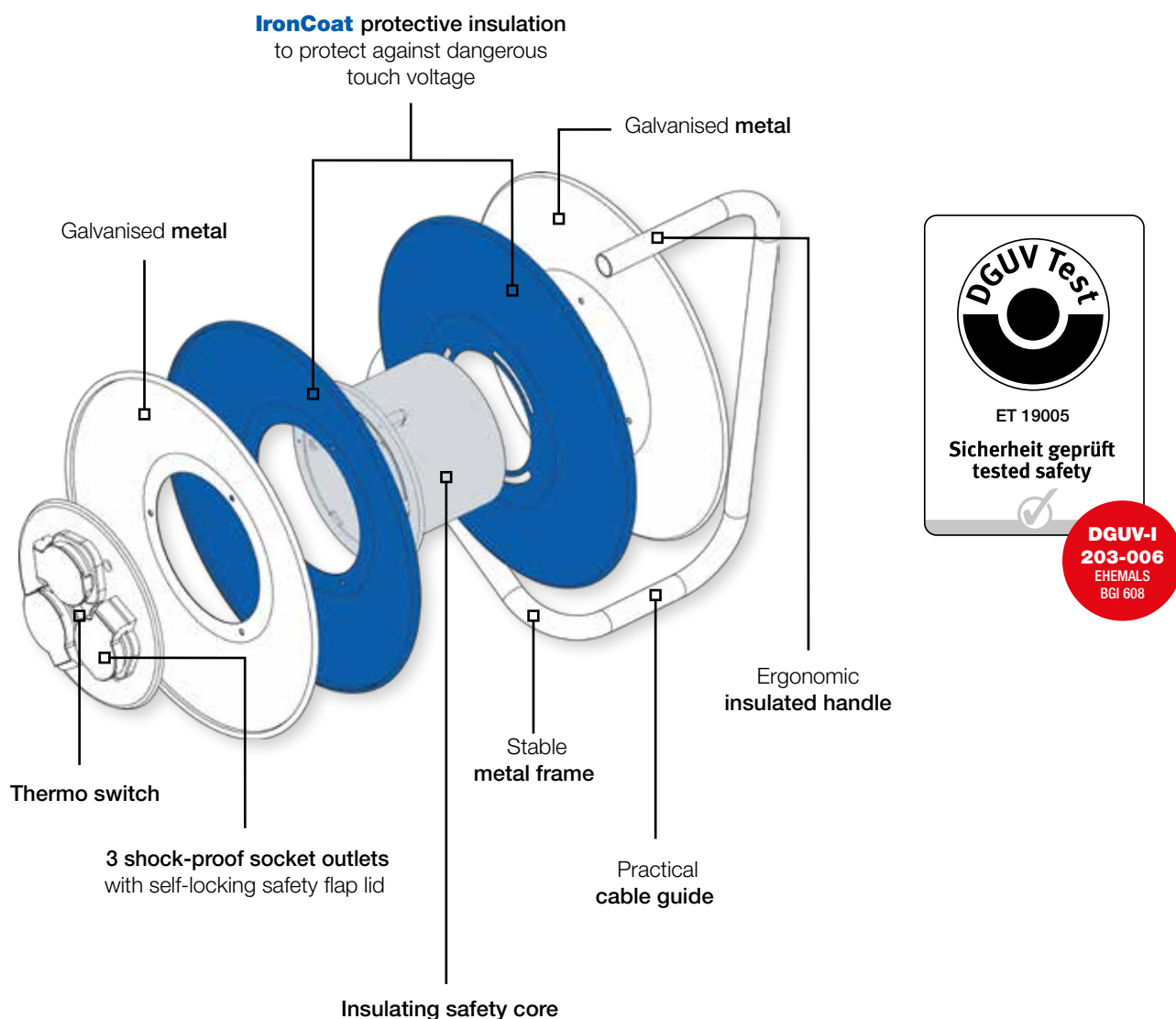

IronCoat metal cable reels have been tested by the **DGVU** (*Deutsche Gesetzliche Unfallversicherung* - German Social Accident Insurance) **and** meet the requirements stipulated by GS-ET 35 / BGI 608. This means that they are ideally suited **to professional use on construction and assembly sites.**



Solid rubber armoured cable reels

Solid rubber armoured cable reels are extremely durable thanks to the special vulcanised hard rubber, making them the ideal choice for the extreme stresses that are present in professional construction site environments. Specially produced series of our reels are even used by the Federal Office for Procurement, and therefore by the German Armed Forces and the German Ministry of Defence.

Solid rubber armoured cable reels



Technical data

- Reel bodies made from extremely durable vulcanised hard rubber material
- Impact-resistant, resistant to oil, grease and petrol, very good insulating properties, unbreakable
- With extremely stable double-tube frame made from 22-mm-thick steel tubing with parking brake
- 2 large crank handles, one of which rotates for easy winding in
- Frame with ergonomic non-slip carry handle and cable guide
- With built-in thermo switch
- With phase monitoring display
- Cable with polyurethane outer sheath for maximum mechanical stress, extremely weather-resistant, highly flexible, tear-resistant, cut-resistant and abrasion-resistant, in orange safety colour
- Tested in accordance with EN 61242, DIN VDE 0620-2-1, DIN EN 50525-2, IEC 60309
- **IP54:** protected against dust and splash-proof



Solid rubber armoured cable reels

IP54



- With SCHUKO Ultra Pro shock-proof plug 230 V
- With 4 shock-proof socket outlets, splash-proof
- 230 V, 16 A, max. 3500 W

With heavy-duty polyurethane power cable

BQ

With shock-proof plug	Ø mm	PU	EAN	Art. no.
50 m H07BQ-F 3G1.5	290	1/32	4011160207426	20742
40 m H07BQ-F 3G2.5	290	1/32	4011160207433	20743



- With CEE plug 400 V, 16 A, 5-pole
- With 2 shock-proof socket outlets 230 V, splash-proof and 1 CEE socket 400 V, 16 A, 5-pole
- CEE 400 V, 16 A, 5-pole, max. 10000 W

With heavy-duty polyurethane power cable

BQ

With CEE plug	Ø mm	PU	EAN	Art. no.
40 m H07BQ-F 5G1.5	290	1/32	4011160207525	20752
30 m H07BQ-F 5G2.5	290	1/32	4011160207532	20753

Extension reels



Technical data

- Reel body made from robust, shatter-proof special plastic with cable reel
- With stable, shock-absorbing and galvanised foot frame with parking brake
- Frame with ergonomically shaped handle and patented cable guide
- With built-in thermo switch
- Tested in accordance with EN 61242, DIN VDE 0620-2-1, DIN EN 50525-2
- **IP44**: protected against foreign bodies and splash-proof



Safety extension reels

IP44



- Connector for shock-proof plugs with lockable safety cover
- With 1.5 m power cord with shock-proof plug
- Cable in red signal colour
- 230 V, 16 A, max. 3500 W

With heavy-duty rubber power cable

RN

Version	Ø mm	PU	EAN	Art. no.
25 m H07RN-F 3G1.5	230	1/100	4011160122323	12232
40 m H07RN-F 3G1.5	285	1/64	4011160122347	12234

Xperts extension reels

IP44

NEW



- Perfect for roofing and scaffolding work
- Solid rubber 3-way connector for shock-proof plugs with rotating safety flap lids
- With 1.5 m power cord with shock-proof plug
- 230 V, 16 A, max. 3500 W

With heavy-duty rubber power cable

RN

Version	Ø mm	PU	EAN	Art. no.
50 m H07RN-F 3G1.5	320	1/48	4011160232466	23246
40 m H07RN-F 3G2.5	320	1/48	4011160232473	23247



Extension reels

What makes them so special?

Extension reels make it possible to work with electrical tools in places where unhindered movement is not possible, such as on roofs or scaffolding. Simply connect the extension reel to the power supply using the 1.5 m power cord, and place the extension reel on a stable surface. Then roll out the extension from the reel body and position the socket at the work location. Tools can then be conveniently plugged in, allowing you to use the entire cable length without having to move the cable reel.

Extension reels for craftsmen



Technical data

- Reel body made from robust, shatter-proof special plastic with cable reel
- With stable, shock-absorbing and galvanised single-foot frame with parking brake
- Frame with ergonomically shaped handle and patented cable guide
- With built-in thermo switch
- Tested in accordance with EN 61242, DIN VDE 0620-2-1, DIN EN 50525-2



Lawnmower extension reels



- Connector for shock-proof plugs with lockable safety cover
- With 1.5 m power cord with shock-proof plug
- Cable in red signal colour
- **IP44**: protected against foreign bodies and splash-proof
- 230 V, 16 A, max. 3500 W

With rubber power cable

RR

Version	Ø mm	PU	EAN	Art. no.
25 m H05RR-F 3G1.5	230	1/100	4011160122361	12236
50 m H05RR-F 3G1.5	285	1/64	4011160122392	12239

Safety extension reels for indoor use



- Connector for shock-proof plug
- With 1.5 m power cord with shock-proof plug
- Cable in red signal colour
- **IP20**: indoor use
- 230 V, 16 A, max. 3500 W

With PVC cable

VV

Version	Ø mm	PU	EAN	Art. no.
25 m H05VV-F 3G1.5	230	1/100	4011160123238	12323
50 m H05VV-F 3G1.5	285	1/64	4011160123252	12325



Cable reels for craftsmen



Technical data

- Tested in accordance with EN 61242, DIN VDE 0620-2-1, DIN EN 50525-2
- **IP44:** protected against foreign bodies and splash-proof



Thermoplastic cable reels

IP44



- Reel body made from robust, shatter-proof special plastic
- With stable, shock-absorbing and galvanised single-foot frame with parking brake
- Frame with ergonomically shaped handle and patented cable guide
- With built-in thermo switch
- With shock-proof plug
- With 3 shock-proof socket outlets, splash-proof
- 230 V, 16 A, max. 3500 W

With rubber power cable

RR

Version	Ø mm	PU	EAN	Art. no.
25 m H05RR-F 3G1.5	230	1/100	4011160101168	10116
50 m H05RR-F 3G1.5	285	1/64	4011160101359	10135

Metal cable reels

IP44



- Reel body made from hot-dip galvanised steel plate
- With stable, shock-absorbing and galvanised single-foot frame with parking brake
- Frame with ergonomically shaped handle and patented cable guide
- With built-in thermo switch
- With shock-proof plug
- With 3 shock-proof socket outlets, splash-proof
- 230 V, 16 A, max. 3500 W

With rubber power cable

RR

Version	Ø mm	PU	EAN	Art. no.
25 m H05RR-F 3G1.5	285	1/64	4011160103179	10317
50 m H05RR-F 3G1.5	285	1/64	4011160103162	10316

Cable reels for craftsmen



Technical data

- With stable, shock-absorbing and galvanised single-foot frame with parking brake
- Frame with ergonomically shaped handle and patented cable guide
- With built-in thermo switch
- Tested in accordance with EN 61242, DIN VDE 0620-2-1, IEC 60309, DIN EN 50525-2
- **IP20**: indoor use



Thermoplastic cable reels

IP20
NEW

- Reel body made from robust, shatter-proof special plastic
- With shock-proof plug
- With 4 shock-proof socket outlets with self-locking protective caps
- 230 V, 16 A, max. 3500 W

With PVC cable

W

Version	Ø mm	PU	EAN	Art. no.
25 m H05VV-F 3G1.5	230	1/100	4011160101182	10118
50 m H05VV-F 3G1.5	285	1/64	4011160101199	10119

With rubber power cable

RR

Version	Ø mm	PU	EAN	Art. no.
25 m H05RR-F 3G1.5	230	1/100	4011160102110	10211
50 m H05RR-F 3G1.5	285	1/64	4011160102127	10212

Metal cable reels

IP20
NEW

- Reel body made from hot-dip galvanised steel plate
- With shock-proof plug
- With 4 shock-proof socket outlets with self-locking protective caps
- 230 V, 16 A, max. 3500 W

With PVC cable

W

Version	Ø mm	PU	EAN	Art. no.
25 m H05VV-F 3G1.5	285	1/100	4011160104145	10414
50 m H05VV-F 3G1.5	285	1/64	4011160103193	10319

With rubber power cable

RR

Version	Ø mm	PU	EAN	Art. no.
25 m H05RR-F 3G1.5	285	1/100	4011160104114	10411
50 m H05RR-F 3G1.5	285	1/64	4011160104121	10412

CEE thermoplastic cable reels

IP20

- Reel body made from robust, shatter-proof special plastic
- With CEE plug 400 V, 16 A, 5-pole
- With 2 shock-proof socket outlets 230 V, splash-proof  and 1 CEE socket 400 V, 16 A, 5-pole
- CEE 400 V, 16 A, 5-pole, max. 10000 W

With PVC cable

W

Version	Ø mm	PU	EAN	Art. no.
20 m H05VV-F 5G1.5 16 A	230	1/75	4011160101458	10145
30 m H05VV-F 5G1.5 16 A	285	1/60	4011160101533	10153

Cable reels for craftsmen



Technical data

- Reel body made from robust, shatter-proof special plastic
- With stable, shock-absorbing and galvanised foot frame
- With built-in thermo switch
- Tested in accordance with EN 61242, DIN VDE 0620-2-1, DIN EN 50525-2
- **IP20**: indoor use



Mini cable reels

IP20



- With shock-proof plug
- With 4 shock-proof socket outlets
- 230 V, 16 A, max. 3500 W

With PVC cable

W

Version	Ø mm	PU	EAN	Art. no.
10 m H05VV-F 3G1.5	180	160	4011160101908	10190
15 m H05VV-F 3G1.5	180	160	4011160101809	10180

Display cable reels

IP20

Display
model



- With shock-proof plug
- With 4 shock-proof socket outlets
- 230 V, 16 A, max. 3500 W

With PVC cable

W

Version	Ø mm	PU	EAN	Art. no.
20 m H05VV-F 3G1.5	230	1	4011160111037	11103
20 m H05VV-F 3G1.5 as promotional pallet	230	60	4011160111037	SP11103
25 m H05VV-F 3G1.5	230	1	4011160111044	11104
25 m H05VV-F 3G1.5 as promotional pallet	230	60	4011160111044	SP11104
40 m H05VV-F 3G1.5	285	1	4011160111020	11102
40 m H05VV-F 3G1.5 as promotional pallet	285	48	4011160111020	SP11102
50 m H05VV-F 3G1.5	285	1	4011160111013	11101
50 m H05VV-F 3G1.5 as promotional pallet	285	48	4011160111013	SP11101



Cable boxes



Technical data

- Cable box made from sturdy, impact-resistant plastic with a modern design
- With practical handle
- Thermo switch included
- For easy winding in and out
- Tested in accordance with: EN 61242, DIN VDE 0620-2-1, DIN EN 50525-2
- **IP20:** indoor use



NEW

- Housing with foldable crank
- With shock-proof angle plug and 4 shock-proof socket outlet with child protection
- 230 V, 16 A, max. 3500 W

With PVC cable

W

Version	Colour	PU	EAN	Art. no.
5 m H05VV-F 3G1.5	Black/grey	1	4011160160806	16080
5 m H05VV-F 3G1.5	Black/blue	1	4011160160813	16081



NEW

- With shock-proof angle plug and 4 shock-proof socket outlet with child protection
- 230 V, 16 A, max. 3500 W

With PVC cable

W

Version	Colour	PU	EAN	Art. no.
10 m H05VV-F 3G1.5	Black/grey	1	4011160160868	16086
10 m H05VV-F 3G1.5	Black/blue	1	4011160160943	16094



- With shock-proof angle plug and 4 shock-proof socket outlet with child protection
- 230 V, 16 A, max. 3500 W

With PVC cable

W

Version	Colour	PU	EAN	Art. no.
15 m H05VV-F 3G1.5	Black/blue	5	4011160160950	16095



- With built-in cable guide for convenient winding in and out
- Rotating hand crank suitable for right or left-handed use
- With shock-proof plug and 4 shock-proof socket outlet with child protection
- 230 V, 16 A, max. 3500 W

With PVC cable

W

Version	Colour	PU	EAN	Art. no.
10 m H05VV-F 3G1.5	Black/blue	1/144	4011160164101	16410
15 m H05VV-F 3G1.5	Black/blue	1/144	4011160164156	16415
25 m H05VV-F 3G1.5	Black/blue	1/144	4011160164231	16423



Art. no.
12639
12640



Art. no.
12641
12642

Anti-twist system

The anti-twist system protects your cables against twisting when winding the cable reel in and out. This is made possible by the socket insert that is detached from the reel body. The reel body twists when the cable is being wound in and out, but the socket insert stays in its original position.

Why not give it a try?

With anti-twist system



Conventional reels



Mobile spring-loaded cable reels



Technical data

- Reel body made from robust, shatter-proof special plastic with anti-twist system
- Spring balancer with latching mechanism for automatic winding in
- Winds in seconds at the touch of a button
- With built-in thermo switch
- With ergonomic handle for easy carrying
- Also suitable for fixed assembly
- Tested in accordance with EN 61242, DIN VDE 0620-2-1, DIN EN 50525-2



ROTOMATIC for outdoor use



Anti-twist system
for easy winding
in and out



- With shock-proof plug
- With 4 shock-proof socket outlets with spring-loaded covers
- **IP44**: protected against foreign bodies and splash-proof
- 230 V, 16 A, max. 3500 W

With heavy-duty rubber power cable

RN

Version	Colour	PU	EAN	Art. no.
10 m H07RN-F 3G1.5	Blue	1	4011160126413	12641
15 m H07RN-F 3G1.5	Blue	1	4011160126420	12642



ROTOMATIC for indoor use



Anti-twist system
for easy winding
in and out



- With shock-proof angle plug
- With 4 shock-proof socket outlets
- **IP20**: indoor use
- 230 V, 16 A, max. 3500 W

With PVC cable

WV

Version	Colour	PU	EAN	Art. no.
10 m H05VV-F 3G1.5	Blue	1	4011160126390	12639
20 m H05VV-F 3G1.5	Blue	1	4011160126406	12640



Automatic cable winder



Technical data

- Reel body made from robust, shatter-proof special plastic: extremely sturdy design
- Can be swivelled 180° on the wall attachment
- With handle for easy carrying
- No more tiresome winding in of the cable. Simply pull gently on the cable and the automatic rewinding mechanism will wind the entire cable into the winder housing.
- The fixed locking mechanism on the cable ensures that the shock-proof connector cannot be pulled into the housing when the cable is being wound in.
- With built-in thermo switch
- Includes heavy-duty dowel/screws for wall attachment



„EASY TO GO“ Simply detach the cable winder from the wall attachment to use on the go.



180° swivelling to the left and right

Automatic cable winder for outdoor use



NEW

- With shock-proof plug and shock-proof connector with protective cap
- Can be swivelled 180° on the wall attachment and with “EASY TO GO” function
- **IP44**: suitable for use in the workshop
- 230 V, 16 A, max. 3500 W

With heavy-duty rubber power cable

RN

With shock-proof plug	Colour	PU	EAN	Art. no.
10 m distribution cable and 1.5 m plug supply line H07RN-F 3G1.5	Grey	1	4011160126468	12646
18 m distribution cable and 2 m plug supply line H07RN-F 3G1.5	Grey	1	4011160126475	12647

Automatic cable winder for indoor use



NEW

- With shock-proof angle plug and shock-proof connector
- Can be swivelled 180° on the wall attachment and with “EASY TO GO” function
- **IP20**: suitable for indoor use
- 230 V, 16 A, max. 2000 W

With PVC cable

WV

With shock-proof angle plug	Colour	PU	EAN	Art. no.
15 m distribution cable and 1.5 m plug supply line H05VV-F 3G1.5	Grey	1	4011160126116	12611
20 m distribution cable and 2 m plug supply line H05VV-F 3G1.5	Grey	1	4011160126451	12645

Automatic CEE cable winder for outdoor use

IP44



- Reel body made from shatter-proof special plastic: extremely sturdy design
- With convenient swivelling wall attachment
- No more tiresome winding in of the cable. Simply pull gently on the cable and the automatic rewinding mechanism will wind the entire cable into the winder housing.
- The fixed locking mechanism on the cable ensures that the connector cannot be pulled into the housing when the cable is being wound in.
- With built-in thermo switch
- Includes heavy-duty dowel/screws for wall attachment
- With CEE plug and CEE connector (400 V, 16 A, max. 11 kW)
- Can be swivelled 180° on the wall attachment
- **IP44:** suitable for use in the workshop
- 400 V, 16 A, 5-pole, max. 10 kW

With heavy-duty rubber power cable

RN

With CEE plug	Colour	PU	EAN	Art. no.
10 m distribution cable and 1 m plug supply line H07RN-F 5G1.5	Grey	1	4011160126482	12648
15 m distribution cable and 1 m plug supply line H07RN-F 5G2.5	Grey	1	4011160126499	12649

Tidied away yet always
to hand on the wall



180° swivelling
to the left and right

You can find the right versions for any application on the following pages.



An overview of all details



Phase monitoring lights



Impact-resistant inspection window IP65



Extra-large foldable winding handle



Trolley with robust brake with locking mechanism



Trolley handle frame with solid folding mechanism



Reel body in direction of travel

Mammut cable reels

What makes them so special?

The extra-large **Mammut** cable reels are the perfect accessory on any construction site. Fitted with up to 80 metres of heavy-duty rubber power cable, they can easily span large distances. The practical trolley means that winding out the cable is super-simple too.

Mammut reels are available in multiple variants with various inputs and outputs. The installed circuit breakers guarantee the necessary safety when working. We guarantee “Made in Germany” quality and the easy procurement of spare parts.

- ✓ **Extremely robust** reel body made from TARMA-Plast rigid plastic
- ✓ Foldable plastic-coated **trolley made from hardened steel in red safety colour**
- ✓ Two large **ergonomic handles** for simple lifting
- ✓ **Foldable handle frame** for easy movement even on uneven surfaces
- ✓ **Stable wheels:** suitable for difficult construction site terrain
- ✓ Large foldable winding handle for **convenient winding in**
- ✓ **Robust brake** with locking mechanism for secure transportation
- ✓ High-quality **VDE-tested** attachment parts
- ✓ Visual **overheating display and function display** for the power supply
- ✓ **IP44:** perfect for use in harsh construction site environments



Permitted for use on construction and assembly sites!



The mobile folding frame makes working on the construction site really easy.

Mammut cable reels 460



Technical data

- Reel body made from extremely robust TARMA-Plast rigid plastic
- Plastic-coated frame with robust parking brake
- Carry/foot frame with ergonomic handles with optional folding mechanism
- Visual overheating display and function display for the power supply
- Tested in accordance with DIN VDE 0620, IEC 60309, DIN EN 50525-2
- **IP44**: protected against foreign bodies and splash-proof



Input 16 A, max. 3.5 kW



Shock-proof plug 230 V, 16 A
with 80 m H07RN-F 3G2.5
Heavy-duty rubber power cable

Output

6x shock-proof socket outlets 230 V, 16 A



Protective device

1x thermo switch, 1-pole



Carry/foot frame

EAN 4011160261008
Art. no. 26100



Folding trolley

EAN 4011160262005
Art. no. 26200

Input 16 A, max. 3.5 kW



CEE plug 230 V, 16 A, 3-pole
with 80 m H07RN-F 3G2.5
Heavy-duty rubber power cable

Output

3x shock-proof socket outlets 230 V, 16 A
3x CEE sockets 230 V, 16 A, 3-pole



Protective device

1x RCD circuit breaker 25 A, 2-pole, 30 mA
4x circuit breaker B 10 A, 1-pole



Carry/foot frame

EAN 4011160261046
Art. no. 26104



Folding trolley

EAN 4011160262043
Art. no. 26204

Mammut cable reels 460

Input 16 A, max. 11 kW



CEE plug 400 V, 16 A, 5-pole
with 40 m H07RN-F 5G2.5
Heavy-duty rubber power cable

Output

3x shock-proof socket outlets 230 V, 16 A
1x CEE socket 230 V, 16 A, 3-pole
3x CEE sockets 400 V, 16 A, 5-pole



Protective device

1x thermo switch, 3-pole



Carry/foot frame

EAN 4011160261015

Art. no. 26101



Folding trolley

EAN 4011160262012

Art. no. 26201

Input 32 A, max. 22 kW



CEE plug 400 V, 32 A, 5-pole
with 30 m H07RN-F 5G4
Heavy-duty rubber power cable

Output

3x shock-proof socket outlets 230 V, 16 A
1x CEE socket 400 V, 16 A, 5-pole
1x CEE socket 400 V, 32 A, 5-pole



Protective device

1x RCD circuit breaker 40 A, 4-pole, 30 mA
1x circuit breaker C 16 A, 1-pole
1x circuit breaker C 16 A, 3-pole



Carry/foot frame

EAN 4011160261022

Art. no. 26102



Folding trolley

EAN 4011160262029

Art. no. 26202

Input 32 A, max. 22 kW



CEE plug 400 V, 32 A, 5-pole
with 40 m H07RN-F 5G6
Heavy-duty rubber power cable

Output

3x shock-proof socket outlets 230 V, 16 A
1x CEE socket 400 V, 16 A, 5-pole
2x CEE sockets 400 V, 32 A, 5-pole



Protective device

1x RCD circuit breaker 40 A, 4-pole, 30 mA
1x circuit breaker C 16 A, 1-pole
1x circuit breaker C 16 A, 3-pole



Carry/foot frame

EAN 4011160261039

Art. no. 26103



Folding trolley

EAN 4011160262036

Art. no. 26203

Input 32 A, max. 22 kW



CEE plug 400 V, 32 A, 5-pole
with 30 m H07RN-F 5G6
Heavy-duty rubber power cable

Output

3x shock-proof socket outlets 230 V, 16 A
2x CEE sockets 400 V, 16 A, 5-pole
1x CEE socket 400 V, 32 A, 5-pole



Protective device

1x RCD circuit breaker 40 A, 4-pole, 30 mA
1x circuit breaker C 16 A, 1-pole
1x circuit breaker C 16 A, 3-pole



Carry/foot frame

EAN 4011160261053

Art. no. 26105



Folding trolley

EAN 4011160262050

Art. no. 26205

Mammut empty reels

Mammut empty reels can be used with an extremely wide range of materials such as ropes, wires, water hoses, cables etc.

Please note: Always observe the legal regulations for maximum cable lengths!

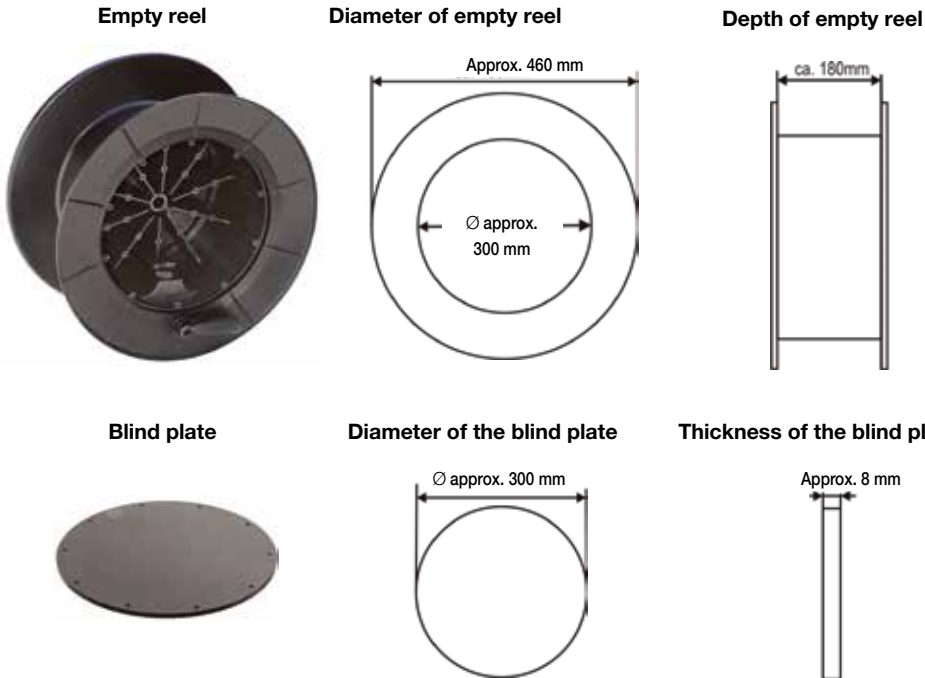

This table indicates how many metres of cable can be wound onto the empty reel, depending on the cable cross-section.

Maximum cable lengths	
Ø mm ²	Max. cable length
3G 1.5	120 m*
3G 2.5	100 m*
5G 1.5	100 m*
5G 2.5	80 m
5G 4	45 m
5G 6	40 m
*Observe the legal regulations!	

Mammut empty reel with carry frame



With blind plate

- Reel body made from extremely robust TARMA-Plast rigid plastic
- Carry/foot frame with ergonomic handle

Version	Ø mm	PU	EAN	Art. no.
Empty reel with blind plate for various cable lengths	460	1	4011160260001	26000

Mammut empty reel with folding trolley



With blind plate

- Reel body made from extremely robust TARMA-Plast rigid plastic
- Plastic-coated trolley with robust parking brake
- With two ergonomic handles and folding mechanism

Version	Ø mm	PU	EAN	Art. no.
Empty reel with blind plate for various cable lengths	460	1	4011160260209	26020



Technical data

- With stable, shock-absorbing **X** double-tube frame with star-grip brake
- With ergonomic non-slip 2-component handle and cable guide
- With built-in thermo switch
- **IP44**: for outdoor use



IronCoat Xperts metal empty reel

IP44



- Reel body made from hot-dip-galvanised steel plate with special IronCoat protective insulation
- With 3 shock-proof socket outlets, splash-proof

Version	Ø mm	PU	EAN	Art. no.
Empty reel for approx. 50 m cable	285	1/48	4011160227288	22728

Xperts plastic empty reels

IP44



- Reel body made from robust, shatter-proof special plastic
- With 3 shock-proof socket outlets, splash-proof

Version	Ø mm	PU	EAN	Art. no.
Empty reel for approx. 40 m cable	285	1/48	4011160226205	22620
Empty reel for approx. 50 m cable	320	1/48	4011160236204	23620

Xperts CEE plastic empty reels

IP44



- Reel body made from robust, shatter-proof special plastic
- With 2 shock-proof socket outlets 230 V, splash-proof and 1 CEE socket 400 V, 16 A, 5-pole

Version	Ø mm	PU	EAN	Art. no.
Empty reel for approx. 25 m cable	285	1/40	4011160226502	22650
Empty reel for approx. 40 m cable	320	1/40	4011160236501	23650

Empty reels



Technical data

- With stable, shock-absorbing and galvanised single-foot frame with parking brake
- With ergonomic non-slip handle
- With built-in thermo switch
- **IP44**: for outdoor use



IronCoat metal empty reel

IP44



- Reel body made from hot-dip-galvanised steel plate with special IronCoat protective insulation
- With 3 shock-proof socket outlets, splash-proof

Version	Ø mm	PU	EAN	Art. no.
Empty reel for approx. 50 m cable	285	1/80	4011160103155	10315

Plastic empty reels

IP44



- Reel body made from robust, shatter-proof special plastic
- With 3 shock-proof socket outlets, splash-proof

Version	Ø mm	PU	EAN	Art. no.
Empty reel for approx. 40 m cable	285	1/80	4011160101205	10120
Empty reel for approx. 50 m cable	320	1/48	4011160201202	20120

CEE thermoplastic empty reel

IP44



- Reel body made from robust, shatter-proof special plastic
- With 2 shock-proof socket outlets 230 V, splash-proof and 1 CEE socket 400 V, 16 A, 5-pole

Version	Ø mm	PU	EAN	Art. no.
Empty reel for approx. 25 m cable	285	1/60	4011160101502	10150

Empty reels for craftsmen



Technical data

- With stable, shock-absorbing and galvanised single-foot frame with parking brake
- With ergonomic non-slip handle
- With built-in thermo switch
- **IP20**: for indoor use



Metal empty reel



NEW



- Reel body made from hot-dip galvanised steel plate
- With 4 shock-proof socket outlets with dust-protection caps

Version	Ø mm	PU	EAN	Art. no.
Empty reel for approx. 50 m cable	285	1/80	4011160104084	10408

Plastic empty reels



NEW



- Reel body made from robust, shatter-proof special plastic
- With 4 shock-proof socket outlets with dust-protection caps

Version	Ø mm	PU	EAN	Art. no.
Empty reel for approx. 25 m cable	230	1/120	4011160102059	10205
Empty reel for approx. 50 m cable	285	1/80	4011160102080	10208

Empty extension reels



- Reel body made from robust, shatter-proof special plastic
- With cable reel and plug storage space

Version	Ø mm	PU	EAN	Art. no.
Empty reel for approx. 50 m cable	285	1/80	4011160122217	12221

Universal reel



The universal reel is perfectly suitable for the storage of:

- Wires
- Cords, ropes, lines
- All types of cables
- Electric fence strands
- And much, much more

Universal reel



- Reel body made from robust, shatter-proof special plastic with cable reel
- With stable, shock-absorbing and galvanised foot frame with parking brake
- Frame with ergonomic handle

Version	Ø mm	PU	EAN	Art. no.
Empty reel	230	1/120	4011160121104	12110
Empty reel	285	1/80	4011160121210	12121

Dimensions of reel body art. no. 12110

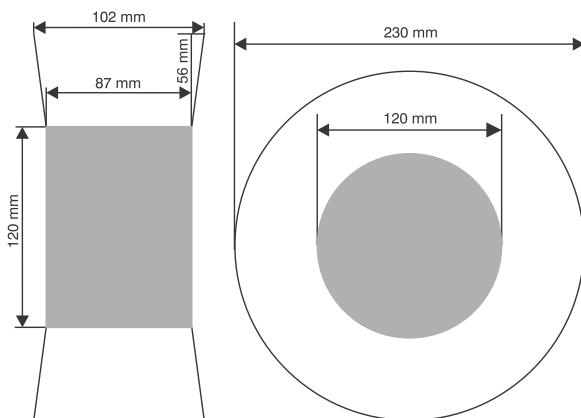

Dimensions of reel body art. no. 12121

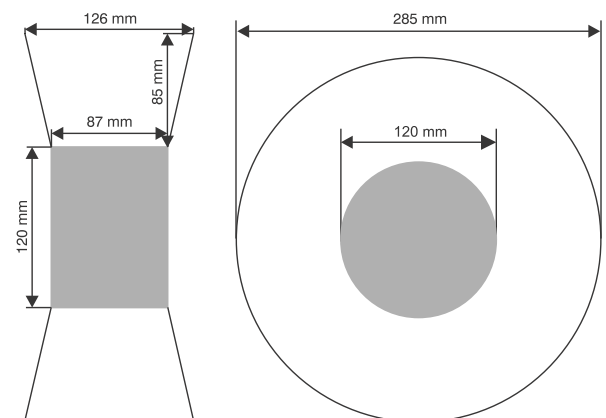

Thermo switches



- For installation in various cable reels
- 56°C +/- 3°C

Fig.	Version	PU	EAN	Art. no.
1	Thermo switch 230 V 1-pole	1	4011160109362	10936
2	Thermo switch 400 V 3-pole	1	4011160109607	10960

Socket inserts

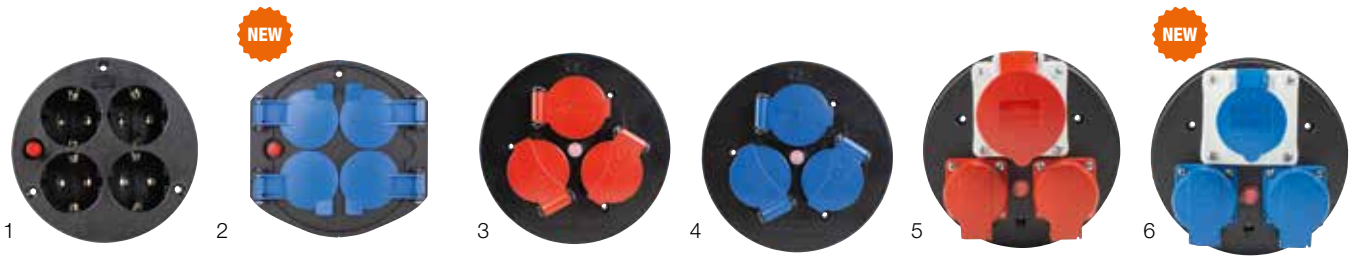

- For installation in various cable reels

Fig.	Version	PU	EAN	Art. no.
1	Socket insert, 4-way IP20 No protective cover With thermo switch	1	4011160105425	10542
2	Socket insert, 4-way IP20 With blue flap lids With thermo switch	1	4011160115424	11542
3	Socket insert, 3-way IP44 With red flap lids With thermo switch	1	4011160105654	10565
4	Socket insert, 3-way IP44 With blue flap lids With thermo switch	1	4011160105661	10566
5	CEE socket insert 400 V, 3-way IP44 With red flap lids With thermo switch	1	4011160109751	10975
6	CEE socket insert 230 V, 3-way IP44 With blue flap lids With thermo switch	1	4011160109768	10976

Construction site radio FM 550

- ✔ Sturdy radio, ideally suited to **outdoor use and on construction sites**
- ✔ With large **illuminated LCD display**
- ✔ Two splash-proof **5 Watt speakers**
- ✔ Inputs: **SD card, AUX, USB**
- ✔ **MP3 and Bluetooth compatible**
- ✔ With automatic or manual **station search function and 20 memory spaces**
- ✔ With **time display and alarm function**
- ✔ Replaceable **li-Ion battery and charger** included in delivery





Construction site radio FM 550

IP44

- Housing with extremely sturdy plastic caging: protected against splash water, dust and impact
- With large LCD display with black background and white text
- With time display and alarm function
- FM radio 88.0-108.0 MHz with 20 memory spaces
- Flexible and robust rubber antenna for FM reception
- Manual search function and automatic station scanning
- Inputs: SD card, AUX, USB (can also be used as charging port: 5 V / 500 mAh)
- Bluetooth CSR 4.0 with 10 m range
- MP3-compatible
- EQ function
- 2x 5 Watt splash-proof speakers
- Includes rechargeable and exchangeable battery pack (li-ion 18650) 7.4 V / 7800 mAh
- Includes charger 110-230 V / 50 Hz - DC 9 V / 2.5 A
- **IP44:** for outdoor use

Version	Colour	PU	EAN	Art. no.
Construction site radio FM 550	Blue/black	1	4011160907500	90750



Easily and effectively protect yourself and your employees against electrical voltage with **PRCD-S personal protection!**

2

PRCD-S range

42-45

PRCD range

46-47

Personal protection range

The following system errors have been detected:

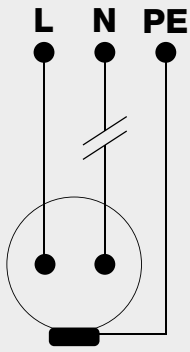

Breakage in N (or L) conductor

Does not switch on.
Full protection.

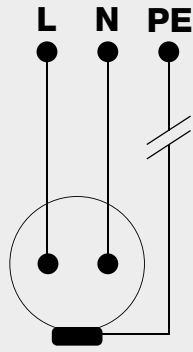

PE conductor breakage

Does not switch on.
Full protection.

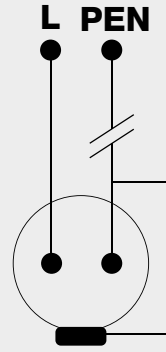

PEN conductor breakage

Does not switch on.
Full protection.

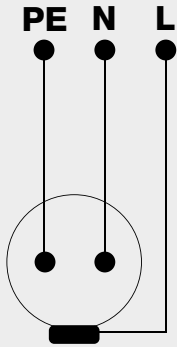

Wiring error

PE and L have been swapped.
Does not switch on.
Full protection.

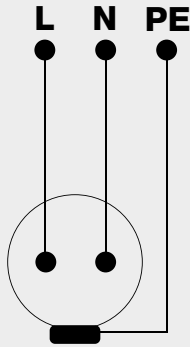

Undervoltage

Does not switch on.
Open circuit in L, N and PE.
Full protection.



Art. no.
45305

A **PRCD-S** provides simple and effective protection against electrical voltage.

The following external errors have been detected:

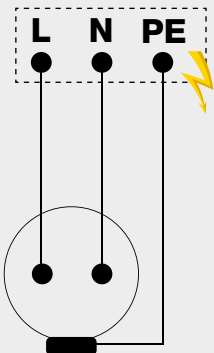

Residual current ≥ 30 mA

Open circuit in L, N and PE.
Full protection.

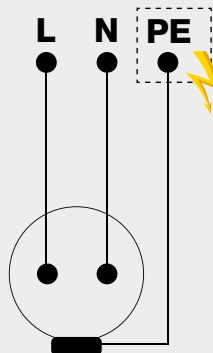

Voltage at PE on switch-on

Does not switch on.
Full protection.

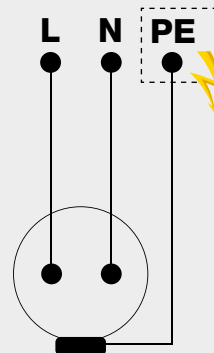

External voltage at PE, e.g. as a result of drilling into a cable

No open circuit in L, N and PE.
The RCD in the external circuit trips. Full protection.

What is a **PRCD-S** ?

A PRCD-S (**P**ortable **R**esidual **C**urrent **D**evice-Safety) is a portable residual current device with earth conductor detection or earth conductor monitoring. These devices are used to provide protection against electrical accidents and are connected between an electrical consumer (e.g. an electrical power tool) and a socket in the same way as an extension.

How does a PRCD-S work?

The power cord wiring is checked when an attempt is made to switch on the PRCD-S.

The PRCD-S can only be switched on if the wiring is in perfect condition.

The connected device can only be put into operation once the PRCD-S has been switched on. This function allows the PRCD-S to prevent accidents caused by faulty electrical installations such as a missing earth conductor. These types of errors are usually only detected through closer examination, making them particularly dangerous.

A PRCD-S only provides this protection if it is switched on **without wearing gloves**, i.e. if it comes into direct contact with the user's skin. This is because the switch-on process involves measuring the earth potential through the user's body.

While the electrical consumer is in operation, the PRCD-S takes on the function of a residual current circuit breaker and **protects the user** from dangerous electrical currents that can be caused by defective electrical operating materials.

The PRCD-S also has an **undervoltage release**. This prevents devices such as angle grinders from switching back on automatically as soon as power is available again after a power failure.



Why are these devices so strongly recommended?

The German institute for research into electrical accidents (Institut zur Erforschung elektrischer Unfälle - BG ETEM) recorded over 3800 electrical accidents in 2018. Many of these could have been avoided thanks to the use of a PRCD-S. In order to increase safety on construction sites in particular, the BG BAU (employer's liability insurance association for the construction industry) has drawn up an **accident prevention regulation** stating that:

“A company must ensure that the electrical systems and operating materials may only be operated in line with the electrotechnical regulations and that any detected defects must be rectified immediately”. In the event of urgent danger, the defective operating materials must not be used”.

In order to comply with this regulation, make sure to always use cables with a built-in PRCD-S on the construction site. This ensures that companies and employees are safe, while also directly investing in health and safety and saving money over the long term.

DGUV Regulation 3
DGUV-I 203-006
DIN VDE 0661

compliant

PRCD-S range

Technical data

- Tested in accordance with DIN VDE 0661:1988-04
- **IP44**: protected against foreign bodies and splash-proof



PRCD-S Inline RCD

IP55



NEW

- Residual current is detected in a split second, and the supply of current interrupted. The PRCD-S therefore provides reliable protection against electric shock and has been approved by the employer's liability insurance association.
- PLEASE NOTE: The switch-on button on the PRCD-S must be actuated using a bare hand in order for the protective function to work. Do not use with gloves!
- Plastic housing with function display and trip test button
- Rated residual current: 30 mA
- Trigger time less than 30 ms
- **IP55**: protected against dust and jet water
- 230 V, 16 A, max. 3500 W

Version	PU	EAN	Art. no.
PRCD-S for independent installation onto the power cord	1	4011160453052	45305

PRCD-S extensions

IP44



NEW

1



NEW

2

- 2x 1.5 m H07BQ-F 3G2.5 heavy-duty polyurethane power cable with shock-proof plug
- With PRCD-S inline RCD (article number 45305)
- 230 V, 16 A, max. 3500 W

Heavy-duty polyurethane power cable

BQ

Fig.	Version	PU	EAN	Art. no.
1	Shock-proof connector with protective cap	1	4011160454585	45458
2	3-way solid rubber shock-proof connector with protective cap	1	4011160454608	45460

PRCD-S range

Technical data

- Tested in accordance with DIN VDE 0661:1988-04
- **IP44:** protected against foreign bodies and splash-proof



PRCD-S Xperts safety cable reel

IP44



- Reel body made from robust, shatterproof special plastic
- With stable, shock-absorbing **Xperts** double-tube frame with star-grip brake
- Frame with ergonomic non-slip 2-component handle and cable guide
- With built-in thermal circuit breaker
- With PRCD-S inline RCD (art. no. 45305)
- With 3 shock-proof socket outlets, splash-proof
- 230 V, 16 A, max. 3500 W

With heavy-duty polyurethane power cable

BQ

Version	Ø mm	PU	EAN	Art. no.
40 m H07BQ-F 3G2.5	285	1/48	4011160238291	23829

PRCD-S power combination unit

IP44



- 2 m H07RN-F **5G2.5** heavy-duty rubber cable and CEE plug 400 V, 16 A
- Robust solid rubber housing
- Dimensions (L x W x H): 400 x 400 x 330 mm
- Weight: 7.9 kg
- Protective device: 1x RCD 40 A, 30 mA, type A
1x earth conductor monitoring module

With heavy-duty rubber cable

RN

Input 16 A , approx. 11 kW	Output	EAN	Art. no.
CEE plug 400 V, 16 A, 5-pole	4x shock-proof socket outlets 230 V, 16 A	4011160454165	45416
	2x CEE sockets 400 V, 16 A, 5-pole		



What is the difference between a PRCD and a PRCD-S?

PRCD

A PRCD is a portable RCD with an electronic residual current release and undervoltage release.

- It detects residual currents that occur when a faulty electrical device is touched, for example, and interrupts the current quickly enough to prevent life-threatening accidents.
- It also has an undervoltage release that prevents secondary accidents in the event of a failure of the mains voltage.

Designed as an inline cable device, the PRCD-S is a portable residual current device with electronic residual current analysis that switches on all poles.

PRCD-S

Additional functions compared to the PRCD:

- Checks the socket to see whether the phase L, the neutral conductor N and the earth conductor PE are present, correctly connected and not mixed up.
- Only allows current to be drawn from a safe socket.
- Checks the earth conductor on switch-on.
- Monitors the earth conductor during operation.
- Does not allow for switch-on if an error is detected.
- Switches off automatically as soon as an error occurs (e.g. earth conductor breakage).
- Does not switch off if external voltage is applied at the earth conductor, e.g. due to drilling into an external cable. Because the PRCD-S does not switch off in this case, the upstream protective device can react and interrupt the circuit.

Employer's liability insurance associations recommend protective distributors and portable RCDs with earth conductor monitoring as the feed point on small construction sites (**PRCD-S**)!

PRCD plugs

IP44/IP66



- Undervoltage release
- Trigger time less than 30 ms
- Reliable protection against dangerous electric shock
- Residual current is detected in a split second, and the supply of current interrupted
- With function display and trip test button and electronic measuring instrument
- 230 V, 16 A, max. 3500 W

Plug	PU	EAN	Art. no.
30 mA RCD plug For fixed connection to the power cord, IP44	1	4011160452093	45209



Inline plug	PU	EAN	Art. no.
30 mA inline RCD plug For connection via a plug, IP44	1	4011160452307	45230

NEW



Inline RCD	PU	EAN	Art. no.
10 mA inline RCD For fixed connection to the power cord, for double-sided cable connection, IP66	1	4011160452215	45221
30 mA inline RCD For fixed connection to the power cord, for double-sided cable connection, IP66	1	4011160452239	45223

PRCD range



Technical data

- Tested in accordance with EN 61242, DIN VDE 0620, VDE 0661, DIN EN 50525-2
- Rated residual current 30 mA
- Undervoltage release
- Trigger time less than 30 ms
- **IP44:** protected against foreign bodies and splash-proof



PRCD extensions

IP44



- With shock-proof plug and shock-proof connector with protective cap
- With function display and trip test button and electronic measuring instrument
- 230 V, 16 A, max. 3500 W

Heavy-duty rubber cable

RN

Version	PU	EAN	Art. no.
2x 1.5 m H07RN-F 3G1.5	1	4011160452222	45222

5-way socket outlet with PRCD plug

IP44



- With safety flap lips and illuminated on/off switch
- Power cord with RCD for reliable protection against residual current
- Very sturdy design
- 230 V, 16 A, max. 3500 W

With heavy-duty rubber cable

RN

Version	PU	EAN	Art. no.
4.5 m H07RN-F 3G1.5	1	4011160386046	38604

Thermoplastic cable reel with PRCD plug

IP44



- Reel body made from robust, shatterproof special plastic
- With stable, shock-absorbing and galvanised single-foot frame with parking brake
- Frame with ergonomically shaped handle and patented cable guide
- With built-in thermal circuit breaker
- With function display and trip test button and electronic measuring instrument
- With PRCD shock-proof plug
- With 3 shock-proof socket outlets, splash-proof 
- 230 V, 16 A, max. 3500 W

With heavy-duty rubber cable

RN

Version	Ø mm	PU	EAN	Art. no.
40 m H07RN-F 3G1.5	285	1/64	4011160108297	10829



3



For use on construction sites **50-57**

For outdoor use **58-59**

For indoor use **58-61**

Extensions

SCHUKO^{ultra} Pro

The perfect connecting device for craftsmen and industrial use



1. EXTREMELY ROBUST
For use under difficult conditions



2. ELAMID INSERT
Made from extremely durable high-performance plastic



3. TWO COMPONENT TECHNOLOGY
Impact-resistant, grippy, non-slip



4. QUICK FASTENING
Secure connection between handle and insulating body by rotating 90°



5. TWO EARTHING SYSTEMS
SCHUKO and French-Belgian standard



6. ANTI-KINK SLEEVE
Protects the cable against breakage



7. VOLTAGE INDICATOR LIGHT
Indicates whether voltage is present



8. FLAP LID
Single-hand operation, stable and self-locking



9. LARGE CONNECTION SPACE
For easy wiring



10. LID LATCHING MECHANISM
Reliable connection of plugs and connectors



11. HARD-WEARING
UV and media-resistant



12. HEAT-RESISTANT
Up to +80°C



13. COLD-RESISTANT
Down to -40°C



14. DUST-PROTECTED
Completely dust-tight as per IP54



15. SPLASH-PROOF
Fully protected against splash water as per IP54

Extensions



Technical data

- Approved for use on construction sites and in agricultural applications
- 230 V, 16 A
- Tested in accordance with DIN VDE 0620-2-1, DIN EN 50525-2
- **IP54**: protected against dust and splash-proof



Extensions with SCHUKOUltra Pro

IP54

- SCHUKOUltra Pro shock-proof plug
- SCHUKOUltra Pro connector with flap lid and voltage indicator light



Heavy-duty rubber cable

RN

Version	Colour	PU	EAN	Art. no.
10 m H07RN-F 3G1.5	Black/red	1	4011160622502	62250
25 m H07RN-F 3G1.5	Black/red	1	4011160622519	62251
10 m H07RN-F 3G2.5	Black/red	1	4011160622526	62252
25 m H07RN-F 3G2.5	Black/red	1	4011160622533	62253
50 m H07RN-F 3G2.5	Black/red	1	4011160622540	62254



Heavy-duty polyurethane power cable

BQ

Version	Colour	PU	EAN	Art. no.
10 m H07BQ-F 3G1.5	Orange/grey	1	4011160622601	62260
25 m H07BQ-F 3G1.5	Orange/grey	1	4011160622618	62261
10 m H07BQ-F 3G2.5	Orange/grey	1	4011160622625	62262
25 m H07BQ-F 3G2.5	Orange/grey	1	4011160622632	62263
50 m H07BQ-F 3G2.5	Orange/grey	1	4011160622649	62264

- SCHUKOUltra Pro shock-proof plug
- SCHUKOUltra Pro 3-way connector with flap lids and voltage indicator light



Heavy-duty rubber cable

RN

Version	Colour	PU	EAN	Art. no.
5 m H07RN-F 3G1.5	Black/red	1	4011160622557	62255
10 m H07RN-F 3G1.5	Black/red	1	4011160622564	62256
5 m H07RN-F 3G2.5	Black/red	1	4011160622571	62257
10 m H07RN-F 3G2.5	Black/red	1	4011160622588	62258



Heavy-duty polyurethane power cable

BQ

Version	Colour	PU	EAN	Art. no.
5 m H07BQ-F 3G1.5	Orange/grey	1	4011160622656	62265
10 m H07BQ-F 3G1.5	Orange/grey	1	4011160622663	62266
5 m H07BQ-F 3G2.5	Orange/grey	1	4011160622670	62267
10 m H07BQ-F 3G2.5	Orange/grey	1	4011160622687	62268



To keep you properly equipped,
we offer products with heavy-duty polyurethane power cables.

Heavy-duty polyurethane power cable

BQ

BQ construction site cables have a rubber conductor insulation and are coated with **polyurethane in an orange safety** colour. They are **oil-resistant**, extremely **abrasion-resistant** and permissible for use at temperatures **from -40 to 80°C**. They are particularly well-suited to use on construction sites and in industrial applications, in **dry, damp or wet environments**, in industrial water and outdoors, as well as in agricultural sites. They are suitable for **long-term outdoor use**.

Extensions



Technical data

- Approved for use on construction sites and in agricultural applications
- Tested in accordance with DIN VDE 0620-2-1, DIN EN 50525-2
- **IP44**: protected against foreign bodies and splash-proof



Construction site armoured cables

IP44

- Shock-proof plug and shock-proof connector with protective cap
- 230 V, 16 A

Heavy-duty polyurethane power cable

BQ



Version	Colour	PU	EAN	Art. no.
5 m H07BQ-F 3G1.5	Orange	1	4011160591051	59105
10 m H07BQ-F 3G1.5	Orange	1	4011160591105	59110
25 m H07BQ-F 3G1.5	Orange	1	4011160591259	59125
50 m H07BQ-F 3G1.5	Orange	1	4011160591501	59150
5 m H07BQ-F 3G2.5	Orange	1	4011160592058	59205
10 m H07BQ-F 3G2.5	Orange	1	4011160592102	59210
25 m H07BQ-F 3G2.5	Orange	1	4011160592256	59225
50 m H07BQ-F 3G2.5	Orange	1	4011160592508	59250

Construction site retractable spiral cords

IP44

- Retractable spiral cord with shock-proof plug and shock-proof connector with protective cap
- Basic length approx. 1 m
- Flexibly elastic up to 5 m
- Retracts again automatically
- Remains highly flexibly even with continual use
- Ideal for lifting platforms, scaffolding and industrial applications: provides the correct cable length every time, precisely at the site where it is needed
- 230 V, 16 A



Heavy-duty polyurethane power cable

BQ

Basic length	Extendable	Colour	PU	EAN	Art. no.
1 m H07BQ-F 3G1.5	Up to 5 m	Orange	1	4011160704130	70413
1 m H07BQ-F 3G2.5	Up to 5 m	Orange	1	4011160704154	70415



- Retractable spiral cord with shock-proof plug and **3-way connector** with protective caps

Heavy-duty polyurethane power cable

BQ

Basic length	Extendable	Colour	PU	EAN	Art. no.
1 m H07BQ-F 3G1.5	Up to 5 m	Orange	1	4011160704147	70414

Extensions



Technical data

- Approved for use on construction sites and in agricultural applications
- Tested in accordance with DIN VDE 0620-2-1, DIN EN 50525-2
- **IP44**: protected against foreign bodies and splash-proof



Rubber extensions for construction sites

IP44

- Approved for use on construction sites and in agricultural applications
- Shock-proof plug and shock-proof connector with protective cap
- 230 V, 16 A

Heavy-duty rubber cable

RN



Version	Colour	PU	EAN	Art. no.
5 m H07RN-F 3G1.5	Black	1	4011160603723	60372
10 m H07RN-F 3G1.5	Black	1	4011160603716	60371
15 m H07RN-F 3G1.5	Black	1	4011160603358	60335
20 m H07RN-F 3G1.5	Black	1	4011160603365	60336
25 m H07RN-F 3G1.5	Black	1	4011160603709	60370
40 m H07RN-F 3G1.5	Black	1	4011160603754	60375
50 m H07RN-F 3G1.5	Black	1	4011160603402	60340
5 m H07RN-F 3G2.5	Black	1	4011160603822	60382
10 m H07RN-F 3G2.5	Black	1	4011160603839	60383
25 m H07RN-F 3G2.5	Black	1	4011160603846	60384
33 m H07RN-F 3G2.5	Black	1	4011160603853	60385
50 m H07RN-F 3G2.5	Black	1	4011160603419	60341

Heavy-duty rubber cable

RN



Version	Colour	PU	EAN	Art. no.
5 m H07RN-F 3G1.5	Red	1	4011160602726	60272
10 m H07RN-F 3G1.5	Red	1	4011160602719	60271
15 m H07RN-F 3G1.5	Red	1	4011160602702	60270
20 m H07RN-F 3G1.5	Red	1	4011160602733	60273
25 m H07RN-F 3G1.5	Red	1	4011160603730	60373
40 m H07RN-F 3G1.5	Red	1	4011160603747	60374

Extensions with multiple socket outlet



Technical data

- Approved for use on construction sites and in agricultural applications
- Tested in accordance with DIN VDE 0620-2-1, DIN EN 50525-2
- **IP44:** protected against foreign bodies and splash-proof



Extensions with 3-way socket outlet

IP44

- Heavy-duty design made from solid rubber
- Approved for use on construction sites and in agricultural applications
- With eyelets for suspension
- With shock-proof plug and rotating, self-locking safety flap lids with hammer symbol 
- 230 V, 16 A



Heavy-duty rubber cable

RN

Version	Colour	PU	EAN	Art. no.
0.3 m H07RN-F 3G1.5	Black	1	4011160604508	60450
4.5 m H07RN-F 3G1.5	Black	1	4011160604546	60454
10 m H07RN-F 3G1.5	Black	1	4011160604560	60456
25 m H07RN-F 3G1.5	Black	1	4011160604584	60458
5 m H07RN-F 3G2.5	Black	1	4011160604454	60445
10 m H07RN-F 3G2.5	Black	1	4011160604461	60446

Extensions with 3-way socket outlet

IP44

Display
model

- Rubber promotional model
- Approved for use on construction sites and in agricultural applications
- With eyelets for suspension
- With shock-proof plug and self-locking safety flap lids
- 230 V, 16 A



Heavy-duty rubber cable

RN

Version	Colour	PU	EAN	Art. no.
4.5 m H07RN-F 3G1.5	Blue/black	1	4011160620584	62058
10 m H07RN-F 3G1.5	Blue/black	1	4011160620591	62059

Suitable for heavy-duty construction site use!



Multi socket outlets for the construction site



Technical data

- Tested in accordance with DIN VDE 0620-2-1, DIN EN 50525-2
- **IP44**: protected against foreign bodies and splash-proof



Socket outlets

IP44



- Approved for use on construction sites and in agricultural applications
- Suitable for wall attachment
- With shock-proof plug and self-locking safety flap lids
- 230 V, 16 A

With rubber power cable

RN

Version		PU	EAN	Art. no.
1.5 m H07RN-F 3G1.5	3-way multi socket outlet	1	4011160386015	38601
1.5 m H07RN-F 3G1.5	6-way multi socket outlet	1	4011160386169	38616

Socket outlets with switch

IP44



- Approved for use on construction sites and in agricultural applications
- Suitable for wall attachment
- With illuminated on/off switch
- With shock-proof plug and self-locking safety flap lids
- 230 V, 16 A

With rubber power cable

RN

Version		PU	EAN	Art. no.
1.5 m H07RN-F 3G1.5	3-way multi socket outlet	1	4011160386039	38603
1.5 m H07RN-F 3G1.5	5-way multi socket outlet	1	4011160386091	38609
4.5 m H07RN-F 3G1.5	5-way multi socket outlet	1	4011160386053	38605
1.5 m H07RN-F 3G1.5	6-way multi socket outlet	1	4011160386060	38606



All models with **shock-proof socket outlets** with safety flap lids and illuminated, splash-proof **on/off switch**. There are also pre-drilled holes for attachment.



No mutual obstruction between the connected plugs thanks to the **45° rotated socket inserts**.

Extensions



Technical data

- Tested in accordance with DIN VDE 0620-2-1, DIN EN 50525-2
- **IP44:** protected against foreign bodies and splash-proof
- **IP20:** indoor use



Rubber extensions for outdoor use



IP44

- Suitable for short-term outdoor use
- Shock-proof plug and shock-proof connector with protective cap
- **IP44:** protected against foreign bodies and splash-proof
- 230 V, 16 A



With rubber power cable

RR

Version	Colour	PU	EAN	Art. no.
5 m H05RR-F 3G1.5	Black	1	4011160603051	60305
10 m H05RR-F 3G1.5	Black	1	4011160603105	60310
15 m H05RR-F 3G1.5	Black	1	4011160603150	60315
25 m H05RR-F 3G1.5	Black	1	4011160603648	60364
50 m H05RR-F 3G1.5	Black	1	4011160603655	60365



With rubber power cable

RR

Version	Colour	PU	EAN	Art. no.
5 m H05RR-F 3G1.5	Red	1	4011160602054	60205
10 m H05RR-F 3G1.5	Red	1	4011160602108	60210
15 m H05RR-F 3G1.5	Red	1	4011160602153	60215
20 m H05RR-F 3G1.5	Red	1	4011160602627	60262
25 m H05RR-F 3G1.5	Red	1	4011160602641	60264
50 m H05RR-F 3G1.5	Red	1	4011160602658	60265

PVC extensions for indoor use



IP20

- Suitable for indoor use
- Shock-proof plug and shock-proof connector
- **IP20:** indoor use
- 230 V, 16 A



PVC cable

VV

Version	Colour	PU	EAN	Art. no.
10 m H05VV-F 3G1.5	Red	1	4011160510137	51013
15 m H05VV-F 3G1.5	Red	1	4011160511530	51153
20 m H05VV-F 3G1.5	Red	1	4011160511608	51160
25 m H05VV-F 3G1.5	Red	1	4011160603617	60361
50 m H05VV-F 3G1.5	Red	1	4011160603594	60359

Extensions with multiple socket outlet



Technical data

- Tested in accordance with DIN VDE 0620-2-1, DIN EN 50525-2

Extensions with 4-way socket outlet



- Robust design for outdoor use
- With eyelets for suspension
- With shock-proof plug and self-locking safety flap lids
- **IP44:** protected against foreign bodies and splash-proof
- 230 V, 16 A

Heavy-duty rubber cable

RN

Version		PU	EAN	Art. no.
5 m H07RN-F 3G1.5	For long-term outdoor use	1	4011160606731	60673
10 m H07RN-F 3G1.5	For long-term outdoor use	1	4011160606717	60671

With rubber power cable

RR

Version		PU	EAN	Art. no.
10 m H05RR-F 3G1.5	For short-term outdoor use	1	4011160606724	60672

Extension with 4-way socket outlet



- For indoor use
- With eyelets for suspension and anti-kink sleeve
- With shock-proof plug and self-locking safety flap lids
- In red safety colour
- **IP20:** indoor use
- 230 V, 16 A

PVC cable

WV

Version	Colour	PU	EAN	Art. no.
10 m H05VV-F 3G1.5	Red	1	4011160606120	60612

Extensions for indoor use



Technical data

- Tested in accordance with DIN VDE 0620-2-1, DIN EN 50525-2
- **IP20:** indoor use



Retractable extensions with angled plug



IP20



- Suitable for indoor use
- With shock-proof angle plug and shock-proof connect
- 230 V, 16 A

PVC cable

W

Basic length	Extendable	Colour	PU	EAN	Art. no.
1 m H05VV-F 3G1.5	Up to 2.5 m	White	5	4011160704123	70412
1 m H05VV-F 3G1.5	Up to 2.5 m	Black	5	4011160704109	70410
2 m H05VV-F 3G1.5	Up to 4 m	White	5	4011160704260	70426
2 m H05VV-F 3G1.5	Up to 4 m	Black	5	4011160704253	70425



Extensions with angled plug



IP20

- Suitable for indoor use
- With shock-proof angle plug and shock-proof connect
- 230 V, 16 A

PVC cable

W

Version	Colour	PU	EAN	Art. no.
2 m H05VV-F 3G1.5	White	10	4011160502019	50201
2 m H05VV-F 3G1.5	Black	10	4011160502026	50202
3 m H05VV-F 3G1.5	White	10	4011160503115	50311
3 m H05VV-F 3G1.5	Black	10	4011160503122	50312
5 m H05VV-F 3G1.5	White	10	4011160505119	50511
5 m H05VV-F 3G1.5	Black	10	4011160505126	50512
10 m H05VV-F 3G1.5	White	5	4011160510113	51011
10 m H05VV-F 3G1.5	Black	5	4011160510120	51012
25 m H05VV-F 3G1.5	Black	5	4011160603624	60362



Extensions for indoor use



Technical data

- Tested in accordance with DIN VDE 0620-2-1, DIN EN 50525-2
- **IP20:** indoor use



Extensions with flat plug



IP20



NEW



- Suitable for indoor use
- With shock-proof flat plug and shock-proof connector
- With foldable bracket for easy removal from the socket
- Extremely flat fit, protrudes from the socket by just 7 mm
- 230 V, 16 A, max. approx. 3.5 kW

PVC cable

w

Version	Colour	PU	EAN	Art. no.
2 m H05VV-F 3G1.5	White	10	4011160502118	50211
2 m H05VV-F 3G1.5	Black	10	4011160502125	50212
5 m H05VV-F 3G1.5	White	10	4011160505218	50521
5 m H05VV-F 3G1.5	Black	10	4011160505225	50522
10 m H05VV-F 3G1.5	White	10	4011160510212	51021
10 m H05VV-F 3G1.5	Black	10	4011160510229	51022



Extremely flat plug fit; plug protrudes from the socket by just 7 mm.



Foldable bracket for easy removal from the socket.

Euro extensions

IP20

- Suitable for indoor use
- With Euro flat plug and Euro connector
- 230 V, 2.5 A



PVC cable

w

Version	Colour	PU	EAN	Art. no.
2 m H03VVH2-F 2x0,75	White	10	4011160501012	50101
2 m H03VVH2-F 2x0,75	Black	10	4011160501029	50102
3 m H03VVH2-F 2x0,75	White	10	4011160501319	50131
3 m H03VVH2-F 2x0,75	Black	10	4011160501326	50132
5 m H03VVH2-F 2x0,75	White	10	4011160501517	50151
5 m H03VVH2-F 2x0,75	Black	10	4011160501524	50152



Information on custom-made cords or extensions can be found on page 70.

4

Power cords

64-71

Cable rings/sold by metre

72-73

Power cords

Power cords



Technical data

- Tested in accordance with DIN VDE 0620-2-1, IEC 60309, DIN EN 50525-2
- **IP44**: protected against foreign bodies and splash-proof



Drill power cords

IP44



- Open cable end: approx. 50 mm stripped with wire-end ferrules
- Plug end: with 2-pin plug
- 230 V, 16 A

With rubber power cable

RN

Version	Colour	PU	EAN	Art. no.
3 m H05RN-F 2x1.0	Black	10	4011160705328	70532
5 m H05RN-F 2x1.0	Black	10	4011160705304	70530

Heavy-duty rubber cable

RN

Version	Colour	PU	EAN	Art. no.
5 m H07RN-F 2x1.0	Black	10	4011160705526	70552
3 m H07RN-F 2x1.5	Black	5	4011160705564	70556
5 m H07RN-F 2x1.5	Black	5	4011160705588	70558

Rubber power cords

IP44



- Open cable end: approx. 30 mm stripped with wire-end ferrules
- Plug end: with splash-proof shock-proof plug
- 230 V, 16 A

With rubber power cable

RN

Version	Colour	PU	EAN	Art. no.
3 m H05RN-F 3G1.0	Black	10	4011160603761	60376

Heavy-duty rubber cable

RN

Version	Colour	PU	EAN	Art. no.
4.5 m H07RN-F 3G1.5	Black	10	4011160603792	60379
10 m H07RN-F 3G1.5	Black	1	4011160709104	70910
15 m H07RN-F 3G1.5	Black	1	4011160709128	70912

CEE power cords

IP44



- Open cable end: approx. 50 mm stripped with wire-end ferrules
- Plug end: with high-quality CEE plug
- 400 V, 16 A or 400 V, 32 A

Heavy-duty rubber cable

RN

Version	Colour	PU	EAN	Art. no.
3 m H07RN-F 5G1.5 16 A	Black/red	1	4011160709777	70977
5 m H07RN-F 5G6 32 A	Black/red	1	4011160709708	70970

Power cords



Technical data

- Tested in accordance with DIN VDE 0620-2-1, IEC 60309, DIN EN 50525-2
- **IP44:** protected against foreign bodies and splash-proof



Construction site power cords

IP44



- Open cable end: approx. 30 mm stripped with wire-end ferrules
- Plug end: with splash-proof 2-pin plug (Fig. 1) or shock-proof plug (Fig. 2)
- 230 V, 16 A

Heavy-duty polyurethane power cable

BQ

Fig.	Version	Safety colour	PU	EAN	Art. no.
1	3 m H05BQ-F 2x1.0	Orange	1	4011160709111	70911
1	5 m H05BQ-F 2x1.0	Orange	1	4011160709135	70913
1	3 m H07BQ-F 2x1.5	Orange	1	4011160709142	70914
1	5 m H07BQ-F 2x1.5	Orange	1	4011160709173	70917
2	3 m H07BQ-F 3G1.0	Orange	1	4011160709180	70918
2	5 m H07BQ-F 3G1.0	Orange	1	4011160709197	70919
2	3 m H07BQ-F 3G1.5	Orange	1	4011160709098	70909
2	5 m H07BQ-F 3G1.5	Orange	1	4011160709081	70908

Retractable spiral cords

IP44

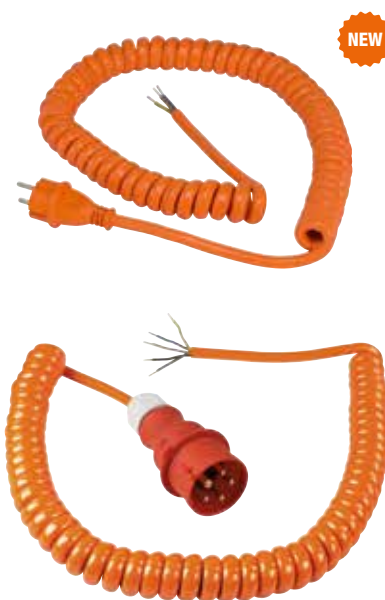

- Open cable end: approx. 50 mm stripped with wire-end ferrules
- Plug end: with shock-proof plug
- Retractable polyurethane spiral cord
- Flexibly elastic
- Retracts again automatically
- 230 V, 16 A or CEE 400 V, 16 A

Heavy-duty polyurethane power cable

BQ

With shock-proof plug 230 V, 16 A		Colour	PU	EAN	Art. no.
Basic length 1 m	H07BQ-F 3G1.5 Elastic up to 5 m	Orange	10	4011160704307	70430
With CEE plug 400 V, 16 A		Colour	PU	EAN	Art. no.
Basic length 1 m	H07BQ-F 5G1.5 Elastic up to 5 m	Orange	10	4011160704314	70431
Basic length 1 m	H07BQ-F 5G2.5 Elastic up to 5 m	Orange	10	4011160704321	70432



Heavy-duty polyurethane power cable

BQ

BQ cables have a rubber conductor insulation and are coated with **polyurethane in an orange safety colour**. They are **oil-resistant**, extremely **abrasion-resistant** and permissible for use at temperatures **from -40 to 80°C**. They are particularly well-suited to use on construction sites and in industrial applications, in **dry, damp or wet environments**, in industrial water and outdoors, as well as in agricultural sites and areas with a high risk of fire. They are suitable for **long-term outdoor use**.

Power cords



Technical data

- Tested in accordance with DIN VDE 0620-2-1, DIN EN 50525-2
- **IP20**: for indoor use



Drill power cord

IP20



- Open cable end: approx. 50 mm stripped with wire-end ferrules
- Plug end: with 2-pin plug
- 230 V, 16 A

PVC cable

W

Version	Colour	PU	EAN	Art. no.
3 m H05VV-F 2x1.0	Black	10	4011160705229	70522

Euro power cords

IP20



- Open cable end: approx. 30 mm stripped with wire-end ferrules
- Plug end: with Euro flat plug
- 230 V, 2.5 A

PVC cable

W

Version	Colour	PU	EAN	Art. no.
1.5 m H03VVH2-F 2x0.75	White	10	4011160706417	70641
1.5 m H03VVH2-F 2x0.75	Black	10	4011160706424	70642
3 m H03VVH2-F 2x0.75	White	10	4011160706516	70651
3 m H03VVH2-F 2x0.75	Black	10	4011160706523	70652



Euro power cords with inline switch

IP20



- Open cable end: approx. 30 mm stripped with wire-end ferrules
- Plug end: with Euro flat plug
- With inline switch, switches on 1 pole
- Cable length between plug and switch: approx. 2.3 m
- Cable length between switch and wire-end ferrules: approx. 0.7 m
- 230 V, 2.5 A

PVC cable

W

Version	Colour	PU	EAN	Art. no.
3 m H03VVH2-F 2x0.75	White	10	4011160706318	70631
3 m H03VVH2-F 2x0.75	Black	10	4011160706325	70632





Technical data

- Tested in accordance with DIN VDE 0620-2-1, DIN EN 50525-2
- **IP20**: for indoor use



Power cords with shock-proof angle plug

IP20



- Open cable end: approx. 30 mm stripped with wire-end ferrules
- Plug end: with shock-proof angle plug
- 230 V, 10 A

PVC cable

W

Version	Colour	PU	EAN	Art. no.
3 m H05VV-F 3G1.0	White	10	4011160708336	70833
3 m H05VV-F 3G1.0	Black	10	4011160708329	70832
10 m H05VV-F 3G1.0	White	10	4011160708008	70800
10 m H05VV-F 3G1.0	Black	10	4011160708022	70802

Retractable spiral cords

IP20

NEW



- Open cable end: approx. 60 mm stripped with wire-end ferrules
- Plug end: with shock-proof angle plug
- Retracts again automatically
- PVC cable H05VV-F 3G1.5
- 230 V, 16 A

PVC cable

W

Version	Colour	PU	EAN	Art. no.
Basic length 1 m Elastic up to 2.5 m	White	10	4011160704239	70423
Basic length 1 m Elastic up to 2.5 m	Black	10	4011160704246	70424
Basic length 2 m Elastic up to 4 m	White	10	4011160704277	70427
Basic length 2 m Elastic up to 4 m	Black	10	4011160704284	70428

Additional versions on request.
We will be happy to help you with the selection of your cables.

Power cords



Technical data

- Tested in accordance with DIN VDE 0620-2-1, DIN EN 50525-2, DIN EN 60320, DIN EN 60309
- **IP20**: for indoor use



Power extension type C13 (70°C)

IP20

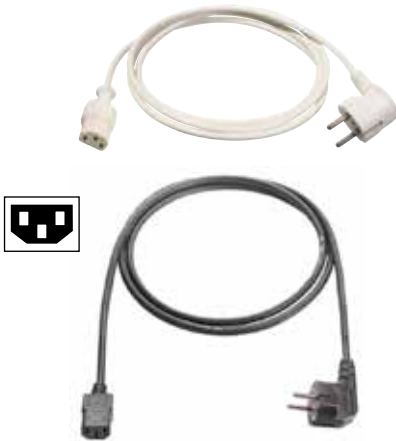

- With low-heat device socket type C13
- Plug end: with shock-proof angle plug
- 230 V, 10 A

PVC cable

W

Version	Colour	PU	EAN	Art. no.
2 m H05VV-F 3G0.75	White	5	4011160708701	70870
2 m H05VV-F 3G0.75	Black	5	4011160708718	70871

Power extension type C13/C14 (70°C)

IP20



- With small appliance socket type C13
- Plug end: with low-heat device plug type C14
- 230 V, 10 A

PVC cable

W

Version	Colour	PU	EAN	Art. no.
2 m H05VV-F 3G0.75	Black	5	4011160708787	70878

Power cords



Technical data

- Tested in accordance with DIN EN 50525-2
- **IP20**: for indoor use

Power extension type C15 (120°C)

IP20



- With medium-heat socket type C15
- Plug end: with shock-proof straight plug
- 230 V, 10 A

With rubber power cable

RR

Version	Colour	PU	EAN	Art. no.
2 m H05RR-F 3G1.0	Black	5	4011160708732	70873

Power extension type C15A (155°C)

IP20



- With high-heat socket type C15A
- Plug end: with shock-proof straight plug
- 230 V, 10 A

With rubber power cable

RN

Version	Colour	PU	EAN	Art. no.
2 m H05RN-F 3G1.0	Black	5	4011160708749	70874



Custom-made products

For trade and industry

We can respond to your requirements quickly and with a high level of flexibility, and can create **customised products** and **solutions**. Our team are always on hand to answer any questions you may have with regard to customised products, assembly and **production**. Our production facilities are certified to **ISO 9001**. We will gladly work with you to develop a professional solution. **Just get in touch.**

We can produce the following items for you:

- Standardised power cables and device power cords
- Country-specific cable variants
- Customised cords
- Solutions with PRCD and RCD's
- Various customised strain relief and bushing solutions for the appliance connection
- Cables with connector systems and wire-end ferrules in line with your specifications
- We make these items at our own production facilities in line with your drawings

Power cords



Technical data

- Tested in accordance with DIN EN 50525-2
- **IP20**: for indoor use



Iron power cord

IP20



- Open cable end: approx. 30 mm stripped with wire-end ferrules
- Plug end: with shock-proof angle plug
- Textile fabric outer sheath
- 230 V, 10 A

Textile cable

RT

Version	Colour	PU	EAN	Art. no.
3 m H03RT-F 3G1.0	Black/white	5	4011160872020	87202

Stove power cord

IP20



- Two open cable ends: approx. 50 mm stripped with wire-end ferrules
- 400 V, 16 A

PVC cable

W

Version	Colour	PU	EAN	Art. no.
1.5 m H05VV-F 5G1.5	White	10	4011160708657	70865
3 m H05VV-F 5G1.5	White	10	4011160708664	70866
1.5 m H05VV-F 5G2.5	White	10	4011160708671	70867
3 m H05VV-F 5G2.5	White	10	4011160708688	70868

Cable rings



Technical data

- Cable with polyurethane outer sheath for maximum mechanical stress
- In orange safety colour
- For the connection of commercial appliances e.g. machines and transportable engines
- EU product
- Tested in accordance with VDE 0285-525-2-21



Construction site cable, 50 m cable rings

- Pre-assembled rings with 50 m cable



Heavy-duty polyurethane power cable

BQ

Version	PU	EAN	Art. no.
50 m H07BQ-F 3G1.5	1	4011160593505	59350
50 m H07BQ-F 3G2.5	1	4011160594410	59441
50 m H07BQ-F 5G1.5	1	4011160594427	59442
50 m H07BQ-F 5G2.5	1	4011160596315	59631
50 m H07BQ-F 5G4	1	4011160594458	59445
50 m H07BQ-F 5G6	1	4011160594472	59447

Construction site cable, sold by metre

- Available by the metre (running metre) in your required length



Heavy-duty polyurethane power cable

BQ

Version	PU	EAN	Art. no.
Running metre H07BQ-F 3G1.5	1	4011160100444	10044
Running metre H07BQ-F 3G2.5	1	4011160100468	10046
Running metre H07BQ-F 5G1.5	1	4011160100499	10049
Running metre H07BQ-F 5G2.5	1	4011160100512	10051
Running metre H07BQ-F 5G4	1	4011160594441	59444
Running metre H07BQ-F 5G6	1	4011160594465	59446



Heavy-duty polyurethane power cable

BQ

BQ cables have a rubber conductor insulation and are coated with **polyurethane in an orange safety colour**. They are **oil-resistant**, extremely **abrasion-resistant** and permissible for use at temperatures **from -40 to 80°C**. They are particularly well-suited to use on construction sites and in industrial applications, in **dry, damp or wet environments**, in industrial water and outdoors, as well as in agricultural sites and areas with a high risk of fire. They are suitable for **long-term outdoor use**.



Technical data

- RN cable with runner conductor insulation and coated in black neoprene rubber for high mechanical stress
- For the connection of commercial appliances e.g. machines and transportable engines
- Tested in accordance with VDE 0285-525-2-21



Heavy-duty rubber cable, 50 m cable rings



- Pre-assembled rings with 50 m cable

Heavy-duty rubber cable

RN

Version	PU	EAN	Art. no.
50 m H07RN-F 3G1.5	1	4011160100178	10017
50 m H07RN-F 3G2.5	1	4011160100208	10020
50 m H07RN-F 5G1.5	1	4011160100277	10027
50 m H07RN-F 5G2.5	1	4011160100321	10032
50 m H07RN-F 5G4	1	4011160100369	10036
50 m H07RN-F 5G6	1	4011160100420	10042
50 m H07RN-F 5G10	1	4011160100475	10047
50 m H07RN-F 5G16	1	4011160100536	10053

Heavy-duty rubber cable, sold by metre



- Available by the metre (running metre) in your required length

Heavy-duty rubber cable

RN

Version	PU	EAN	Art. no.
Running metre H07RN-F 3G1.5	1	4011160100130	10013
Running metre H07RN-F 3G2.5	1	4011160100185	10018
Running metre H07RN-F 4x16	1	4011160100871	10087
Running metre H07RN-F 4x25	1	4011160100918	10091
Running metre H07RN-F 4x35	1	4011160100895	10089
Running metre H07RN-F 5G1.5	1	4011160100253	10025
Running metre H07RN-F 5G2.5	1	4011160100307	10030
Running metre H07RN-F 5G4	1	4011160100345	10034
Running metre H07RN-F 5G6	1	4011160100406	10040
Running metre H07RN-F 5G10	1	4011160100451	10045
Running metre H07RN-F 5G16	1	4011160100505	10050
Running metre H07RN-F 5G25	1	4011160100758	10075
Running metre H07RN-F 5G35	1	4011160100765	10076



5



Shock-proof plugs and connectors	76-79
Test plugs for sockets	80
Multiple socket outlets	81
Surface mounting switches and sockets	82
Plugs and connectors type C	83

Plugs and connectors

SCHUKO^{ultra} Pro

The perfect connecting device for craftsmen and industrial use



1. EXTREMELY ROBUST
For use under difficult conditions



2. ELAMID INSERT
Made from extremely durable high-performance plastic



3. TWO COMPONENT TECHNOLOGY
Impact-resistant, grippy, non-slip



4. QUICK FASTENING
Secure connection between handle and insulating body by rotating 90°



5. TWO EARTHING SYSTEMS
SCHUKO and French-Belgian standard



6. ANTI-KINK SLEEVE
Protects the cable against breakage



7. VOLTAGE INDICATOR LIGHT
Indicates whether voltage is present



8. FLAP LID
Single-hand operation, stable and self-locking



9. LARGE CONNECTION SPACE
For easy wiring



10. LID LATCHING MECHANISM
Reliable connection of plugs and connectors



11. HARD-WEARING
UV and media-resistant



12. HEAT-RESISTANT
Up to +80°C



13. COLD-RESISTANT
Down to -40°C



14. DUST-PROTECTED
Completely dust-tight as per IP54



15. SPLASH-PROOF
Fully protected against splash water as per IP54

Shock-proof plugs and connectors



Technical data

- Tested in accordance with DIN VDE 0620-2-1

SCHUKOultra Pro plugs and connectors

IP54

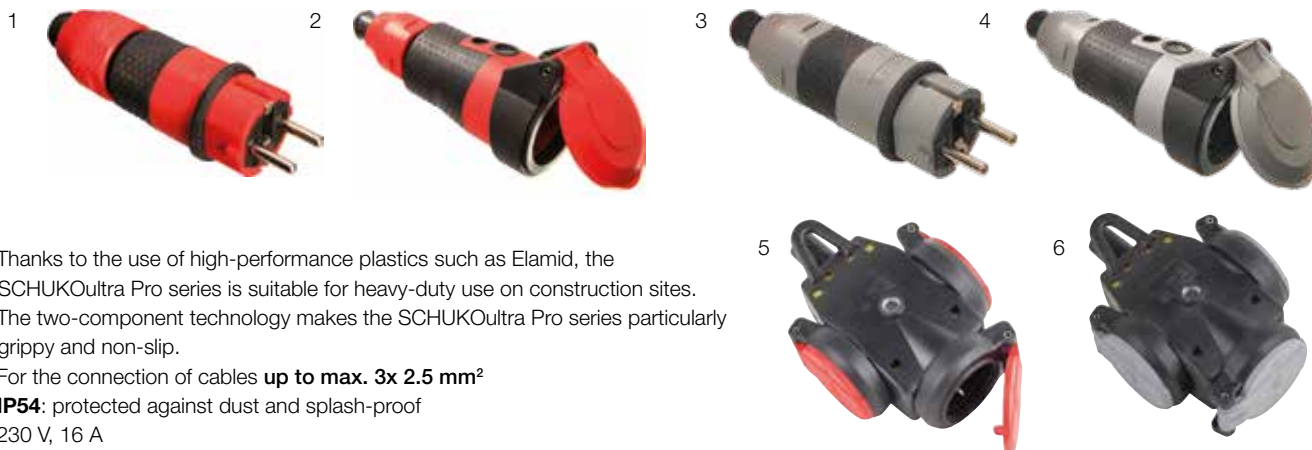

- Thanks to the use of high-performance plastics such as Elamid, the SCHUKOultra Pro series is suitable for heavy-duty use on construction sites.
- The two-component technology makes the SCHUKOultra Pro series particularly grippy and non-slip.
- For the connection of cables **up to max. 3x 2.5 mm²**
- **IP54**: protected against dust and splash-proof
- 230 V, 16 A



Fig.	Version		Colour	PU	EAN	Art. no.
1	SCHUKOultra Pro plug	With double earthing system	Red/black	10	4011160622335	62233
2	SCHUKOultra Pro connector	With flap lid and voltage indicator light	Red/black	10	4011160622434	62243
3	SCHUKOultra Pro plug	With double earthing system	Grey/black	10	4011160622328	62232
4	SCHUKOultra Pro connector	With flap lid and voltage indicator light	Grey/black	10	4011160622427	62242
5	 SCHUKOultra 3-way connector	With flap lids and voltage indicator light	Black/red	10	4011160622441	62244
6	SCHUKOultra 3-way connector	With flap lids and voltage indicator light	Black/grey	10	4011160622458	62245

Solid rubber plugs and connectors

IP44



- Heavy-duty versions for construction site use
- **IP44**: protected against foreign bodies and splash-proof
- 230 V, 16 A

Fig.	Version	For the connection of cable	Colour	PU	EAN	Art. no.
1	Solid rubber plug	Up to max. 1.5 mm²	Black	10	4011160604126	60412
2	Solid rubber connector with protective cap with hammer symbol 	Up to max. 1.5 mm²	Black	10	4011160604171	60417
3	Solid rubber plug with double earthing system	Up to max. 2.5 mm²	Black	10	4011160614125	61412
4	Solid rubber connector with protective cap with hammer symbol 	Up to max. 2.5 mm²	Black	10	4011160604195	60419
5	Solid rubber angled plug	Up to max. 2.5 mm²	Black	10	4011160622076	62207

Shock-proof plugs and connectors



Technical data

- Tested in accordance with DIN VDE 0620-2-1

Rubber plugs and connectors for outdoor use



- Versions suitable for outdoor and indoor use
- For the connection of cables **up to max. 2.5 mm²**
- **IP44**: protected against foreign bodies and splash-proof
- 230 V, 16 A

Fig.	Version		Colour	PU	EAN	Art. no.
1	Rubber plug	With double earthing system	Blue	10	4011160624018	62401
2	Rubber connector	With protective cap	Blue	10	4011160624117	62411
3	Rubber plug	With double earthing system	Black	10	4011160604102	60410
4	Rubber connector	With protective cap	Black	10	4011160604157	60415
5	Rubber plug	With double earthing system	Yellow	10	4011160624032	62403
6	Rubber connector	With protective cap	Yellow	10	4011160624131	62413

PVC plugs and connectors for indoor use

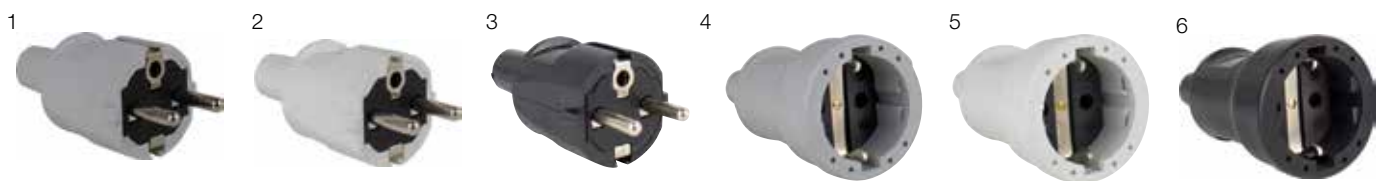

- "Made in Germany" quality products for indoor use
- For the connection of cables **up to max. 1.5 mm²**
- **IP20**: indoor use
- 230 V, 16 A

Fig.	Version		Colour	PU	EAN	Art. no.
1	Shock-proof plug	With double earthing system	Grey	10	4011160622205	62220
2	Shock-proof plug	With double earthing system	White	10	4011160622212	62221
3	Shock-proof plug	With double earthing system	Black	10	4011160622229	62222
4	Shock-proof connector		Grey	10	4011160622236	62223
5	Shock-proof connector		White	10	4011160622243	62224
6	Shock-proof connector		Black	10	4011160622250	62225

Shock-proof plugs and connectors



Technical data

- Tested in accordance with DIN VDE 0620-2-1

Shock-proof plugs and connectors for indoor use

IP20

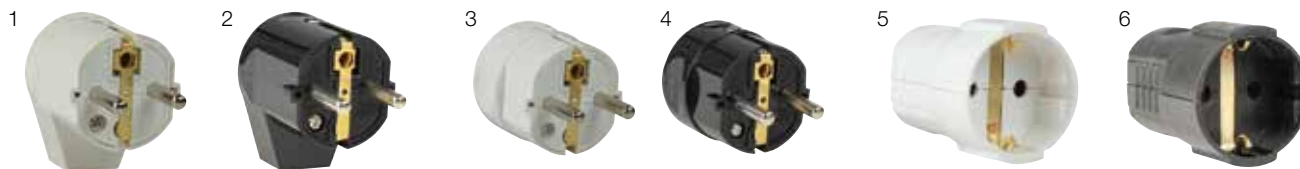

- For indoor use
- For the connection of cables **up to max. 1.5 mm²**
- **IP20:** indoor use
- 230 V, 16 A

Fig.	Version		Colour	PU	EAN	Art. no.
1	Angled plug	With double earthing system	White	10	4011160450419	45041
2	Angled plug	With double earthing system	Black	10	4011160450426	45042
3	Central plug	With double earthing system	White	10	4011160450310	45031
4	Central plug	With double earthing system	Black	10	4011160450327	45032
5	Shock-proof connector		White	10	4011160450112	45011
6	Shock-proof connector		Black	10	4011160450129	45012

Flat plugs for indoor use

IP20



Extremely flat plug fit; plug protrudes from the socket by just 7 mm.



Foldable bracket for easy removal from the socket.



- For indoor use
- With double earthing system
- For the connection of cables **up to max. 1.5 mm²**
- With foldable bracket for easy removal from the socket
- Extremely flat fit, protrudes from the socket by just 7 mm
- **IP20:** indoor use
- 230 V, 16 A



Version	Colour	PU	EAN	Art. no.
Flat plug	White	10	4011160450303	45030
Flat plug	Black	10	4011160450396	45039

Angled plugs with switch

IP20



- For indoor use
- With double earthing system
- For the connection of cables **up to max. 1.5 mm²**
- Switches on 2 poles
- **IP20:** indoor use
- 230 V, 16 A

Fig.	Version		PU	EAN	Art. no.
1	Angled plug	With illuminating switch	10	4011160450341	45034
2	Angled plug	With non-illuminating switch	10	4011160450358	45035



Test plugs for sockets

- Test functions:
 - > Earth conductor interrupted or not connected
 - > Connection and wiring OK
 - > Neutral conductor interrupted or not connected
 - > External conductor/earth conductor mixed up
- 230 V, 16 A

Version	PU	EAN	Art. no.
Test plug for shock-proof socket outlets	1	4011160451003	45100



Meaning of the indicator lights

- | | | |
|-------|----------------------|--|
| ● ● ● | Everything OK | Socket is correctly connected. |
| ● ○ ○ | Everything OK | Phase/neutral conductor mixed up (Earth OK). Change wiring if necessary. |
| ● ● ○ | Error | Earth not connected. Check wiring. |
| ○ ● ● | Error | Neutral conductor not connected. Check wiring. |
| ○ ○ ● | Error | Phase/earth mixed up. Check wiring. |

Multiple socket outlets



Technical data

- Tested in accordance with DIN VDE 0620-2-1

Shock-proof flanged sockets

IP54



- Approved for use on construction sites and in agricultural applications
- “Made in Germany” quality product
- With self-locking safety flap lids
- Flange dimensions: 50 x 50 mm
- Hole spacing: 38 mm
- **IP54**: protected against dust and splash-proof
- 230 V, 16 A



Version	Colour	PU	EAN	Art. no.
Shock-proof flanged socket	Red/black	5	4011160450808	45080
Shock-proof flanged socket	Blue	5	4011160450853	45085

3-way socket outlet

IP44

Display
model



- Approved for use on construction sites and in agricultural applications
- Material: rubber
- With self-locking safety flap lids and eyelet for suspension
- For the connection of cables **up to max. 2.5 mm²**
- **IP44**: protected against foreign bodies and splash-proof
- 230 V, 16 A

Version	Colour	PU	EAN	Art. no.
3-way socket outlet for shock-proof plugs	Blue	1	4011160600579	60057

3-way solid rubber socket outlet

IP44



- Heavy-duty version approved for use on construction sites and in agricultural applications
- “Made in Germany” quality product made from solid rubber
- With rotating, self-locking safety flap lids
- With eyelets for suspension
- For the connection of cables **up to max. 2.5 mm²**
- **IP44**: protected against foreign bodies and splash-proof
- 230 V, 16 A



Version	Colour	PU	EAN	Art. no.
3-way socket outlet for shock-proof plugs	Black	1	4011160604553	60455

4-way socket outlet

IP44



- Approved for use on construction sites and in agricultural applications
- With break-proof housing and eyelet for suspension
- With self-locking safety flap lids and hammer symbol 
- For the connection of cables **up to max. 2.5 mm²**
- **IP44**: protected against foreign bodies and splash-proof
- 230 V, 16 A

Version	Colour	PU	EAN	Art. no.
4-way socket outlet for shock-proof plugs	Black	1	4011160606007	60600

Surface mounting switches and sockets



Technical data

- Robust thermoplastic housing
- Largely UV-resistant
- With automatic terminals
- Large space for comprehensive wiring
- For the connection of cables **up to max. 2.5 mm²**
- Colour: light grey/steel grey
- Tested in accordance with DIN VDE 0620-1
- **IP54**: protected against dust and splash-proof, suitable for damp locations and outdoor use



Surface mounting switches

IP54



Fig.	Version		PU	EAN	Art. no.
1	Changeover switch	With two cable entries	10	4011160624506	62450
2	Series switch	With two cable entries	10	4011160624513	62451
3	Changeover push button	With two cable entries	10	4011160624520	62452
4	Push button – illuminated	With two cable entries	10	4011160624537	62453
5	Heating emergency switch	With two cable entries	10	4011160624544	62454
6	Combination changeover switch and socket outlet		5	4011160624551	62455

Surface mounting sockets

IP54



Fig.	Version		PU	EAN	Art. no.
1	1-way socket	With two cable entries	10	4011160624605	62460
2	1-way socket	With two cable entries	10	4011160624612	62461
3	2-way socket	With two cable entries	5	4011160624629	62462
4	2-way socket	With two cable entries	5	4011160624636	62463
5	3-way socket	With three cable entries	3	4011160624643	62464



Plugs and sockets type C

Technical data

- For the connection of cables up to max. 3G1.5
- 2-pole with shock-proof contact, screw-fastened
- Colour: black
- 230 V, 10 A
- Tested in accordance with DIN VDE 0625, IEC 60320

Sockets type C

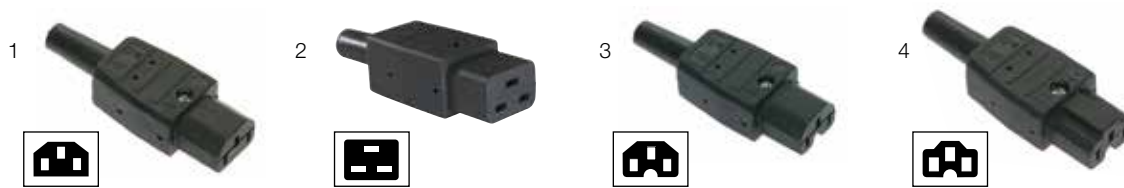

Fig.	Version	Type	PU	EAN	Art. no.
1	Device socket for appliances heating up to 70°C	C13	1	4011160620812	62081
2	Device socket for appliances heating up to 70°C	C19	1	4011160620850	62085
3	Device socket for appliances heating up to 120°C	C15	1	4011160620829	62082
4	Device socket for appliances heating up to 155°C	C15A	1	4011160620836	62083

Plugs type C



Version	Type	PU	EAN	Art. no.
Device plug for appliances heating up to 70°C	C20	1	4011160620843	62084



000000000 kWh

DRT-341A

SV-0654
EN50470-3 50Hz
3x230/400V 3KB
0,25-5(80)A

as
Schwabe

CE M18 0122
L1 L2 L3
R1=1000

6

Energy meters **86-89**

Inrush current limiters **90-91**

Energy meters & inrush current limiters



Analogue display: MID calibrated and sealed

MIXO energy meters are only ever fitted with analog displays, which are calibrated in accordance with the specifications of the calibration authority.

Simple commissioning

To correctly record the measured values, connect the energy meter between the power source and the consumer. The energy measurement will start as soon as the consumer is switched on.

Power consumption during building refurbishment

The landlord is obligated to take on the operating costs that occur during refurbishment work. Use MIXO energy meters during building refurbishment in order to deduct the used electricity from the utility invoicing for the tenant.

Billing in the event of damage

In the event of an insurance claim, e.g. for damage caused by force majeure such as flooding, MIXO energy meters are used for the electricity billing. The operating costs of a dryer can be determined using the energy meter, for example.

These costs are covered by the insurance company.

Camping use

Avoid unpleasant surprises at the end of your camping trip by using the MIXO energy meter to keep an eye on your power consumption at all times.



Electricity billing?

It's easy with **MIXO** energy meters!

In accordance with § 31 of the German Measurement and Calibration Act (MessEG), **only calibrated meters may be used for electricity billing.**

MIXO energy meters comply with the directives of the European Measuring Instruments Directive MID and are approved for **electricity billing.**

The use of **non-calibrated energy meters** for billing constitutes an **offence** punishable by a fine of up to EUR 50,000 (§ 60).

MIXO energy meter with analog display

MIXO energy meters are **portable** and are used to **record the amount of energy that is consumed**. If the consumer does not have an installed measuring device to determine the amount of energy consumed, **the calibration authority specifies that an external measuring device may be connected** via a plug connector. MIXO energy meters guarantee the manipulation-proof recording of measured values.

MIXO energy meters feature either a **shock-proof plug** or a **CEE plug** and the corresponding coupling, and are suitable for various indoor and outdoor applications.



MIXO energy meter, 1-phase, for 230 V

- 230 V, 50 Hz
- Rated current 0.25-5 A (max. 45 A)
- Analogue display 5+1 digits, readable at any time
- Display for max. 99999.9 kWh
- Non-resettable analog display
- MID calibrated 2014/32/EU
- Accuracy class 1/B
- Operating temperature from -25°C to +55°C



MIXO energy meter, 3-phase, for 400 V

- 400 V, 50 Hz
- Rated current 0.25-5 A (max. 80 A)
- Analogue display 6+1 digits, readable at any time
- Display for max. 999999.9 kWh
- Non-resettable analog display
- MID calibrated 2014/32/EU
- Accuracy class 1/B
- Operating temperature from -25°C to +55°C





MIXO energy meters

Technical data

- Approved for use on construction sites and in agricultural applications
- Housing made from shatterproof special plastic
- Integrated energy meter, MID calibrated and sealed
- Analog display cannot be reset to 0
- With shock-proof plug and shock-proof connector
- Tested in accordance with DIN EN 50525-2, DIN VDE 0620-2-1, IEC 60309, IEC EN 50470-1
- **IP44**: protected against foreign bodies and splash-proof



MIXO energy meter with shock-proof plug

IP44



Art. no. 61747

- 230 V, 50 Hz
- Rated current 0.25-5 A (max. 45 A)
- Analogue display 5+1 digits,
- Readable at any time
- Display for max. 99999.9 kWh
- Non-resettable analog display
- MID calibrated 2014/32/EU
- Accuracy class 1/B
- Operating temperature from -25°C to +55°C

With heavy-duty rubber power cable

RN

With shock-proof plug	PU	EAN	Art. no.
2x1.5 m H07RN-F 3G2.5	1	4011160617478	61747



Art. no. 61742

With polyurethane construction site cable

BQ

With shock-proof plug	PU	EAN	Art. no.
2x1.5 m H07BQ-F 3G2.5	1	4011160617423	61742
2x1.5 m H07BQ-F 3G2.5 with RCD 30 mA	1	4011160617447	61744



Art. no. 61744

MIXO energy meters



Technical data

- Approved for use on construction sites and in agricultural applications
- Housing made from shatterproof special plastic
- Integrated energy meter, MID calibrated and sealed
- Analog display cannot be reset to 0
- With CEE plug and CEE connector
- Tested in accordance with DIN EN 50525-2, DIN VDE 0620-2-1, IEC 60309, IEC EN 50470-1
- **IP44**: protected against foreign bodies and splash-proof

MIXO energy meter with CEE plug 230 V

IP44



- 230 V, 50 Hz
- Rated current 0.25-5 A (max. 45 A)
- Analogue display 5+1 digits,
- Readable at any time
- Display for max. 99999.9 kWh
- Non-resettable analog display
- MID calibrated 2014/32/EU
- Accuracy class 1/B
- Operating temperature from -25°C to +55°C

With heavy-duty rubber power cable

RN

With CEE plug	PU	EAN	Art. no.
2x 1.5 m H07RN-F 3G2.5	230 V, 16 A, 3-pole, approx. 3.5 kW	1 4011160617485	61748

MIXO energy meter with CEE plug 400 V

IP44



- 400 V, 50 Hz
- Rated current 0.25-5 A (max. 80 A)
- Analogue display 6+1 digits,
- Readable at any time
- Display for max. 999999.9 kWh
- Non-resettable analog display
- MID calibrated 2014/32/EU
- Accuracy class 1/B
- Operating temperature from -25°C to +55°C

With heavy-duty rubber power cable

RN

With CEE plug	PU	EAN	Art. no.
2x 1.5 m H07RN-F 5G2,5	400 V, 16 A, 5-pole, approx. 11 kW	1 4011160617454	61745
2x 1.5 m H07RN-F 5G6	400 V, 32 A, 5-pole, approx. 22 kW	1 4011160617461	61746

Solid rubber multi socket outlet with energy meter 400 V

IP44

NEU



- Multi socket outlet with built-in MID calibrated energy meter (3-phase)
- Suitable for billing purposes as MID calibrated
- Output: 400 V, 63 A, approx. 43 kW
- 3x 230/400 V AC; 5 (80) A
- Analogue display 6+1 digits, readable at any time
- Display for max. 999999.9 kWh
- Non-resettable analog display

With heavy-duty rubber power cable

RN

With CEE plug	PU	EAN	Art. no.
2 m H07RN-F 5G16	400 V, 63 A, 5-pole, approx. 43 kW	1 4011160608742	60874



© skynesher

MIXO

inrush current limiter

Outstanding partner for your safety!

Inrush current limiters reduce current spikes that can occur when switching on electrical devices, thereby ensuring a continual supply of power on the construction site. They are normally used when working with welding equipment, angle grinders or circular saws, thereby helping to ensure safe working with heavy machinery.

When devices are switched on, there are temporarily very high inrush currents that can cause the fuse to blow. Inrush current limiters curb these temporary current spikes and reduce the value in order not to blow the fuse.

Areas of application:

Angle grinders, high-pressure cleaners, welding equipment, shredders and similar devices with inductive components

Please note:

The inrush current limiter will not work if multiple devices are connected at the same time!

MIXO inrush current limiters



MIXO inrush current limiter 230 V/16 A

IP44



- Approved for use on construction sites and in agricultural applications
- Input: with shock-proof plug
- Output: with shock-proof socket outlet, splash-proof
- Voltage: U = 230 V AC, 50-60 Hz
- Suitable for 16 A circuit breakers with tripping characteristics B and C
- Max. switch-on frequency per minute: 2-15 (depending on consumption)
- Max. load capacity: 3500 W
- Tested in accordance with DIN EN 50525-2, DIN VDE 0620-2-1
- **IP44**: protected against foreign bodies and splash-proof

With heavy-duty rubber power cable

RN

Version	Colour	PU	EAN	Art. no.
1.5 m H07RN-F 3G1.5	Black/blue	1	4011160605338	60533

MIXO inrush current limiter 400 V/16 A

IP44



- Approved for use on construction sites and in agricultural applications
- Input: with CEE plug 400 V, 16 A, 5-pole
- Output: with CEE socket 400 V, 16 A, 5-pole
- Voltage: U = 400 V AC, 50-60 Hz
- Suitable for 16 A circuit breakers with tripping characteristics C and D
- Max. switch-on frequency per minute: 1
- Max. load capacity: 11000 W
- Tested in accordance with DIN EN 50525-2, DIN VDE 0620-2-1, IEC 60309
- **IP44**: protected against foreign bodies and splash-proof

With heavy-duty rubber power cable

RN

Version	Colour	PU	EAN	Art. no.
1.5 m H07RN-F 5G1.5	Black/red	1	4011160607400	60740



Power cubes

94-95

Suspended distributors

96-97

Power cubes & suspended distributors

MIXO power cube



Technical data

- Housing made from shatterproof special plastic
- All power cubes are wired ready for connection
- Includes cable gland and chain with snap hooks
- Tested in accordance with DIN VDE 0620, IEC 60309
- **IP44**: protected against foreign bodies and splash-proof



Available with and without compressed air connection.



All power cubes without data socket have a practical multi-purpose hook on one side.

Legend

- Shock-proof socket outlet 230 V, 16 A, 2 PE
- CEE socket 400 V, 16 A, 5-pole
- CEE socket 400 V, 32 A, 5-pole
- Data connection 2x RJ45 Cat. 6 module IP67
- Compressed air connection NW 7.2



Art. no. 60731



Art. no. 60733



Art. no. 60734



Art. no. 60766



Art. no. 60764

MIXO power cube

IP44

Type	Output	For cable diameter	Weight	PU	EAN	Art. no.
I	4x shock-proof socket outlets 230 V, 16 A, 2 PE 	3 x 1.5 mm ² to 5 x 1.5 mm ²	1.3 kg	1	4011160607318	60731
II	4x shock-proof socket outlets 230 V, 16 A, 2 PE 1x CEE socket 400 V, 16 A, 5-pole 	5 x 1.5 mm ² to 5 x 2.5 mm ²	1.3 kg	1	4011160607332	60733
III	2x shock-proof socket outlets 230 V, 16 A, 2 PE 2x CEE socket 400 V, 16 A, 5-pole 	5 x 2.5 mm ² to 5 x 4 mm ²	1.3 kg	1	4011160607356	60735
IV	3x CEE sockets 400 V, 16 A, 5-pole 	5 x 2.5 mm ² to 5 x 4 mm ²	1.3 kg	1	4011160607370	60737
V	3x CEE sockets 400 V, 32 A, 5-pole 	5 x 4 mm ² to 5 x 6 mm ²	1.3 kg	1	4011160607394	60739









Extension chain, sold by metre

	PU	EAN	Art. no.
Running metre Extension chain for suspending the power cube	1	4011160610707	61070



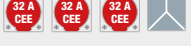

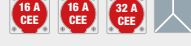
MIXO power cube  with compressed air connection

IP44

Type	Output	For cable diameter	Weight	PU	EAN	Art. no.
I+	4x shock-proof socket outlets 230 V, 16 A, 2 PE 	3 x 1.5 mm ² to 5 x 1.5 mm ²	1.3	1	4011160607325	60732
II+	4x shock-proof socket outlets 230 V, 16 A, 2 PE 1x CEE socket 400 V, 16 A, 5-pole 	5 x 1.5 mm ² to 5 x 2.5 mm ²	1.3	1	4011160607349	60734
III+	2x shock-proof socket outlets 230 V, 16 A, 2 PE 2x CEE sockets 400 V, 16 A, 5-pole 	5 x 2.5 mm ² to 5 x 4 mm ²	1.3	1	4011160607363	60736
IV+	3x CEE sockets 400 V, 16 A, 5-pole 	5 x 2.5 mm ² to 5 x 4 mm ²	1.3	1	4011160607387	60738
V+	3x CEE sockets 400 V, 32 A, 5-pole 	5 x 4 mm ² to 5 x 6 mm ²	1.3	1	4011160607301	60730
VI+	1x shock-proof socket outlet 230 V, 16 A, 2 PE 1x CEE socket 400 V, 16 A, 5-pole 1x CEE socket 400 V, 32 A, 5-pole 3x G fuses (10 A), non-resettable, time-delay T10 A, SPT 5x20 m 	5 x 4 mm ² to 5 x 6 mm ²	1.5	1	4011160607516	60751
VII+	2x CEE sockets 400 V, 16 A, 5-pole 1x CEE socket 400 V, 32 A, 5-pole 3x G fuses (10 A), non-resettable, time-delay T10 A, SPT 5x20 m 	5 x 4 mm ² to 5 x 6 mm ²	1.5	1	4011160607530	60753

MIXO power cube   with compressed air and data connection

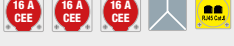
IP44

Type	Output	For cable diameter	Weight	PU	EAN	Art. no.
II DAT+	4x shock-proof socket outlets 230 V, 16 A, 2 PE 1x CEE socket 400 V, 16 A, 5-pole 2 x RJ45 Cat. 6 module IP67 	5 x 1.5 mm ² to 5 x 2.5 mm ²	1.4	1	4011160607646	60764
III DAT+	2x shock-proof socket outlets 230 V, 16 A, 2 PE 2x CEE sockets 400 V, 16 A, 5-pole 2 x RJ45 Cat. 6 module IP67 	5 x 2.5 mm ² to 5 x 4 mm ²	1.7	1	4011160607660	60766
IV DAT+	3x CEE sockets 400 V, 16 A, 5-pole 2 x RJ45 Cat. 6 module IP67 	5 x 2.5 mm ² to 5 x 4 mm ²	1.4	1	4011160607684	60768
VI DAT+ without hook	1x shock-proof socket outlet 230 V, 16 A, 2 PE 1x CEE socket 400 V, 16 A, 5-pole 1x CEE socket 400 V, 32 A, 5-pole 2 x RJ45 Cat. 6 module IP67 3x G fuses (10 A), non-resettable, time-delay T10 A, SPT 5x20 m 	5 x 4 mm ² to 5 x 6 mm ²	1.6	1	4011160607813	60781

Galvanised
steel link chain



Compressed
air hose

Pneumatic
valve

Handle
Tool hook

Current and compressed air
in the correct amounts right where they're needed

Suspended distributors



Technical data

- Suspended distributors provide current and compressed air in the correct amounts right where they're needed
- Housing made from special plastic with handle or tool hook
- With 3 m compressed air hose (inner diameter x wall thickness: 9 x 3 mm)
- Pneumatic valves made from bare brass
- Includes 3 m stable galvanised steel link chain
- Distributor with compressed air connection with convenient quick connection connector NW 7.2 and plug-in nipple
- Compressed air supply loadable up to 12 bar, 180 psi

Legend



Shock-proof socket outlet 230 V, 16 A, 2 PE



Compressed air connection NW 7.2



WATZMANN





ZUGSPITZE

Without compressed air supply and with 8 sockets: four on the front and four on the back.



Suspended distributors without compressed air supply

IP20/IP44

Type	Input	Output	PU	EAN	Art. no.
WATZMANN	3 m H05VV-F 3G1,5 PVC cable with shock-proof plug	2x 4 shock-proof socket outlets 230 V, 16 A, 2 PE open, IP20 	1	4011160609718	60971
ZUGSPITZE	3 m H07RN-F 3G1,5 Heavy-duty rubber power cable with shock-proof plug	2x 4 shock-proof socket outlets 230 V, 16 A, 2 PE with flap lids, IP44 	1	4011160609732	60973



BELCHEN





FELDBERG

With compressed air supply and with 4 sockets on the front.



Suspended distributors with compressed air supply

IP20/IP44

Type	Input	Output	PU	EAN	Art. no.
BELCHEN	3 m H05VV-F 3G1,5 PVC cable with shock-proof plug	4x shock-proof socket outlets 230 V, 16 A, 2 PE open, IP20 	1	4011160609725	60972
FELDBERG	3 m H07RN-F 3G1,5 Heavy-duty rubber power cable with shock-proof plug	4x shock-proof socket outlets 230 V, 16 A, 2 PE with flap lids, IP44 	1	4011160609749	60974



8

CEE plugs and connectors	100-102
CEE sockets	103-104
CEE extensions	105-107
CEE construction site power combination unit cabinets	108-113
Cable bridges	114-115
CEE construction site power combination unit series M	116-119
CEE multi socket outlets series S	120-123
MIXO CEE adapters	124-127
STECKY CEE combination units	128-133
FIXO CEE combination units	134-135

CEE 400 V range

High-quality plug connectors

as - Schwabe stands for high-quality products. That's why we use quality plugs and connectors from our partners when installing various cables and other products. The results are "Made in Germany" quality products.



 **MENNEKES**
MY POWER CONNECTION



Mennekes PowerTOP® Xtra 63 A and 125 A

The integrated opening aid on the connector lid makes it easier to open the flap lid and keep it in place. The immediately adjacent screw connection on the plug or connector hood means that the surface is easy to clean.

The seals in the connector lid and the front of the plug are moulded on and therefore undetachable. The plug and connector housings are ergonomic in shape, and are characterised by an excellent grip even in moisture, snow and dirt thanks to the practical rubberised finish on the grip surfaces.

The front part and the hood can be quickly and securely locked via a screw cap. Unlocking can only be performed using a tool, in line with the regulations.

The plugs provide improved corrosion protection in aggressive environments and in high humidities thanks to their nickel-plated contacts. And the high-heat-resistant contact carrier also ensures extra safety.

With their x-shaped slot pattern and grooves in the inner walls, the innovative X-CONTACT® sleeves provide a particularly secure contact closure while simultaneously reducing the plug-in and removal forces by up to 50%. There are no signs of wear even with frequent plugging in and removing under load, and the sleeve material remains permanently fatigue-free even with rough handling.

All PowerTOP® Xtra connecting devices comply with the amended regulation EN/IEC 60 309-2.

They are finger-safe in accordance with BGV [German trade association provisions] A3, formerly VBG 4.

X-CONTACT®



CEE plugs and connectors 400 V



Technical data

- Tested in accordance with IEC 60309, EN 60309, VDE 0623
- **IP44**: protected against foreign bodies and splash-proof
- **IP67**: dust-proof and water-tight with temporary submersion



CEE plugs and connectors



IP44



- Latest generation high-quality plugs with impact-resistant, splash-proof polyamide housing
- Housing with threaded fastener and locking slide
- With screw contact for cable connection
- Screw connection with seal
- Strain relief and cable kink protection
- Made in Germany

Fig.	Version		PU	EAN	Art. no.
1	CEE plug	400 V 16 A 5-pole 6 h	5	4011160614200	61420
1	CEE plug	400 V 32 A 5-pole 6 h	5	4011160614224	61422
2	CEE connector	400 V 16 A 5-pole 6 h	5	4011160614255	61425
2	CEE connector	400 V 32 A 5-pole 6 h	5	4011160614279	61427
3	Phase inverter	400 V 16 A 5-pole 6 h	5	4011160614606	61460
3	Phase inverter	400 V 32 A 5-pole 6 h	5	4011160614613	61461

CEE plugs and connectors



IP44/IP67



- Latest generation high-quality connectors with impact-resistant, splash-proof polyamide housing
- Housing with threaded fastener and locking slide
- With screw contact for cable connection
- Screw connection with seal (IP67)
- Strain relief and cable kink protection
- With rubberised grip surfaces
- Made in Germany

Fig.	Version		PU	EAN	Art. no.
1	CEE plug	IP44 400 V 63 A 5-pole 6 h	5	4011160614231	61423
2	CEE plug	IP67 400 V 125 A 5-pole 6 h	5	4011160614248	61424
3	CEE connector	IP44 400 V 63 A 5-pole 6 h	5	4011160614286	61428
4	CEE connector	IP67 400 V 125 A 5-pole 6 h	5	4011160614293	61429

CEE plugs and connectors 400 V



Technical data

- Tested in accordance with IEC 60309
- **IP44:** protected against foreign bodies and splash-proof
- **IP67:** dust-proof and water-tight with temporary submersion

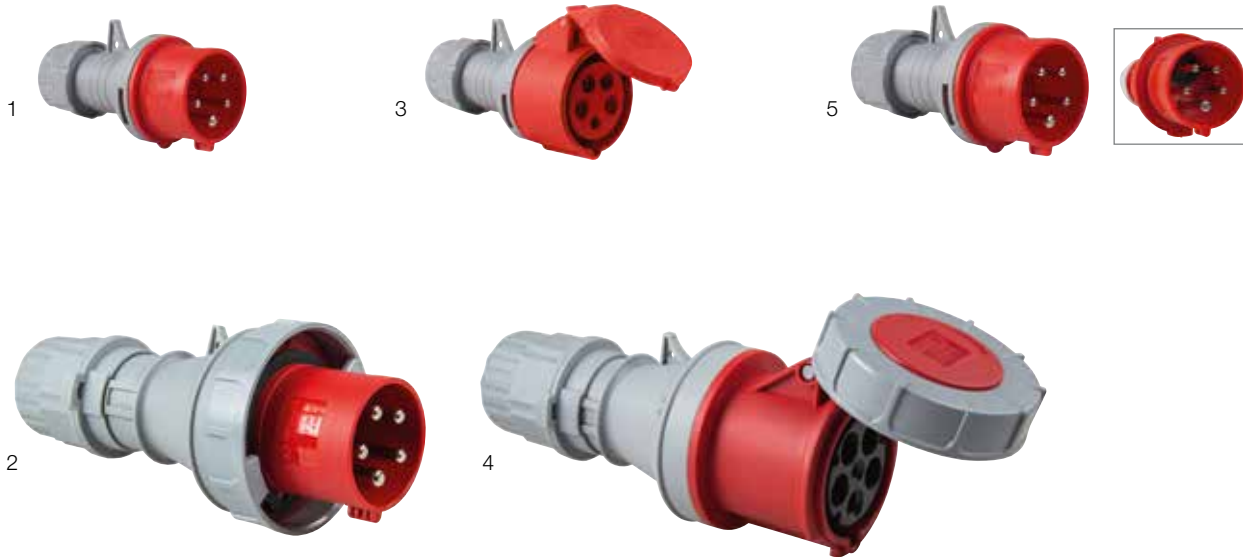

CEE plugs, CEE connectors and CEE phase inverters

IP44/IP67

- With impact-resistant, splash-proof polyamide housing
- With screw contact for cable connection

Fig.	Version						PU	EAN	Art. no.
1	CEE plug	IP44	400 V	16 A	5-pole	6 h	5	4011160604201	60420
1	CEE plug	IP44	400 V	16 A	4-pole	6 h	5	4011160605703	60570
1	CEE plug	IP44	400 V	32 A	5-pole	6 h	5	4011160604225	60422
1	CEE plug	IP44	400 V	32 A	4-pole	6 h	5	4011160605727	60572
2	CEE plug	IP67	400 V	63 A	5-pole	6 h	1	4011160604232	60423
3	CEE connector	IP44	400 V	16 A	5-pole	6 h	5	4011160604256	60425
3	CEE connector	IP44	400 V	16 A	4-pole	6 h	5	4011160605758	60575
3	CEE connector	IP44	400 V	32 A	5-pole	6 h	5	4011160604270	60427
3	CEE connector	IP44	400 V	32 A	4-pole	6 h	5	4011160605765	60576
4	CEE connector	IP67	400 V	63 A	5-pole	6 h	1	4011160604287	60428
5	CEE phase inverter	IP44	400 V	16 A	5-pole	6 h	5	4011160604607	60460
5	CEE phase inverter	IP44	400 V	32 A	5-pole	6 h	5	4011160604614	60461

CEE wall-mounted socket outlets and plugs 400 V



Technical data

- Tested in accordance with DIN VDE 0620-2-1, IEC 60309
- **IP44**: protected against foreign bodies and splash-proof



CEE wall-mounted socket outlets

IP44



- CEE wall-mounted socket outlet with impact-resistant, splash-proof polyamide housing
- With screw connections

Fig.	Version		PU	EAN	Art. no.
1	CEE wall-mounted socket outlet	400 V 16 A 5-pole 6 h	5	4011160604300	60430
None	CEE wall-mounted socket outlet	400 V 16 A 4-pole 6 h	5	4011160605789	60578
1	CEE wall-mounted socket outlet	400 V 32 A 5-pole 6 h	5	4011160604324	60432
None	CEE wall-mounted socket outlet	400 V 32 A 4-pole 6 h	5	4011160605796	60579
2	CEE wall-mounted socket outlet	400 V 63 A 5-pole 6 h	1	4011160604348	60434

CEE wall-mounted socket outlets with shock-proof socket outlet

IP44



- CEE wall-mounted socket outlet with integrated shock-proof socket outlet
- With impact-resistant, splash-proof polyamide housing
- With screw connections

Fig.	Version		PU	EAN	Art. no.
1	CEE combi socket	400 V 16 A 5-pole 6 h	5	4011160604379	60437
2	CEE combi socket with G fuse 10 A	400 V 32 A 5-pole 6 h	5	4011160604386	60438

CEE panel-mounted sockets and inlets

IP44



- CEE panel-mounted sockets and plugs with impact-resistant, splash-proof polyamide housing
- With screw connections
- Flange dimensions: 75 x 75 mm
- Hole dimensions: 60 x 60 mm

Fig.	Version		PU	EAN	Art. no.
1	CEE wall-mounted inlet	400 V 16 A 5-pole 6 h	5	4011160604430	60443
1	CEE wall-mounted inlet	400 V 32 A 5-pole 6 h	1	4011160604447	60444
2	CEE wall-mounted device socket	400 V 16 A 5-pole 6 h	5	4011160604409	60440
2	CEE wall-mounted device socket	400 V 32 A 5-pole 6 h	1	4011160604416	60441

CEE wall-mounted inlet

IP44



- CEE wall-mounted inlet with impact-resistant, splash-proof polyamide housing
- With screw connections

Version		PU	EAN	Art. no.
CEE wall-mounted inlet	400 V 16 A 5-pole 6 h	5	4011160604355	60435
CEE wall-mounted inlet	400 V 16 A 4-pole 6 h	5	4011160605819	60581
CEE wall-mounted inlet	400 V 32 A 5-pole 6 h	5	4011160604362	60436

The test plug is used for the **safe checking of the rotating field direction** in CEE sockets. In accordance with VDE 0100 § 31b 5, three-phase sockets must be connected such that there is a **clockwise rotating field** when looking at the sockets from the front in a clockwise direction. The **three indicator lights** on the test plug indicate a clockwise or anti-clockwise rotating field as well as indicating if a phase is missing.



Meaning of the indicator lights



Everything OK Phases connected in the correct sequence.



Everything OK Phases not connected in the correct sequence. Change wiring if necessary.



Error A phase is missing. Check wiring.



Error Earth or neutral conductor not connected. Check wiring.



Error Earth or neutral conductor connected to phase. Check wiring.

Connection and rotating field test plugs for CEE sockets

IP44



- With impact-resistant, splash-proof polyamide housing
- Tested in accordance with IEC 60309
- 400 V/16 A or 400 V/32 A

Fig.	Version	PU	EAN	Art. no.
1	16 A 5-pole 6 h	5	4011160614774	61477
2	32 A 5-pole 6 h	5	4011160614781	61478

CEE extensions



Safety

- Tested in accordance with IEC 60309, DIN EN 50525-2
- **IP44**: protected against foreign bodies and splash-proof



Construction site extensions

IP44

- CEE plug and CEE connector with flap lid
- Latest generation “Made in Germany” plugs and connectors
- 400 V, 5-pole, 6 h



Heavy-duty polyurethane power cable

BQ

16 A, approx. 11 kW	Colour	PU	EAN	Art. no.
10 m H07BQ-F 5G1.5	Orange	1	4011160595103	59510
10 m H07BQ-F 5G1.5 with phase inverter	Orange	1	4011160605659	60565
25 m H07BQ-F 5G1.5	Orange	1	4011160595257	59525
25 m H07BQ-F 5G1.5 with phase inverter	Orange	1	4011160605635	60563
10 m H07BQ-F 5G2.5	Orange	1	4011160596100	59610
10 m H07BQ-F 5G2.5 with phase inverter	Orange	1	4011160605642	60564
25 m H07BQ-F 5G2.5	Orange	1	4011160596254	59625
25 m H07BQ-F 5G2.5 with phase inverter	Orange	1	4011160605628	60562

32 A, approx. 22 kW	Colour	PU	EAN	Art. no.
10 m H07BQ-F 5G4	Orange	1	4011160596261	59626
10 m H07BQ-F 5G4 with phase inverter	Orange	1	4011160596469	59646
25 m H07BQ-F 5G4	Orange	1	4011160596278	59627
25 m H07BQ-F 5G4 with phase inverter	Orange	1	4011160596476	59647
50 m H07BQ-F 5G4	Orange	1	4011160596285	59628
50 m H07BQ-F 5G4 with phase inverter	Orange	1	4011160596483	59648
10 m H07BQ-F 5G6	Orange	1	4011160596292	59629
10 m H07BQ-F 5G6 with phase inverter	Orange	1	4011160596490	59649
25 m H07BQ-F 5G6	Orange	1	4011160596230	59623
25 m H07BQ-F 5G6 with phase inverter	Orange	1	4011160596438	59643
50 m H07BQ-F 5G6	Orange	1	4011160596247	59624
50 m H07BQ-F 5G6 with phase inverter	Orange	1	4011160596445	59644

Construction site retractable spiral cords

IP44

NEW



- Retractable spiral cord with high-quality CEE plug and CEE connector with flap lid
- Latest generation “Made in Germany” plugs and connectors
- Basic length approx. 1 m, flexibly elastic up to 5 m, retracts again automatically
- Remains highly flexibly even with continual use
- 400 V, 5-pole, 6 h

Heavy-duty polyurethane power cable

BQ

16 A, approx. 11 kW	extendable	Colour	PU	EAN	Art. no.
1 m H07BQ-F 5G1.5	up to 5 m	Orange	1	4011160704161	70416
1 m H07BQ-F 5G2.5	up to 5 m	Orange	1	4011160704192	70419



Heavy-duty polyurethane power cable

BQ

BQ cables have a rubber conductor insulation and are coated with **polyurethane in an orange safety** colour. They are **oil-resistant**, extremely **abrasion-resistant** and permissible for use at temperatures **from -40 to 80°C**. They are particularly well-suited to use on construction sites and in industrial applications, in **dry, damp or wet environments**, in industrial water and outdoors, as well as in agricultural sites and areas with a high risk of fire. They are suitable for **long-term outdoor use**.

CEE extensions



Safety

- Tested in accordance with IEC 60309, DIN EN 50525-2
- **IP44**: protected against foreign bodies and splash-proof



CEE extensions

IP44

- Approved for use on construction sites and in agricultural applications
- With high-quality CEE plug and CEE connector with protective cap
- Latest generation “Made in Germany” plugs and connectors
- 400 V, 5-pole, 6 h



Heavy-duty rubber cable

RN

16 A, approx. 11 kW

	Colour	PU	EAN	Art. no.
5 m H07RN-F 5G1.5	Black	1	4011160612053	61205
5 m H07RN-F 5G1.5 with phase inverter	Black	1	4011160605956	60595
10 m H07RN-F 5G1.5	Black	1	4011160603662	60366
10 m H07RN-F 5G1.5 with phase inverter	Black	1	4011160605666	60566
25 m H07RN-F 5G1.5	Black	1	4011160603686	60368
25 m H07RN-F 5G1.5 with phase inverter	Black	1	4011160605680	60568
50 m H07RN-F 5G1.5	Black	1	4011160605123	60512
5 m H07RN-F 5G2.5	Black	1	4011160613609	61360
5 m H07RN-F 5G2.5 with phase inverter	Black	1	4011160613647	61364
10 m H07RN-F 5G2.5	Black	1	4011160610103	61010
10 m H07RN-F 5G2.5 with phase inverter	Black	1	4011160605178	60517
25 m H07RN-F 5G2.5	Black	1	4011160610158	61015
25 m H07RN-F 5G2.5 with phase inverter	Black	1	4011160605482	60548
50 m H07RN-F 5G2.5	Black	1	4011160610172	61017
50 m H07RN-F 5G2.5 with phase inverter	Black	1	4011160610936	61093

32 A, approx. 22 kW



	Colour	PU	EAN	Art. no.
1.6 m H07RN-F 5G4	Black	1	4011160610974	61097
5 m H07RN-F 5G4	Black	1	4011160613050	61305
5 m H07RN-F 5G4 with phase inverter	Black	1	4011160613067	61306
10 m H07RN-F 5G4	Black	1	4011160610271	61027
10 m H07RN-F 5G4 with phase inverter	Black	1	4011160605499	60549
25 m H07RN-F 5G4	Black	1	4011160610257	61025
25 m H07RN-F 5G4 with phase inverter	Black	1	4011160605185	60518
50 m H07RN-F 5G4	Black	1	4011160610264	61026
50 m H07RN-F 5G4 with phase inverter	Black	1	4011160605215	60521
5 m H07RN-F 5G6	Black	1	4011160613357	61335
5 m H07RN-F 5G6 with phase inverter	Black	1	4011160613364	61336
10 m H07RN-F 5G6	Black	1	4011160610318	61031
10 m H07RN-F 5G6 with phase inverter	Black	1	4011160610387	61038
25 m H07RN-F 5G6	Black	1	4011160610288	61028
25 m H07RN-F 5G6 with phase inverter	Black	1	4011160605192	60519
50 m H07RN-F 5G6	Black	1	4011160610349	61034
50 m H07RN-F 5G6 with phase inverter	Black	1	4011160605130	60513



CEE extensions



Safety

- Tested in accordance with IEC 60309, DIN EN 50525-2



CEE extensions

IP44/IP67

- Approved for use on construction sites and in agricultural applications
- With high-quality CEE plug and CEE connector with flap lid
- Extremely robust, impact-resistant and excellent grip thanks to the unique rubberised finish on the grip surfaces
- **IP44**: protected against foreign bodies and splash-proof
- **IP67**: dust-proof and water-tight with temporary submersion
- 400 V, 5-pole, 6 h

Heavy-duty rubber cable

RN

Fig.	63 A, approx. 43 kW, IP44	Colour	PU	EAN	Art. no.
1	10 m H07RN-F 5G16	Black	1	4011160610394	61039
1	25 m H07RN-F 5G16	Black	1	4011160610400	61040
1	50 m H07RN-F 5G16	Black	1	4011160610417	61041
Fig.	125 A, approx. 86 kW, IP67	Colour	PU	EAN	Art. no.
2	25 m H07RN-F 5G35	Black	1	4011160610806	61080
2	50 m H07RN-F 5G35	Black	1	4011160610813	61081

An overview of all details

Construction site power combination unit in a stable, **lockable** steel cabinet with **galvanised components** and with **hammer finish enamel**.



Stable, foldable **lifting eyes**



Safety chain



Door lock



Foldable **transport handles** on both sides of the housing



Swivelling **installation plate** with travel limitation



Welded frame with stable **strain relief**



Hot-dip galvanised frame with **fastening straps for earth spikes**



Easily accessible **earthing screw**

CEE construction site power combination unit cabinets



A construction site power combination unit is a **mobile switching and connection device for the supply of power** on construction sites. **All types of machinery and devices** must always be connected via a construction site power combination unit for use on a construction site. This is the only device that has the necessary safeguards consisting of both an **earthing mechanism** and a **residual current device (RCD)**.

DIN VDE 0100-704 standard amendment 2018:

With our construction site power combination units, you can be sure that you're complying with the state of the art.



CEE construction site power combination unit



Technical data

- Construction site power combination unit in a stable steel cabinet painted with a blue paint free from heavy metals
- Lockable single door with spring-loaded bolt for padlock and recessed grip
- With transport grips on the side, two lifting eyes at the top, strain relief rail, fastening straps for earth spikes and earthing screw
- **DS meter board in accordance with DIN 43870/2** available: Meter not included with the delivery
- Tested in accordance with DIN EN 61439, compliant with DIN VDE 0100-704
- **IP44:** with closed door, IP21: with open door

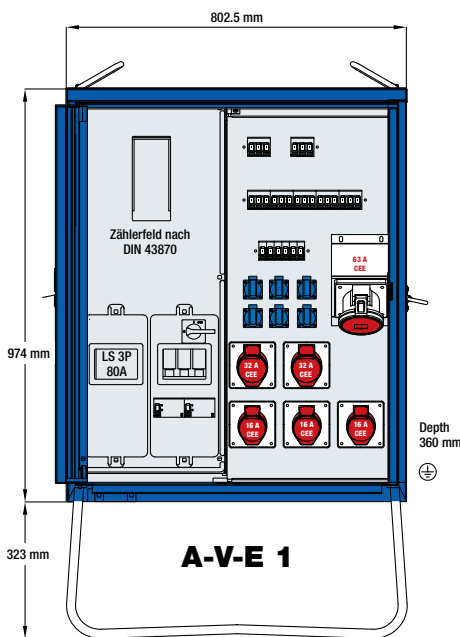

A-V-E 1

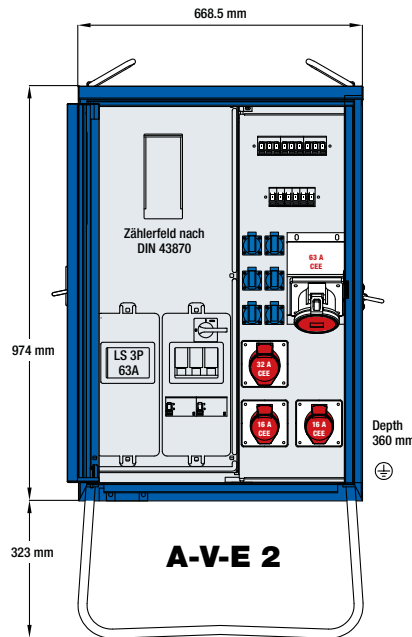

A-V-E 2

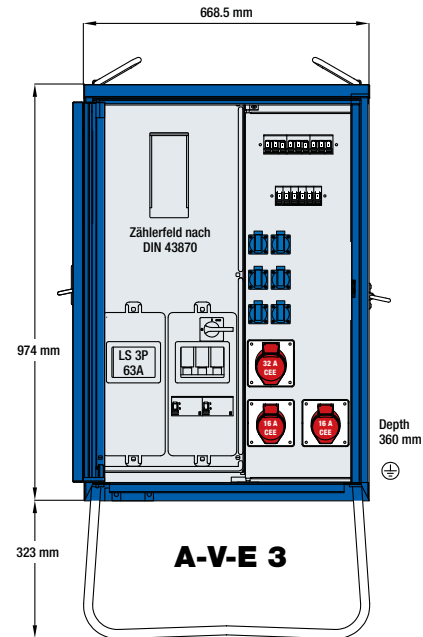

A-V-E 3

A-V-E 1 55 kVA

Input

Cable insertion M63 with strain relief up to max. 50 mm²

Connection protective device:

1x NH00 fuse switch with 100 A with U-clamp terminal 10-50mm²

Output

1x CEE socket 400 V, 63 A, 5-pole
2x CEE sockets 400 V, 32 A, 5-pole
3x CEE sockets 400 V, 16 A, 5-pole
6x shock-proof socket outlets 230 V, 16 A



Output protective device

1x MCB 3P 80A with thermal-magnetic trigger
1x RCD 63 A, 4-pole, 300 mA, type B, all-current-sensitive
1x RCD 63 A, 4-pole, 30 mA, type B, all-current-sensitive
1x MCB D 50 A, 3-pole
1x MCB C 50 A, 3-pole
2x MCB C 32 A, 3-pole
3x MCB C 16 A, 3-pole
6x MCB C 16 A, 1-pole

A-V-E 2 44 kVA

Input

Cable insertion M63 with strain relief up to max. 50 mm²

Connection protective device:

1x NH00 fuse switch with 80 A with U-clamp terminal 10-50mm²

Output

1x CEE socket 400 V, 63 A, 5-pole
1x CEE socket 400 V, 32 A, 5-pole
2x CEE sockets 400 V, 16 A, 5-pole
6x shock-proof socket outlets 230 V, 16 A



Output protective device

1x MCB 3P 63A with thermal-magnetic trigger
1x RCD 63 A, 4-pole, 300 mA, type B, all-current-sensitive
1x RCD 63 A, 4-pole, 30 mA, type B, all-current-sensitive
1x MCB C 32 A, 3-pole
2x MCB C 16 A, 3-pole
6x MCB C 16 A, 1-pole

A-V-E 3 44 kVA

Input

Cable insertion M63 with strain relief up to max. 50 mm²

Connection protective device:

1x NH00 fuse switch with 80 A with U-clamp terminal 10-50mm²

Output

1x CEE socket 400 V, 32 A, 5-pole
2x CEE sockets 400 V, 16 A, 5-pole
6x shock-proof socket outlets 230 V, 16 A



Output protective device

1x MCB 3P 63A with thermal-magnetic trigger
1x RCD 63 A, 4-pole, 30 mA, type B, all-current-sensitive
1x RCD 40 A, 4-pole, 30 mA, type A, positive-current-sensitive
1x MCB C 32 A, 3-pole
2x MCB C 16 A, 3-pole
6x MCB C 16 A, 1-pole

DIN VDE 0100-704 standard amendment 2018:

Are up complying with the state of the art? We are.

As of 2020, the new standard must be complied with when a construction site is first set up or if any changes are made to the power combination unit while the construction site is in operation.

All of our construction site power combination units comply with user standard DIN VDE 0100-704. So you're always on the safe side.

Section 704.537.101 also states:

"Fixed connected construction site power combination units with sockets must contain devices for disconnecting the feed, which can be locked to prevent switch-on and which can be used by laypersons. A lockable cover is not sufficient".

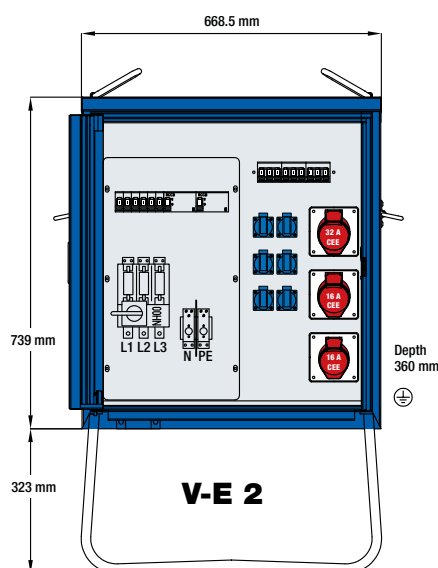
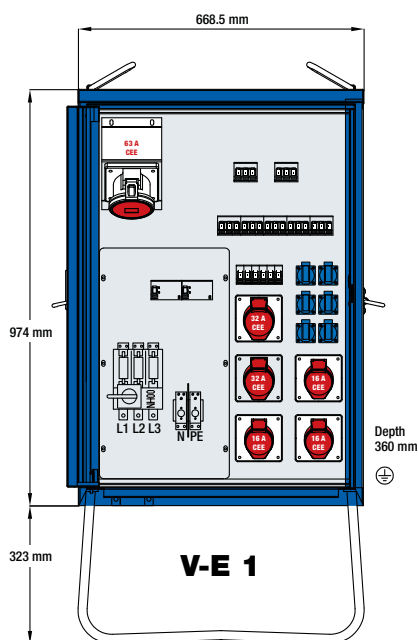

V-E 1 55 kVA

Input

Cable insertion M63 with strain relief up to max. 50 mm²

Connection protective device:
1x MCB 3P 80A
with thermal-magnetic trigger,
with box terminals 10-50 mm²

Output

1x CEE socket 400 V, 63 A, 5-pole
2x CEE sockets 400 V, 32 A, 5-pole
3x CEE sockets 400 V, 16 A, 5-pole
6x shock-proof socket outlets 230 V, 16 A



Output protective device

1x RCD 63 A, 4-pole, 300 mA, type B, all-current-sensitive
1x RCD 63 A, 4-pole, 30 mA, type B, all-current-sensitive
1x MCB D 63 A, 3-pole
1x MCB C 63 A, 3-pole
2x MCB C 32 A, 3-pole
3x MCB C 16 A, 3-pole
6x MCB C 16 A, 1-pole

V-E 2 44 kVA

Input

Cable insertion M63 with strain relief up to max. 50 mm²

Connection protective device:
1x MCB 3P 63A
with thermal-magnetic trigger,
with box terminals 10-50 mm²

Output

1x CEE socket 400 V, 32 A, 5-pole
2x CEE sockets 400 V, 16 A, 5-pole
6x shock-proof socket outlets 230 V, 16 A



Output protective device

1x RCD 63 A, 4-pole, 30 mA, type B, all-current-sensitive
1x RCD 40 A, 4-pole, 30 mA, type A, positive-current-sensitive
1x MCB C 32 A, 3-pole
2x MCB C 16 A, 3-pole
6x MCB C 16 A, 1-pole

DIN VDE 0100-704 standard amendment 2018:

Are up complying with the state of the art? We are.

As of 2020, the new standard must be complied with when a construction site is first set up or if any changes are made to the power combination unit while the construction site is in operation.

All of our construction site power combination units comply with user standard DIN VDE 0100-704. So you're always on the safe side.

Section 704.537.101 also states:

"Fixed connected construction site power combination units with sockets must contain devices for disconnecting the feed, which can be locked to prevent switch-on and which can be used by laypersons. A lockable cover is not sufficient".



Cables, sold by metre



- Approved for use on construction sites and in agricultural applications
- Flexible, with earth conductor with 5G
- Available by the metre (running metre) in your required length
- EU product



Heavy-duty rubber cable

RN

Version		Colour	PU	EAN	Art. no.
Running metre H07RN-F 4X 16	400 V, 63 A	Black	1	4011160100871	10087
Running metre H07RN-F 5G 16	400 V, 63 A	Black	1	4011160100505	10050
Running metre H07RN-F 4X 25	400 V, 125 A	Black	1	4011160100918	10091
Running metre H07RN-F 5G 25	400 V, 125 A	Black	1	4011160100758	10075
Running metre H07RN-F 4X 35	400 V, 125 A	Black	1	4011160100895	10089
Running metre H07RN-F 5G 35	400 V, 125 A	Black	1	4011160100765	10076

Earthing cables



- Approved for use on construction sites and in agricultural applications
- End 1: with eyelet A8 / 16 mm²
- End 2: with eyelet A10 / 16 mm²



Version	Colour	PU	EAN	Art. no.
3 m H07V-K 16	Green/yellow	1	4011160708695	70869

Earth terminal for earthing rod



- M8, simple
- For round conductors up to 10 mm in diameter

Version	PU	EAN	Art. no.
Earth terminal for earthing rod	1	4011160201172	20117

Earthing rod/cross-earther



- Made from hardened steel
- With eyelet in the head area (1x 13 mm diameter, 2x 11 mm diameter)
- Cross profile 50 x 50 x 3 mm

Version	PU	EAN	Art. no.
1.5 m tall earthing rod/cross-earther	1	4011160105104	10510
2 m tall earthing rod/cross-earther	1	4011160105098	10509

Solid rubber cable bridges



- Used to protect cables, hoses and pipes on the construction site.
- Cable bridges make it easier to cross the laid cables and help to prevent tripping accidents on the construction site
- Made from non-conductive and robust solid rubber in black/yellow signal colour
- Extremely non-slip surface thanks to the solid rubber material and the surface structure
- The material is UV-resistant and high-heat resistant, as well as resistant to acid and alkalis
- Very stable support on the surface thanks to the high tare weight of the cable bridges
- Suitable for being driven on by heavy-duty traffic of up to 9 t axle load, max. drive-over speed 10 km/h
- Simple connection system allows for unlimited extension of the cable bridges



**1 channel,
straight**

1 channel	Dimensions L x W x H (mm)	Channel size per channel (mm)	Connecting pin integrated	Weight (kg)	PU	EAN	Art. no.
Straight	1000 x 130 x 20	40 x 10	Yes	2	1	4011160632105	63210

Max. load capacity 200 kg, not suitable for heavy-duty traffic



**2 channel
MAXI, straight**

2 channel MAXI	Dimensions L x W x H (mm)	Channel size per channel (mm)	Connecting pin integrated	Weight (kg)	PU	EAN	Art. no.
Straight	800 x 590 x 105	80 x 80	Yes	27	1	4011160632242	63224



**2 channel,
straight**



**2 channel,
curved 30°**



**2 channel,
end piece**



**2 channel,
pin**

2 channel	Dimensions L x W x H (mm)	Channel size per channel (mm)	Connecting pin integrated	Weight (kg)	PU	EAN	Art. no.
Straight	1000 x 250 x 48	28 x 30	Yes	7.5	1	4011160632204	63220
Curve 30°	280 x 250 x 48	28 x 30	No, 2 pins 63223 are required per connection	1.9	1	4011160632211	63221
End piece	150 x 250 x 48	28 x 30	No, 2 pins 63223 are required per connection	2	1	4011160632228	63222
Pin	45 x 30 x 38			0.1	1	4011160632235	63223

NEW



Cable bridges



4 channel, straight



4 channel, curved 30°



4 channel, end piece



4 channel, pin



Installed cable bridge

4 channel	Dimensions L x W x H (mm)	Channel size per channel (mm)	Connecting pin integrated	Weight (kg)	PU	EAN	Art. no.
Straight	800 x 590 x 78	2 channels 52 x 52 2 channels 46 x 52	No, 2 pins 63243 are required per connection	23	1	4011160632402	63240
Curve 30°	455 x 590 x 78	2 channels 52 x 52 2 channels 46 x 52	No, 2 pins 63243 are required per connection	8.9	1	4011160632419	63241
End piece	300 x 590 x 78	2 channels 52 x 52 2 channels 46 x 52	No, 2 pins 63243 are required per connection	4.4	1	4011160632426	63242
Pin	105 x 47 x 50			0.2	1	4011160632433	63243



5 channel, straight



5 channel, curved 30°



5 channel, end piece



5 channel, pin

5 channel	Dimensions L x W x H (mm)	Channel size per channel (mm)	Connecting pin integrated	Weight (kg)	PU	EAN	Art. no.
Straight	800 x 445 x 50	35 x 35	Yes	15	1	4011160632501	63250
Curve 30°	380 x 445 x 50	35 x 35	Yes	4.8	1	4011160632518	63251
End piece	200 x 445 x 50	35 x 35	No, 2 pins 62353 are required per connection	4.4	1	4011160632525	63252
Pin	100 x 40 x 50			0.15	1	4011160632532	63253



Engraving service

Personalised labelling on your solid rubber construction site power combination units

Protect your solid rubber construction site power combination units from theft or from becoming mixed up when used on the construction site. This can easily be done by adding personalised labelling to the solid rubber housing of the construction site power combination unit. Our engraving service makes it possible. We can engrave your name and address on the surface of the housing, for example, thereby marking the construction site power combination unit as your property.

All solid rubber construction site power combination units M1 to M5 and all solid rubber multi socket outlets in the S series can be labelled to meet your specific requirements. Order your new construction site power combination unit with engraving now!

Technical details:

- Series M positioning: at the top on the lid
- Series S positioning: at the side on the housing
- Area being labelled: max. 150 x 50 mm
- 4 lines of text with max. 24 characters per line can be engraved
- Font: Arial, font size: 32 pt
- Engraving depth: approx. 0.5 mm

The outer edges of each letter are milled out.

Order your customised engraving now!

Art. no. 62000

Series M



Series S



NOT FOUND THE RIGHT VERSION?

Do you need a special version of a construction site power combination unit? We can make one-off productions to meet your specific requirements extremely quickly. Just get in touch.

Portable CEE construction site power combination units made from solid rubber



You can find the right versions for any application on the following pages.

Solid rubber power combination units are specially designed for **harsh construction site use**.

They are characterised by their outstanding **quality, dimensional stability and durability**. They are of particular use in areas with extreme **mechanical and/or chemical loads**: aggressive acids or cleaning agents, high mechanical forces, wide range of temperature conditions or similar. Even **heavy impacts** do not affect the shape or function of the units.

Plug systems **from different European countries** can be used without any problems. **Just get in touch.**

Portable solid rubber CEE construction site power combination unit series M



Technical data

- Extremely sturdy solid rubber housing, stackable for extremely space-saving storage
- Closed lower section of housing with 77 mm ground clearance to prevent water ingress
- Easy switching of the panel-mounted sockets
- Housing lid with stainless steel quick fastenings
- Touch-safe even when the lid is open – in accordance with BGV [German trade association provisions] A2
- Fuses are particularly well-protected due to their internal installation
- Additional safety can be achieved with an optional screw or padlock
- Tested in accordance with DIN VDE 0620-2-1, IEC 60309, EN 61439-4, DIN EN 50525-2
- **IP44**: protected against foreign bodies and splash-proof



M1 Input **16 A**, approx. 11 kW Output



Device plug connection
CEE 400 V, 16 A, 5-pole

4x shock-proof socket outlets 230 V, 16 A
2x CEE sockets 400 V, 16 A, 5-pole



Protection

1x RCD 40 A, 4-pole, 30 mA, type A

EAN 4011160605505
Art. no. 60550



M2 Input **32 A**, approx. 22 kW Output



CEE plug
400 V, 32 A, 5-pole
with 2 m H07RN-F 5G6
heavy-duty rubber cable

4x shock-proof socket outlets 230 V, 16 A
2x CEE sockets 400 V, 16 A, 5-pole
1x CEE socket 400 V, 32 A, 5-pole



Protection

2x circuit breaker C 16 A, 1-pole
2x circuit breaker C 16 A, 3-pole

EAN 4011160605529
Art. no. 60552



M3 Input **32 A**, approx. 22 kW Output



CEE plug
400 V, 32 A, 5-pole
with 2 m H07RN-F 5G6
heavy-duty rubber cable

4x shock-proof socket outlets 230 V, 16 A
1x CEE socket 400 V, 16 A, 5-pole
1x CEE socket 400 V, 32 A, 5-pole



Protection

1x RCD 40 A, 4-pole, 30 mA, type A
2x circuit breaker C 16 A, 1-pole
1x circuit breaker C 16 A, 3-pole

EAN 4011160605543
Art. no. 60554



M4 Input **32 A**, approx. 22 kW Output



CEE plug
400 V, 32 A, 5-pole
with 2 m H07RN-F 5G6
heavy-duty rubber cable

3x shock-proof socket outlets 230 V, 16 A
2x CEE sockets 400 V, 16 A, 5-pole
1x CEE socket 400 V, 32 A, 5-pole



Protection

1x RCD 40 A, 4-pole, 30 mA, type A
3x circuit breaker C 16 A, 1-pole
1x circuit breaker C 16 A, 3-pole

EAN 4011160605550
Art. no. 60555



M5 Input **32 A**, approx. 22 kW Output



CEE plug
400 V, 32 A, 5-pole
with 2 m H07RN-F 5G6
heavy-duty rubber cable

3x shock-proof socket outlets 230 V, 16 A
1x CEE socket 400 V, 16 A, 5-pole
2x CEE sockets 400 V, 32 A, 5-pole



Protection

1x RCD 40 A, 4-pole, 30 mA, type A
3x circuit breaker C 16 A, 1-pole
1x circuit breaker C 16 A, 3-pole

EAN 4011160605512
Art. no. 60551



Portable CEE construction site power combination units Series M



Versions with **all-current sensitive RCD type B** available on request.

M6 Input 63 A, approx. 43 kW Output



CEE plug
400 V, 63 A, 5-pole
with 2 m H07RN-F 5G16
heavy-duty rubber cable

3x shock-proof socket outlets 230 V, 16 A
3x CEE sockets 400 V, 16 A, 5-pole
3x CEE sockets 400 V, 32 A, 5-pole



Protection

1x RCD 63 A, 4-pole, 30 mA, type A
3x circuit breaker C 32 A, 3-pole
3x circuit breaker C 16 A, 3-pole
2x circuit breaker C 16 A, 1-pole

EAN 4011160605611

Art. no. 60561



M63 Input 63 A, approx. 43 kW Output



CEE plug
400 V, 63 A, 5-pole
with 2 m H07RN-F 5G16
heavy-duty rubber cable

3x shock-proof socket outlets 230 V, 16 A
2x CEE sockets 400 V, 16 A, 5-pole
1x CEE socket 400 V, 32 A, 5-pole
1x CEE socket 400 V, 63 A, 5-pole



Protection

1x RCD 63 A, 4-pole, 30 mA, type A
1x circuit breaker C 32 A, 3-pole
2x circuit breaker C 16 A, 3-pole
3x circuit breaker C 16 A, 1-pole

EAN 4011160615627

Art. no. 61562



Multi socket outlets Series S

with solid rubber housing



NOT FOUND THE RIGHT VERSION?

We can make CEE multi socket outlets to meet your specific requirements extremely quickly. Just get in touch!

Solid rubber multi socket outlets series S



Technical data



- Housing made from extremely robust solid rubber
- Versions with various inputs and outputs for heavy-duty construction site use
- Tested in accordance with DIN VDE 0620-2-1, IEC 60309, EN 61439-4, DIN EN 50525-2
- **IP44**: protected against foreign bodies and splash-proof



S1	Input 16 A, approx. 3.6 kW	Output	Protection	 EAN 4011160605567 Art. no. 60556
	Solid rubber shock-proof plug 230 V, 16 A with 2 m H07RN-F 3G2.5 heavy-duty rubber cable	6x shock-proof socket outlets 230 V, 16 A 	None	

S1+	Input 16 A, approx. 3.6 kW	Output	Protection	 EAN 4011160608124 Art. no. 60812
	Solid rubber shock-proof plug 230 V, 16 A with 2 m H07RN-F 3G2.5 heavy-duty rubber cable	6x shock-proof socket outlets 230 V, 16 A 	1x RCD 25 A, 2-pole, 30 mA, type A	

S2	Input 16 A, approx. 11 kW	Output	Protection	 EAN 4011160608544 Art. no. 60854
	CEE plug 400 V, 16 A, 5-pole with 2 m H07RN-F 5G2.5 heavy-duty rubber cable	6x shock-proof socket outlets 230 V, 16 A 	None	

S2+	Input 16 A, approx. 11 kW	Output	Protection	 EAN 4011160608094 Art. no. 60809
	CEE plug 400 V, 16 A, 5-pole with 2 m H07RN-F 5G2.5 heavy-duty rubber cable	6x shock-proof socket outlets 230 V, 16 A 	1x RCD 40 A, 4-pole, 30 mA, Type A	

S3	Input 16 A, approx. 11 kW	Output	Protection	 EAN 4011160605574 Art. no. 60557
	CEE plug 400 V, 16 A, 5-pole with 2 m H07RN-F 5G2.5 heavy-duty rubber cable	3x shock-proof socket outlets 230 V, 16 A 1x CEE socket 400 V, 16 A, 5-pole 	None	

Solid rubber multi socket outlets series S



Technical data

- Housing made from extremely robust solid rubber
- Versions with various inputs and outputs for heavy-duty construction site use
- Tested in accordance with DIN VDE 0620-2-1, IEC 60309, EN 61439-4, DIN EN 50525-2
- **IP44**: protected against foreign bodies and splash-proof



S4

Input **16 A**, approx. 11 kW

Output

Protection



CEE plug 400 V, 16 A, 5-pole
with 2 m H07RN-F 5G2.5
heavy-duty rubber cable

3x shock-proof socket outlets 230 V, 16 A
2x CEE sockets 400 V, 16 A, 5-pole



None



EAN 4011160605604
Art. no. 60560

S5+

Input **16 A**, approx. 11 kW

Output

Protection



CEE plug 400 V, 16 A, 5-pole
with 2 m H07RN-F 5G2.5
heavy-duty rubber cable

2x shock-proof socket outlets 230 V, 16 A
2x CEE sockets 400 V, 16 A, 5-pole



1x RCD 40 A, 4-pole,
30 mA, Type A



EAN 4011160608049
Art. no. 60804

S6

Input **16 A**, approx. 11 kW

Output

Protection



CEE plug 400 V, 16 A, 5-pole
with 2 m H07RN-F 5G2.5
heavy-duty rubber cable

3x CEE sockets 400 V, 16 A, 5-pole



None



EAN 4011160605581
Art. no. 60558

S10+

Input **32 A**, approx. 22 kW

Output

Protection



CEE plug 400 V, 32 A, 5-pole
with 2 m H07RN-F 5G6
heavy-duty rubber cable

2x CEE sockets 400 V, 16 A, 5-pole



2x MCB C 16 A,
3-pole



EAN 4011160608063
Art. no. 60806

S11+

Input **32 A**, approx. 22 kW

Output

Protection



CEE plug 400 V, 32 A, 5-pole
with 2 m H07RN-F 5G6
heavy-duty rubber cable

3x shock-proof socket outlets 230 V, 16 A
1x CEE socket 400 V, 16 A, 5-pole
1x CEE socket 400 V, 32 A, 5-pole



1x MCB C 16 A,
3-pole
1x MCB C 16 A,
1-pole



EAN 4011160608131
Art. no. 60813

Multi socket outlets Series S

with solid rubber housing



NOT FOUND THE RIGHT VERSION?

We can make CEE multi socket outlets to meet your specific requirements extremely quickly. Just get in touch!

S20+

Input **63 A**, approx. 43 kW



CEE plug 400 V, 63 A, 5-pole
with 2 m H07RN-F 5G16
heavy-duty rubber cable

Output

2x CEE sockets 400 V, 32 A, 5-pole



Protection

2x MCB C 32 A,
3-pole



EAN 4011160608070
Art. no. 60807

S21+

Input **63 A**, approx. 43 kW



CEE plug 400 V, 63 A, 5-pole
with 2 m H07RN-F 5G16
heavy-duty rubber cable

Output

1x CEE socket 400 V, 63 A, 5-pole



Protection

1x RCD 63 A, 4-pole,
300 mA
all-current-sensitive
RCD type B



EAN 4011160608148
Art. no. 60814

MIXO CEE adapter 16 A



Technical data

- Robust housing made from shatterproof special plastic and space-saving construction
- Wide range of versions for various portable applications on the construction site
- Tested in accordance with DIN VDE 0620-2-1, IEC 60309 and RN-F tested in accordance with DIN EN 50525-2
- **IP44**: protected against foreign bodies and splash-proof



Adapter plug

Input **16 A**, approx. 11 kW

Output

Protection



CEE plug 400 V, 16 A, 5-pole

1x shock-proof socket outlet 230 V, 16 A

None



EAN 4011160604959
Art. no. 60495

MIXO SAAR

Input **16 A**, approx. 11 kW

Output

Protection



CEE plug 400 V, 16 A, 5-pole

3x shock-proof socket outlets 230 V, 16 A
(one socket per phase)

None



EAN 4011160605246
Art. no. 60524

MIXO NAGOLD

Input **16 A**, approx. 11 kW

Output

Protection



CEE plug 400 V, 16 A, 5-pole
with 1.5 m H07RN-F 5G1.5
heavy-duty rubber cable

3x shock-proof socket outlets 230 V, 16 A
(one socket per phase)

None



EAN 4011160605277
Art. no. 60527

MIXO BRIGACH

Input **16 A**, approx. 11 kW

Output

Protection



CEE plug 400 V, 16 A, 5-pole

3x shock-proof socket outlets 230 V, 16 A
(one socket per phase)
1x CEE socket 400 V, 16 A, 5-pole

None



EAN 4011160605208
Art. no. 60520

MIXO ENZ

Input **16 A**, approx. 11 kW

Output

Protection



CEE plug 400 V, 16 A, 5-pole
with 2 m H07RN-F 5G2.5
heavy-duty rubber cable

3x shock-proof socket outlets 230 V, 16 A
(one socket per phase)
1x CEE socket 400 V, 16 A, 5-pole

None



EAN 4011160615207
Art. no. 61520



MIXO CEE adapter 16 A

MIXO ISAR

Input **16 A**, approx. 11 kW

Output

Protection



CEE plug 400 V, 16 A, 5-pole

1x CEE socket 400 V, 16 A, 5-pole

1x RCD 40 A, 4-pole, 30 mA, type A



EAN 4011160617089
Art. no. 61708

MIXO WERRA

Input **16 A**, approx. 11 kW

Output

Protection



CEE plug 400 V, 16 A, 5-pole with 1.5 m H07RN-F 5G2.5 heavy-duty rubber cable

1x CEE socket 400 V, 16 A, 5-pole

1x RCD 40 A, 4-pole, 30 mA, Type A



EAN 4011160617058
Art. no. 61705

MIXO RHEIN

Input **16 A**, approx. 11 kW

Output

Protection



CEE plug 400 V, 16 A, 5-pole

3x CEE sockets 400 V, 16 A, 5-pole

None



EAN 4011160605314
Art. no. 60531

MIXO NECKAR

Input **16 A**, approx. 11 kW

Output

Protection



CEE plug 400 V, 16 A, 5-pole with 1.5 m H07RN-F 5G1.5 heavy-duty rubber cable

3x CEE sockets 400 V, 16 A, 5-pole

None



EAN 4011160605260
Art. no. 60526

MIXO MAIN

Input **16 A**, approx. 11 kW

Output

Protection



CEE plug 400 V, 16 A, 5-pole

1x CEE socket 400 V, 32 A, 5-pole

None



EAN 4011160605307
Art. no. 60530

MIXO DONAU

Input **16 A**, approx. 11 kW

Output

Protection



CEE plug 400 V, 16 A, 5-pole

2x shock-proof socket outlets 230 V, 16 A
1x CEE socket 400 V, 16 A, 5-pole
1x CEE socket 400 V, 32 A, 5-pole

None



EAN 4011160605222
Art. no. 60522

MIXO CEE adapter 32 A



Technical data

- Robust housing made from shatterproof special plastic and space-saving construction
- Wide range of versions for various portable applications on the construction site
- Tested in accordance with DIN VDE 0620-2-1, IEC 60309 and RN-F tested in accordance with DIN EN 50525-2
- **IP44**: protected against foreign bodies and splash-proof



MIXO RUHR

Input **32 A**, approx. 7 kW

Output

Protection



CEE plug 400 V, 32 A, 5-pole

1x shock-proof socket outlet 230 V, 16 A
2x CEE sockets 400 V, 16 A, 5-pole



3x G-fuses (10 A)
non-resetting,
time-delay T10A SPT 5x20 mm,
Please note: only loadable up to 7 kW



EAN 4011160608339

Art. no. 60833

MIXO MOSEL

Input **32 A**, approx. 7 kW

Output

Protection



CEE plug 400 V, 32 A, 5-pole

1x shock-proof socket outlet 230 V, 16 A
1x CEE socket 400 V, 16 A, 5-pole
1x CEE socket 400 V, 32 A, 5-pole



3x G-fuses (10 A)
non-resetting,
time-delay T10A SPT 5x20 mm,
Please note: only loadable up to 7 kW
(16 A sockets)



EAN 4011160605253

Art. no. 60525

MIXO NAHE

Input **32 A**, approx. 11 kW

Output

Protection



CEE plug 400 V, 32 A, 5-pole

1x CEE socket 400 V, 16 A, 5-pole



1x MCB C 16 A, 3-pole
Resettable



EAN 4011160607035

Art. no. 60703

MIXO SPREE

Input **32 A**, approx. 11 kW

Output

Protection



CEE plug 400 V, 32 A, 5-pole
with 1.5 m H07RN-F 5G2.5
heavy-duty rubber cable

1x CEE socket 400 V, 16 A, 5-pole



1x MCB C 16 A, 3-pole
Resettable



EAN 4011160607042

Art. no. 60704

MIXO ELBE

Input **32 A**, approx. 22 kW

Output

Protection



CEE plug 400 V, 32 A, 5-pole

3x CEE sockets 400 V, 32 A, 5-pole



None



EAN 4011160608322

Art. no. 60832

MIXO CEE adapters 32 A



MIXO ODER

Input **32 A**, approx. 22 kW

Output

Protection



CEE plug 400 V, 32 A, 5-pole
with 1.5 m H07RN-F 5G4
heavy-duty rubber cable

3x CEE sockets 400 V, 32 A, 5-pole



None

EAN 4011160605291
Art. no. 60529

MIXO HAVEL

Input **32 A**, approx. 22 kW

Output

Protection



CEE plug 400 V, 32 A, 5-pole

1x CEE socket 400 V, 32 A, 5-pole



1x RCD 40 A, 4-pole, 30 mA,
type A

EAN 4011160617072
Art. no. 61707

NEW

MIXO FULDA

Input **32 A**, approx. 22 kW

Output

Protection



CEE plug 400 V, 32 A, 5-pole
with 1.5 m H07RN-F 5G6
heavy-duty rubber cable

1x CEE socket 400 V, 32 A, 5-pole



1x RCD 40 A, 4-pole,
30 mA, type A

EAN 4011160617065
Art. no. 61706

NEW

Overview of model details:



Large carry handle, perfect for gripping with gloves

STECKY

Housing made of special plastic highly shock resistant



Powder-coated metal frame with edge protection

Cord made of heavy-duty rubber H07RN-F from 3G2.5 up to 5G6

STECKY DUO

Stable metal foot with cable re-winder



Velcro fastener for fixing the cord to the frame



STECKY DUO with phase display



STECKY DUO with 2 USB ports to recharge mobile phones, handlamp batteries etc.



STECKY



STECKY DUO

STECKY



CEE combination units



The STECKY range includes various combination units from 3.5 to 22 kW. Depending on the model, up to twelve outlets such as shock-proof sockets, USB ports or CEE sockets are available. All models of the STECKY range are intended for indoor, permanent outdoor and construction site use. Integrated protection devices avoid accidents.





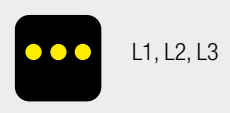

Input/plug

-  CEE plug
230 V, 16 A, 3-pole
-  CEE plug
400 V, 16 A, 5-pole
-  CEE plug
400 V, 32 A, 5-pole

Phase display



Output/socket

-  Shock-proof socket outlet
German standard
230 V, 16 A
-  CEE socket
230 V, 16 A, 3-pole
-  CEE socket
400 V, 16 A, 5-pole
-  CEE socket
400 V, 32 A, 5-pole
-  2 USB ports
5 V/2.1 A

Protection



FI/RCD
RCD 40 A/30 mA, 4-pole, type A
RCBO 25 A/30 mA, 2-pole, C curve, type A



C16A
MCB 16 A, 3-pole, type C
MCB 16 A, 1-pole, type C





STECKY

CEE combination units

STECKY CEE combination units



Technical data

- Housing made of special plastic highly shock-resistant
- Powder-coated metal frame with edge protection
- Ergonomic handle and cable re-winder
- Dimensions (W x H x D): 230 x 417 x 220 mm
- Tested in accordance with DIN VDE 0620-2-1, IEC 60309, EN 61439-4, DIN EN 50525-2
- **IP44:** splash-proof

STECKY 11

Input **16 A**, approx. 11 kW

Output

Protection



CEE plug 400 V, 16 A, 5-pole with 2.5 m H07RN-F 5G2.5 heavy-duty rubber cable

4x shock-proof socket outlets 230 V, 16 A, 2 PE
2x CEE sockets 400 V, 16 A, 5-pole

None



EAN 4011160609602
Art. no. 60960

STECKY 11+

Input **16 A**, approx. 11 kW

Output

Protection



CEE plug 400 V, 16 A, 5-pole with 2.5 m H07RN-F 5G2.5 heavy-duty rubber cable

4x shock-proof socket outlets 230 V, 16 A, 2 PE
2x CEE sockets 400 V, 16 A, 5-pole

1x RCD 40 A, 30 mA, type A



FI/RCD



EAN 4011160609619
Art. no. 60961

STECKY 12

Input **32 A**, approx. 22 kW

Output

Protection



CEE plug 400 V, 32 A, 5-pole with 4.5 m H07RN-F 5G4 heavy-duty rubber cable

4x shock-proof socket outlets 230 V, 16 A, 2 PE
1x CEE socket 400 V, 16 A, 5-pole
1x CEE socket 400 V, 32 A, 5-pole

1x MCB C 16 A, 3-pole
2x MCB C 16 A, 1-pole



C16A



EAN 4011160609626
Art. no. 60962

STECKY 13

Input **32 A**, approx. 22 kW

Output

Protection



CEE plug 400 V, 32 A, 5-pole with 4.5 m H07RN-F 5G4 heavy-duty rubber cable

4x shock-proof socket outlets 230 V, 16 A (2 PE)
1x CEE socket 400 V, 16 A, 5-pole
1x CEE socket 400 V, 32 A, 5-pole

1x RCD 40 A, 30 mA, type A
1x MCB C 16 A, 3-pole
2x MCB C 16 A, 1-pole



FI/RCD



C16A



EAN 4011160609633
Art. no. 60963



STECKY DUO

CEE combination units

STECKY CEE combination units



Technical data

- Housing made of special plastic highly shock-resistant
- Powder-coated metal frame with edge protection
- Ergonomic handle and cable rewinder
- Dimensions (W x H x D): 400 x 450 x 252 mm
- Tested in accordance with DIN VDE 0620-2-1, IEC 60309, EN 61439-4, DIN EN 50525-2
- **IP44**: splash-proof

NEW



STECKY DUO 1

Input **16 A**, approx. 11 kW



CEE plug 400 V, 16 A, 5-pole
with 3.4 m H07RN-F 5G2.5
heavy-duty rubber cable

Output

8x shock-proof socket outlets 230 V, 16 A,
(2 PE)

4x CEE sockets 400 V, 16 A, 5-pole



Protection

1x RCD 40 A, 30 mA, type A



FI/RCD



EAN 4011160609312
Art. no. 60931

STECKY DUO 2

Input **16 A**, approx. 11 kW



CEE plug 400 V, 16 A, 5-pole
with 3.4 m H07RN-F 5G2.5
heavy-duty rubber cable

Output

8x shock-proof socket outlets 230 V, 16 A,
(2 PE)

2x CEE sockets 400 V, 16 A, 5-pole

2x USB ports 5 V / 2.1 A

Phase display L1, L2, L3



Protection

1x RCD 40 A, 30 mA, type A



FI/RCD



EAN 4011160609329
Art. no. 60932

STECKY DUO 3

Input **32 A**, approx. 22 kW



CEE plug 400 V, 32 A, 5-pole
with 2.1 m H07RN-F 5G6
heavy-duty rubber cable

Output

6x shock-proof socket outlets 230 V, 16 A,
(2 PE)

2x CEE sockets 400 V, 16 A, 5-pole

2x CEE sockets 400 V, 32 A, 5-pole

2x USB ports 5 V / 2.1 A

Phase display L1, L2, L3



Protection

1x RCD 40 A, 30 mA, type A

1x MCB C 16 A, 3-pole

3x MCB C 16 A, 1-pole



FI/RCD C16A



EAN 4011160609336
Art. no. 60933

STECKY DUO 4

Input **32 A**, approx. 22 kW



CEE plug 400 V, 32 A, 5-pole
with 3.4 m H07RN-F 5G6
heavy-duty rubber cable

Output

6x shock-proof socket outlets 230 V, 16 A,
(2 PE)

1x CEE socket 230 V, 16 A, 3-pole

1x CEE socket 400 V, 16 A, 5-pole

2x CEE sockets 400 V, 32 A, 5-pole

2x USB ports 5 V / 2.1 A

Phase display L1, L2, L3

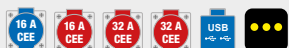

Protection

1x RCD 40 A, 30 mA, type A

1x MCB C 16 A, 3-pole

4x MCB C 16 A, 1-pole



FI/RCD C16A



EAN 4011160609343
Art. no. 60934

FIXO CEE combination units

Perfectly suited to wall attachment thanks to the flat construction.

Frame also allows for mobile use.



FIXO I
400 V



FIXO I
with frame



FIXO II
400 V



FIXO III
400 V



FIXO IV
230 V



FIXO frame

- Mobile frame to fit all FIXO models

Version	Weight	PU	EAN	Art. no.
FIXO frame	2.4 kg	1	4011160104695	10469

FIXO CEE combination units



Technical data

- Robust housing made from shatterproof special plastic, including carry handle
- Perfectly suited to wall attachment thanks to the flat construction
- Optional matching frame available for portable use
- Tested in accordance with DIN VDE 0620-2-1, IEC 60309, EN 61439-4, DIN EN 50525-2
- **IP44**: protected against foreign bodies and splash-proof



FIXO CEE combination units

IP44

FIXO I

Input **32 A**, approx. 22 kW



CEE plug 400 V, 32 A, 5-pole

Output

4x shock-proof socket outlets 230 V, 16 A
1x CEE socket 400 V, 16 A, 5-pole
1x CEE socket 400 V, 32 A, 5-pole



Protection

1x RCD 40 A, 4-pole, 30 mA, type A
1x MCB C 16 A, 3-pole
2x MCB C 16 A, 1-pole



EAN 4011160605116
Art. no. 60511

FIXO II

Input **16 A**, approx. 11 kW



CEE plug 400 V, 16 A, 5-pole

Output

6x shock-proof socket outlets 230 V, 16 A
2x CEE sockets 400 V, 16 A, 5-pole



Protection

1x RCD 40 A, 4-pole, 30 mA, type A
3x MCB B 16 A, 1-pole



EAN 4011160605093
Art. no. 60509

FIXO III

Input **32 A**, approx. 22 kW



CEE plug 400 V, 32 A, 5-pole

Output

4x shock-proof socket outlets 230 V, 16 A
2x CEE sockets 400 V, 16 A, 5-pole



Protection

1x RCD 40 A, 4-pole, 30 mA, type A
2x MCB C 16 A, 3-pole
2x MCB C 16 A, 1-pole



EAN 4011160605161
Art. no. 60516

FIXO IV

Market combination unit

Input **16 A**, approx. 3.5 kW



CEE plug 230 V, 16 A, 3-pole
5 m H07RN-F 3G2,5 heavy-duty rubber cable

Output

6x shock-proof socket outlets 230 V, 16 A
1x CEE socket 230 V, 16 A, 3-pole



Protection

1x RCD 25 A, 2-pole, 30 mA, type A
3x MCB B 16 A, 1-pole



EAN 4011160605239
Art. no. 60523



9



LED working lamps **140-145**

LED floodlights **146-149**

Tripods **150-151**

Optiline **152-153**

Acculine Flex **154**

Solarline **155**

Handlamps and headlamps **156-163**

Oval and round lights **164-165**

Halogen floodlights **166**

Energy-saving lights **167**

Large-area floodlights **168-171**

Lighting

LICHTFABRIK

Handlamps and headlamps
can be found from page 156.

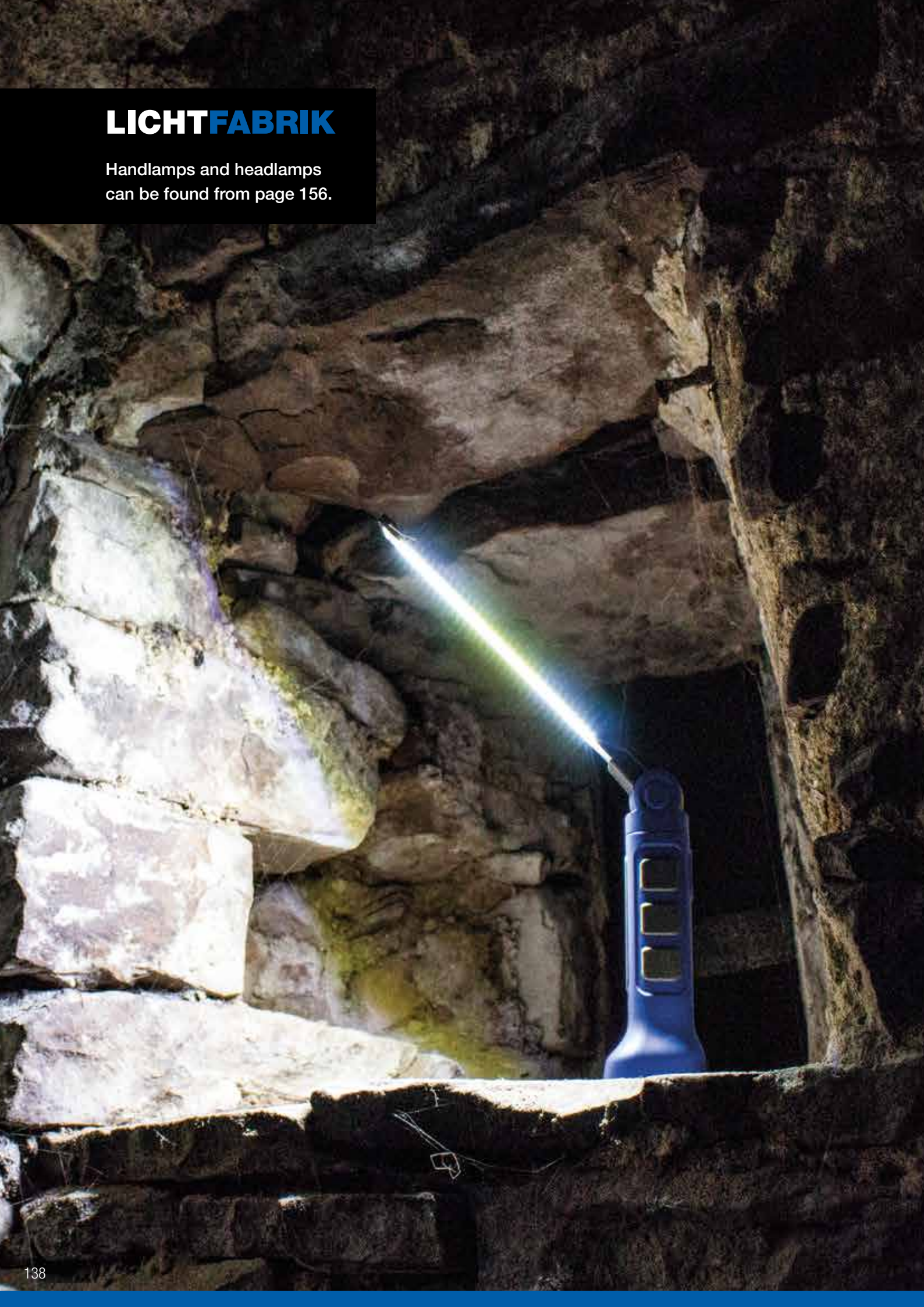

Working lamps

Lumen overview

Lamps up to 20,000 lumen

Halogen lamps						400 W 8,600 lm	1,000 W 18,000 lm
Chip LED lamps	10 W 850 lm	20 W 1,700 lm	30 W 2,550 lm	50 W 4,250 lm	80 W 6,800 lm	120 W 10,200 lm	200 W 17,000 lm
Energy-saving lamps			38 W 2,700 lm	72 W 5,900 lm			

Lamps up to 200,000 lumen

Halogen lamps		1,500 W 26,000 lm	2,000 W 35,000 lm	
Energyline XL lamps		XL 180 W 25,200 lm	XL 540 W 75,600 lm	XL 1,080 W 151,200 lm
HQI lamps		400 W 35,000 lm	1,000 W 85,000 lm	2,000 W 200,000 lm

Crossline LED working lamps

With battery/hybrid or charger



Shock-resistant,
rubber edge protection



Specially designed aluminium
heat exchanger to extend the
LED lifespan



Stepless on/off
dimmer of 0-100 %



Adjustable foot,
easy assembly on tripods



Cable retractor with
cord 5 m
H07RN-F 3G1.5



2 socket outlets with flap lids,
splash-proof



USB output (5 V/1 A) for charging your
smartphone, MP3 player etc.



Battery level indicator



410 mm

LED working lamps



Technical data

- Specially developed **ORIGINAL SAMSUNG SMD LED**: nominal lifetime over 50000 hours
- Reinforced high-quality plastic housing with a polycarbonate front plate to reduce drop shadows
- Diagonal length: 410 mm
- LED beam angle: 120°
- Input voltage/frequency: 230 V/50-60 Hz
- Tested in accordance with DIN EN 60598-1
- **IP54**: protected against dust and splash-proof

Stepless dimming in 3 colour temperatures



5700 K
daylight

4000 K
neutral white

2700 K
warm white

Crossline LED working lamps

with original **SAMSUNG LED IP54**



Model 50 W battery/hybrid (46885)

- Light performances up to 6500 lumen depending on the dimmer setup and colour temperature
- Li-ion battery 15 V/10500 mAh
- Charging time: approx. 4 hours with battery level indicator
- Max. operating time: approx. 3 to 9 hours (depending on dimmer setup)
- Hybrid function: power charger for simultaneous charging and permanent operation
- Includes 1.5 m vehicle charging cable 5 A**/12 V (** please note efficiency of the car cigarette lighter)
- Weight with charging cable: 5.2 kg
- USB output (5 V/1 A) for charging your smartphone, MP3 player etc.



Model 80 W with 5 m H07RN-F 3G1.5 (46888)

- Light performances up to 10400 lumen depending on the dimmer setup and colour temperature
- 2 splash-proof socket outlets, 16 A / 250 V / IP54
- Cable rewinder with cord 5 m H07RN-F 3G1.5
- Weight with cable: 4.5 kg

Model	Luminous flux	Colour temperature	PU	EAN	Art. no.
50 watt	Up to 6500 lumen	2700 K (warm white), 4000 K (neutral white), 5700 K (daylight)	1	4011160468858	46885
80 watt	Up to 10400 lumen	2700 K (warm white), 4000 K (neutral white), 5700 K (daylight)	1	4011160468889	46888



LED technology

LEDs are tiny electronic chips made from special **semi-conductor compounds**. When current flows through this solid body, it starts to glow; to “emit” light. In lighting technology, this process is called “electroluminescence”. With an edge length of approx. 1 mm, LEDs are among the **smallest available light sources**. They emit a nearly **punctiform light**. Just a **small amount of energy** is sufficient to light up the semi-conductor.

Benefits of LED lighting:

- ✓ Energy efficiency of 80 % to 90 % when compared to traditional lighting
- ✓ Instant lighting: LED lights brighten up immediately when powered on
- ✓ Low power consumption of LEDs leads to significant energy savings
- ✓ Extended life: Quality LEDs have a nominal lifetime of up to 50000 hours
- ✓ Ecologically friendly: LED lights are free of toxic chemicals like e.g. mercury

Latest **SAMSUNG CHIP LED** technology



- **Less light loss:** conventional LEDs lose 5 % of their luminous flux within 3 months
- **More effective LEDs:** increased luminous flux with lower consumption
- **Excellent thermal properties:** longer operating time compared to other LEDs
- **Range from 10 to 240 W**

Mobile CHIP LED floodlights



Technical data

- Specially developed **ORIGINAL SAMSUNG SMD LED**: nominal lifetime of over 50000 hours
- Reinforced die-cast aluminium housing in modern design
- LED beam angle: 120°
- Input voltage/frequency: 230 V/50-60 Hz
- Tested in accordance with DIN EN 60598-1



Slimline foldable CHIP LED floodlight

with original SAMSUNG LED **IP65**



- Foldable frame and replaceable safety glass
- 2 m rubber power cable H05RN-F 3G1.0 with shock-proof plug
- **IP65**: dust-tight and jet-water-proof

Model	Luminous flux	Colour temperature	PU	EAN	Art. no.
10 watt	Approx. 850 lumen	4000 K (neutral white)	1	4011160464102	46410



Slimline mobile CHIP LED floodlight

with original SAMSUNG LED **IP44/IP65**



- Stable frame with plastic handle
- Robust protective grille and replaceable safety glass
- Adjusting screw with large, handle star grip
- 2 m rubber power cable H05RN-F 3G1.0
- With safety plug
- **IP65**: dust-tight and splash-proof

Model	Luminous flux	Colour temperature	PU	EAN	Art. no.
20 watt	Approx. 1700 lumen	4000 K (neutral white)	1	4011160464263	46426



- 3 m rubber power cable H07RN-F 3G1.5
- With safety plug
- Includes 2 shock-proof socket outlets with flap lids on the back
- **IP44**: protected against foreign bodies and splash-proof

Model	Luminous flux	Colour temperature	PU	EAN	Art. no.
50 watt	Approx. 4250 lumen	4000 K (neutral white)	1	4011160464294	46429
80 watt	Approx. 6800 lumen	4000 K (neutral white)	1	4011160464287	46428





CHIP LED floodlights on tripod



Technical data

- Specially developed **ORIGINAL SAMSUNG SMD LED**: nominal lifetime of over 50000 hours
- Reinforced die-cast aluminium housing in a modern design
- Robust protective grille and replaceable safety glass
- 5 m rubber power cable H05RN-F 3G1.0 with shock-proof plug
- LED beam angle: 120°
- Input voltage/frequency: 230 V/50 – 60 Hz
- **IP65**: dust-tight and jet-water-proof
- Tested in accordance with DIN EN 60598-1



Slimline CHIP LED floodlight on tripod

with original **SAMSUNG LED IP65**

- Maximum height: 1.6 m
- Optionally available with robust case for simple, secure transportation



Model	Luminous flux	Colour temperature	PU	EAN	Art. no.
30 watt	Approx. 2550 lumen	4000 K (neutral white)	1	4011160464034	46403
30 watt in transport case	Approx. 2550 lumen	4000 K (neutral white)	1	4011160464041	46404



- Maximum height: 1.8 m



Model	Luminous flux	Colour temperature	PU	EAN	Art. no.
2 x 30 watt	Approx. 5100 lumen	4000 K (neutral white)	1	4011160464096	46409



Chip LED floodlight



Technical data

- Specially developed **ORIGINAL SAMSUNG SMD LED**: nominal lifetime of over 50000 hours
- Extremely slimline, reinforced die-cast aluminium housing in a modern design
- Lockable, swivelling floodlight
- Replaceable safety glass
- LED beam angle: 120°
- Input voltage/frequency: 230 V/50-60 Hz
- Tested in accordance with DIN EN 60598-1
- **IP65**: dust-tight and jet-water-proof

Slimline Chip LED floodlight

with original SAMSUNG LED IP65



- No power cord, cable insertion for cables up to 3G1.5

Model	Luminous flux	Colour temperature	PU	EAN	Art. no.
10 watt	Approx. 850 lumen	4000 K (neutral white)	1	4011160464157	46415

- 2 m rubber power cable H05RN-F 3G1.0 with shock-proof plug



Model	Luminous flux	Colour temperature	PU	EAN	Art. no.
20 watt	Approx. 1700 lumen	4000 K (neutral white)	1	4011160464256	46425
50 watt	Approx. 4250 lumen	4000 K (neutral white)	1	4011160464058	46405



- 2 m rubber power cable H07RN-F 3G1.5 with shock-proof plug



Model	Luminous flux	Colour temperature	PU	EAN	Art. no.
80 watt	Approx. 6800 lumen	4000 K (neutral white)	1	4011160464805	46480
120 watt	Approx. 10200 lumen	4000 K (neutral white)	1	4011160464652	46465



Chip LED floodlight

with original SAMSUNG LED IP65



- Large, solid die-cast aluminium housing
- 2 m rubber power cable H07RN-F 3G1.5 with shock-proof plug

Model	Luminous flux	Colour temperature	PU	EAN	Art. no.
200 watt	Approx. 17000 lumen	4000 K (neutral white)	1	4011160469862	46986



Chip LED floodlight with motion detector



Technical data

- Input voltage/frequency: 230 V/50-60 Hz
- Tested in accordance with DIN EN 60598-1
- **IP44:** protected against foreign bodies and splash-proof

Slimline Chip LED floodlight with motion detector

with original SAMSUNG LED IP44



Motion detector



- Specially developed ORIGINAL SAMSUNG SMD LED: nominal lifetime of over 50000 hours
- Extremely slimline, reinforced die-cast aluminium housing in a modern design
- Lockable, swivelling floodlight
- Replaceable safety glass
- Motion detector with a detection zone of 120° and 1 to 8 metres
- Continuous operation or adjustable from 10 seconds to 8 minutes
- Adjustable twilight and sensitivity switch
- LED beam angle: 120°
- Extra-large metal cable insertion for cables up to 3G1.5
- No power cord

Model	Luminous flux	Colour temperature	PU	EAN	Art. no.
10 watt	Approx. 850 lumen	4000 K (neutral white)	1	4011160464164	46416
20 watt	Approx. 1700 lumen	4000 K (neutral white)	1	4011160464072	46407
50 watt	Approx. 4250 lumen	4000 K (neutral white)	1	4011160464089	46408



LED battery-operated working lamp



Technical data

- Specially developed **ORIGINAL SAMSUNG SMD LED**: nominal lifetime of over 50000 hours
- Reinforced die-cast aluminium housing in a modern design with safety glass
- Foldable housing with rubber coating and multi-adjustable foot
- Splash-proof on/off switch
- 2 positions possible: Level 1 (50%): 850 lumen
Level 2 (100%): 1700 lumen
- Two strong magnets in the frame for attaching to metal surfaces
- Tool-free Li-ion battery replacement
- Battery with battery display and USB output (5 V/1 A)
- Charging time: approx. 4 hours
- Max. operating time: approx. 4 hours (level 1), approx. 2.5 hours (level 2)
- With charger and vehicle charging cable (12 V)
- Input voltage/frequency: 230 V/50 - 60 Hz
- **IP54**: protected against dust and splash-proof
- Tested in accordance with DIN EN 60598-1



Acculine Pro CHIP LED battery-operated working lamps with original SAMSUNG LED IP54

Model	Luminous flux	Colour temperature	Li-ion battery	PU	EAN	Art. no.
20 watt	Approx. 1700 lumen	4000 K (neutral white)	7.4 V 4400 mAh	1	4011160464928	46492
Replacement battery for art. no. 46492			7.4 V 4400 mAh	1	4011160464942	46494

LED battery-operated floodlight



Technical data

- Tested in accordance with DIN EN 60598-1

Acculine Octa LED battery-operated floodlight

IP65

NEW



- Extremely long-lasting LEDs with a nominal lifetime of over 40000 hours
- Robust die-cast aluminium housing
- Partly rubberised surface for optimal edge protection
- 360° swivelling and lockable holder
- Strong magnet for attaching to metal surfaces
- LED beam angle: 120°
- 3 positions possible: Level 1 (100%): 1400 lumen
Level 2 (50%): 700 lumen
Level 3 (25 %): 350 lumen
- Li-ion battery 3.7 V/5,200 mAh with battery status display
- Charging time: approx. 4 hours
- Max. operating time: approx. 8 hours (level 3), approx. 4 hours (level 2), approx. 2.8 hours (level 1)
- Connection: 5 V/2 A with USB charging cable type C
- **IP65:** dust-tight and jet-water-proof



Charge status display and on/off switch on the back.

Model	Luminous flux	Colour temperature	Li-ion battery	PU	EAN	Art. no.
15 watt	Approx. 1400 lumen	6000 K (neutral white)	3.7 V 5200 mAh	1	4011160463655	46365





Tripod without cross bar



- High processing quality
- Powder-coated
- Very good stability thanks to the three-legged frame
- Infinitely height-adjustable **from 1 to 1.8 m**
- With practical cable rewinder
- Max. 6 kg load capacity

Version	PU	EAN	Art. no.
Tripod without cross bar	1	4011160466502	46650

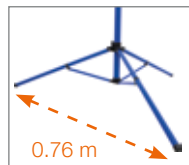

Tripod XL with cross bar

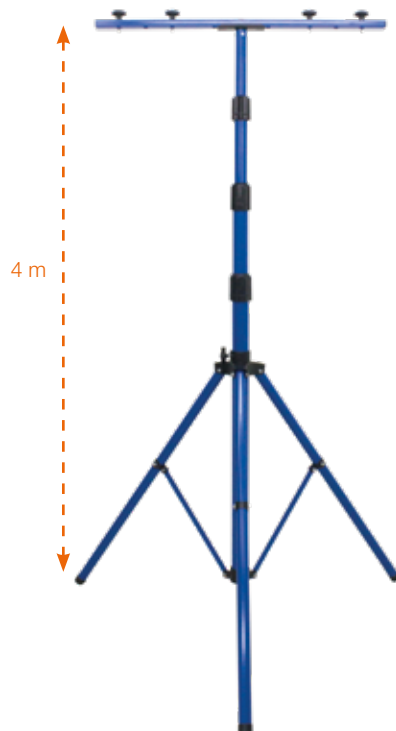

- High processing quality
- Shock-resistant powder coating
- Very good stability thanks to the three-legged frame
- Infinitely height-adjustable **from 1.4 to 4 m**
- Max. 30 kg load capacity

Version	PU	EAN	Art. no.
Tripod XL with cross bar	1	4011160467516	46751

Cross bar dimensions

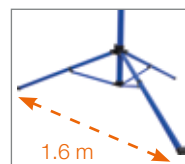
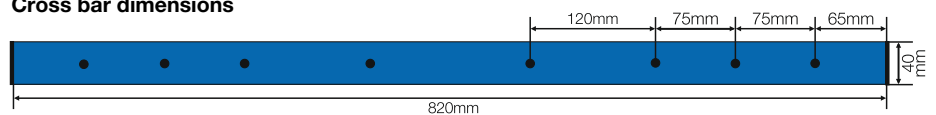



Professional tripod with universal cross bar



- High processing quality
- Galvanised
- Very good stability thanks to the three-legged frame
- Tripod with support and universal cross bar
- Infinitely height-adjustable **from 1 to 2.6 m**
- Max. 7 kg load capacity

Version	PU	EAN	Art. no.
Professional tripod with universal cross bar	1	4011160467509	46750

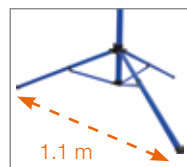

Universal cross bar dimensions

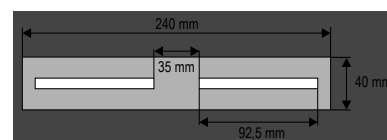

Support dimensions

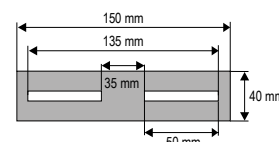

Professional tripod XXL with cross bar

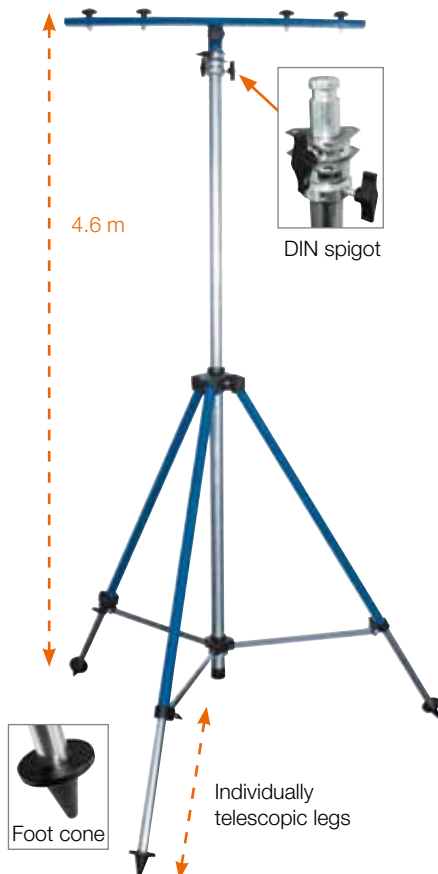

- High processing quality
- Powder-coated iron tube frame with 5 tube elements and adjusting screws
- Tripod with DIN spigot and 820-mm-long cross bar with DIN support to ensure quick assembly and quick securing of the working lamps onto the tripod
- Legs include foot cones for very good stability
- Includes 3 safety cords with snap hook and 3 ground spirals for stability
- Adjustable height **from 1.3 to 4.6 m**
- Max. 40 kg load capacity

Version	PU	EAN	Art. no.
Professional tripod XXL with cross bar	1	4011160467585	46758

Cross bar dimensions

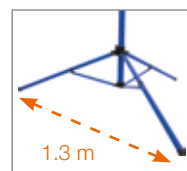
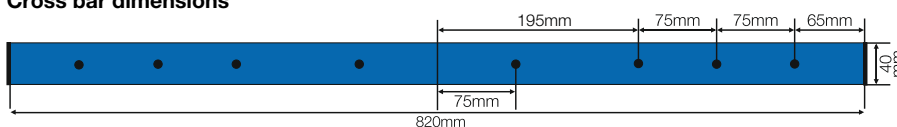

3 safety cords with snap hook and ground peg included in delivery

Optiline:

A professional offer with optimised solutions



LED floodlight with motion detector



LED floodlight



LED floodlight



LED working lamps with tripod

Models with foldable frame



Mobile LED working lamps

Optiline: A professional offer with optimised solutions



Technical data

- LEDs with a nominal lifetime of over 40000 hours
- Colour temperature: 4000 K (neutral white)
- LED beam angle: 100°
- Slimline die-cast aluminium housing with swivelling and lockable fastening material
- Power cord and glass cannot be replaced
- Input voltage/frequency: 220-240 V/50 Hz
- Tested in accordance with DIN EN 60598-1

Optiline LED floodlights



IP65

Model	Luminous flux	Version	PU	EAN	Art. no.
10 watt	Approx. 900 lumen		1	4011160463235	46323
20 watt	Approx. 1800 lumen	• With 1 m rubber power cable H05RN-F 3G1.0 without plug	1	4011160463242	46324
50 watt	Approx. 4500 lumen	• IP65: dust-tight and splash-proof	1	4011160463259	46325
100 watt	Approx. 9000 lumen		1	4011160463266	46326

Optiline LED floodlight with motion detector



IP44

Model	Luminous flux	Version	PU	EAN	Art. no.
10 watt	Approx. 900 lumen	• Motion detector with a detection zone of 100° and up to 8 metres	1	4011160463334	46333
20 watt	Approx. 1800 lumen	• With 1 m rubber power cable H05RN-F 3G1.0 without plug	1	4011160463341	46334
50 watt	Approx. 4500 lumen	• IP44: protected against foreign bodies and splash-proof	1	4011160463358	46335

Optiline mobile LED working lamps with tripod

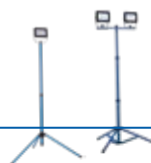

IP65

Model	Luminous flux	Version	PU	EAN	Art. no.
30 watt	Approx. 2700 lumen	• Powder-coated tripod, height-adjustable, collapsible • With 3 m rubber power cable H05RN-F 3G1.0 • With safety plug	1	4011160463501	46350
2x 30 watt	Approx. 2 x 2700 lumen	• Height-adjustable to: 1.6 m (art. no. 46350), up to 1.4 m (art. no. 46351) • IP65: dust-tight and jet-water-proof	1	4011160463518	46351

Optiline mobile LED working lamps



IP65

Model	Luminous flux	Version	PU	EAN	Art. no.
20 watt	Approx. 1800 lumen		1	4011160463402	46340
50 watt	Approx. 4500 lumen	• Foldable frame with insulated handle	1	4011160463419	46341
100 watt	Approx. 9000 lumen	• With 3 m rubber power cable H05RN-F 3G1.0 with shock-proof plug	1	4011160463426	46342
150 watt	Approx. 13500 lumen	• IP65: dust-tight and jet-water-proof	1	4011160463433	46343

Optiline mobile LED floodlight



IP54

Model	Luminous flux	Version	PU	EAN	Art. no.
24 watt	Approx. 1920 lumen	• Housing made from special plastic with foldable stand • Polycarbonate diffuser plate • 3 m heavy-duty rubber cable H07RN-F 3G1.5 with shock-proof plug	1	4011160463440	46344
45 watt	Approx. 3800 lumen	• IP54: protected against dust and splash-proof	1	4011160463457	46345

- One shock-proof socket outlet with flap lid
- USB output: 5 V/1.0 A
- With on and off switch
- Two shock-proof socket outlets with flap lids
- 3 switch levels: 50%, 100%, off

LED battery-operated floodlight with magnet attachment



Technical data

- Tested in accordance with DIN EN 60598-1
- **IP54:** protected against dust and splash-proof

NEW



Acculine Flex LED battery-operated floodlight

IP54

- Extremely long-lasting LEDs with a nominal lifetime of over 50000 hours
- Robust, extremely slimline die-cast aluminium housing with edge protection
- 180° swivelling and lockable holder
- Strong magnet for attaching to metal surfaces
- LED beam angle: 120°
- 2 positions possible: Level 1 (50%) and level 2 (100%)
- Li-ion battery with battery status display and USB output (5 V/1 A), e.g. for charging mobile phones
- Charging time: approx. 4 hours
- Max. operating time: approx. 4 hours (level 1), approx. 2 hours (level 2)
- Micro USB charging cable with charger 230 V/50-60 Hz
- Input voltage/frequency: 230 V/50 – 60 Hz

Model	Luminous flux	Colour temperature	Li-ion battery	PU	EAN	Art. no.
10 watt	Approx. 1,100 lumen	4000 K (neutral white)	3.7 V 4,400 mAh	1	4011160463600	46360
20 watt	Approx. 2,200 lumen	4000 K (neutral white)	3.7 V 8,800 mAh	1	4011160463617	46361

Solar floodlight with motion detector



Technical data

- Tested in accordance with DIN EN 60598-1
- **IP44:** protected against foreign bodies and splash-proof

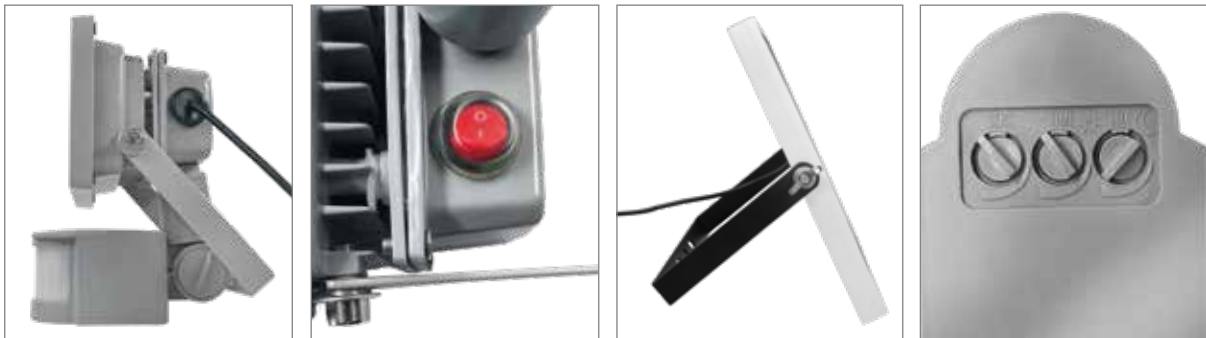
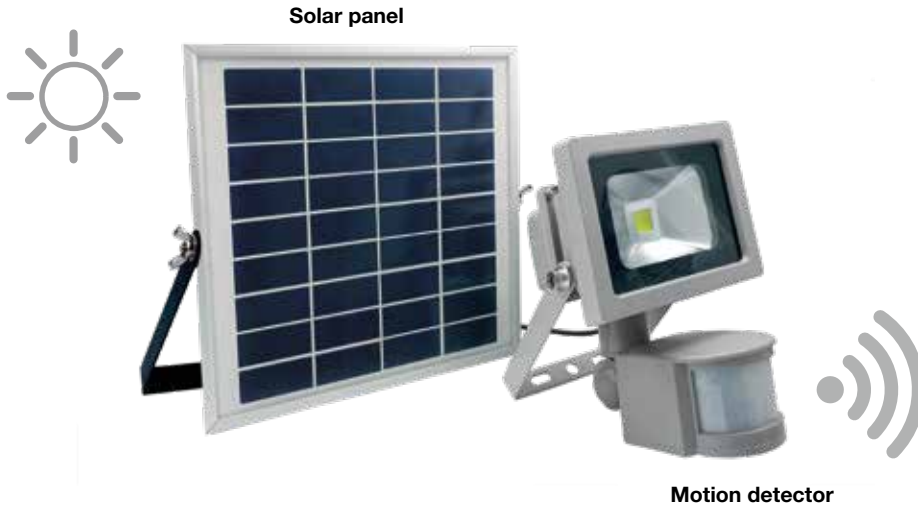

Solarline Chip LED floodlight with motion detector

IP44

- Specially developed SMD LED: nominal lifetime of over 25,000 hours
- Reinforced die-cast aluminium housing in a modern design
- Lockable, swivelling floodlight
- Motion detector: Sensor 180°
- Detection zone: up to 12 metres
- Adjustable from 10 seconds to 6 minutes
- Adjustable twilight and sensitivity switch
- Polycrystalline solar panel (3.5 W/14.5 V) with battery (7.4 V/1,800 mAh)
- Charging time: approx. 10 hours
- Operating time: approx. 4 hours
- LED beam angle: 120°
- 3 m connecting cable between light and solar panel

Model	Luminous flux	Colour temperature	PU	EAN	Art. no.
10 watt	Approx. 550 lumen	5,000 K (neutral white)	1	4011160469787	46978

LICHTFABRIK

LIGHTING FOR PROFESSIONALS

as[®]
Schwabe
TechnikProdukte

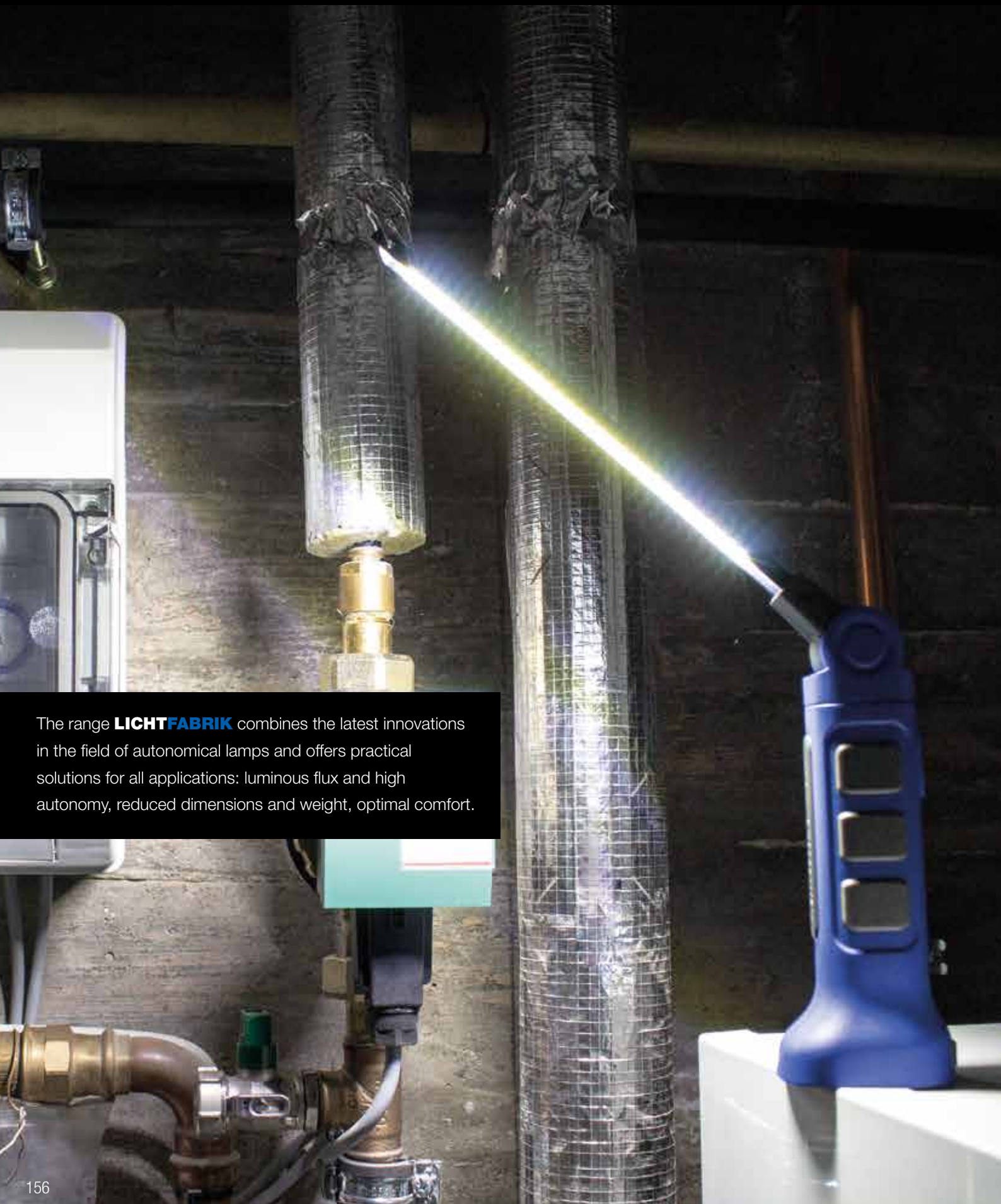

The range **LICHTFABRIK** combines the latest innovations in the field of autonomous lamps and offers practical solutions for all applications: luminous flux and high autonomy, reduced dimensions and weight, optimal comfort.



EVO 6 battery-operated LED inspection lamp

IP30



Magnetic foot

- Extremely slimline COB LED and 1 additional SMD LED in the lamp head (spotlight): nominal lifetime of over 50000 hours
- Extremely bright thanks to the special mirrored surface
- Infinitely adjustable 180° swivelling on 2 sides
- With suspension hook on the lamp head and built-in magnet foot
- Li-ion battery 3.7 V (2,600 mAh)
- Charging time: approx. 3 hours
- Operating time: Side light strand approx. 2.5 hours, spotlight approx. 10 hours
- Input voltage/frequency: 100-240 V/50-60 Hz
- Includes charger: charger with USB (5 V/1 A)
- **IP30:** protected against foreign bodies

Model	Luminous flux	Colour temperature	PU	EAN	Art. no.
4 + 1 watt	Approx. 300/70 lumen	6,000 K (daylight)	1	4011160428104	42810

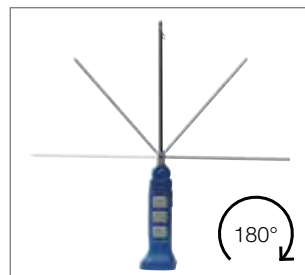

EVO 7 battery-operated LED handlamp

IP30



- Special 5 W COB LED and additional 3 W SMD LED in the lamp head: nominal lifetime of over 50000 hours
- With suspension hook on the top and strong magnet
- Li-ion battery 3.7 V/2600 mAh
- Charging time: approx. 4 hours
- Operating time: approx. 7 hours (level 1)
approx. 5.5 hours (level 2)
approx. 3 hours (level 3)
- Infinitely adjustable 120° swivelling on 2 sides and 180° rotating
- Includes USB charging cable (5 V/1 A)
- **IP30:** for indoor use

Model	Luminous flux	Colour temperature	PU	EAN	Art. no.
5 + 3 watt	Approx. 500/120 lumen	6500 K (daylight)	1	4011160428081	42808



Battery-operated LED standard lamp

IP20

Display
Model



- Special light strand COB LED and 3 additional LEDs in the lamp head
- Rubber-coated housing with foldable hook for suspension and 4 magnets on the back
- Li-ion battery 3.7 V/2000 mAh with charge status display
- Charging time: approx. 3 hours
- Operating time: up to 4 hours
- Includes USB charger (5 V/1 A)
- 3 positions possible: ON - Head LED only - OFF
- **IP20:** for indoor use

Model	Luminous flux	Colour temperature	PU	EAN	Art. no.
2 watt	Approx. 200/20 lumen	6000 K (daylight)	1	4011160428203	42820



EVO 8 battery-operated ultra-compact LED inspection lamp

IP30



Foldable handlamp

- Rubber-coated housing
- Very flexible lamp due to 270° swivelling design
- With specially developed COB LED: nominal lifetime of over 50000 hours
- Additional spotlight (100 lm) for spot lighting
- With foldable hook and magnetic foot
- Li-ion battery 3.8 V/2800 mAh with charge status display
- Charging time: approx. 4.5 hours
- Operating time: up to 5 hours
- Includes USB charger 5 V/1 A
- 5 positions possible: ON - level 1/level 2/spotlight - OFF
- **IP30:** protected against foreign bodies

Model	Luminous flux	Colour temperature	PU	EAN	Art. no.
3 + 1 watt	Approx. 250/500 lumen	6000 K (daylight)	1	4011160428241	42824

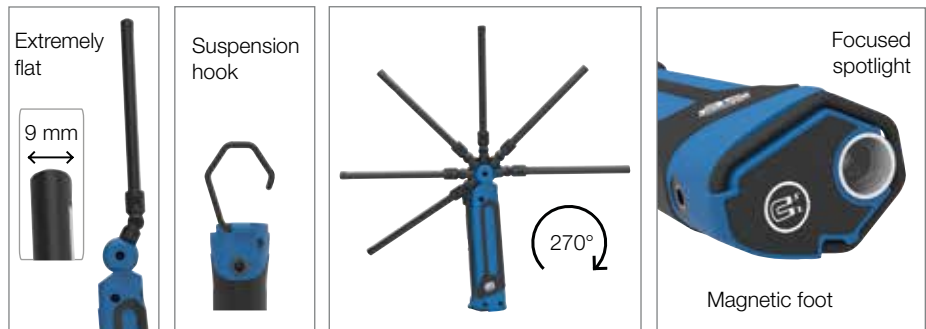

XT1 LED torch

IP30



- Powerful SMD LED in a robust die-cast aluminium housing: nominal lifetime of over 50000 hours
- Zoom from 0 to 5 metres
- 2 illumination levels and emergency flashing function
- Operating time at full output: approx. 6 hours
- Operating time at half output: approx. 10 hours
- Operating time using emergency flashing function: approx. 12 hours
- Includes 3x AAA batteries
- Dimensions: Ø 33 mm, length approx. 110 mm
- **IP30:** protected against foreign bodies

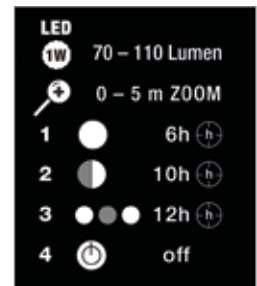

Model	Luminous flux	Colour temperature	PU	EAN	Art. no.
1 watt	Approx. 70-100 lumen	6400 K (daylight)	1	4011160428043	42804

Handlamps

EVO 1 battery-operated handlamp

IP30

With extendable suspension hook



- Special light string COB LED and 4 additional LEDs in the torch head: nominal lifetime of over 50000 hours
- LED with powerful luminosity (100 to 120 lux at 0.6 m)
- Li-ion battery 3.7 V (1400 mAh): twice the lifespan compared to NiMH batteries, no memory effect
- Charging time: approx. 2 hours
- Operating time: approx. 2.5 hours
- Rubber-coated housing with extendable suspension hook
- 180° swivelling magnet foot
- 100 - 230 V / 50 - 60 Hz mains charger and 12/24 V vehicle charger
- **IP30:** for indoor use

Model	Luminous flux	Colour temperature	PU	EAN	Art. no.
3 watt	Approx. 65/20 lumen	6400 K (daylight)	1	4011160428036	42803



With magnetic foot

EVO 4 battery-operated handlamp

IP65



- Special light strand COB LED
- With two-level switch: Level 1 = 100%, level 2 = 50% luminous flux
- 180° swivelling foot with integrated magnet
- Additional belt clip on the back
- Foldable, 360° rotating hook
- Li-ion battery 3.7 V (1000 mAh)
- Charging time: approx. 2 hours
- Operating time: approx. 5 hours
- 100 - 240 V/50-60 Hz charger
- **IP65:** dust-tight and jet-water-proof

Model	Luminous flux	Colour temperature	PU	EAN	Art. no.
1.5 watt	Approx. 125 lumen	6000 K (daylight)	1	4011160428227	42822



Headlamps

HD 150 battery-operated headlamp

IP30



- With specially developed COB LED: nominal lifetime of over 50000 hours
- On/off switch
- Luminosity adjustable in two steps
- With size-adjustable headband and forehead pad
- Li-ion battery 3.7 V/800 mAh with charge status display
- Charging time: approx. 3 hours
- Operating time: up to 4 hours
- Includes USB charger 5 V/1 A
- **IP30:** for indoor use

Model	Luminous flux	Colour temperature	PU	EAN	Art. no.
2 watt	Approx. 75 / 150 lumen	6000 K (daylight)	4	4011160428234	42823

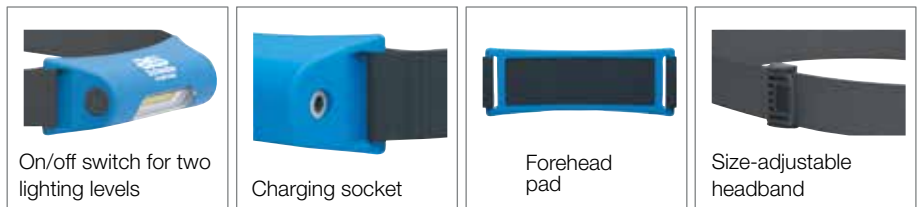

HD 200 battery-operated headlamp with sensor

IP54



- With specially developed COB LED: nominal lifetime of over 50000 hours
- Operated using the on/off switch or contactless motion detector
- Switch level 1: 200 lm, operating time approx. 1.8 h
- Switch level 2: 100 lm, operating time approx. 4 h
- Sensor actuation: 150 lm, operating time approx. 1.8 h
- With size-adjustable headband
- Li-ion battery 3.7 V/600 mAh with charge control
- Charging time: approx. 2.5 hours
- Operating time: up to 4 hours
- Beam angle: 120°
- Ultra-light: Weight incl. headband 42g
- Impact resistance: IK07
- Includes USB charger 5 V/1 A

Model	Luminous flux	Colour temperature	PU	EAN	Art. no.
2 watt	Approx. 100 / 200 lumen	6500 K (daylight)	1	4011160428258	42825

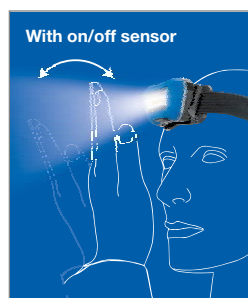

Handlamps



Technical data

- 230 V, 16 A
- Tested in accordance with DIN EN 60598-1
- **IP44/IP54:** for outdoor use

Professional battery-operated LED handlamp

IP54



- 8 powerful SMD LEDs and 1 additional LED in the lamp head
- Li-ion battery 3.7 V (2000 mAh), charging time: approx. 3 hours
- Operating time: SMD LED up to 3.5 hours, torch up to 7.5 hours
- Bulb lifespan: over 50000 hours
- Ergonomically shaped, rubberised housing, largely oil and acid-resistant
- Foldable, 360° rotating suspension device
- Integrated magnet on the back, with on/off switch
- Stable table charger also suitable for wall mounting
- 230 V/50 Hz, 12 V/DC

Model	Luminous flux	Colour temperature	PU	EAN	Art. no.
3 + 1 watt	Approx. 250/95 lumen	6400 K (daylight)	1/10	4011160424175	42417

LED handlamp

IP54



- 60 LEDs with very high luminosity
- Illuminance at a distance of 20 cm: approx. 800 lux
- Illuminance at a distance of 40 cm: approx. 750 lux
- Bulb lifespan: over 50000 hours
- Integrated rotating suspension hook made from shatterproof special plastic
- Switch in the handle
- Operating voltage 230 Volt, 50 Hz, power consumption 3.5 W
- 5 m rubber power cable H05RN-F 2x1.0

Model	Luminous flux	Colour temperature	PU	EAN	Art. no.
3.5 watt	Approx. 166 lumen	6400 K (daylight)	1/10	4011160424113	42411

Professional handlamp with electronic ballast

IP54



- Rotating hook made from shatterproof special plastic
- Switch in the handle
- 11 W energy-saving light, exchangeable bulb
- Bulb lifespan: over 10000 hours
- Can be used at temperatures from -20°C
- 5 m rubber power cable H05RN-F 2x1.0

Model	Luminous flux	Colour temperature	PU	EAN	Art. no.
11 watt	Approx. 780 lumen	6400 K (daylight)	1/10	4011160423116	42311
Replacement bulb 11 watt (G23/2 pin)	Approx. 780 lumen	6400 K (daylight)	1	4011160422119	42211

Energy-saving magnetic working lamp MAL 20

IP44



- Rotating reflector: Light is only emitted towards the front, and can be used for spotlight illumination
- 20 W energy-saving lamp E27 for work-friendly light: nominal lifetime of over 6000 hours
- Ergonomic handle with foldable and rotating suspension hook
- 360° rotating fastening bracket and magnet for attachment onto metal surfaces
- On/off switch with rubber protective cap
- 5 m rubber power cable H05RN-F 2x1.0

Model	Luminous flux	Colour temperature	PU	EAN	Art. no.
20 watt	Approx. 1200 lumen	6400 K (daylight)	1/10	4011160424229	42422
Replacement bulb 20 watt (E27/3U)	Approx. 1200 lumen	6400 K (daylight)	1	4011160468414	46841

Handlamps



Technical data

- 230 V/16 A
- Tested in accordance with DIN EN 60598-1
- **IP20:** for indoor use

Battery-operated LED lamp

IP20



Car charger optional



- 28 LEDs with very high luminosity: nominal lifetime of over 10000 hours
- 360° rotating suspension device
- NiMH battery with 3.6 V/DC output: lasts longer than conventional NiCd batteries, low self-discharge
- Operating time: up to 5 hours
- With 230 V, 50 - 60 Hz charger
- Detachable magnet with rubber protection, rubberised housing
- On/off switch

Model	Luminous flux	Colour temperature	PU	EAN	Art. no.
2.5 watt	Approx. 52 lumen	6400 K (daylight)	1/12	4011160424120	42412
Vehicle charging cable with 2 m power cord			1	4011160424137	42413

Battery-operated LED tube lamp HH 60

IP20



- 60 bright-white LEDs, operating time approx. 2.5 h
- Bulb lifespan: over 30000 hours
- 3 integrated NiMH batteries 3.7 V 1800 mAh, can be charged via mains adapter or 12 V vehicle charging cable
- Includes mains charging adapter and vehicle charging cable
- Low power consumption and minimal heat build-up
- Convenient shape with suspension hook
- On/off switch with rubber protective cap
- Dimensions: 44 cm x Ø 5.5 cm
- 230 V/50 Hz, 12 V/DC

Model	Luminous flux	Colour temperature	PU	EAN	Art. no.
3 watt	Approx. 200 lumen	6400 K (daylight)	1/10	4011160424359	42435

Fluorescent handlamp

IP20



- Electronic ballast
- Rotating hook
- With Euro plug
- Non-exchangeable bulb
- Bulb lifespan: over 6000 hours
- 5 m rubber power cable H05RN-F 2x0.75

Model	Luminous flux	Colour temperature	PU	EAN	Art. no.
8 watt	Approx. 300 lumen	6400 K (daylight)	1/10	4011160423031	42303

Handlamp

IP20



- With rubber handle, galvanised protection cage and protective glass
- With shock-absorbing bead ring
- Bulb not included
- Suitable for bulbs with a total length of up to 130 mm and a maximum width of 50 mm
- Base E27, max. 100 W
- 5 m rubber power cable H05RN-F 2x1.0

Model	PU	EAN	Art. no.
100 watt	1/10	4011160472503	47250

Oval and round lights



Technical data

- Tested in accordance with EN 60598-1

Oval lamp

IP44



- Housing with fastening straps
- Structural glass with protection cage
- Base E27
- Bulb not included
- Input voltage/frequency: 230 V/50-60 Hz
- **IP44:** for outdoor use

Model	Colour	PU	EAN	Art. no.
Up to 60 watt	Black	10	4011160561115	56111
Up to 60 watt	White	10	4011160561122	56112

Round lamp

IP44



- Crystal glass with protection cage
- Stable thermoplastic housing
- Base E27
- Bulb not included
- Input voltage/frequency: 230 V/50-60 Hz
- **IP44:** for outdoor use

Model	Colour	PU	EAN	Art. no.
Up to 100 watt	Black	6	4011160660016	66001
Up to 100 watt	White	6	4011160660023	66002

Infra-red motion detector

IP44



- Detection zone up to 12 m
- Switching capacity up to max. 800 W
- Duty cycle adjustable from 10 seconds to 15 minutes
- Dimmer switch adjustable from 3 to 2000 lux
- Operating temperature: -20°C to +40°C
- With vertical and corner bracket:
For assembly on straight walls and 90° corners
- Input voltage/frequency: 230 V/50-60 Hz
- **IP44:** for outdoor use

Model	Colour	PU	EAN	Art. no.
180° detection angle	White	1	4011160438035	43803
180° detection angle	Black	1	4011160438042	43804

LED wall lamps



Technical data

- Tested in accordance with EN 60598-1



Wall lamps in a modern design:
Extremely flat, robust and weather-resistant!



Art. no. 56730



Art. no. 56731



Art. no. 56720



Art. no. 56721



Art. no. 56770



Art. no. 56771

LED wall lamps for fixed installation

with original **SAMSUNG LED** **IP65**

- With polycarbonate diffuser
- Specially developed **ORIGINAL SAMSUNG SMD LED**: nominal lifetime of over 30000 hours
- No cable, with 2 cable insertions for cables up to 3G1.5
- Colour temperature: 4000 K (neutral white)
- Impact resistance: IK10
- Input voltage/frequency: 230 V/50 - 60 Hz
- **IP65**: dust-tight and jet-water-proof

Model	Luminous flux	Version	Width x height x depth	Colour	PU	EAN	Art. no.
7 watt	Approx. 680 lumen	Oval	175 x 90 x 46 mm	White	1	4011160567704	56770
7 watt	Approx. 680 lumen	Oval	175 x 90 x 46 mm	Anthracite	1	4011160567711	56771
20 watt	Approx. 1680 lumen	Oval	250 x 125 x 52 mm	White	1	4011160567209	56720
20 watt	Approx. 1680 lumen	Oval	250 x 125 x 52 mm	Anthracite	1	4011160567216	56721
20 watt	Approx. 1660 lumen	Round	220 x 220 x 52 mm	White	1	4011160567308	56730
20 watt	Approx. 1660 lumen	Round	220 x 220 x 52 mm	Anthracite	1	4011160567315	56731

Halogen floodlights



Technical data

- Base R7s, halogen bulb, 3-way spiralled
- Colour temperature: 2800 K (warm white)
- Input voltage/frequency: 230 V/50 - 60 Hz
- **IP54:** dust-tight and splash-proof
- **IP65:** dust-tight and jet-water-proof
- Tested in accordance with DIN EN 60598-1



Halogen floodlights

IP54/IP65



- Housing made from die-cast aluminium with cooling fins for better heat dissipation
- Halogen lamps with a lifespan of over 2000 hours
- Lamp socket R7s with insulated, heat-resistant cables
- Bulb included



Model	Luminous flux	Version	Power cord	PU	EAN	Art. no.
400 watt	Approx. 8600 lumen	Black	With 2 m rubber power cable	1	4011160440595	44059
1000 watt	Approx. 18000 lumen	Black	H07RN-F 3G1.0	1	4011160441097	44109
1500 watt	Approx. 26000 lumen	Black	With shock-proof plug, IP54	1	4011160441592	44159
2000 watt	Approx. 35000 lumen	Black	With 4.5 m rubber power cable H07RN-F 3G1.5 With shock-proof plug, IP65	1	4011160472091	47209
400 watt	Approx. 8600 lumen	White	No power cord, IP54	1	4011160440618	44061
400 watt	Approx. 8600 lumen	Black		1	4011160440601	44060
1000 watt	Approx. 18000 lumen	Black		1	4011160441004	44100
1500 watt	Approx. 26000 lumen	Black		1	4011160441509	44150

Mobile light for craftsmen

IP54



- Housing made from die-cast aluminium with adjustment bracket and protective grille
- Lamp socket R7s with insulated, heat-resistant cables
- With 2 m rubber power cable H05RN-F 3G1.0 with shock-proof plug
- Bulb included

Model	Luminous flux	Version	PU	EAN	Art. no.
400 watt	Approx. 8600 lumen	Black	1	4011160465604	46560
1000 watt	Approx. 18000 lumen	Black	1	4011160465703	46570

Halogen floodlight on tripod

IP54



Art. no.
46780

Art. no.
46795

- Tripod made from very robust, plastic-coated steel tubing, space-saving collapsible design
- **Height-adjustable from 0.7 to 2 m**
- With 2.5 m rubber power cable H05RN-F 3G1.0 with shock-proof plug
- Welded-on hook for safe cable rewinding
- With handy tube clamping nuts for adjusting
- Lamp socket R7s with insulated, heat-resistant cables
- Bulb included: Halogen lamps with a nominal lifetime of over 2,000 hours

Model	Luminous flux	PU	EAN	Art. no.
1 × 400 watt	Approx. 8600 lumen	1	4011160467806	46780
2 × 400 watt	Approx. 17200 lumen	1	4011160467950	46795

Halogen lamp



Model	Luminous flux	Length	PU	EAN	Art. no.
120 watt	2300 lumen	78 mm	1	4011160460104	46010
230 watt	4800 lumen	118 mm	1	4011160460111	46011
400 watt	8600 lumen	118 mm	1	4011160460128	46012
1000 watt	18000 lumen	189 mm	1	4011160461019	46101
1500 watt	26000 lumen	254 mm	1	4011160461514	46151
2000 watt	35000 lumen	333 mm	1	4011160462016	46201

Energy-saving working lamps



Technical data

- Tested in accordance with DIN EN 60598-1

Spectra all-purpose working lamp

IP44



- Cost-effective energy-saving lamp with even, shadow-free illumination
- Energy-saving fluorescent tubes with a lifespan of over 10000 hours
- Easy tube replacement
- Less susceptible to faults than the halogen lamps due to lack of spiralling
- Lockable adjustment position, option of tripod installation
- 5 m rubber power cable H07RN-F 3G1.5 with shock-proof plug
- 2 shock-proof socket outlets with safety flap lids
- Bulb included
- Input voltage/frequency: 230 V/50 - 60 Hz
- Base 2G11
- **IP44:** protected against foreign bodies and splash-proof

Model	Luminous flux	Colour temperature	PU	EAN	Art. no.
72 watt	Approx. 5900 lumen	6400 K (daylight)	1	4011160468759	46875
Replacement bulb 36 watt 2G11	Approx. 5900 lumen	6400 K (daylight)	1	4011160468919	46891



PowerTech 190 energy-saving working lamp

IP44



- Very robust solid rubber seal and impact-resistant hood
- Built-in shock-proof socket outlets with self-locking safety flap lid
- Foldable hook for suspension and carrying
- Low-glare illumination
- 1.8 m rubber power cable H07RN-F 3G1.5 with shock-proof plug
- Energy-saving bulb included
- Bulb lifespan: over 8000 hours
- Input voltage/frequency: 230 V/50 - 60 Hz
- Base GR 10q
- **IP44:** protected against foreign bodies and splash-proof

Model	Luminous flux	Colour temperature	PU	EAN	Art. no.
38 watt	Approx. 2700 lumen	6400 K (daylight)	1	4011160468384	46838
Replacement bulb 38 watt GR10q	Approx. 2700 lumen	6400 K (daylight)	1	4011160468247	46824





Energyline XL

For the very best lighting conditions on the construction site

Energyline XL LED floodlight for large areas



Technical data

- Premium large-area floodlight for robust applications on construction sites
- With robust adjustable bracket for installation on cranes etc.
- Extremely impact-resistant die-cast aluminium housing: IK08
- Polycarbonate diffusing disc with lenses for better light distribution
- Extremely long-lasting high-performance- LEDs with a nominal lifetime of over 50000 hours
- Beam angle: 90°
- Input voltage/frequency: 230 V/50-60 Hz
- **IP66:** dust-tight and water-tight for outdoor use



Storage hall illumination with an Energyline large-area floodlight. Left image: Floodlight switched off. Right image: Floodlight switched on.



Car park illumination from a substantial height.



Art. no. 46273



Art. no. 46272



Art. no. 46271



Model	Luminous flux	Colour temperature	Version	PU	EAN	Art. no.
180 watt	Approx. 25200 lumen	4000 K (neutral white)	4.5 m rubber power cable H07RN-F 3G1.5 with shock-proof plug	1	4011160462719	46271
540 watt	Approx. 75600 lumen	4000 K (neutral white)	10 m rubber power cable H07RN-F 3G1.5 with shock-proof plug	1	4011160462726	46272
1080 watt	Approx. 151200 lumen	4000 K (neutral white)	25 m rubber power cable H07RN-F 3G1.5 with shock-proof plug	1	4011160462733	46273

HQI floodlight for large areas

Light for any construction site



HQI floodlight for large areas



Technical data

- Die-cast aluminium housing
- Ultra-pure aluminium reflector, polished and anodised
- Safety glass with high temperature resistance and silicone rubber seal
- Steel installation bracket with graduation for vertical adjustment
- Lamp socket E40, bulb included
- Tested in accordance with DIN EN 60598-1
- **IP65:** dust-tight and jet-water-proof



Model Jet 400 W

- Die-cast aluminium housing
- Bulb lifespan: over 20000 hours
- With 4.5 m rubber power cable H07RN-F 3G1.5 with shock-proof plug
- Input voltage/frequency: 230 V/50-60 Hz

Model	Luminous flux	Colour temperature	PU	EAN	Art. no.
400 watt	Approx. 35000 lumen	4000 K (neutral white)	1	4011160462689	46268
Replacement bulb 400 W HPI-T E40	Approx. 35000 lumen	4000 K (neutral white)	1	4011160462528	46252
Protective grille (optional)			1	4011160462696	46269



Model Jet 1,000 W

- Die-cast aluminium housing with thermally separated box for ballast unit
- Bulb lifespan: over 10000 hours
- With 4.5 m rubber power cable H07RN-F 3G1.5 with shock-proof plug
- Input voltage/frequency: 230 V/50-60 Hz

Model	Luminous flux	Colour temperature	PU	EAN	Art. no.
1000 watt	Approx. 85000 lumen	4300 K (neutral white)	1	4011160462603	46260
Replacement bulb 1000 W HPI-T E40	Approx. 85000 lumen	4300 K (neutral white)	1	4011160462610	46261



Model Jet 2,000 W

- Die-cast aluminium housing with external ballast unit
- Bulb lifespan: over 5500 hours
- With 10 m intermediate cable H07RN-F 3G2.5
- With 4.5 m rubber power cable H07RN-F 5G2.5 with CEE plug 400 V, 16 A
- Input voltage/frequency: 400 V/50 - 60 Hz

Model	Luminous flux	Colour temperature	PU	EAN	Art. no.
2000 watt	Approx. 200000 lumen	4550 K (neutral white)	1	4011160462658	46265
Replacement bulb 2000 W HQI-T E40	Approx. 200000 lumen	4550 K (neutral white)	1	4011160462665	46266

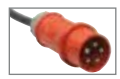
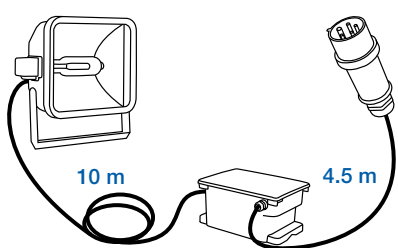



10

Infra-red thermometers	174
Moisture measuring devices	175
Illuminance measuring devices	175
Noise level measuring devices	175

Measuring devices

Standard infra-red thermometer

IP20



- Infra-red thermometer for quick and easy temperature measurements
- Perfect for objects that a thermometer cannot be placed on.
- Temperature range: -50°C to +380°C
- Response time: 500 ms
- Large illuminated display with a decimal place
- Display illumination and laser can be switched on and off
- Power supply: 2x AAA-batteries (included)
- **IP20:** for indoor use

Version	Colour	PU	EAN	Art. no.
Standard infra-red thermometer	Blue	1	4011160241017	24101

Professional infra-red thermometer

IP20



- Infra-red thermometer for quick and easy temperature measurements
- Perfect for objects that a thermometer cannot be placed on.
- Temperature range: -50°C to +900°C
- Response time: 500 ms
- With data storage: saves up to 30 values
- Large illuminated display with a decimal place
- Display illumination and laser can be switched on and off
- Includes practical transport case
- Power supply: 9 V battery (included)
- **IP20:** for indoor use

Version	Colour	PU	EAN	Art. no.
Professional infra-red thermometer	Blue	1	4011160241024	24102



Moisture meter

IP20



- For determining the amount of moisture in wood and construction materials, e.g. concrete, screed etc.
- Large illuminated 1-line display with a decimal place
- 4 electrodes (L: 11 mm) with protective cap
- Measurement range: Wood moisture 6% to 42%
Construction moisture 0.2% to 2%
- Warning of low battery status
- In a practical carry case
- Power supply: 9 V battery (included)
- **IP20:** for indoor use

Version	Colour	PU	EAN	Art. no.
Moisture meter	Blue	1	4011160241031	24103

Lux meter

IP20



- Digital light meter for professional illuminance measurement
- Measurement range: 0 to 200000 lux
- Photometric sensor made from high-quality silicon diode
- Battery lifespan: > 60 hours, warning of low battery status
- Operating temperature: 0°C to +40°C
- Display of maximum, minimum and deviations
- Large illuminated 1-line display with a decimal place
- Power supply: 9 V battery (included)
- **IP20:** for indoor use

Version	Colour	PU	EAN	Art. no.
Lux meter	Blue	1	4011160241048	24104

Decibel meter

IP20



- Digital noise level device
- Measurement range: 30 dBA to 130 dBA
- Large illuminated 1-line display with a decimal place
- Frequency range: 31.5 Hz to 8.5 KHz
- Microphone: 1/2 inch electret condenser microphone
- Warning of low battery status
- Power supply: 9 V battery (included)
- **IP20:** for indoor use

Version	Colour	PU	EAN	Art. no.
Decibel meter	Blue	1	4011160241055	24105

Hygrometer

IP20



- Digital meter for measuring the temperature, relative humidity and dew point
- Adjustable alarm function for when the set minimum and maximum values are exceeded or not met
- Measurement ranges: Temperature -10°C to +50°C
Humidity 20% to 95%
Dew point -29°C to +59°C
- Operating temperature: -10°C to +60°C
- Adjustable foot included
- Also suitable for wall mounting
- Power supply: 2x AAA-batteries (included)
- **IP20:** for indoor use

Version	Colour	PU	EAN	Art. no.
Hygrometer	Silver	1	4011160241062	24106



11

Automatic rewinding reels **178-179**

Air hoses **180**

Air hose reels **180**

Water level tools **181**

Compressed air

Air hose reels

With automatic rewinding function

Both models can be attached to the wall or ceiling.



Automatic air hose reel



- Compressed air hose rewinding mechanism with robust blue plastic housing
- Includes swivelling wall mount and fastening material
- 10 m unrollable yellow PCB knitted PVC-textile hose with hose stopper
- With automatic rewinding function
- Hose guide mechanism allows for neat hose winding
- 1 m connecting hose
- Max. pressure 12 bar
- Connection NW 7.2 plug-in nipple and quick connector
- Connecting pieces with steel anti-kink springs
- With quick-close connector
- Hose: Inner diameter x wall thickness: 10 x 3 mm

Version	Colour	PU	EAN	Art. no.
10 m PVC compressed air hose 10 × 3 mm with hose stopper	Blue	1	4011160126123	12612

Automatic air hose reel for professionals



- Compressed air hose rewinding mechanism with robust grey plastic housing
- Includes swivelling wall mount and fastening material
- 15 m unrollable blue polyurethane hose with hose stopper
- With automatic rewinding function
- Hose guide mechanism allows for neat hose winding
- 1 m polyurethane connecting hose
- Max. pressure 12 bar
- With quick-close connector and NW 7.2 plug-in nipple
- Connecting pieces with steel anti-kink springs
- Hose: Inner diameter x wall thickness: 8 x 2 mm

Version	Colour	PU	EAN	Art. no.
15 m PU compressed air hose 8 × 2 mm with hose stopper	Grey	1	4011160126130	12613



© spukkato

Air hoses



Air hose with fabric braiding series 2000



- PVC hose, transparent blue, with polyester fabric braiding, largely oil and petrol-resistant
- Temperature range: approx. -20°C to +65°C
- The polyester fabric braiding makes this hose particularly resistant to high pressures
- Hose: Inner diameter × wall thickness: 6 × 3 mm and 9 × 3 mm
- Max. pressure 15 bar

Version	Colour	PU	EAN	Art. no.
50 m PVC compressed air hose 6 × 3 mm	Blue	1/50	4011160127007	12700
50 m PVC compressed air hose 9 × 3 mm	Blue	1/50	4011160127014	12701

Air hose sets with polyester fabric braiding series 2050



- PVC compressed air hose, transparent blue, with polyester fabric braiding, complete with quick-close connector and socket, reinforced ready for use
- Connection NW 7.2 / 15 bar
- Hose: Inner diameter × wall thickness: 6 × 3 mm and 9 × 3 mm

Version	Colour	PU	EAN	Art. no.
5 m PVC compressed air hose 6 × 3 mm	Blue	1/300	4011160127021	12702
10 m PVC compressed air hose 6 × 3 mm	Blue	1/250	4011160127038	12703
20 m PVC compressed air hose 6 × 3 mm	Blue	1/200	4011160127045	12704
5 m PVC compressed air hose 9 × 3 mm	Blue	1/250	4011160127052	12705
10 m PVC compressed air hose 9 × 3 mm	Blue	1/200	4011160127069	12706
15 m PVC compressed air hose 9 × 3 mm	Blue	1/200	4011160127076	12707
20 m PVC compressed air hose 9 × 3 mm	Blue	1/200	4011160127083	12708

Air hose reels



- Special thermoplastic reel body
- Galvanised bow-handle frame
- Blue compressed air hose with DIN fitting
- Max. pressure 15 bar
- Connection NW 7.2
- Hose: Inner diameter x wall thickness 9 x 3 mm

Version	Colour	PU	EAN	Art. no.
20 m compressed air hose 9 × 3 mm	Blue	1/50	4011160126222	12622



Using a water level tool

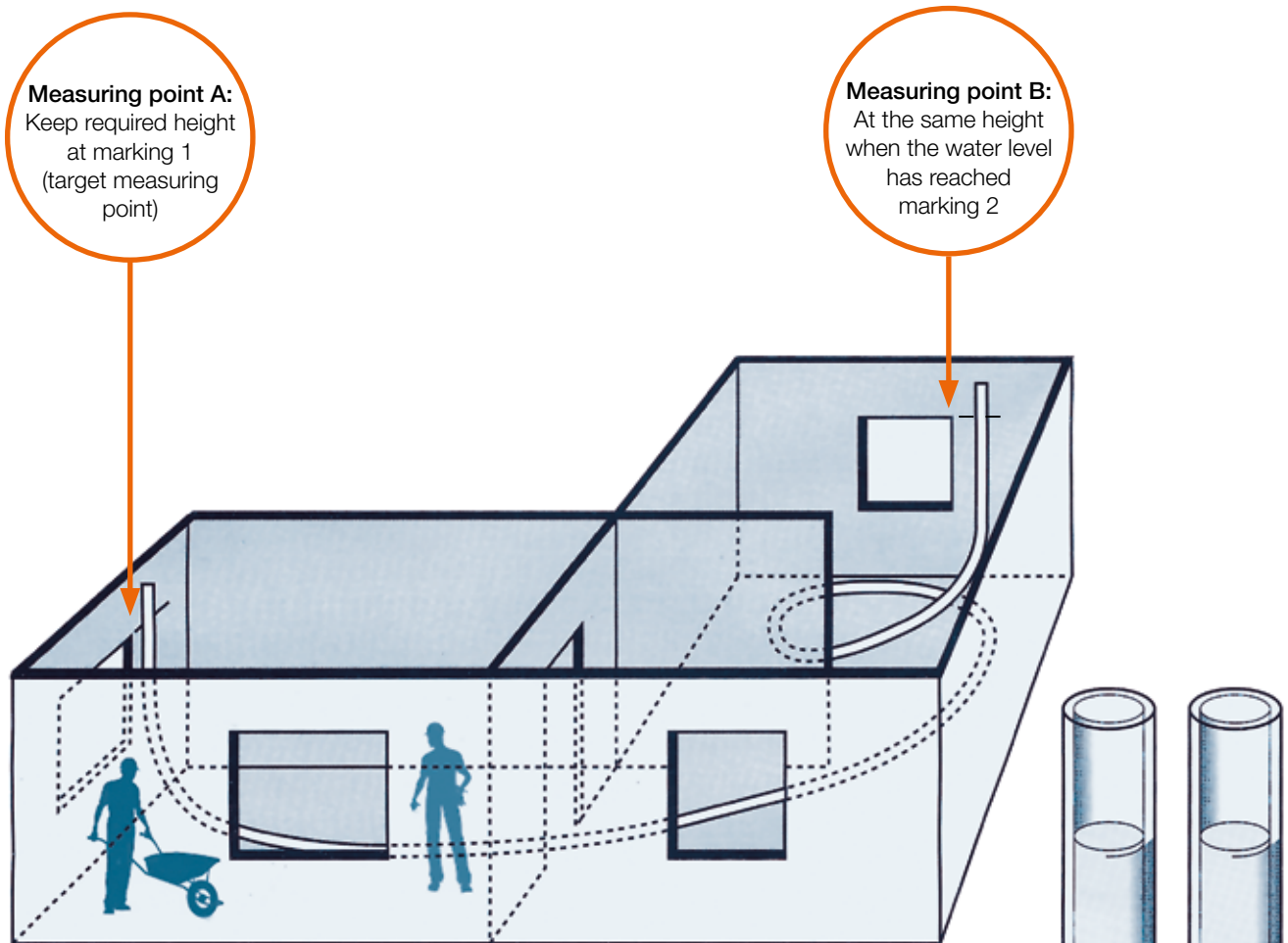

Water level tool series 2550



- Consisting of: PVC hose, crystal clear, one funnel and two stoppers
- Hose: Inner diameter x wall thickness: 8 x 1.5 mm

Version	PU	EAN	Art. no.
10 m PVC hose 8 x 1.5 mm	1/300	4011160127144	12714
15 m PVC hose 8 x 1.5 mm	1/250	4011160127106	12710
20 m PVC hose 8 x 1.5 mm	1/200	4011160127113	12711
25 m PVC hose 8 x 1.5 mm	1/200	4011160127120	12712
30 m PVC hose 8 x 1.5 mm	1/150	4011160127137	12713



Außenbereich
Outdoor
www.es-geraete.de

es
25m
H07RN-F 3G2.5
CE
IP44
H07RN-F 3G2.5
100% Kupfer
100% PVC
100% Zinn
100% Zinn

Made in Germany

12



Cable reels	184-187
Extensions	188-189
Adapter cords	190-193
Camping accessories	194
Energy meters	195
Power combination units	196-197
Multi socket outlets	198-199
STECKY power combination units	200-201
Plugs and connectors	202
Power supply inlets	203
Flanged sockets	204
Fuses	205
Caravan adapters	206-209

Camping/caravan

Camping

The right electrical equipment with as - Schwabe



If you want to spend your camping holiday without nasty surprises, check your equipment for completeness and functionality before departure. The electrical equipment is one of the most important and must meet the campsites standards. This catalogue shows the authorized products (✓).

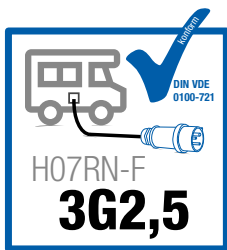

Standards

Electrical standards for power supply on Camping sites, Campervans, motorhomes or mobile homes have to be respected. According to DIN standard VDE 0100-72, heavy-duty rubber cable H07RN-F 3G2.5 **type H07RN-F** (or a higher quality) with a minimal **cross section of 2.5 mm²** is compulsory. **Maximum length** allowed of an extension cord is 25 m **plus**, if necessary, an **adapter cord of 1.5 m**.

These requirements are an integral part of any **site regulations**. If you fail to do so, the campsite owner may ask you to **rent** or **buy a cable** on site. If you refuse, **access to electricity can be denied**. Any illegal connection may lead to **prosecution**.

Compliance with regulations is essential for your insurance. In fact, the use of **non-compliant products** will lead to the **cancellation of your contract** in the event of an incident. For example an undersized cable section can cause a fire for which you are fully responsible with the resulting costs at your expense.

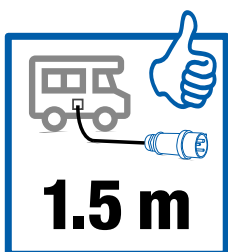

Our recommendation

Considering the **safety aspects** related to electric current, it is recommended to use devices fitted with **power cords longer than 1.5 m**. This length of cable makes it possible to connect power cords to a socket an inlet positioned high, **letting the mobile connection rest on the ground, under the vehicle for example**.

The advantage is that any traction effort both on the socket and on the mobile connection is avoided. In addition, the power supply inlet is not loaded. Indeed, tensile stress should always be avoided on these two connections, since in the worst case, **loose contact connections** can cause **socket fires**. **Short circuits** can also **damage** the connected devices. If you want to be on the safe side, consider our recommendation and only use products with a minimum cable length of 1.5 m.

Camping cable reels

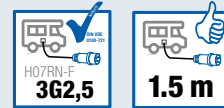

Technical data

- Reel body made from robust, shatterproof special plastic
- Overheat protection and cable guide
- Cable clip to fix the cable on the housing
- Intended for permanent outdoor use
- Tested in accordance with EN 61242, DIN VDE 0620-2-1, DIN EN 50525-2, IEC 60309
- **IP44:** protected against foreign bodies and splash-proof

Xperts camping cable reel

IP44



- With stable, shock-absorbing **X** double-tube frame with star-grip brake, especially suitable for uneven ground
- Frame with ergonomic non-slip 2-component handle
- With CEE plug 230 V, 16 A, 3-pole
- With 2x shock-proof socket outlets 230 V, splash-proof and 1 CEE socket with flap lid 230 V, 16 A, 3-pole

With heavy-duty rubber cable

RN

With CEE plug	Ø mm	PU	EAN	Art. no.
25 m H07RN-F 3G2.5	285	1/48	4011160221767	22176

Camping cable reel

IP44



- Shock-absorbing, stable, galvanised foot frame with parking brake
- Ergonomic handle
- With CEE plug 230 V, 16 A, 3-pole
- With 2x shock-proof socket outlets 230 V, splash-proof and 1 CEE socket flap lid 230 V, 16 A, 3-pole

With heavy-duty rubber cable

RN

With CEE plug	Ø mm	PU	EAN	Art. no.
25 m H07RN-F 3G2.5	285	1/60	4011160101762	10176



Bag for cable reel
Art. no. 12279, page 187



- Shock-absorbing, stable, galvanised foot frame with parking brake
- Ergonomic handle
- Shock-proof plug 230 V, 16 A
- With 2x shock-proof socket outlets 230 V, splash-proof and 1 CEE socket with flap lid 230 V, 16 A, 3-pole

With heavy-duty rubber cable

RN

With safety plug	Ø mm	PU	EAN	Art. no.
25 m H07RN-F 3G2.5	285	1/60	4011160101731	10173



Bag for cable reel
Art. no. 12279, page 187

Camping cable reels

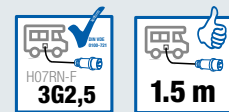

Technical data

- Reel body made from robust, shatter-proof special plastic with ergonomic handle
- Shock-absorbing, stable, galvanised foot frame with parking brake
- Overheat protection and cable guide
- Cable clip to fix the cable on the housing
- Intended for permanent outdoor use
- Tested in accordance with EN 61242, DIN VDE 0620-2-1, DIN EN 50525-2, IEC 60309
- **IP44**: protected against foreign bodies and splash-proof

Camping extension reel

IP44



- With CEE plug 230 V, 16 A, 3-pole
- With 1.5 m power cord with 1x CEE connector with flap lid 230 V, 16 A, 3-pole

With heavy-duty rubber cable

RN

With CEE plug	Ø mm	PU	EAN	Art. no.
25 m H07RN-F 3G2.5 with CEE plug	285	1/60	4011160122705	12270



Bag for cable reel
Art. no. 12279, page 187



- With CEE plug 230 V, 16 A, 3-pole
- With 1.5 m power cord with CEE angled connector with flap lid (230 V, 16 A, 3-pole) and shock-proof socket outlet with flap lid (230 V, 16 A)

With heavy-duty rubber cable

RN

With CEE plug	Ø mm	PU	EAN	Art. no.
25 m H07RN-F 3G2.5 with CEE plug	285	1/60	4011160122743	12274



Bag for cable reel
Art. no. 12279, page 187

Cable reel

IP44



- Shock-proof plug 230 V, 16 A
- With 3 shock-proof socket outlets, splash-proof

With heavy-duty rubber cable

RN

With safety plug	Ø mm	PU	EAN	Art. no.
25 m H07RN-F 3G2.5	285	1/60	4011160102318	10231



Bag for cable reel
Art. no. 12279, page 187



The all-weather protective bag against dirt and rain!

- Made of resistant, dust- and splash-proof outdoor material
- Easy-care and easily washable
- Zip with all-weather-resistant protective coating
- 4 zipper sliders allow the setting of individual openings
- Practical strap with a buckle clip on the top
- Easy packing of the cable reel as the bag can be opened completely
- Pre-punched slots on both sides to pull the cables through
- Pocket size: height 390 mm, width 330 mm, depth 210 mm
- Intended for permanent outdoor use
- Suitable for camping cable reels with the article no. 10173, 10176, 10231, 12270, 12274

Version	Colour	PU	EAN	Art. no.
Bag for camping cable reels	Grey	1	4011160122798	12279

Details overview:



Zipper with all-weather-resistant protective coating and four sliders.



Adjustable strap with buckle clip for easy transport.



Rain protection tabs over pre-punched opening slots for the power cable.



Easy packing as the bag can be opened completely.



Connection facilitated by the four zipper sliders.



Practical cable entries on both sides of the bag.

Camping Duo

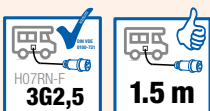

Set consists of:

- 1x CEE camping cable reel (Art. no. 10176) with rubber power cable 25 m H07RN-F 3G2.5 with CEE-plug, 1 CEE socket outlet and 2 shock-proof socket outlets with flap lids
- 1x CEE extension 1.5 m H07RN-F 3G2.5 (Art. no. 61489) with CEE plug and CEE connector with flap lid

EAN: 4011160197000
Art. no. 19700

CEE extensions



Technical data

- Tested in accordance with DIN VDE 0620-2-1, IEC 60309, DIN EN 50525- 2
- **IP44**: protected against foreign bodies and splash-proof

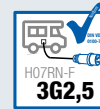

CEE extensions

IP44



- 1x CEE plug 230 V, 16 A, 3-pole
- 1x CEE angled connector 230V, 16A, 3-pole and
1x shock-proof socket outlet 230V, 16 A, waterproof IP44, with flap lid

Heavy-duty rubber cable

RN

With CEE plug	PU	EAN	Art. no.
1.5 m H07RN-F 3G2.5 with CEE angled connector	1	4011160614828	61482



- 1x CEE plug 230 V, 16 A, 3-pole
- 1x CEE connector 230 V, 16 A, 3-pole with flap lid

Heavy-duty rubber cable

RN

With CEE plug	PU	EAN	Art. no.
1.5 m H07RN-F 3G2.5 with CEE connector	1	4011160614897	61489
5 m H07RN-F 3G2.5 with CEE connector	1	4011160613708	61370
10 m H07RN-F 3G2.5 with CEE connector	1	4011160604775	60477
25 m H07RN-F 3G2.5 with CEE connector	1	4011160604799	60479



Bag for extension
Art. no. 12278, page 189



- Extension with RCD protection 30mA
- RCD with undervoltage release as protection against electric voltage
- 1x CEE plug 230 V, 16 A, 3-pole
- 1x CEE connector 230 V, 16 A, 3-pole with flap lid

Heavy-duty rubber cable

RN

With CEE plug	PU	EAN	Art. no.
2x 1.5 m H07RN-F 3G2.5 with CEE connector	1	4011160452246	45224



Bag for extension
Art. no. 12278, page 189



FI/RCD





The all-weather protective bag against dirt and rain!

- Protects extensions against dirt and rain
- Made of resistant, dust- and splash-proof outdoor material
- Easy-care and easily washable
- Zip with all-weather-resistant protective coating
- Easy packing of the extension as the bag can be opened completely
- Pocket size: diameter 360 mm, depth 110 mm
- Bag with long and elastic handle
- Intended for permanent outdoor use
- Suitable for extensions up to 25 m 3G2.5

Version	Colour	PU	EAN	Art. no.
Bag for extensions	Grey	1	4011160122781	12278

Details overview:



Stable and elastic handle for easy transport



Zipper with all-weather-resistant protective coating.



Easy packing as the bag can be opened completely

Camping Set



Set consists of:

- **1x protective bag** for extensions (Art. no. 12278)
- **1x extension 25 m H07RN-F 3G2.5** (Art. no. 60479) with CEE plug and CEE connector
- **1x adapter cord 1.5 m H07RN-F 3G2.5** (Art. no. 60486) with shock-proof plug 2 PE/230 V/16 A and CEE connector
- **1x adapter cord 1.5m H07RN-F 3G2.5** (Art. no. 60488) with CEE-plug 230 V/16 A/3-pole and shock-proof connector 2 PE/230 V/16 A
- **1x LED-torch XT1** (Art.no. 42804)

EAN: 4011160197017
Art. no. 19701



Finger weg! Das gehört Carlo Camper!

Camping, Cars und Caravan: Ihr Ausstatter für alle Fälle

Camping-Shop Musterstraße 10 12345 Musterstadt Tel.01234/56789

Besuchen Sie uns bald wieder: Campingplatz Kuckucksnest im Schwarzwald

Your Camping equipment with individually labelled cables

Do you want your **cable reels or extensions** to advertise your company when being used on the campsite? With our cable labelling service, they can do just that.

We can print the cables for your required products to meet your exact specifications. Whether it's the **name and address of a campsite or a link to your website** – all this increases your advertising impact and ensures more visitors. A labelled line also has the advantage of raising the **inhibition threshold for theft** and thus protecting your property. And **confusion** of property is also **avoided**.

Take advantage of our cable labelling service now.

Here's how it works:

Select the products from this catalogue that you would like us to label for you.

The minimum purchase amount is **100 m cable length**, made up of a combination of any lengths, e.g.:

- Four cable reels each containing 25 m of cable
- Ten extensions each 10 m in length
- Two cable reels each containing 25 m of cable and five extensions each 10 m in length

Silver-grey ink is used for your desired cable printing. The inks we use have a high mechanical durability and are largely abrasion-resistant.

We deliver your printed cables just a few days following printing approval.



Order your customised cable printing now
Art no. 61000 (per metre)

CEE adapter cords

Technical data

- Tested in accordance with DIN VDE 0620-2-1, IEC 60309, DIN EN 50525- 2
- **IP44:** protected against foreign bodies and splash-proof

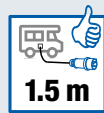

CEE adapter cords

IP44



- 1x shock-proof plug 230 V, 16 A
- 1x CEE connector 230 V, 16 A, 3-pole with flap lid

Heavy-duty rubber cable

RN

With safety plug	PU	EAN	Art. no.
1,5 m H07RN-F 3G2.5 with CEE connector	1	4011160604867	60486



- 1x CEE plug 230 V, 16 A, 3-pole
- 1x shock-proof socket outlet with safety lid 230 V, 16 A

Heavy-duty rubber cable

RN

With CEE plug	PU	EAN	Art. no.
1.5 m H07RN-F 3G2.5 with shock-proof connector	1	4011160604881	60488



- 1x shock-proof plug 230 V, 16 A
- 1x CEE connector 230 V, 16 A, 3-pole with flap lid

Heavy-duty rubber cable

RN

With safety plug	PU	EAN	Art. no.
1.5 m H07RN-F 3G2.5 with CEE angled connector	1	4011160614835	61483



- 1x shock-proof plug 230 V, 16 A
- 1x CEE angled connector 230 V, 16 A, 3-pole and 1x shock-proof socket outlet 230 V, 16 A,, waterproof with flap lid

Heavy-duty rubber cable

RN

With safety plug	PU	EAN	Art. no.
1.5 m H07RN-F 3G2.5 with CEE angled connector	1	4011160604836	60483



- 1x CEE plug 400 V, 16 A, 5-pole
- 1x CEE connector 230 V, 16 A, 3-pole with flap lid

Heavy-duty rubber cable

RN

With CEE plug 400 V	PU	EAN	Art. no.
1.5 m H07RN-F 3G2.5 with CEE connector 230 V	1	4011160613913	61391

International CEE adapter cords



British standard

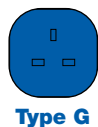

- With 1.5 m PVC cord H05VV-F 3G1.5, orange

Version	PU	EAN	Art. no.
British standard plug BS1363 (230 V, 13 A, 3-pole) and CEE connector with flap lid (230 V, 16 A, 3-pole)	1	4059948002863	660486
CEE plug (230 V, 16 A, 3-pole) and British standard connector BS1363 (230 V, 13 A, 3-pole)	1	4059948002870	660488

Swiss standard

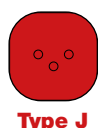

- With 1.5m heavy-duty rubber cable H07RN-F 3G2.5

Version	PU	EAN	Art. no.
SEV plug type 12 (230 V, 10 A, 3pole) and CEE connector with flap lid 230 V, 16 A, 3-pole)	1	4059948003990	760486
CEE plug (230 V, 16 A, 3-pole) and SEV connector type 23 with safety lid (230 V, 16 A, 3-pole)	1	4059948004393	761488

French standard

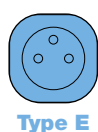

- With 1.5m heavy-duty rubber cable H07RN-F 3G2.5

Version	PU	EAN	Art. no.
NF plug (230 V, 16 A) and CEE connector with flap lid (230 V, 16 A, 3-pole)	1	4011160604867	60486
CEE plug (230 V, 16 A, 3-pole) and NF connector type 23 with safety lid (230 V, 16 A, 2 PE)	1	4059948000296	860488

Italian standard

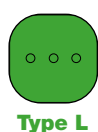

- With 1.5 m heavy-duty rubber cable H07RN-F 3G1.5

Version	PU	EAN	Art. no.
Italian plug type L (16 A) and CEE connector with flap lid (230 V, 16 A, 3-pole)	1	4059948002979	360486
CEE plug (230 V, 16 A, 3-pole) and Italian industrial outlet type L (230 V, 10-16 A)	1	4059948002986	360488



Country overview per connector standard

As some countries use several connector systems, we cannot present a binding overview. Please inform yourself in detail which type you need before you start your journey.

Type B



- Ecuador
- Japan
- Canada
- Colombia
- Cuba
- Mexico
- Panama
- Philippines
- Taiwan
- Thailand
- USA
- Venezuela

Type E

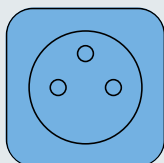

- Belgium
- France
- Morocco
- Monaco
- Poland
- Slovakia
- Czech Republic
- Tunisia

Type F

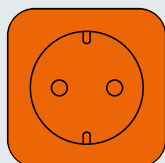

- Bulgaria
- Germany
- Finland
- Greece
- Croatia
- Netherlands
- Norway
- Austria
- Portugal
- Russia
- Sweden
- Spain
- Turkey

Type G

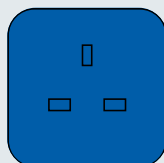

- Abu Dhabi
- Dubai
- Great Britain
- Gambia
- Ghana
- Hong Kong
- India
- Iraq
- Ireland
- Northern Ireland
- Scotland
- Singapore
- Wales
- Cyprus

Type I

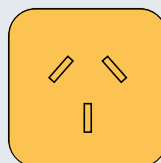

- Argentina
- Australia
- China
- New Zealand
- Samoa
- Uruguay

Type J

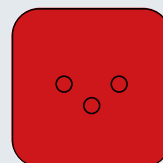

- Switzerland
- Liechtenstein

Type L

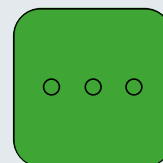

- Ethiopia
- Chile
- Italia
- San Marino
- Vatican City

Travel adapter STECKY

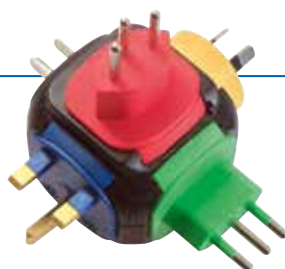

For use in more than 100 countries

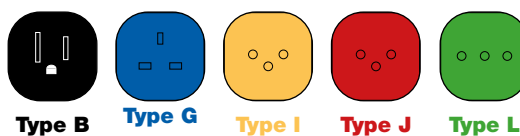

Versions for indoor household appliances

- 5 easily interchangeable country-specific modules
- For safe connection of different plugs
- With ground wire bracket and space-saving travel case

PU	EAN	Art. no.
1	4011160902512	90251

CEE safety box

IP44



- Reliable impact protection and moisture protection for plugs and connectors
- Impossible for plugs and connectors to be accidentally disconnected
- With a solid lock and three keys
- According to its green colour, the safety box is not visible in hedges or grass
- Length: 360 mm, Ø 110 mm
- **IP44:** protected against foreign bodies and splash-proof

Version	PU	EAN	Art. no.
Safety box for CEE plugs 230 V, 16 A, 3-pole	1	4011160487088	48708

Cable winder



- Cable winder for keeping your extensions or cords neat and tidy when storing them
- **For max. 15 m** heavy-duty rubber cable H07RN-F 3G2.5
- Provided with two loops
- Featuring a plug storage holder and two hanging rings
e.g. shock-proof plug and CEE plug 230 V



Version	Colour	PU	EAN	Art. no.
Cable winder for max. 15 m H07RN-F 3G2.5	Blue	1	4011160487095	48709

Battery adapter with cigarette lighter connector



- Allows the connection of all types of equipment through the cigarette lighter directly with the battery (12 V or 24 V)
- 1 m 2x0,75 mm² insulated cables with coloured positive and negative battery terminals

Version	PU	EAN	Art. no.
Battery adapter with cigarette lighter connector	1	4011160423055	42305



MIXO energy meters

Control of power consumption

To avoid bad surprises at the end of your camping trip, always check your power consumption by using the MIXO energy meter.

Easy installation

To correctly record the measured values, connect the energy meter between the power supply and your mobile home. The energy measurement will start as soon as you switch on a device.

Analog display: MID-approved and sealed

MIXO energy meters are only ever fitted with analog displays, which are calibrated in accordance with the specifications of the calibration authority. MIXO energy meters guarantee the manipulation-proof recording of measured values.



Electricity billing? No problem with MIXO energy meters!

In accordance with § 31 of the German Measurement and Calibration Act (MessEG), **only calibrated meters may be used for electricity billing.**

MIXO energy meters comply with the directives of the European Measuring Instruments Directive MID and are approved for **electricity billing**. The use of **non-calibrated energy meters for billing constitutes an offence** punishable by a fine of up to EUR 50000 (§ 60).



More energy meters can be found from page 88.

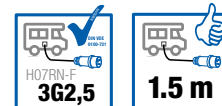

Analog display

MIXO energy meters

IP44

- Housing made from shatterproof special plastic
- Integrated energy meter, **MID-calibrated** in accordance with 2014/32/EU and sealed
- Analogue display 5+1 digits, readable at any time
- Display for a maximum of 99.999,9 kWh, non-resettable
- Operating temperature from -25°C to +55°C
- With heavy-duty rubber cable H07RN-F 3G2.5
- Tested in accordance with DIN EN 50525-2, DIN VDE 0620-2-1, IEC 60309, IEC EN 50470-1
- **IP44**: intended for outdoor use

Version	Cable length	PU	EAN	Art. no.
With CEE plug and CEE connector	2x 1.5 m	1	4011160617485	61748

MIXO CEE combination units

Ideal for travelling



MIXO CEE combination units



Technical data

- Mobile distributors, space-saving and universally applicable
- Housing made from shatterproof special plastic
- Max. load 16 A/approx. 3.5 kW
- No protective device
- Tested in accordance with DIN VDE 0620-2-1, IEC 60309, DIN EN 50525- 2
- **IP44:** protected against foreign bodies and splash-proof



MIXO WESER

Input **16 A**, approx. 3.5 kW

Output



CEE plug 230 V, 16 A, 3-pole

3x shock-proof socket outlets 230 V, 16 A



EAN 4011160604980

Art. no. 60498

MIXO EMS

Input **16 A**, approx. 3.5 kW

Output



CEE plug 230 V, 16 A, 3-pole with 1.5 m H07RN-F 3G2.5 extension

1x shock-proof socket outlet 230 V, 16 A
2x CEE sockets 230 V, 16 A, 3-pole



EAN 4011160604966

Art. no. 60496

MIXO SAALE

Input **16 A**, approx. 3.5 kW

Output



CEE plug 230 V, 16 A, 3-pole

2x shock-proof socket outlets 230 V, 16 A
1x CEE socket 230 V, 16 A, 3-pole
1x CEE connector 230 V, 16 A, 3-pole with 1.5 m H07RN-F 3G2.5 extension



EAN 4011160604973

Art. no. 60497

Caravan adapters

Input **16 A**, approx. 3.5 kW

Output



CEE plug 230 V, 16 A, 3-pole

1x shock-proof socket outlet 230 V, 16 A



EAN 4011160604942

Art. no. 60494

Xperts
camping cable reel



Multi socket outlets



Technical data

- With illuminated on/off switch and self-locking safety flap lids
- Suitable for wall attachment
- With heavy-duty rubber cable H07RN-F 3G1.5
- Tested in accordance with DIN VDE 0620-2-1, IEC 60309, RN-F tested in accordance with DIN EN 50525-2
- **IP44**: protected against foreign bodies and splash-proof

Multiple socket outlets with switch

IP44

- With **CEE plug** 230 V, 16 A, 3-pole

Heavy-duty rubber cable

RN

Version	Cable	EAN	Art. no.
3-way multi socket outlet	1.5 m H07RN-F 3G1.5	4011160386183	38618
5-way multi socket outlet	4.5 m H07RN-F 3G1.5	4011160386190	38619



More multi socket outlets can be found on page 57 or from page 212.



All models have **shock-proof socket outlets** with safety flap lids and illuminated, splash-proof **on/off switch**. There are also pre-drilled holes for attachment.



No mutual obstruction between the connected plugs thanks to the **45° rotated socket inserts**.



STECKY



Ergonomic handle offers an excellent catch, even with gloves



Velcro fastener for fixing the cord to the frame



Powder-coated metal frame with edge protection and with cable rewriter



STECKY DUO with 2 USB-Ports to recharge mobile phones, handlamp batteries etc.



STECKY DUO

STECKY CEE combination units



Technical data

- Robust housing made from shatterproof special plastic
- Stable metal frame with edge protection
- With large ergonomic carry handle and cable winder
- Tested in accordance with DIN VDE 0620-2-1, IEC 60309, EN 61439-4, DIN EN 50525-2
- **IP44**: protected against foreign bodies and splash-proof



STECKY CEE combination units

IP44

STECKY 14

- Dimensions (W x H x D): 230 x 417 x 220 mm

Input 16 A, approx. 3.5 kW



CEE plug 230 V, 16 A, 3-pole
With 2.5 m H07RN-F 3G2.5
Heavy-duty rubber cable

Output

4x shock-proof socket outlets 230 V, 16 A
2x CEE sockets 230 V, 16 A, 3-pole



Protection

None



EAN 4011160608698
Art. no. 60869

STECKY DUO CEE combination units

IP44

STECKY DUO 5

- Dimensions (W x H x D): 400 x 450 x 252 mm

Input 16 A, approx. 3.5 kW



CEE plug 230 V, 16 A, 3-pole
With 3.4 m H07RN-F 3G2.5
Heavy-duty rubber cable

Output

7x shock-proof socket outlets 230 V, 16 A
4x CEE sockets 230 V, 16 A, 3-pole
2x USB ports 5 V / 2.1 A



Protection

1x RCD 25 A, 30 mA,
type A



FI/RCD



EAN 4011160609350
Art. no. 60935

More STECKY combination units
can be found from page 130.

CEE plugs and connectors



Technical data

- High quality plugs and connectors with shock-resistant, splash-proof housing
- Cable connection capacity of up to **3G2.5**
- Tested in accordance with DIN VDE 0620-2-1, IEC 60309
- **IP44**: protected against foreign bodies and splash-proof



Version	PU	EAN	Art. no.
CEE plug 230 V, 16 A , 3-pole, 6 h	5	4011160604706	60470
CEE plug 230 V, 32 A , 3-pole, 6 h	1	4011160605901	60590



Version	PU	EAN	Art. no.
CEE angled plug 230 V, 16 A, 3-pole, 6 h	1	4011160614811	61481



Version	PU	EAN	Art. no.
CEE wall-mounting inlet 230 V, 16 A, 3-pole, 6 h	5	4011160604737	60473



Version	PU	EAN	Art. no.
CEE connector 230 V, 16 A, 3-pole , 6 h	5	4011160604713	60471
CEE connector 230 V, 32 A, 3-pole , 6 h	1	4011160605925	60592



Version	PU	EAN	Art. no.
CEE angled connector 230 V, 16 A, 3-pole, 6 h With self-locking flap lid	5	4011160604751	60475



Version	PU	EAN	Art. no.
CEE angled connector 230 V, 16 A, 3-pole With integrated shock-proof socket outlet	5	4011160604744	60474



Version	PU	EAN	Art. no.
CEE wall-mounting socket outlet 230 V, 16 A, 3-pole, 6 h	5	4011160604720	60472

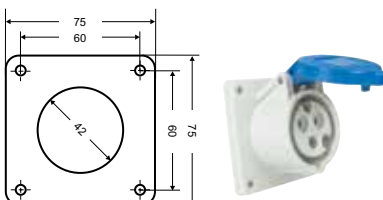

- Flange size (H x W) in mm: 75x75
- Hole spacing (H x W) in mm: 60x60
- Mounting depth in mm: 33

Version	PU	EAN	Art. no.
CEE panel mounting socket outlet 230 V, 16 A, 3-pole, 6 h	1	4011160604805	60480

CEE caravan power inlets



Technical data

- High quality power inlet for self-assembly
- CEE 230 V, 16 A, 3-pole, 6 h
- Tested in accordance with IEC 60309
- **IP44**: protected against foreign bodies and splash-proof



© JFSpic

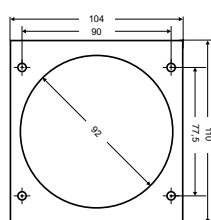

- CEE power supply inlet 230 V, 16 A, 3-pole with flap lid
- Flange size (H x W) in mm: 110x104
- Hole spacing (H x W) in mm: 90x77.5
- Mounting depth in mm: 82

Colour	PU	EAN	Art. no.
White	1	4011160604843	60484
Anthracite grey	1	4011160614927	61492
Black	1	4011160614934	61493

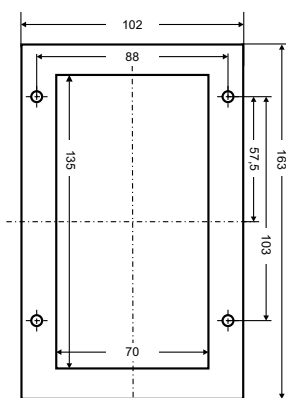

- Foldable CEE power supply inlet 230 V, 16 A, 3-pole with flap lid
- Flange size (H x W) in mm (closed): 163x102
- Hole spacing (H x W) in mm: 103x88
- Mounting depth in mm: 62

Colour	PU	EAN	Art. no.
White	1	4011160614637	61463

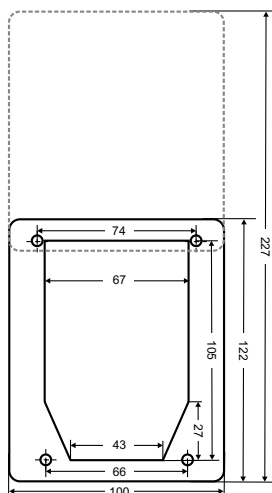

- CEE power supply inlet 230 V, 16 A, 3-pole with hinged lid
- Flange size (H x W) in mm (closed): 112x100
- Flange size (H x W) in mm (open): 227x100
- Hole spacing (H x W) in mm: 74/66x105
- Mounting depth in mm: 119

Colour	PU	EAN	Art. no.
White	1	4011160614804	61480
Black	1	4011160614620	61462

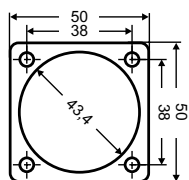

- Flange size (H x W) in mm: 50x50
- Hole spacing (H x W) in mm: 38x38
- Mounting depth in mm: 28
- Suitable for indoor use

Versions for indoor use

	PU	EAN	Art. no.
Shock-proof socket outlet 230 V, 16 A, grey	1	4011160450846	45084
Shock-proof socket outlet 230 V, 16 A, black	1	4011160450815	45081

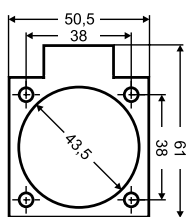

- Twin USB socket 5 V/2.1 A DC
- Flange size (H x W) in mm: 61x50.5
- Hole spacing (H x W) in mm: 38x38
- Mounting depth in mm: 34
- IP54: suitable for outdoor use

Version 230 V

	PU	EAN	Art. no.
USB flanged socket with twin USB socket	1	4011160450891	45089



- Delivery including 0.6 m connecting wires with built-in fuse
- 2 USB sockets 1x 5 V/1 A und 1x 5 V/2.1 A
- with protective cap
- Flange size (H x W) in mm: 43x46
- Hole spacing in mm: 34
- Mounting depth in mm: 34
- Suitable for indoor use

Version 12 V

	PU	EAN	Art. no.
USB flanged socket with two USB ports, white	1	4011160614644	61464
USB flanged socket with twin USB socket, black	1	4011160614996	61499

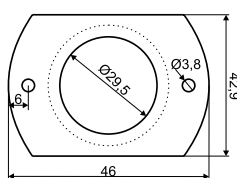

Protective devices and cables

IP44



- Miniature circuit breaker in a white ABS housing
- For caravan wall-mounting
- Dimensions (H x WxD): 131x50x80 mm
- MCB on 2 poles, 230 V/10 A, C-curve

Version	PU	EAN	Art. no.
MCB 10 A, C-curve	1	4011160615641	61564



- Residual Current Device in a white ABS housing
- For caravan wall-mounting
- Dimensions (H x WxD): 131x50x80 mm
- RCD 25 A, 30 mA, 2-pole, type A

Version	PU	EAN	Art. no.
RCD	1	4011160615658	61565

Wiring solutions

- For the wiring of caravans, trailers and motorhomes



Version	Colour	PU	EAN	Art. no.
PVC cable H05VV-F 7x1.0 per metre	Black	1	4011160708992	70899
2 m PVC cable H05VV-F 7x1.0	Black	1	4011160718922	71892
5 m PVC cable H05VV-F 7x1.0	Black	1	4011160718953	71895
10 m PVC cable H05VV-F 7x1.0	Black	1	4011160718908	71890
5 m H07V-K 1.5 mm²	Blue	1	4011160300400	30040
5 m H07V-K 2.5 mm²	Blue	1	4011160300424	30042
5 m H07V-K 6.0 mm²	Blue	1	4011160300455	30045
5 m H07V-K 1.5 mm²	Red	1	4011160300417	30041
5 m H07V-K 2.5 mm²	Red	1	4011160300431	30043
5 m H07V-K 6.0 mm²	Red	1	4011160300448	30044
5 m PVC twin cable H03VH-H 2x0.75 mm²	White	1	4011160300509	30050
Heavy-duty rubber cable H07RN-F 3G2.5 per metre	Black	1	4011160100185	10018

Caravan plugs, sockets and adapters



We have the solution!

The problem: Your trailer socket has a 13-pin connection and your trailer a 7-pin plug?

The solution: Our caravan plug, socket, adapter and converter range offers all possible combinations.



- Connection of the 13-pin sockets to 7-pin trailer plug adapter
- No need for dragging cables any longer

Version	PU	EAN	Art. no.
Universal short adapter	1	4011160604690	60469



- Connection of the 13-pin sockets to 7-pin trailer plug adapter
- No need for dragging cables any longer

Version	PU	EAN	Art. no.
Universal mini adapter	1	4011160604393	60439



1

- Round, with flap lid and contact for rear fog light
- For mounting



2

Version	PU	EAN	Art. no.
1 13-pin socket	1	4011160614743	61474
2 7-pin socket	1	4011160614736	61473



1

- Connects trailer road lights to towing vehicle
- For cables of diameters from 8.5–10 mm
- Designed in accordance with DIN ISO 1724



2

Version	PU	EAN	Art. no.
1 Plug 7-pin	1	4011160604621	60462
2 Plug 13-pin	1	4011160604645	60464



1

- Connects trailer road lights to towing vehicle
- For cables of diameters from 8.5–10 mm
- Designed in accordance with DIN ISO 1724



2

Version	PU	EAN	Art. no.
1 Connector 7-pin	1	4011160604638	60463
2 Connector 13-pin	1	4011160604669	60466



© welcomia

Caravan adapter cords



1

- With a 0.6 m automotive PVC cable 7×1 mm²

Version	PU	EAN	Art. no.
1 Adapter conversion lead 13-pin plug to 7-pin connector	1	4011160604676	60467
2 Adapter conversion lead 7-pin plug to 13-pin connector	1	4011160604683	60468



2



- Retractable spiral lead with 13-pin plug and 7-pin plug
- With 1 m automotive PVC cable 7×1

Version	PU	EAN	Art. no.
Retractable lead	1	4011160614750	61475

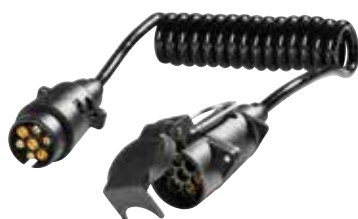

- Retractable spiral lead with 7-pin connector and 7-pin plug
- With 2 m automotive PVC cable 7×1

Version	PU	EAN	Art. no.
Extensions	1	4011160614767	61476



With our product range, you are always well equipped on the road!



- Testing of the wiring circuits on the car or trailer
- Handy test device for finding cable line defects
- LED Indicators will show green when function is tested and correctly wired, or red if a fault is present
- Applicable for all 7-pin plugs and connectors
- Internal battery supply, no external power source necessary
- Operation with 9 V battery (not included)

Version	PU	EAN	Art. no.
7-pin socket caravan circuit tester	1	4011160614729	61472

Socket wiring diagram

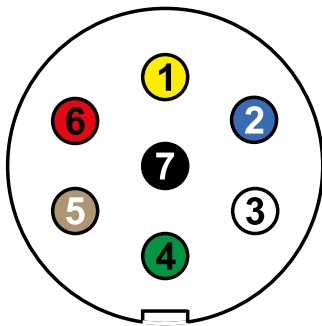

7-pin (socket)

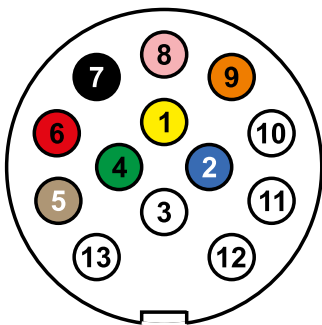

13-pin (socket)

Sockets mirror-inverted

PIN number	Label	Colour	7-pin	13-pin
1	L	Yellow	Left turn	Left turn
2	54g	Blue	Fog light	Fog light
3	31	White	Earth	Earth
4	R	Green	Right turn	Right turn
5	58R	Brown	Right tail/side light	Right tail/side light
6	54	Red	Brake/stop lights	Brake/stop lights
7	58L	Black	Left tail/side light	Left tail/side light
8	ZR	Grey/pink		Reversing light
9	30	Brown/blue Orange		12 V permanent from batt.
10				12 V ignition on
11				Spare
12				Spare
13	31	Black/white White/red		Earth



13



Multi socket outlets & multiplugs **213-221**

Timers **222**

Remote-controlled sockets **223**

Energy cost meter **223**

Hazard alarms **224-227**

Water hose rewinding reels **228-229**

Safety box **230**

Plug stakes **231**

Ice-stop heating cables **232**

Home and garden





Flat plug

Practical design for hard-to-access locations

When a flat plug is plugged into a socket, it will have a **particularly flat** fit against the socket compared to conventional straight shock-proof plugs or even angled plugs. This makes flat plugs ideal **for hard-to-access locations or tight spaces**. Furniture such as wardrobes, chests etc. can be pushed right up against the wall thanks to the flat design. A **foldable tab** on the back of the flat plug means that it is still easy to remove the plug from the socket.



Extremely flat plug fit; plug protrudes from the socket by just 7 mm.



Foldable bracket for easy removal from the socket.

Extensions with flat plugs can be found on page 61.
Flat plugs for self-assembly can be found on page 79.

Multi socket outlets with flat plug

IP20



- With 2 m PVC cable H05VV-F 3G1.5 and shock-proof angle flat plug
- Sockets rotated 45°, with shutter
- With switch and indicator light
- 230 V, 16 A, max. 3500 W

Version	Colour	PU	EAN	Art. no.
3-way multi socket outlet 2 m power cord	White	10	4011160113918	11391
3-way multi socket outlet 2 m power cord	Black	10	4011160113925	11392
5-way multi socket outlet 2 m power cord	White	10	4011160113932	11393
5-way multi socket outlet 2 m power cord	Black	10	4011160113949	11394



Illuminated on/off switch

45° rotated sockets

provide space for various types of shock-proof plugs.

3-way and 6-way multi socket outlets

IP20



- Screwed, no power cord
- Sockets rotated 45°, with shutter
- Suitable for wall attachment
- 230 V, 16 A, max. 3500 W

Version	Colour	PU	EAN	Art. no.
3-way No power cord	White	10	4011160117312	11731
3-way No power cord	Black	10	4011160117329	11732
6-way No power cord	White	5	4011160117114	11711
6-way No power cord	Black	5	4011160117121	11712

3-way multi socket outlet

IP20



- With PVC cable H05VV-F 3G1.5 and shock-proof angle plug
- Sockets rotated 45°
- 230 V, 16 A, max. 3500 W

Version	Colour	PU	EAN	Art. no.
3-way 1.4 m power cord, with shutter	White	10	4011160139116	13911
3-way 1.4 m power cord, with surge protection	White	10	4011160136917	13691
3-way 1.4 m power cord, with shutter	Black	10	4011160139123	13912
3-way 1.4 m power cord, with surge protection	Black	10	4011160136924	13692
3-way 3 m power cord, with shutter	White	10	4011160113314	11331
3-way 3 m power cord, with shutter	Black	10	4011160113321	11332

3-way multi socket outlet with switch

IP20



- With PVC cable H05VV-F 3G1.5 and shock-proof angle plug
- Sockets rotated 45°, with shutter
- With switch and indicator light
- 230 V, 16 A, max. 3500 W

Version	Colour	PU	EAN	Art. no.
3-way 1.4 m power cord	White	10	4011160113611	11361
3-way 1.4 m power cord	Black	10	4011160113628	11362
3-way 5 m power cord	White	10	4011160113710	11371
3-way 5 m power cord	Black	10	4011160113727	11372

3-way and 6-way multi socket outlets with spiral cord

IP20



- With spiral cord H05VV-F 3G1.5 and shock-proof angle plug
- Sockets rotated 45°, with shutter
- Suitable for wall attachment
- 230 V, 16 A, max. 3500 W

Version	Colour	PU	EAN	Art. no.
3-way 2.5 m spiral cord	White	10	4011160114311	11431
3-way 2.5 m spiral cord	Black	10	4011160114328	11432
6-way 2.5 m spiral cord	White	10	4011160114618	11461
6-way 2.5 m spiral cord	Black	10	4011160114625	11462

4-way Quadro socket

IP20

- With PVC cable H05VV-F 3G1.5 and shock-proof angle plug
- Sockets with shutter
- 230 V, 16 A, max. 3500 W

Version	Colour	PU	EAN	Art. no.
4-way 1.4 m power cord	White	10	4011160144110	14411

5-way multi socket outlet with switch

IP20

- With PVC cable H05VV-F 3G1.5 and shock-proof angle plug
- Sockets rotated 45°, with shutter
- With switch and indicator light
- 230 V, 16 A, max. 3500 W

Version	Colour	PU	EAN	Art. no.
5-way 1.4 m power cord	White	10	4011160350115	35011
5-way 1.4 m power cord	Black	10	4011160350122	35012

6-way multi socket outlet

IP20

- With PVC cable H05VV-F 3G1.5 and shock-proof angle plug
- Sockets rotated 45°, with shutter
- 230 V, 16 A, max. 3500 W

Version	Colour	PU	EAN	Art. no.
6-way 1.4 m power cord	White	10	4011160116117	11611
6-way 1.4 m power cord	Black	10	4011160116124	11612
6-way 3 m power cord	White	10	4011160116315	11631
6-way 3 m power cord	Black	10	4011160116322	11632

6-way multi socket outlet with switch

IP20

- With PVC cable H05VV-F 3G1.5 and shock-proof angle plug
- Sockets rotated 45°
- With switch and indicator light
- 230 V, 16 A, max. 3500 W

Version	Colour	PU	EAN	Art. no.
6-way 1.4 m power cord	White	10	4011160115011	11501
6-way 1.4 m power cord with shutter	White	10	4011160115110	11511
6-way 1.4 m power cord with surge protection	White	10	4011160166914	16691
6-way 1.4 m power cord with shutter	Black	10	4011160115127	11512
6-way 1.4 m power cord with surge protection	Black	10	4011160166921	16692
6-way 5 m power cord with shutter	White	5	4011160116711	11671
6-way 5 m power cord with shutter	Black	5	4011160116728	11672

Shock-proof socket outlet with on/off switch

IP20



- No standby costs for your electrical devices
- Convenient and space-saving
- Simple operation (just plug in the device and you're done)
- Switch with indicator light, switches on 1 pole
- 230 V, 16 A, max. 3500 W

Version	Colour	PU	EAN	Art. no.
1-way Shock-proof socket outlet with shutter	White	20	4011160450372	45037

Multi socket outlet 2+2

IP20



- 2x Euro plugs, 2x shock-proof plugs
- With PVC cable H05VV-F 3G1.5 and shock-proof angle plug
- Sockets rotated 45°, with shutter
- 230 V, 16 A, max. 3500 W

Version	Colour	PU	EAN	Art. no.
2+2 1.4 m power cord	White	10	4011160352119	35211
2+2 1.4 m power cord	Black	10	4011160352126	35212

Multi socket outlet 6+3 with switch

IP20



- 6x Euro plugs, 3x shock-proof plugs
- With PVC cable H05VV-F 3G1.5 and shock-proof angle plug
- Sockets rotated 45°, with shutter
- With switch and indicator light
- 230 V, 16 A, max. 3500 W

Version	Colour	PU	EAN	Art. no.
6+3 1.4 m power cord	White	10	4011160390111	39011



2-way Euro plug

IP20



- Convenient and space-saving
- For connecting 2 Euro plugs to a shock-proof socket outlet
- 230 V, 16 A

Version	Colour	PU	EAN	Art. no.
2-way Euro socket with shutter	White	10	4011160482113	48211
2-way Euro socket with shutter	Black	10	4011160482120	48212

3-way Euro plug

IP20



- Convenient and space-saving
- For connecting 3 Euro plugs to a shock-proof socket outlet
- 230 V, 16 A

Version	Colour	PU	EAN	Art. no.
3-way Euro socket with shutter	White	10	4011160483110	48311
3-way Euro socket with shutter	Black	10	4011160483127	48312

4-way Euro plug

IP20

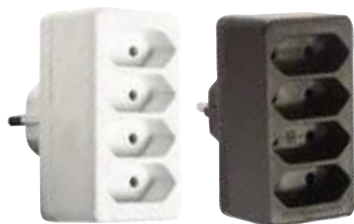

- Convenient and space-saving
- For connecting 4 Euro plugs to a shock-proof socket outlet
- 230 V, 16 A

Version	Colour	PU	EAN	Art. no.
4-way Euro socket with shutter	White	10	4011160484117	48411
4-way Euro socket with shutter	Black	10	4011160484124	48412

Euro plug 2+1

IP20



- Convenient and space-saving
- For connecting 2 Euro plugs and a shock-proof plug to a shock-proof socket outlet
- 230 V, 16 A, max. 3500 W

Version	Colour	PU	EAN	Art. no.
2+1 Euro and shock-proof socket outlets with shutter	White	10	4011160491115	49111
2+1 Euro and shock-proof socket outlets with shutter	Black	10	4011160491122	49112

An overview of all details

Valuable electrical devices such as computers or TV systems can be damaged by surges that occur as a result of faulty switching operations, fluctuations in the power grid or an indirect lightning strike. The **FLASH multi socket outlets** with surge protection protect the electronic components in the connected devices, thereby offering the necessary **protection against excessive electrical voltages**.



High-quality cable
with a length of 1.5 m

Stable, flame-proof housing
in an elegant design

Illuminated on-/off switch

Surge protection:
The integrated gas discharge tube and high-frequency filter provide all sensitive electronic components with safe protection

Shock-proof socket outlets
With shutter, in 45° arrangement

Intelligent cable guide
For professional cable management



Also suitable for wall mounting



Art. no 18670
Available with hand/footswitch



Art. no 18211
Available with USB charging adapter 5 V/2400 mAh



FLASH multi socket outlets

Technical data

- With surge protection: 230 V, 16 A, 3.5 kW
- Type 3 SPD, U_c: 250 V
- U_{oc}: 2.5 kV (L-N) / 5.0 kV (L/N-PE)
- Up: 1.8 kV (L-N) / 2.5 kV (L/N-PE)
- Response time: <1 ns
- **IP20**: for indoor use

FLASH multi socket outlets with surge protection

IP20



- With PVC cable H05VV-F 3G1.5 and shock-proof angle plug
- Sockets rotated 45°, with shutter
- With surge protection

Version	Colour	PU	EAN	Art. no.
3-way 1.5 m power cord	White	1	4011160186639	18663
5-way 1.5 m power cord	White	1	4011160186653	18665
6-way 1.5 m power cord	White	1	4011160186660	18666
9-way 1.5 m power cord	White	1	4011160186691	18669

FLASH multi socket outlets with USB socket

IP20



- 6-way multi socket outlet with 2 USB sockets 5 V/2000 mAh
- With PVC cable H05VV-F 3G1.5 and shock-proof angle plug
- Sockets rotated 45°, with shutter

Version	Colour	PU	EAN	Art. no.
6-way 1.5 m power cord, no surge protection	White	1	4011160182129	18212

FLASH multi socket outlet with hand/footswitch

IP20



- 6-way multi socket outlet with separate hand/footswitch with indicator light
- 1 m control cable H03VV-F 3G0.5 to the hand/footswitch
- 1.5 m PVC cable H05VV-F 3G1.5 and shock-proof angle plug
- Sockets rotated 45°, with shutter

Version	Colour	PU	EAN	Art. no.
6-way 1.5 m power cord, no surge protection	White	10	4011160186707	18670

FLASH Master/Slave multi socket outlet

IP20



- 1 x Master socket and 5x Slave sockets
- **Master/Slave function:** all devices in the Slave sockets are automatically switched when the device's on/off switch (in the Master socket) is pressed
- With PVC cable H05VV-F 3G1.5 and shock-proof angle plug
- Sockets rotated 45°, with shutter
- With indicator light

Version	Colour	PU	EAN	Art. no.
6-way 1.5 m power cord, no surge protection	White	10	4011160186721	18672

Adapters

IP20



Version	Colour	PU	EAN	Art. no.
Surge protection adapter	White	1	4011160186110	18611
USB charging cable 5 V/2400 mAh (no surge protection)	White		4011160182112	18211

An overview of all details

Important components of valuable electrical devices can be damaged by excessive electrical voltages caused by faulty switching operations, fluctuations in the power grid or an indirect lightning strike. The **ALUX multi socket outlets with surge protection provide the connected devices with the necessary protection**. Gas discharge tubes and high-frequency filters remove the excessive electrical voltages, thereby protecting sensitive electronic components.

The extremely stable die-cast aluminium housing protects the ALux multi socket outlets from harmful mechanical influences and guarantees excellent durability.





ALUX multi socket outlets

Technical data

- With surge protection: 230 V, 16 A, 3.5 kW
- Type 3 SPD, U_c: 250 V
- U_{oc}: 2.5 kV (L-N) / 5.0 kV (L/N-PE)
- U_p: 1.8 kV (L-N) / 2.5 kV (L/N-PE)
- Response time: <1 ns
- **IP20**: for indoor use

ALUX multi socket outlets with surge protection

IP20



- With PVC cable H05VV-F 3G1.5 and shock-proof angle plug
- Sockets rotated 45°, with shutter
- With surge protection

Version	Colour	PU	EAN	Art. no.
4-way 1.5 m power cord	Black	1	4011160183645	18364
6-way 1.5 m power cord	Black	1	4011160183669	18366
8-way 1.5 m power cord	Black	1	4011160183683	18368
10-way 1.5 m power cord	Black	1	4011160183607	18360



ALUX table multi socket outlet with USB connections

IP20



- Fastening straps for secure assembly onto tables and worktops
- 4-way multi socket outlet with 2 USB sockets 5 V/2000 mAh
- With PVC cable H05VV-F 3G1.5 and shock-proof angle plug
- Sockets rotated 45°, with shutter
- With surge protection

Version	Colour	PU	EAN	Art. no.
4-way 1.5 m power cord	Black	1	4011160183614	18361



Timers



Mechanical timers

The moving rocker arms make it possible to set a switching distance of 15 or 30 min (dependent upon model).

Digital timers

State-of-the-art microprocessors ensure accurate programming to the nearest minute. It is even possible to program automatically triggering random intervals (e.g. to protect against break-ins).

Benefits:

- Extremely simple operations
- High levels of quality and reliability
- All connected electrical devices can be reliably switched on and off
- Precise control of all types of electrical devices
- Energy-saving

Technical data

- Connection 230 V, 16 A, max. 3500 W
- Tested in accordance with DIN VDE 0620-2-1, EN 60739
- **IP20:** for indoor use
- **IP44:** splash-proof sockets with robust housing for use in damp locations or outdoors



Art. no. 24030



Art. no. 24031



Art. no. 24032



Art. no. 24033

Timers for outdoor use



IP44

Version	PU	EAN	Art. no.
Mechanical daily timer, 96 switching times	1	4011160240317	24031
Digital weekly timer, 8 programs	1	4011160240331	24033

Timers for indoor use



IP20

Version	PU	EAN	Art. no.
Mechanical daily timer, 48 switching times	1	4011160240300	24030
Digital weekly timer, 8 programs	1	4011160240324	24032

Set of 3 remote-controlled sockets

IP20



- Remote-controlled sockets for extra convenience when switching electrical devices such as TVs, computers, hi-fi equipment etc. on and off.
- Remote control with a range of up to 30 metres
- Sockets can be selected individually or simultaneously
- Receivers can be positioned hidden behind cupboards etc.
- Particularly well-suited for the operation of hard-to-access electrical devices
- Simple handling: no installation required
- **IP20:** for indoor use

Version	Colour	PU	EAN	Art. no.
Set of 3 remote-controlled sockets	White	1	4011160240805	24080

Energy cost meter

IP20



- Used to calculate the operating costs and reduce the energy consumption of household appliances
- Helps detect energy guzzlers, thereby reducing electricity costs and carbon dioxide emissions
- Measures voltage, current, amount of electricity and CO₂
- 4-digit digital display
- Parameters:

Measurement range for current:	0 to 9,999 kWh
Measurement range for CO ₂ :	0 to 9,999 KG
Measurement accuracy:	+/- 0.5 %
Operating temperature:	-10 to +50°C
Humidity:	0% to 90%
- 230 V, 16 A, 50 - 60 Hz, max. 3500 W
- **IP20:** for indoor use

Version	Colour	PU	EAN	Art. no.
Energy cost meter	White	1	4011160240515	24051



Smoke detectors

The majority of fire victims die at night in their own homes. And the real danger isn't so much the fire but the smoke.

Smoke detectors save lives – the loud signal tone provides a timely warning of the risk of fire even when you're asleep, and gives you the necessary head start to get yourself and your family to safety.



Heat detectors

Heat detectors are used in places where smoke detectors cannot be used due to moisture, dust or steam.

They are the ideal solution for areas such as basements, attics, kitchens and bathrooms. They can even be used in very humid areas in temperatures of 55°C and over.



Water detectors

The water detector has a special sensor to issue a warning if moisture is detected. Whether caused by a pipe break, an overflowing bathtub or washing machine or a tap that's been left running - as soon as moisture is detected by the water detector, a loud signal tone will sound.

This allows you to take action promptly in the event of even small floods.



CO and gas detectors

CO detectors provide a warning of carbon monoxide (CO) - an invisible, odourless and tasteless gas. CO impedes the blood's oxygen intake, which can very quickly cause unconsciousness and death by suffocation after just a few minutes.

Gas detectors provide you with a warning of any escaping gas from an oven, hob, gas bottle or other potential hazards, making them important life-saving devices.

Smoke detector H-AL 9000 / H-AL 13000

IP20



- Photoelectric detector
- H-AL 9000, 9 V battery included
- H-AL 13000, 1x 3 V CR123A lithium battery (10 years) included, non-replaceable
- Warning tone to indicate low battery status
- Visual display (red) of test function with test button for function check
- Suitable for wall or ceiling installation
- Safety clip (prevents installation without battery)
- Height approx. 37 mm, diameter 100 mm
- Fastening material included
- Tested in accordance with EN 14604
- H-AL 13000 tested in accordance with VdS 3131
- **IP20:** for indoor use



Version	PU	EAN	Art. no.
H-AL 9000 with carbon-zinc battery (1-year operating time)	1	4011160904004	90400
H-AL 13000 with li-ion battery (10-year operating time) VdS	1	4011160904172	90417



85 dB



20-40m²



9V incl.

Radio-controlled smoke detector H-AL 9600

IP20



- Photoelectric detector
- Radio link (433 MHz)
- Wireless distance between two devices: max. 30 m
- Up to 30 smoke detectors can be connected
- Two alkaline AA batteries included
- Warning tone to indicate low battery status
- Visual display (red) of test function with test button for function check
- Suitable for wall or ceiling installation
- Safety clip (prevents installation without batteries)
- Height: 36 mm, diameter: 120 mm
- Tested in accordance with EN 14604
- **IP20:** for indoor use



85 dB



30m

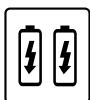

2xAA incl.

Version	PU	EAN	Art. no.
H-AL 9600 with alkaline batteries (1-year operating time)	1	4011160904127	90412

Heat detector H-AL 3000

IP20



85 dB



9V incl.

- Suitable for closed rooms where a smoke detector would be unsuitable due to dust, steam or exhaust gases
- Humidity range: 10 % to 85 %
- Temperature range: 0°C to 60°C
- Temperature triggering: from 55°C
- 9 V battery included
- Recommended monitoring area: 200 qm
- Height: 37.5 mm, diameter: 107 mm
- Suitable for wall or ceiling installation
- Fastening material included
- **IP20:** for indoor use



Version	PU	EAN	Art. no.
H-AL 3000 with carbon-zinc battery (1-year operating time)	10	4011160904059	90405

Gas detector H-AL 6000

IP20



85 dB



20-40m²



9V incl.

- For gas types: butane, propane, methane, natural gas
- Humidity range: 10 % to 90 %
- Temperature range: - 10°C to + 50°C
- Height: 37.5 mm, diameter: 107 mm
- 220 V charger and 9V battery included (operation over 220 V, 9 V backup)
- Fastening material included
- **IP20:** for indoor use



Version	PU	EAN	Art. no.
H-AL 6000 with charger and 9 V battery (as backup)	10	4011160904073	90407

CO detector H-AL 14000

IP20



85 dB



20-40m²



2xAA incl.

- With function display
- Electrochemical sensor
- Signal tone with additional flashing LED
- 2x AA batteries included
- Warning tone to indicate low battery status and visual display
- Ambient conditions: -10°C to +40°C temperature, up to 95% humidity
- Suitable for wall or ceiling installation, fastening material included
- Tested in accordance with EN 50291
- **IP20:** for indoor use



Version	PU	EAN	Art. no.
H-AL 14000	10	4011160904080	90408

Water detector H-AL 7000

IP65



- Temperature range: -4°C to 38°C
- 9 V battery included
- Warning tone to indicate low battery status
- Height: 33 mm, diameter: 85 mm
- **IP65:** dust-tight and jet-water-proof



Version	PU	EAN	Art. no.
H-AL 7000 with carbon-zinc battery	10	4011160904035	90403



85 dB



9V incl.

Magnetic mount for hazard alarm

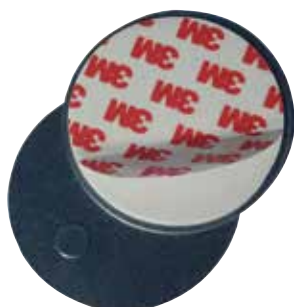

- Extremely simple installation: Strong adhesive pads for secure attachment of the magnets
- Makes it easier to replace the batteries and carry out the function test
- Suitable for smoke or heat detectors with a minimum diameter of 80 mm
- No drilling required: tool-free installation
- Also suitable for mobile homes, boats etc.

Version	PU	EAN	Art. no.
Self-adhesive magnetic mount	1	4011160904066	90406



Automatic water hose rewinding reel

Tidied away yet always to hand
on the wall





Automatic water hose rewinding reel

Technical data

- Reel body made from robust, shatter-proof special plastic: extremely sturdy design
- Can be swivelled 180° on the wall attachment
- With handle for easy carrying
- No more tiresome winding in of the water hose. Simply pull gently on the hose and the automatic rewinding mechanism will wind the entire hose back into the winder housing.
- The fixed locking mechanism on the hose ensures that the hose sprayer cannot be pulled into the housing when the hose is being wound in.
- Includes heavy-duty dowel/screws for wall attachment

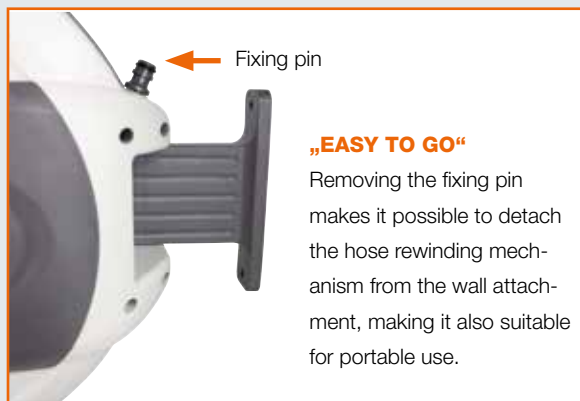

180° swivelling to the left and right

Automatic water hose rewinding reel

IP44

NEW



- Knitted PVC-textile hose 11.5 x 15.8 mm: 2 m with connecting piece and 20 m with sprayer
- Can be swivelled 180° on the wall attachment and with “EASY TO GO” function
- Colour: grey
- **IP44**: suitable for use in the garden

Knitted PVC-textile hose

PVC

Version	PU	EAN	Art. no.
20 m knitted PVC-textile hose with sprayer	1	4011160126161	12616
2 m knitted PVC-textile hose with connecting piece			



Water hose



- Knitted PVC-textile hose with stabilising polyester cord mesh insert
- Colour: yellow
- Cadmium-free, lead-free and barium-free

Version	Ø	PU	EAN	Art. no.
50 m knitted PVC-textile hose	1/2"	1	4011160127304	12730
25 m knitted PVC-textile hose	3/4"	1	4011160127311	12731
50 m knitted PVC-textile hose	3/4"	1	4011160127328	12732



Safety box



Safety box

IP44



- Reliable impact protection and moisture protection for plugs and connectors
- Suitable for cables with a max. diameter of 9 mm
- Ideally suited to outdoor applications
- Impossible for plugs and connectors to be accidentally disconnected
- Short circuits avoided thanks to the splash-proof container
- Sturdy and impact-resistant material for a long lifespan even with high levels of stress
- In an easily visible red safety colour: perfect for use in the garden
- With practical suspension hook for easy storage
- Reliable internal strain relief with grid lock: can be adapted to the size of the plugs and connectors
- **IPX4**: splash-proof

Version

Safety box for shock-proof plug connections

PU

1

EAN

4011160487071

Art. no.

48707



Plug stakes

Technical data

- Connection 230 V/16 A
- Tested in accordance with DIN EN 50525-2, EN 60730, DIN VDE 0620-2-1
- **IP44**: protected against foreign bodies and splash-proof

Plug stake socket outlet

IP44



- Weather-resistant, shatterproof special plastic
- With shock-proof socket outlets, splash-proof 
- 2 m heavy-duty rubber cable H07RN-F **3G1.5**
- Tested in accordance with DIN EN 50525-2, DIN VDE 0620-2-1
- **IP44**: protected against foreign bodies and splash-proof

Version	PU	EAN	Art. no.
2x shock-proof socket outlets	10	4011160606809	60680
4x shock-proof socket outlets	1	4011160606847	60684



Plug stake socket outlet with timer

IP44



- Weather-resistant, shatterproof special plastic
- With shock-proof socket outlets, splash-proof 
- 2 m heavy-duty rubber cable H07RN-F 3G1.5
- Timer for the convenient control of connected devices
- Perfect for garden or pond lighting
- Tested in accordance with DIN EN 50525-2, EN 60730, DIN VDE 0620-2-1
- **IP44**: protected against foreign bodies and splash-proof

Version	PU	EAN	Art. no.
2x shock-proof socket outlets	10	4011160606854	60685



Ice-stop heating cables

IP44



- Frost-protection heating cable with in-built thermostat
- Provides protection against issues such as frozen water in pipes during the winter months
- Also suitable for overwintering plants
- Ready for installation, with 2 m unheated power cord H05RN-F 3G1.0 and shock-proof plug
- No need for any external temperature monitoring systems or accessories
- Specific output: 15 W/m
- Max. operating temperature: 70°C
- Switches on automatically at +3°C and off again at +10°C (measured at the thermostat at the end of the cable)
- Connection: 230 V/50-60 Hz
- **IP44:** protected against foreign bodies and splash-proof

Overall length	Length of the heated cable	PU	EAN	Art. no.
4 m	2 m	1	4011160670107	67010
10 m	8 m	1	4011160670114	67011
14 m	12 m	1	4011160670121	67012
20 m	18 m	1	4011160670138	67013



LED spotlight 20+3 with remote control

IP20



- 23 bright-white LEDs
- Stable yet handy construction
- The remote control function can be used to operated 3 or all 23 LEDs
- With additional switch on the light
- Option for operation via either built-in battery or rechargeable battery
- Low power consumption and minimal heat build-up
- With magnet, suspension hook and bolt eyelets for attachment
- Dimensions: Ø 13 cm
- Colour temperature: 6400 K, luminous flux: approx. 80 lumen
- Ideal for the home, workshop or office or for other practical hobbies
- For wardrobes, safes, drawers, desks, houseplant lighting etc.
- Operated with 4x AA Mignon batteries (not included)
- **IP20:** for indoor use

Version	PU	EAN	Art. no.
LED spotlight 20+3	1	4011160469602	46960



List of articles

Art no.	EAN	kg	Page	Art no.	EAN	kg	Page
10013	4011160100130	0.10	73	10412	4011160104121	8.10	21
10017	4011160100178	7.30	73	10414	4011160104145	4.50	21
10018	4011160100185	0.20	73, 205	10469	4011160104695	2.10	134
10020	4011160100208	10.50	73	10509	4011160105098	4.70	113
10025	4011160100253	0.20	73	10510	4011160105104	4.00	113
10027	4011160100277	15.00	73	10542	4011160105425	0.10	37
10030	4011160100307	0.40	73	10565	4011160105654	0.30	37
10032	4011160100321	15.30	73	10566	4011160105661	0.30	37
10034	4011160100345	0.40	73	10829	4011160108297	7.40	47
10036	4011160100369	22.30	73	10936	4011160109362	0.01	37
10040	4011160100406	0.70	73	10960	4011160109607	0.02	37
10042	4011160100428	35.25	73	10975	4011160109751	0.50	37
10044	4011160100444	0.20	72	10976	4011160109768	0.40	37
10045	4011160100451	1.00	73	11101	4011160111013	6.80	22
10046	4011160100468	0.30	72	11102	4011160111020	5.80	22
10047	4011160100475	38.70	73	11103	4011160111037	3.50	22
10049	4011160100499	0.20	72	11104	4011160111044	3.30	22
10050	4011160100505	1.50	73, 113	11108	4011160111082	7.30	12
10051	4011160100512	0.40	72	11331	4011160113314	0.50	214
10053	4011160100536	71.00	73	11332	4011160113321	0.50	214
10075	4011160100758	2.50	73, 113	11361	4011160113611	0.30	214
10076	4011160100765	2.80	73, 113	11362	4011160113628	0.30	214
10087	4011160100871	1.40	73, 113	11371	4011160113710	0.80	214
10089	4011160100895	2.60	73, 113	11372	4011160113727	0.80	214
10091	4011160100918	2.00	73, 113	11391	4011160113918	0.40	213
10116	4011160101168	4.80	20	11392	4011160113925	0.40	213
10118	4011160101182	3.70	21	11393	4011160113932	0.40	213
10119	4011160101199	6.60	21	11394	4011160113949	0.40	213
10120	4011160101205	1.70	34	11431	4011160114311	0.50	214
10128	4011160101281	4.80	12	11432	4011160114328	0.50	214
10129	4011160101298	7.50	12	11461	4011160114618	0.60	214
10132	4011160101328	6.50	12	11462	4011160114625	0.60	214
10133	4011160101335	8.60	12	11501	4011160115011	0.40	215
10135	4011160101359	7.60	20	11511	4011160115110	0.50	215
10145	4011160101458	4.60	21	11512	4011160115127	0.50	215
10150	4011160101502	1.90	34	11542	4011160115424	0.18	37
10153	4011160101533	6.60	21	11611	4011160116117	0.40	215
10155	4011160101557	7.40	12	11612	4011160116124	0.40	215
10158	4011160101588	8.10	12	11631	4011160116315	0.60	215
10173	4011160101731	7.30	185	11632	4011160116322	0.60	215
10176	4011160101762	7.30	185	11671	4011160116711	0.90	215
10180	4011160101809	2.10	22	11672	4011160116728	0.90	215
10190	4011160101908	1.50	22	11711	4011160117114	0.20	214
10205	4011160102059	1.60	35	11712	4011160117121	0.20	214
10208	4011160102080	1.60	35	11731	4011160117312	0.10	214
10211	4011160102110	4.30	21	11732	4011160117329	0.10	214
10212	4011160102127	7.70	21	12110	4011160121104	1.00	36
10231	4011160102318	6.50	186	12121	4011160121210	1.20	36
10313	4011160103131	5.70	14	12221	4011160122217	1.60	35
10314	4011160103148	7.80	14	12232	4011160122323	5.00	18
10315	4011160103155	2.30	34	12234	4011160122347	7.40	18
10316	4011160103162	8.00	20	12236	4011160122361	4.40	19
10317	4011160103179	5.10	20	12239	4011160122392	7.80	19
10319	4011160103193	6.90	21	12270	4011160122705	7.00	186
10325	4011160103254	7.10	14	12274	4011160122743	7.00	186
10333	4011160103339	9.40	14	12278	4011160122781	0.40	189
10408	4011160104084	2.10	35	12279	4011160122798	0.40	187
10411	4011160104114	5.00	21	12323	4011160123238	3.80	19

List of articles

Art no.	EAN	kg	Page	Art no.	EAN	kg	Page
12325	4011160123252	6.60	19	18666	4011160186660	0.70	219
12611	4011160126116	6.50	26	18669	4011160186691	0.80	219
12612	4011160126123	6.00	179	18670	4011160186707	0.80	219
12613	4011160126130	6.10	179	18672	4011160186721	0.70	219
12616	4011160126161	9.00	229	19700	4011160197000	8.00	187
12622	4011160126222	3.60	180	19701	4011160197017	7.50	189
12639	4011160126390	3.90	25	20117	4011160201172	0.05	113
12640	4011160126406	5.40	25	20120	4011160201202	2.20	34
12641	4011160126413	4.60	25	20124	4011160201240	9.80	12
12642	4011160126420	5.50	25	20125	4011160201257	9.20	12
12645	4011160126451	6.50	26	20742	4011160207426	12.20	17
12646	4011160126468	6.80	26	20743	4011160207433	13.00	17
12647	4011160126475	7.50	26	20752	4011160207525	11.00	17
12648	4011160126482	9.00	27	20753	4011160207532	12.00	17
12649	4011160126499	12.00	27	22176	4011160221767	7.50	185
12700	4011160127007	5.30	180	22620	4011160226205	2.10	33
12701	4011160127014	7.30	180	22623	4011160226236	8.60	13
12702	4011160127021	0.70	180	22628	4011160226281	5.80	13
12703	4011160127038	1.20	180	22629	4011160226298	7.60	13
12704	4011160127045	2.30	180	22650	4011160226502	2.30	33
12705	4011160127052	0.90	180	22655	4011160226557	7.90	13
12706	4011160127069	1.60	180	22658	4011160226588	8.60	13
12707	4011160127076	2.20	180	22723	4011160227233	9.10	14
12708	4011160127083	3.00	180	22725	4011160227257	7.50	14
12710	4011160127106	0.90	181	22728	4011160227288	2.60	33
12711	4011160127113	1.30	181	22729	4011160227295	8.00	14
12712	4011160127120	1.60	181	23246	4011160232466	7.80	18
12713	4011160127137	2.00	181	23247	4011160232473	11.00	18
12714	4011160127144	0.70	181	23320	4011160233203	11.50	14
12730	4011160127304	12.00	229	23321	4011160233210	12.20	14
12731	4011160127311	8.00	229	23328	4011160233289	8.00	14
12732	4011160127328	16.00	229	23620	4011160236204	2.70	33
13691	4011160136917	0.30	214	23623	4011160236235	7.80	13
13692	4011160136924	0.30	214	23624	4011160236242	11.10	13
13911	4011160139116	0.30	214	23625	4011160236259	9.60	13
13912	4011160139123	0.30	214	23641	4011160236419	9.40	14
14411	4011160144110	0.30	215	23644	4011160236440	9.30	13
16080	4011160160806	1.10	23	23645	4011160236457	9.30	13
16081	4011160160813	1.10	23	23646	4011160236464	9.40	14
16086	4011160160868	1.60	23	23650	4011160236501	3.00	33
16094	4011160160943	1.60	23	23653	4011160236532	12.00	13
16095	4011160160950	2.30	23	23654	4011160236549	9.70	13
16151	4011160161513	2.30	12	23663	4011160236631	11.20	13
16410	4011160164101	1.90	23	23664	4011160236648	9.60	13
16415	4011160164156	2.50	23	23668	4011160236686	10.90	13
16423	4011160164231	3.50	23	23829	4011160238291	9.30	45
16691	4011160166914	0.40	215	23999	4011160239991	12.00	14
16692	4011160166921	0.40	215	24030	4011160240300	0.20	222
18211	4011160182112	0.10	219	24031	4011160240317	0.30	222
18212	4011160182129	0.70	219	24032	4011160240324	0.30	222
18360	4011160183607	0.90	221	24033	4011160240331	0.30	222
18361	4011160183614	0.90	221	24051	4011160240515	0.20	223
18364	4011160183645	0.60	221	24080	4011160240805	0.50	223
18366	4011160183669	0.70	221	24101	4011160241017	0.20	174
18368	4011160183683	0.80	221	24102	4011160241024	0.80	174
18611	4011160186110	0.10	219	24103	4011160241031	0.20	175
18663	4011160186639	0.50	219	24104	4011160241048	0.20	175
18665	4011160186653	0.60	219	24105	4011160241055	0.20	175

List of articles

Art no.	EAN	kg	Page	Art no.	EAN	kg	Page
24106	4011160241062	0.10	175	44060	4011160440601	1.10	166
26000	4011160260001	6.50	32	44061	4011160440618	1.10	166
26020	4011160260209	10.00	32	44100	4011160441004	2.40	166
26100	4011160261008	23.50	30	44109	4011160441097	2.70	166
26101	4011160261015	20.00	31	44150	4011160441509	3.20	166
26102	4011160261022	21.00	31	44159	4011160441592	3.60	166
26103	4011160261039	32.00	31	45011	4011160450112	0.05	79
26104	4011160261046	25.00	30	45012	4011160450129	0.05	79
26105	4011160261053	26.00	31	45030	4011160450303	0.10	79
26200	4011160262005	27.00	30	45031	4011160450310	0.10	79
26201	4011160262012	23.50	31	45032	4011160450327	0.10	79
26202	4011160262029	24.50	31	45034	4011160450341	0.04	79
26203	4011160262036	35.50	31	45035	4011160450358	0.04	79
26204	4011160262043	28.50	30	45037	4011160450372	0.10	216
26205	4011160262050	29.50	31	45039	4011160450396	0.10	79
30040	4011160300400	0.10	205	45041	4011160450419	0.10	79
30041	4011160300417	0.10	205	45042	4011160450426	0.10	79
30042	4011160300424	0.20	205	45080	4011160450808	0.10	81
30043	4011160300431	0.20	205	45081	4011160450815	0.10	204
30044	4011160300448	0.20	205	45084	4011160450846	0.10	204
30045	4011160300455	0.20	205	45085	4011160450853	0.10	81
30050	4011160300509	0.30	205	45089	4011160450891	0.10	204
35011	4011160350115	0.40	215	45100	4011160451003	0.10	80
35012	4011160350122	0.40	215	45209	4011160452093	0.20	46
35211	4011160352119	0.40	216	45221	4011160452215	0.20	46
35212	4011160352126	0.40	216	45222	4011160452222	0.80	47
38601	4011160386015	0.60	57	45223	4011160452239	0.20	46
38603	4011160386039	0.60	57	45224	4011160452246	1.00	188
38604	4011160386046	1.00	47	45230	4011160452307	0.20	46
38605	4011160386053	1.00	57	45305	4011160453052	0.30	44
38606	4011160386060	0.80	57	45416	4011160454165	7.90	45
38609	4011160386091	0.80	57	45458	4011160454585	1.20	44
38616	4011160386169	0.70	57	45460	4011160454608	1.50	44
38618	4011160386183	0.70	199	46010	4011160460104	0.03	166
38619	4011160386190	1.10	199	46011	4011160460111	0.03	166
39011	4011160390111	0.50	216	46012	4011160460128	0.03	166
42211	4011160422119	0.10	162	46101	4011160461019	0.04	166
42303	4011160423031	0.50	163	46151	4011160461514	0.04	166
42305	4011160423055	0.10	194	46201	4011160462016	0.04	166
42311	4011160423116	0.70	162	46252	4011160462528	0.20	171
42411	4011160424113	0.70	162	46260	4011160462603	20.00	171
42412	4011160424120	0.80	163	46261	4011160462610	0.50	171
42413	4011160424137	0.10	163	46265	4011160462658	42.00	171
42417	4011160424175	0.60	162	46266	4011160462665	0.80	171
42422	4011160424229	1.10	162	46268	4011160462689	11.40	171
42435	4011160424359	0.60	163	46269	4011160462696	0.60	171
42803	4011160428036	0.40	160	46271	4011160462719	7.00	169
42804	4011160428043	0.10	159	46272	4011160462726	19.50	169
42808	4011160428081	0.60	158	46273	4011160462733	37.00	169
42810	4011160428104	0.50	157	46323	4011160463235	0.40	153
42820	4011160428203	0.30	158	46324	4011160463242	0.50	153
42822	4011160428227	0.10	160	46325	4011160463259	1.40	153
42823	4011160428234	0.20	161	46326	4011160463266	3.40	153
42824	4011160428241	0.30	159	46333	4011160463334	0.50	153
42825	4011160428258	0.15	161	46334	4011160463341	0.60	153
43803	4011160438035	0.10	164	46335	4011160463358	1.50	153
43804	4011160438042	0.10	164	46340	4011160463402	1.30	153
44059	4011160440595	1.40	166	46341	4011160463419	2.40	153

List of articles

Art no.	EAN	kg	Page	Art no.	EAN	kg	Page
46342	4011160463426	3.50	153	50102	4011160501029	0.10	61
46343	4011160463433	3.50	153	50131	4011160501319	0.20	61
46344	4011160463440	1.54	153	50132	4011160501326	0.20	61
46345	4011160463457	2.36	153	50151	4011160501517	0.30	61
46350	4011160463501	2.90	153	50152	4011160501524	0.30	61
46351	4011160463518	4.50	153	50201	4011160502019	0.30	60
46360	4011160463600	1.00	154	50202	4011160502026	0.30	60
46361	4011160463617	1.20	154	50211	4011160502118	0.40	61
46365	4011160463655	1.00	149	50212	4011160502125	0.40	61
46403	4011160464034	4.30	145	50311	4011160503115	0.50	60
46404	4011160464041	9.50	145	50312	4011160503122	0.50	60
46405	4011160464058	3.50	146	50511	4011160505119	0.50	60
46407	4011160464072	1.20	147	50512	4011160505126	0.60	60
46408	4011160464089	3.40	147	50521	4011160505218	0.70	61
46409	4011160464096	8.00	145	50522	4011160505225	0.70	61
46410	4011160464102	1.20	143	51011	4011160510113	1.30	60
46415	4011160464157	0.60	146	51012	4011160510120	1.30	60
46416	4011160464164	0.80	147	51013	4011160510137	1.10	58
46425	4011160464256	1.30	146	51021	4011160510212	1.20	61
46426	4011160464263	2.10	143	51022	4011160510229	1.20	61
46428	4011160464287	8.20	143	51153	4011160511530	1.90	58
46429	4011160464294	5.40	143	51160	4011160511608	2.00	58
46465	4011160464652	5.70	146	56111	4011160561115	0.50	164
46480	4011160464805	5.60	146	56112	4011160561122	0.50	164
46492	4011160464928	1.80	148	56720	4011160567209	0.60	165
46494	4011160464942	0.70	148	56721	4011160567216	0.60	165
46560	4011160465604	2.30	166	56730	4011160567308	0.80	165
46570	4011160465703	4.00	166	56731	4011160567315	0.80	165
46650	4011160466502	2.60	150	56770	4011160567704	0.40	165
46750	4011160467509	6.10	151	56771	4011160567711	0.40	165
46751	4011160467516	9.30	150	59105	4011160591051	0.90	53
46758	4011160467585	9.30	151	59110	4011160591105	1.50	53
46780	4011160467806	4.80	166	59125	4011160591259	3.50	53
46795	4011160467950	6.50	166	59150	4011160591501	7.00	53
46824	4011160468247	0.30	167	59205	4011160592058	1.20	53
46838	4011160468384	2.70	167	59210	4011160592102	2.00	53
46841	4011160468414	0.10	162	59225	4011160592256	4.70	53
46875	4011160468759	5.50	167	59250	4011160592508	9.40	53
46885	4011160468858	5.20	141	59350	4011160593505	5.80	72
46888	4011160468889	4.50	141	59441	4011160594410	9.10	72
46891	4011160468919	0.10	167	59442	4011160594427	11.00	72
46960	4011160469602	0.20	232	59444	4011160594441	0.20	72
46978	4011160469787	1.40	155	59445	4011160594458	17.50	72
46986	4011160469862	10.30	146	59446	4011160594465	0.70	72
47209	4011160472091	9.30	166	59447	4011160594472	35.00	72
47250	4011160472503	1.00	163	59510	4011160595103	2.50	105
48211	4011160482113	0.10	217	59525	4011160595257	5.70	105
48212	4011160482120	0.10	217	59610	4011160596100	3.50	105
48311	4011160483110	0.05	217	59623	4011160596230	14.40	105
48312	4011160483127	0.05	217	59624	4011160596247	36.20	105
48411	4011160484117	0.05	217	59625	4011160596254	8.00	105
48412	4011160484124	0.05	217	59626	4011160596261	4.80	105
48707	4011160487071	0.10	230	59627	4011160596278	8.40	105
48708	4011160487088	0.30	194	59628	4011160596285	21.30	105
48709	4011160487095	0.20	194	59629	4011160596292	7.70	105
49111	4011160491115	0.05	217	59631	4011160596315	15.20	72
49112	4011160491122	0.05	217	59643	4011160596438	14.40	105
50101	4011160501012	0.10	61	59644	4011160596445	36.20	105

List of articles

Art no.	EAN	kg	Page	Art no.	EAN	kg	Page
59646	4011160596469	4.80	105	60438	4011160604386	0.40	103
59647	4011160596476	8.40	105	60439	4011160604393	0.20	206
59648	4011160596483	21.30	105	60440	4011160604409	0.10	103
59649	4011160596490	7.70	105	60441	4011160604416	0.20	103
60057	4011160600579	0.20	81	60443	4011160604430	0.20	103
60205	4011160602054	0.70	58	60444	4011160604447	0.35	103
60210	4011160602108	1.30	58	60445	4011160604454	1.50	55
60215	4011160602153	1.90	58	60446	4011160604461	2.60	55
60262	4011160602627	2.80	58	60450	4011160604508	0.50	55
60264	4011160602641	4.00	58	60454	4011160604546	1.10	55
60265	4011160602658	6.20	58	60455	4011160604553	0.50	81
60270	4011160602702	2.30	54	60456	4011160604560	1.90	55
60271	4011160602719	1.60	54	60458	4011160604584	3.80	55
60272	4011160602726	0.80	54	60460	4011160604607	0.20	102
60273	4011160602733	3.30	54	60461	4011160604614	0.20	102
60305	4011160603051	0.70	58	60462	4011160604621	0.10	206
60310	4011160603105	1.60	58	60463	4011160604638	0.10	206
60315	4011160603150	2.00	58	60464	4011160604645	0.20	206
60335	4011160603358	2.30	54	60466	4011160604669	0.10	206
60336	4011160603365	2.80	54	60467	4011160604676	1.00	207
60340	4011160603402	8.30	54	60468	4011160604683	0.30	207
60341	4011160603419	10.10	54	60469	4011160604690	0.30	206
60359	4011160603594	4.90	58	60470	4011160604706	0.10	202
60361	4011160603617	2.40	58	60471	4011160604713	0.10	202
60362	4011160603624	2.80	60	60472	4011160604720	0.20	202
60364	4011160603648	4.00	58	60473	4011160604737	0.20	202
60365	4011160603655	6.30	58	60474	4011160604744	0.20	202
60366	4011160603662	2.60	106	60475	4011160604751	0.20	202
60368	4011160603686	6.40	106	60477	4011160604775	2.40	188
60370	4011160603709	4.00	54	60479	4011160604799	5.60	188
60371	4011160603716	1.70	54	60480	4011160604805	0.10	202
60372	4011160603723	0.90	54	60483	4011160604836	0.50	191
60373	4011160603730	3.90	54	60484	4011160604843	0.20	203
60374	4011160603747	5.90	54	60486	4011160604867	0.50	191, 192
60375	4011160603754	5.70	54	60488	4011160604881	0.60	191
60376	4011160603761	0.30	64	60494	4011160604942	0.20	197
60379	4011160603792	0.80	64	60495	4011160604959	0.30	124
60382	4011160603822	1.00	54	60496	4011160604966	1.00	197
60383	4011160603839	2.30	54	60497	4011160604973	1.00	197
60384	4011160603846	6.60	54	60498	4011160604980	0.50	197
60385	4011160603853	6.70	54	60509	4011160605093	3.60	135
60410	4011160604102	0.05	78	60511	4011160605116	3.60	135
60412	4011160604126	0.10	77	60512	4011160605123	10.80	106
60415	4011160604157	0.10	78	60513	4011160605130	36.00	106
60417	4011160604171	0.10	77	60516	4011160605161	4.20	135
60419	4011160604195	0.20	77	60517	4011160605178	3.50	106
60420	4011160604201	0.20	102	60518	4011160605185	11.10	106
60422	4011160604225	0.20	102	60519	4011160605192	14.40	106
60423	4011160604232	0.70	102	60520	4011160605208	0.70	124
60425	4011160604256	0.20	102	60521	4011160605215	22.30	106
60427	4011160604270	0.20	102	60522	4011160605222	0.90	125
60428	4011160604287	0.80	102	60523	4011160605239	4.10	135
60430	4011160604300	0.30	103	60524	4011160605246	0.60	124
60432	4011160604324	0.30	103	60525	4011160605253	1.60	126
60434	4011160604348	0.90	103	60526	4011160605260	1.40	125
60435	4011160604355	0.20	103	60527	4011160605277	1.30	124
60436	4011160604362	0.30	103	60529	4011160605291	2.00	127
60437	4011160604379	0.50	103	60530	4011160605307	0.60	125

List of articles

Art no.	EAN	kg	Page	Art no.	EAN	kg	Page
60531	4011160605314	1.30	125	60806	4011160608063	6.00	122
60533	4011160605338	0.60	91	60807	4011160608070	8.00	123
60548	4011160605482	8.20	106	60809	4011160608094	4.30	121
60549	4011160605499	5.20	106	60812	4011160608124	3.90	121
60550	4011160605505	8.00	118	60813	4011160608131	5.30	122
60551	4011160605512	9.00	118	60814	4011160608148	7.20	123
60552	4011160605529	9.00	118	60832	4011160608322	1.60	126
60554	4011160605543	9.00	118	60833	4011160608339	1.60	126
60555	4011160605550	9.00	118	60854	4011160608544	3.90	121
60556	4011160605567	3.70	121	60869	4011160608698	3.00	201
60557	4011160605574	3.90	121	60874	4011160608742	7.20	89
60558	4011160605581	4.20	122	60931	4011160609312	6.80	133
60560	4011160605604	3.90	122	60932	4011160609329	6.40	133
60561	4011160605611	17.50	119	60933	4011160609336	8.00	133
60562	4011160605628	8.20	105	60934	4011160609343	9.00	133
60563	4011160605635	5.80	105	60935	4011160609350	5.90	201
60564	4011160605642	3.50	105	60960	4011160609602	3.70	131
60565	4011160605659	3.00	105	60961	4011160609619	4.20	131
60566	4011160605666	2.60	106	60962	4011160609626	5.50	131
60568	4011160605680	5.80	106	60963	4011160609633	6.20	131
60570	4011160605703	0.10	102	60971	4011160609718	1.30	97
60572	4011160605727	0.20	102	60972	4011160609725	1.80	97
60575	4011160605758	0.20	102	60973	4011160609732	1.40	97
60576	4011160605765	0.20	102	60974	4011160609749	2.00	97
60578	4011160605789	0.30	103	61010	4011160610103	3.50	106
60579	4011160605796	0.40	103	61015	4011160610158	8.00	106
60581	4011160605819	0.30	103	61017	4011160610172	15.80	106
60590	4011160605901	0.30	202	61025	4011160610257	12.90	106
60592	4011160605925	0.30	202	61026	4011160610264	28.00	106
60595	4011160605956	2.60	106	61027	4011160610271	4.90	106
60600	4011160606007	0.20	81	61028	4011160610288	14.40	106
60612	4011160606120	1.40	59	61031	4011160610318	6.00	106
60671	4011160606717	1.70	59	61034	4011160610349	35.30	106
60672	4011160606724	2.40	59	61038	4011160610387	6.00	106
60673	4011160606731	1.70	59	61039	4011160610394	16.00	107
60680	4011160606809	0.60	231	61040	4011160610400	36.00	107
60684	4011160606847	0.80	231	61041	4011160610417	73.00	107
60685	4011160606854	0.60	231	61070	4011160610707	0.30	94
60703	4011160607035	1.00	126	61080	4011160610806	73.00	107
60704	4011160607042	1.90	126	61081	4011160610813	145.00	107
60730	4011160607301	1.30	95	61093	4011160610936	15.80	106
60731	4011160607318	1.30	94	61097	4011160610974	1.34	106
60732	4011160607325	1.30	95	61205	4011160612053	1.50	106
60733	4011160607332	1.30	94	61305	4011160613050	2.70	106
60734	4011160607349	1.30	95	61306	4011160613067	2.70	106
60735	4011160607356	1.30	94	61335	4011160613357	14.40	106
60736	4011160607363	1.30	95	61336	4011160613364	4.20	106
60737	4011160607370	1.30	94	61360	4011160613609	2.20	106
60738	4011160607387	1.30	95	61364	4011160613647	2.20	106
60739	4011160607394	1.30	94	61370	4011160613708	2.40	188
60740	4011160607400	1.20	91	61391	4011160613913	0.70	191
60751	4011160607516	1.50	95	61412	4011160614125	0.10	77
60753	4011160607530	1.50	95	61420	4011160614200	0.20	101
60764	4011160607646	1.40	95	61422	4011160614224	0.30	101
60766	4011160607660	1.70	95	61423	4011160614231	0.30	101
60768	4011160607684	1.80	95	61424	4011160614248	1.50	101
60781	4011160607813	1.60	95	61425	4011160614255	0.30	101
60804	4011160608049	4.50	122	61427	4011160614279	0.40	101

List of articles

Art no.	EAN	kg	Page	Art no.	EAN	kg	Page
61428	4011160614286	0.30	101	62243	4011160622434	0.10	77
61429	4011160614293	1.70	101	62244	4011160622441	0.10	77
61460	4011160614606	0.20	101	62245	4011160622458	0.10	77
61461	4011160614613	0.30	101	62250	4011160622502	1.60	51
61462	4011160614620	0.30	203	62251	4011160622519	3.80	51
61463	4011160614637	0.30	203	62252	4011160622526	2.40	51
61464	4011160614644	0.10	204	62253	4011160622533	5.40	51
61472	4011160614729	0.80	209	62254	4011160622540	10.70	51
61473	4011160614736	0.10	206	62255	4011160622557	1.60	51
61474	4011160614743	0.10	206	62256	4011160622564	1.60	51
61475	4011160614750	0.40	207	62257	4011160622571	1.60	51
61476	4011160614767	0.40	207	62258	4011160622588	1.60	51
61477	4011160614774	0.10	104	62260	4011160622601	1.40	51
61478	4011160614781	0.20	104	62261	4011160622618	3.10	51
61480	4011160614804	0.30	203	62262	4011160622625	1.90	51
61481	4011160614811	0.20	202	62263	4011160622632	4.20	51
61482	4011160614828	0.60	188	62264	4011160622649	8.00	51
61483	4011160614835	0.60	191	62265	4011160622656	1.40	51
61489	4011160614897	0.60	188	62266	4011160622663	1.40	51
61492	4011160614927	0.20	203	62267	4011160622670	1.40	51
61493	4011160614934	0.20	203	62268	4011160622687	1.40	51
61499	4011160614996	0.10	204	62401	4011160624018	0.10	78
61520	4011160615207	1.40	124	62403	4011160624032	0.10	78
61562	4011160615627	17.50	119	62411	4011160624117	0.10	78
61564	4011160615641	0.30	205	62413	4011160624131	0.10	78
61565	4011160615658	0.20	205	62450	4011160624506	0.10	82
61705	4011160617058	1.40	125	62451	4011160624513	0.10	82
61706	4011160617065	1.40	127	62452	4011160624520	0.10	82
61707	4011160617072	1.40	127	62453	4011160624537	0.10	82
61708	4011160617089	1.40	125	62454	4011160624544	0.10	82
61742	4011160617423	1.30	88	62455	4011160624551	0.20	82
61744	4011160617447	1.80	88	62460	4011160624605	0.10	82
61745	4011160617454	2.10	89	62461	4011160624612	0.10	82
61746	4011160617461	2.50	89	62462	4011160624629	0.20	82
61747	4011160617478	1.30	88	62463	4011160624636	0.20	82
61748	4011160617485	1.50	89, 195	62464	4011160624643	0.30	82
61831	4011160618314	53.00	110	63210	4011160632105	2.00	114
61832	4011160618321	53.00	110	63220	4011160632204	7.50	114
61833	4011160618338	51.00	110	63221	4011160632211	1.90	114
61841	4011160618413	57.00	111	63222	4011160632228	2.00	114
61842	4011160618420	44.00	111	63223	4011160632235	0.10	114
62058	4011160620584	1.00	55	63224	4011160632242	27.00	114
62059	4011160620591	2.40	55	63240	4011160632402	23.00	115
62081	4011160620812	0.10	83	63241	4011160632419	8.90	115
62082	4011160620829	0.10	83	63242	4011160632426	6.60	115
62083	4011160620836	0.10	83	63243	4011160632433	0.20	115
62084	4011160620843	0.04	83	63250	4011160632501	15.00	115
62085	4011160620850	0.04	83	63251	4011160632518	4.80	115
62207	4011160622076	0.20	77	63252	4011160632525	4.40	115
62220	4011160622205	0.10	78	63253	4011160632532	0.20	115
62221	4011160622212	0.10	78	66001	4011160660016	0.90	164
62222	4011160622229	0.10	78	66002	4011160660023	0.90	164
62223	4011160622236	0.10	78	67010	4011160670107	0.50	232
62224	4011160622243	0.10	78	67011	4011160670114	0.90	232
62225	4011160622250	0.10	78	67012	4011160670121	1.10	232
62232	4011160622328	0.10	77	67013	4011160670138	1.50	232
62233	4011160622335	0.10	77	70410	4011160704109	0.50	60
62242	4011160622427	0.10	77	70412	4011160704123	0.50	60

List of articles

Art no.	EAN	kg	Page	Art no.	EAN	kg	Page
70413	4011160704130	1.10	53	90400	4011160904004	0.20	225
70414	4011160704147	1.10	53	90403	4011160904035	0.10	227
70415	4011160704154	1.30	53	90405	4011160904059	0.10	226
70416	4011160704161	2.00	105	90406	4011160904066	0.10	227
70419	4011160704192	3.00	105	90407	4011160904073	0.30	226
70423	4011160704239	0.50	67	90408	4011160904080	0.10	226
70424	4011160704246	0.50	67	90412	4011160904127	0.20	225
70425	4011160704253	0.60	60	90417	4011160904110	0.10	225
70426	4011160704260	0.60	60	90750	4011160907500	3.20	39
70427	4011160704277	0.50	67	360486	4059948002979	0.50	192
70428	4011160704284	0.50	67	360488	4059948002986	0.60	192
70430	4011160704307	0.60	65	660486	4059948002863	0.50	192
70431	4011160704314	3.00	65	660488	4059948002870	0.50	192
70432	4011160704321	3.00	65	760486	4059948003990	0.50	192
70522	4011160705229	0.30	66	761488	4059948004393	0.50	192
70530	4011160705304	0.40	64	860488	4059948000296	0.60	192
70532	4011160705328	0.30	64	SP11101	4011160111013	5.90	22
70552	4011160705526	0.50	64	SP11102	4011160111020	5.80	22
70556	4011160705564	0.40	64	SP11103	4011160111037	3.50	22
70558	4011160705588	0.70	64	SP11104	4011160111044	3.50	22
70631	4011160706318	0.20	66	SP11108	4011160111082	7.30	12
70632	4011160706325	0.20	66				
70641	4011160706417	0.10	66				
70642	4011160706424	0.10	66				
70651	4011160706516	0.20	66				
70652	4011160706523	0.20	66				
70800	4011160708008	0.80	67				
70802	4011160708022	0.80	67				
70832	4011160708329	0.40	67				
70833	4011160708336	0.30	67				
70865	4011160708657	0.30	71				
70866	4011160708664	0.50	71				
70867	4011160708671	0.40	71				
70868	4011160708688	0.70	71				
70869	4011160708695	0.50	113				
70870	4011160708701	0.20	68				
70871	4011160708718	0.30	68				
70873	4011160708732	0.30	69				
70874	4011160708749	0.30	69				
70878	4011160708787	0.30	68				
70899	4011160708992	0.10	205				
70908	4011160709081	0.80	65				
70909	4011160709098	0.50	65				
70910	4011160709104	1.50	64				
70911	4011160709111	0.30	65				
70912	4011160709128	2.30	64				
70913	4011160709135	0.40	65				
70914	4011160709142	0.40	65				
70917	4011160709173	0.50	65				
70918	4011160709180	0.50	65				
70919	4011160709197	0.60	65				
70970	4011160709708	2.50	64				
70977	4011160709777	1.50	64				
71890	4011160718908	1.40	205				
71892	4011160718922	0.30	205				
71895	4011160718953	0.70	205				
87202	4011160872020	0.20	71				
90251	4011160902512	0.20	193				



About us

as - Schwabe GmbH
Merkurstraße 10
72184 Eutingen im Gäu
Germany

Represented by:
Kai Weingärtner
Managing Director

Tel. +49 7457 9 48 53 10
Fax +49 7457 9 48 53 30

d.mueck@as-schwabe.de
www.as-schwabe.de

GTS

The General Terms of Sale
of as - Schwabe GmbH can
be found on our website at
www.as-schwabe.de.





as - Schwabe GmbH

Merkurstraße 10
72184 Eutingen
Germany

Tel. +49 7457 9 48 53 - 10
Fax +49 7457 9 48 53 - 30

d.mueck@as-schwabe.de
www.as-schwabe.de

Your partner for professional lighting and electrical products.