

theben 100 YEARS building automation

1921

Our entire story starts in 1921 with the introduction of the first swivel time switch for staircases – developed by company founder Paul Schwenk to stop lights in staircases being left on all the time. And so Theben's first ever energy-saving product is born.



1928

"Use well the precious time, it flips away so!" In 1928, Paul Schwenk has this quote from Goethe's Faust put up on display in the reception area of the company building at Reinsburgstraße 103 in Stuttgart. 30 employees are based here on five floors, where they produce staircase timers and time switches.



1941

Paul Schwenk is a democrat through and through, and is opposed to the Third Reich. To escape the attentions of the Gestapo in Stuttgart, he looks for a suitable house in the country. He strikes gold in Haigerloch. The former Rose restaurant undergoes an extensive conversion to become the new company headquarters.

1930

The first ELPA automatic time switch with pendulum and mercury tube contact goes into mass production. This marks the beginning of an incredible success story: more than 30 million units are sold, making the ELPA synonymous with staircase light timer switches. A lot of rumours have grown up around this name since then: Are those the initials of his two children, Ellen and Paul? Or is it the abbreviation for "Electrical pendulum automatic device"?



1944

Paul Schwenk falls seriously ill in the autumn of 1943 and passes away in March 1944. The company is managed by engineer W. Schröder and by Wilhelm Weckerle until the founder's son, Paul Eberhard Schwenk, takes charge in April 1945.

1971

1971 provides lots of reasons to celebrate. Firstly, the company can look back proudly on 50 successful years and, secondly, the figures indicate a bright future ahead: an annual turnover of DM 18 million is generated by 360 employees and more than 300,000 time switches are sold in over 50 countries.



1948

Following the currency reform of autumn 1948, Paul Eberhard Schwenk starts rebuilding the company.

The family-run business quickly picks up again. Orders flow in and new faces, such as the future managing director Werner Herl, join the established workforce.



1977

Theben files the patent for its "rotary switching disc", which can be used in analogue time switches and clock thermostats (such as the RAMSES 782) for direct changeover between daily and weekly programs. A patent for the "socket timer" is filed in the same year (more than 30 million units have been sold to date).

1958

The Haus Rose (a converted restaurant) gradually runs out of space and so, in 1958, work starts on a new building on Hohenbergstraße. The component production areas (press, drilling and turning shops) move in first, followed by other production areas once the new building has been extended. By 1970, the entire Theben workforce is finally accommodated under one roof in the large and modern complex on Hohenbergstraße.



1971

The founding of PEZET GmbH (a subsidiary company for die and plastics technology based at the Madertal industrial estate) leads to further expansion of production at the headquarters in Haigerloch. In addition, Theben S.a.r.l. – the company's first international distribution company – is established in France.



1992

It has been almost 30 years since Theben began collaborating on the development of EIB technology (now KNX) and started manufacturing the first BUS-capable time switches and twilight switches. We have been a member of the KNX Association since 1995, working in conjunction with other leading manufacturers to make KNX a world-wide standard.

1983

In 1983, Theben launches its first digital time switch, the TERMINA 1000: 2.2 kg of high technology lies behind the white housing measuring 257 x 128 mm. It quickly becomes a lot smaller: 1984 sees the introduction of the TR 611, which is just 35 mm wide, has only six buttons and is very easy to use.



1999

The new production building is constructed on the Maderal industrial estate in Haigerloch and the whole of production is relocated there from Hohenbergstraße. With a floor space of more than 6000 m², the new facility is responsible for producing time switches, room and clock thermostats, and KNX components. The headquarters now boast a total floor space of over 25,000 m².



1994

Theben launches the LUXOR living comfort control. This system is to be regarded as "The mother of all smart home systems" and offers a whole host of handy and convenient functions: scenes, presence simulation, central OFF. And you don't even need a smartphone! It is programmed by adjusting potentiometers with a screwdriver.



1992

Theben founds a subsidiary in Italy, thereby expanding its influence in Southern Europe for the long term. With its many users, Theben S.R.L. is now a firmly established supplier of premium products on the Italian wholesale electrical market.

2003

Theben launches the LUXOR living comfort control. This system is to be regarded as "The mother of all smart home systems" and offers a whole host of handy and convenient functions: scenes, presence simulation, central OFF. And you don't even need a smartphone! It is programmed by adjusting potentiometers with a screwdriver.





2007

The takeover of High Technology Systems AG, Switzerland (HTS) – the inventors of the presence detector – leads to Theben (Switzerland) AG becoming Theben HTS AG. As a result, Theben expands its expertise in lighting control considerably.

2017

LUXORliving is essentially KNX without ETS. It offers intuitive programming and really easy operation. And because it is based on KNX, it represents a safe and future-proof investment.



2021

This year, we celebrate 100 years of building automation together. The automation of buildings has been part of our company's DNA right from the start. The aim? – To improve comfort for everyone while reducing energy consumption. Our motto is „Energy at the right time“. Both today and tomorrow.



2016

Paul Sebastian Schwenk, the great-grandson of the company's founder takes up his position on the board on 1 September. Together with company partner Nikolas Herl (Head of Finance and Accounting) and board member Thomas Sell he heads up various f3 projects to get Theben „fit for the future“.

2020

The CONEXA 3.0 Performance Smart Meter Gateway is certified by the German Federal Office for Information Security. With CONEXA, Theben is helping to achieve the energy transition and plenty more besides.



"Energy at the
right time."

Paul Schwenk 1921





Dear customers and partners,

Some companies find the process of figuring out their own DNA to be an arduous and lengthy one. For us, it was always obvious:

Theben is synonymous with building automation. We stand for technologies and products that not only help to reduce energy consumption, but are also safe, secure and easy to operate. We stand for "Energy at the right time". That has long been the case: for 100 years to be precise.

While we are on the subject, Theben will be celebrating its 100th anniversary in 2021 – at a time when things are not exactly easy. We would be delighted to mark the occasion together with you, our loyal customers and reliable partners, live and online. All the information you need can be found on our anniversary website at 100.theben.co.uk

We are not only very proud of our history, but also of the strong position we currently hold as an internationally successful family-run business. The hallmarks that have set us apart throughout our entire 100-year history can also be found in this catalogue: innovative premium products that are designed to take building automation and networking to the next level in a highly efficient way. After all, these are all part of our DNA. Today and in the future.

Building Automation since 1921.

Paul Sebastian Schwenk
Chairman of the Board of Management

We're interested in you and your story!

We love nice surprises and would be happy to hear from you – whether you are a friend of Theben already or would like to become one, and whether you already have links with the company or would like to forge some. Alternatively, if you just want to congratulate us on our special anniversary, you can write to us at 100.theben.co.uk

The three most original postcards will be singled out and all of them will be entered into a draw and included in our **100 years of building automation exhibition**.



This is how it works:















Go to 100.theben.co.uk



Upload your text and image.



Send off the card and you're done!

	Areas of expertise	
Building automation and smart home	Smart Home-System LUXORliving	
	KNX house and building automation	
Presence and motion detectors, lighting	Indoor detectors and sensors	
	Outdoor detectors	
	LED spotlights/LED spotlights with motion detectors	
Time and lighting control	Digital time switches	18:00
	Analogue time switches	
	Staircase time switches	
	Dimmers	
	Twilight switches	
	Time relays/hour counters	1234h
	Climate control	Clock thermostats
CO ₂ sensors/room thermostats		
Accessories/appendix	Accessories, Index, Packing units, List of discontinued models, T&Cs, Theben Worldwide	

Diversified Our business areas

100%
MARKE

Eine Initiative
der Elektromarken



Building automation & smart home

Since 1992, more from page 18

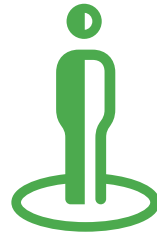

Presence & motion detectors, lighting

Since 2007, more from page 130



Weather station



Actuator technology

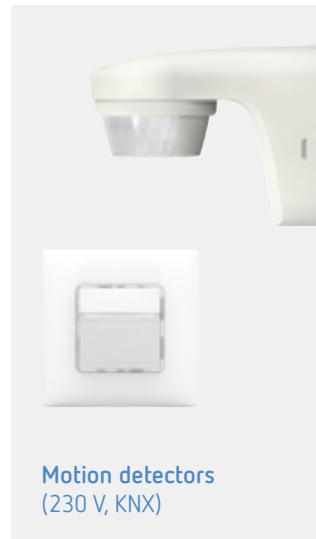

Motion detectors
(230 V, KNX)



Presence detectors
(230 V, KNX, DALI)
Presence sensors
(DALI-2)

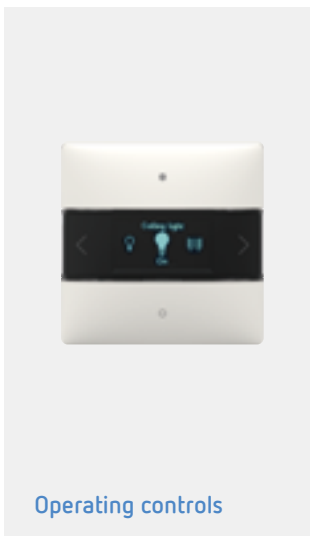

Operating controls



Smart Home

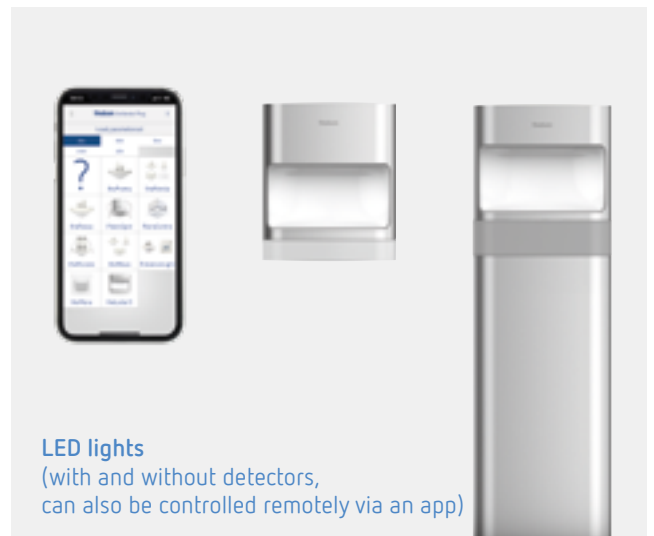

LED lights
(with and without detectors,
can also be controlled remotely via an app)

Theben is a member of:



Time, light & climate control

Since 1921, more from page 242



Smart metering & smart grid

Since 2010, more from page 14

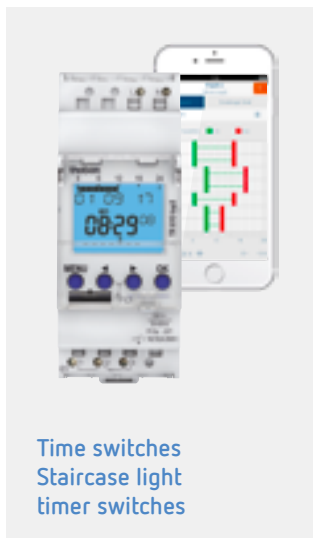

Time switches
Staircase light
timer switches



Twilight switches

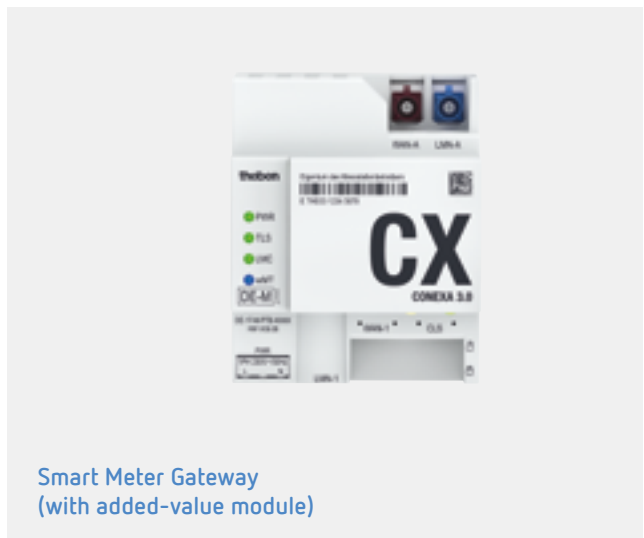

Smart Meter Gateway
(with added-value module)



Dimmers

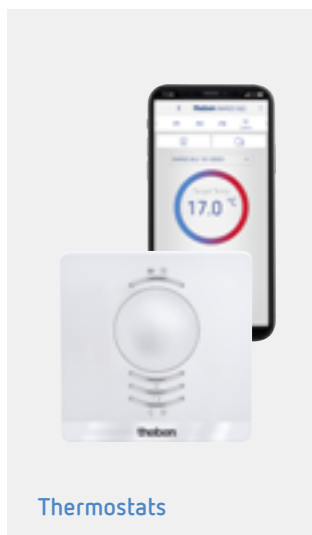

Thermostats

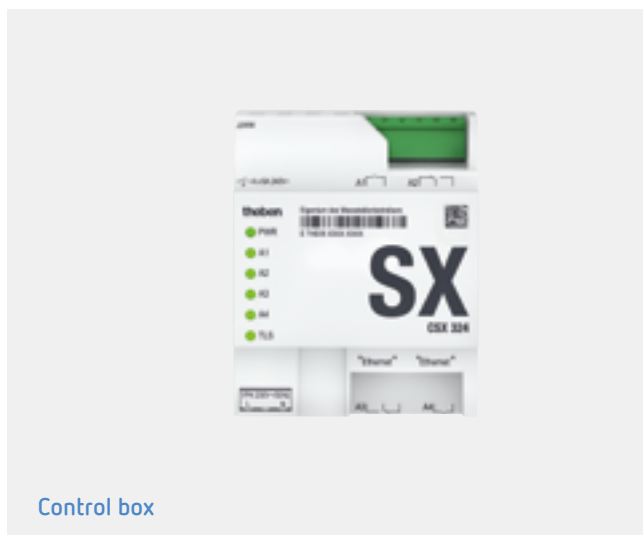

Control box



LEDs are contact killers

Low consumption during operation, but wasteful during switch-on

A simple scenario: In the staircases of a large residential building, the building management replaces the light bulbs with LED retrofit lamps. A specialist measures and verifies the prescribed brightness. The potential for savings is promising: in addition to the more favourable energy consumption, the long service life should reduce maintenance costs.

But suddenly the staircase light timer switches fail. An examination shows scorched or fused contacts: the devices have obviously been overloaded, although the rated output of the installation was reduced significantly.

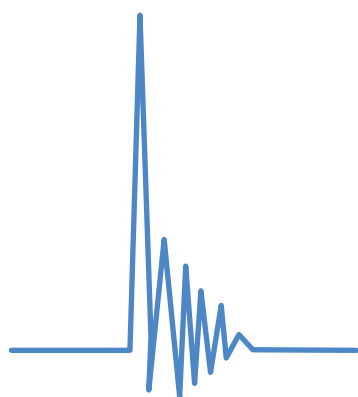

Hard work for the contacts Capacitive inrush loads

How can an LED lamp that only has a few watts of rated output destroy a switching contact that has been designed for several times that? Upon closer inspection, the answer is found in the inrush currents: in light bulbs, the cold spiral coil results in inrush currents that are typically ten times the respective rated current. In LED lamps and energy-saving lamps, the capacitive characteristics result in inrush current pulses in the μs range that can be a 1000 times the rated current or even more. At our VDE-approved laboratory, an inrush current of 19 A was measured for a 1.8 W LED lamp under particularly unfavourable conditions – that's 1706 times the rated output!

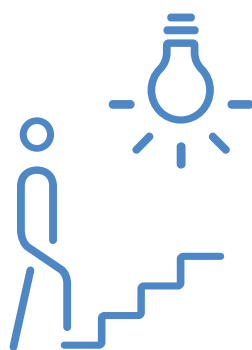

Watch your step! Switch-off pre-warning

At this point, we also wish to draw attention to problems that can affect the switch-off pre-warning (flashing twice or similar according to DIN 18015-2): users will not necessarily notice the flash, as the electronic ballasts or capacitors of the LEDs continue to supply power during this process. Not only that, but repeated switching impairs the service life of the device.

How to switch LEDs

With the right contact at the right time



10 A–10 AX
230 V~

Two contacts for all switching cases: Tungsten pre-contact

High currents require special contacts. Alongside silver tin oxide (AgSnO_2), Theben uses a combination of two contacts closing one after the other: tungsten pre-contacts. The leading contact consists of high-resistance, extremely durable tungsten.

It captures the inrush current and limits it at the same time. As a result, the low-resistance main contact remains unaffected by the peak inrush currents.

Theben uses these relays in its TR 609 top2 S and SELEKTA 175 top2 digital time switches as well as with the theLuxa P performance motion detectors and the theRonda P presence detector.

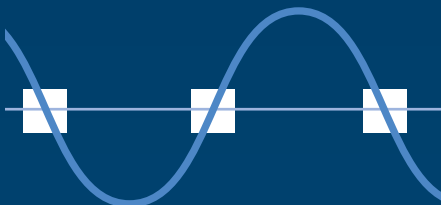

Switching at precisely the right time: Zero-cross switching

Switching devices that are designed for the C load generally cope better with the inrush currents. Theben uses a particularly efficient solution, known as zero-cross switching. It calculates the zero-crossing of the alternating voltage sine curve. At this moment, the inrush current is at its minimum during switching. This protects the relay contact and extends its service life, even at nominally high switching loads. Almost all of the devices from the top2 and top3 series include this feature, as do the theLuxa S motion detectors and many other devices as well.

Environmentally aware and safe switching: Cadmium-free contacts



Cadmium oxide was long thought to have been the ideal contact material for high inrush currents. It is now forbidden according to RoHS guidelines, but there are exceptions for electrical switching contacts. Nevertheless, Theben had already switched to environmentally friendly AgSnO_2 materials at the turn of the millennium. These offer comparably good – in some cases even better – contact and switching properties, such as higher burn-off resistance, increased welding resistance and a significantly reduced tendency towards material migration during direct current operation.



Dimming LEDs?

Not something that should be taken for granted!

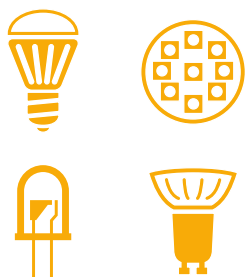

Dimmable or not? Making the right choice is crucial

Not every LED lamp is dimmable. Even with suitable versions, the dimming characteristics differ significantly and depending on the manufacturer. LEDs frequently flicker and cannot be dimmed linearly and consistently because the required electronic ballasts react with great differences to the leading and trailing edge. This is why some manufacturers explicitly allow only one of the methods.



Residual currents are sufficient to cause unwanted continuous light

Another problem is caused by the interference suppression capacitors of the dimmer. Very low residual currents continuously run through them. These are sufficient to supply LED lamps with one to two watts of rated output. They therefore never go out completely.

A similar effect can be caused by long lines positioned in parallel.



Dimmer meets lamp: Not all of them are compatible

For infinitely variable control, not only does the LED lamp have to be dimmable, but the dimmer also has to be LED-compatible. Theben has developed several solutions for this purpose:

- Presets for different LED lamps
- Dimming curves that can be reloaded via ETS



Dimming LEDs!

Theben is a master of that

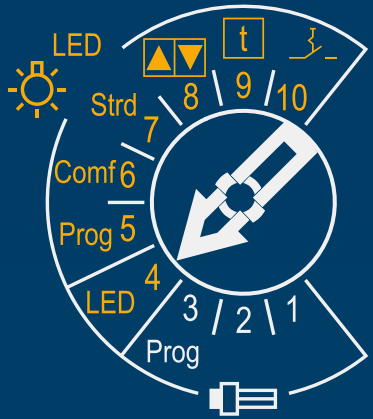

A matter of settings Selecting presets

LED-compatible switching devices from Theben, such as the DIMAX 534 plus universal dimmer, offer additional setting options for perfect adaptation to this technology.

A minimum brightness for LED lamps with low wattages can be set using potentiometers and rotary switches. Even the type of control, leading or trailing edge control, can be preselected. This allows practically all dimmable LED lamps of renowned manufacturers to be controlled reliably.

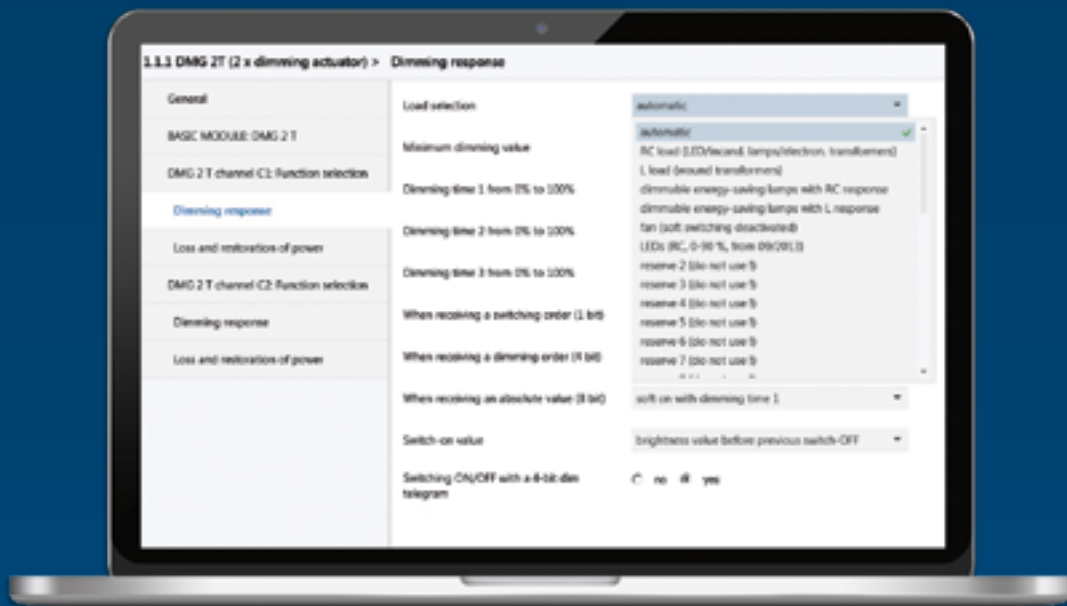

Up to date with KNX Reloading dimming curves

The KNX universal dimmer actuator from Theben goes one step further: the ETS KNX programming software stores various dimming curves, which correct the dimming response appropriately depending on the lamp used, thus ensuring seamless, infinitely variable dimming.

Another advantage of the new dimming actuators is the ability to extend the dimming curves. New dimming curves – e.g. for future lamps – can be imported via ETS. With this update capability, KNX dimming actuators ensure your investments are well protected.



Successfully shaping the energy transition with CONEXA Solutions for municipal utilities & energy providers

The CONEXA 3.0 Performance Smart Meter Gateway from Theben is a secure interface connecting energy suppliers and consumers.

CONEXA ensures that you are able to determine and bill for energy consumption precisely. CONEXA and LUXORliving can be used to create KNX-based smart home solutions that allow for exact assignment and billing.

The plug-on CLS added-value module lets you benefit from innovative value-added services and put completely new business models into effect. And we don't mean at some vague point in the future, but right now..

→ Find out more at www.smart-metering-theben.de



6 good reasons to choose the CONEXA 3.0 Performance Smart Meter Gateway

#01
Certified by the German Federal Office for Information Security according to Common Criteria EAL 4+

#02
Expandable with the CLS added-value module

#03
Multi-client capability for up to 20 meters

#04
Interoperable with all relevant admin systems

#05
Compatible with measuring systems for electricity, gas, water & heat

#06
Can be updated for certified functions

Added value & applications: With CONEXA 3.0 Performance, you just get more!



Die Themenlandkarte des BMWi und BSI bildet die strategische Grundlage zur Digitalisierung der Energiewende. Das Messstellenbetriebs-Gesetz (MsbG) legt in diesem Rahmen die Einsatzbereiche eines Smart Meter Gateways fest.

Die Anwendungen reichen von **Smart Metering/Sub-Metering** und **Smart Grid** über **Smart Mobily** und **Smart Home/Smart Building** bis zu **Smart Services**. Eine enorme Spanne an Einsatzbereichen, die nicht jedes SMGW abdecken kann. CONEXA schon.

At the moment, Theben is the only provider to already have a solution in its portfolio for every category covered by the topic map from the BMWi (German Federal Ministry for Economic Affairs and Energy) and BSI (German Federal Office for Information Security).



Device & development platform: The smart ecosystem for the energy transition

From the very beginning, the CONEXA 3.0 Performance Smart Meter Gateway was developed with the aim of covering ALL the areas included in the BMWi and BSI topic map. At the same time, CONEXA and its added-value module are just one part of Theben's smart technology platform. When combined with the CSX 324 control box and the LUXORliving smart home system, they are able to realise smart mobility, smart grid and smart home/ smart building applications that are really helping to move on the process of digitalising the energy transition successfully.

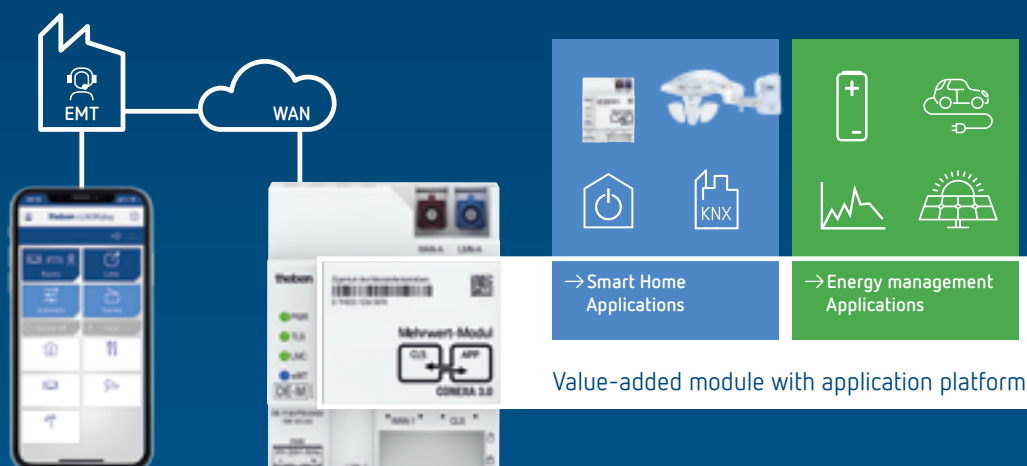



Equipping you for day-to-day tasks

Online and offline training

Our practical training sessions familiarise you with the latest developments, trends, standards and regulations to help you strengthen your competitive position. Basic theory is important – but our seminars focus primarily on putting knowledge into practice to equip you for your day-to-day tasks.

For details of all online and offline training events, visit
www.theben.de/training-courses

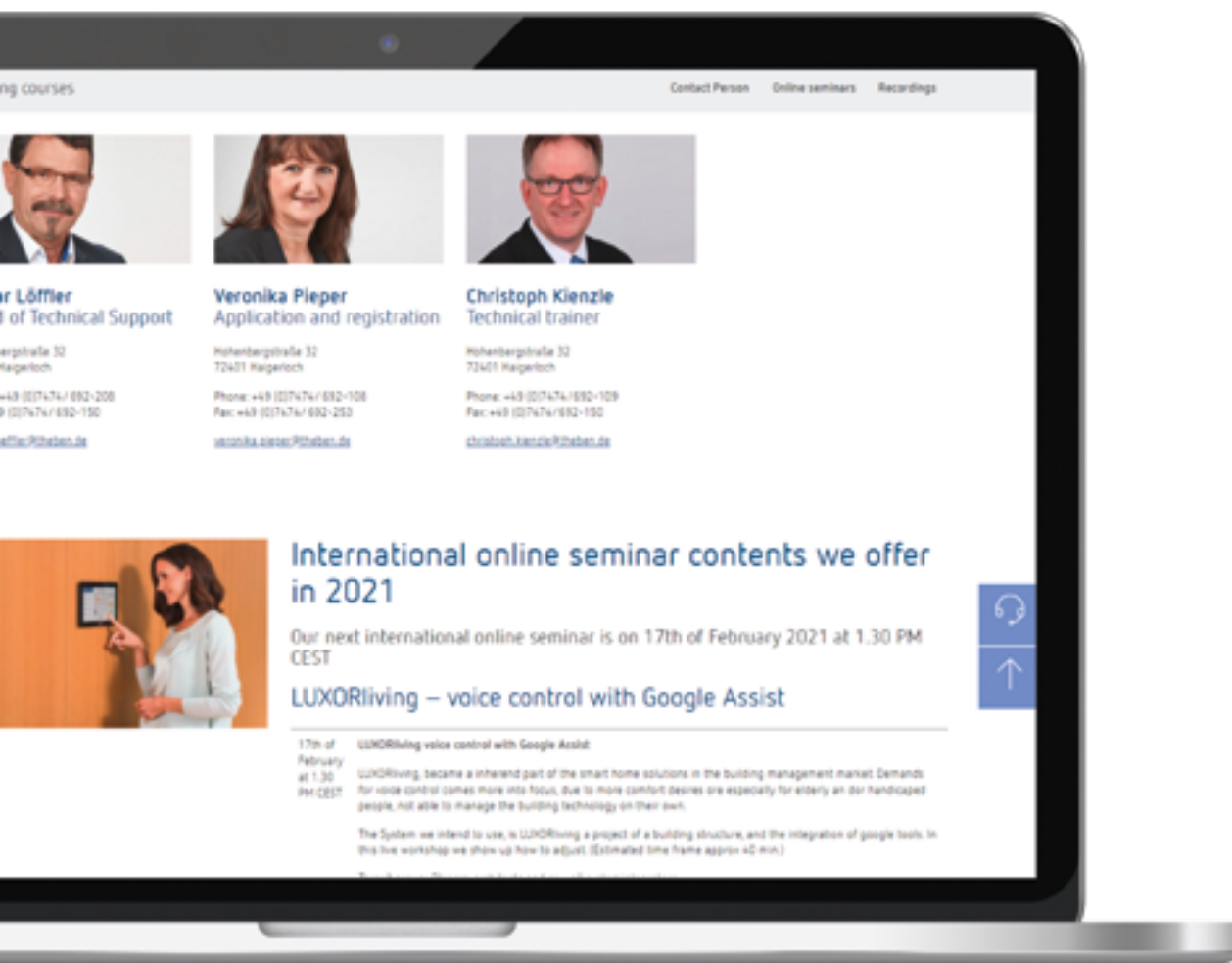

We're always there for you: 24 hours a day, 7 days a week!

[www.theben.de/
training-courses](http://www.theben.de/training-courses)

Can't make that date/time? You've missed the training?
No problem! You can access our training sessions and seminars
at any time by visiting our website at

→ www.theben.de/training-courses or going to
→ youtube.com/thethebenag

Amazingly convenient With simple start-up



Theben apps stand out from the crowd thanks to their security, convenience and incredibly easy operation. The best news of all is that they can be downloaded free of charge from the app stores.

For all the info on our apps, visit www.theben.de/app-en

iONplay

Program and control the iON 108 KNX Bluetooth room controller.

LUXORplay

Control and operate the LUXORliving smart home system with complete ease.

OBELISK top3

Easily program digital time switches.

theSenda Plug

Easily program LED spotlights, and presence and motion detectors.

MAXplus

Control and program the DIMAX 544 plus.

RAMSES BLE

Easily program and control the RAMSES room thermostat.



Our apps are ready and waiting in the stores!

Our apps are ready for you to download from the usual stores:

→ Anroid: Google Play Store

→ iOS: Apple Store



Simply flexible when it comes to set-up.

LUXORliving – intuitive operation

Simply wire, set up, program and you're done. Or retrofit with wireless actuators. The visualisation is generated automatically. With LUXORplug, you can create the project file in an instant. Whether you are carrying out the installation at your office or directly on site, you have everything at your fingertips. And online via the Theben cloud, you have everything to hand with the LUXORplay app – total convenience on a smartphone or tablet.

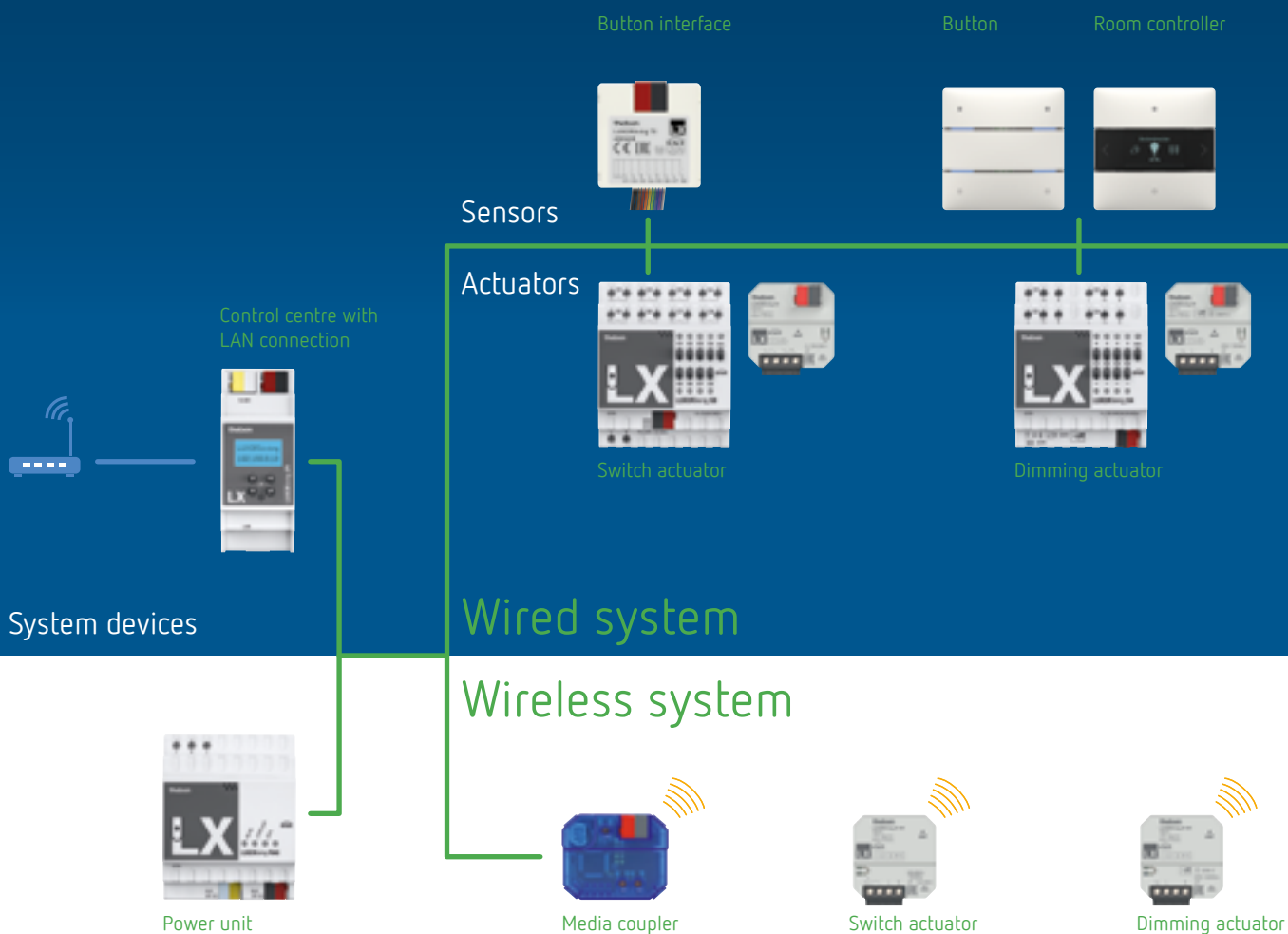

KNX Certified components

LUXORliving uses standard KNX communication, making it a secure investment that is better fit for the future compared to proprietary systems. Updates ensure it is always at the cutting edge and the system is easy to extend if necessary. The show-stopper: LUXORliving has as much KNX as is needed and as little complexity as possible. That's what makes LUXORliving so incredibly simple. For the installer as well as for the user.

Simple start-up

You thought LUXOR was easy to install. LUXORliving is even easier. Easy to assemble, to wire and to set. Job done. No ETS. No licence required. No prior knowledge either. Just go with your intuition – speedy, safe, successful.

BUS Flexible BUS wiring

In conventional set-ups, the functions are preset and fixed through the wiring. This is not the case with LUXORliving. Based on flexible BUS wiring, lights, roller blinds or other applications can be assigned to the buttons of your choice. This gives you leeway to change existing installations and reduces costs, as fewer switches are needed.

Super simple to install.

Old friends – installation with LUXORliving

LUXORliving makes a lot of things easier for everyone. But it keeps some things, such as the installation process, as simple as you've come to expect from Theben and LUXOR.



Weather station



Room thermostat



Binary input

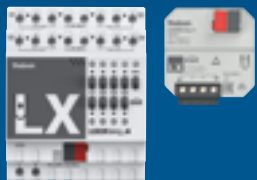

Roller blind actuator /
Blind actuator



Heating actuator



LUXORplug for setting up
the system



LUXORplay for operating
the system



Roller blind actuator /
Blind actuator



Heating actuator



Button
interface



Button module



Free push
button selection

With many smart home systems, the buttons are preset. This is not the case with LUXORliving. With this system, homeowners can choose for themselves whether they use the LUXORliving iON button or any other conventional button in connection with our binary inputs and button interfaces.



Clever
presence simulation

When the occupants are at home, they use LUXORliving. When they're not at home, LUXORliving is of use to them. The clever smart home system makes sure that the lights come on and the blinds go down every evening, leaving the occupants free to enjoy their holiday without having to worry.



Custom
scenarios

Lighting moods and roller blind positions can of course be programmed freely and activated with a command as required. This means that each individual can create the scenes of their choice.

Home, smart home!

LUXORliving smart home system



LUXORliving is the intuitive smart home system from Theben, offering all-round home comfort, whilst avoiding unnecessary waste. LUXORliving controls everything that matters: Switching lights on and off. Dimming. Controlling the heating and the blinds.

And the best thing: LUXORliving is so easy to assemble, install and use that you don't need a system integrator – unless you really want one!



Plug & play:
LUXORplug start-up software and LUXORplay app for operation.

Safety first.

LUXORliving is VDE-certified.











Our home is more than just a roof over our heads. It is somewhere where we want to feel safe and secure. LUXORliving helps to give you this feeling right across the board.

This is also certified by the VDE Institute, which has awarded LUXORliving the seal for "verified information security" after thorough testing.

Safety first.



Description	Type	Page	
LUXORliving Push-buttons			
 LUXORliving Push-buttons	LUXORliving ION2, LUXORliving ION4, LUXORliving ION8	22	
LUXORliving System devices			
 LUXORliving System center	LUXORliving IP1	24	
 LUXORliving Power supply	LUXORliving P640	24	
LUXORliving Sets			
	LUXORliving Sets	LUXORliving set drives	25
		LUXORliving set lighting	25
		LUXORliving set drives and lighting	25
		LUXORliving set drives basic	25
LUXORliving Actuators			
	LUXORliving Switching actuators	LUXORliving S4 / LUXORliving S8 / LUXORliving S16	26
	LUXORliving Dimming actuators	LUXORliving D2 / LUXORliving D4	28
	LUXORliving Blinds actuators	LUXORliving J4 / LUXORliving J8	29
	LUXORliving Flush-mounted actuators	LUXORliving D1 / LUXORliving J1 / LUXORliving S1 / LUXORliving H1 / LUXORliving D1 RF / LUXORliving J1 RF / LUXORliving S1 RF / LUXORliving H1 RF	30
LUXORliving Binary inputs/Push-button interfaces			
	LUXORliving Binary inputs	LUXORliving B6	36
	LUXORliving Push-button interfaces	LUXORliving T2 / LUXORliving T4 / LUXORliving T8	37
LUXORliving Heating control			
	LUXORliving Room thermostat	LUXORliving R718	38
	LUXORliving Heating actuator 24V	LUXORliving H6 24V	39
	LUXORliving Heating actuator	LUXORliving H6	40
LUXORliving Weather station			
	LUXORliving Weather station	LUXORliving M140	41
	LUXORliving Weather sensor	LUXORliving M100	42
	LUXORliving Weather station	LUXORliving M130	42



Description

LUXORliving iON2

- Push-button sensor with 2 buttons and 2 status LEDs with integrated temperature sensor
- For controlling of the functions switching, dimming, blinds, scene in the LUXORliving system
- Multi-colored status LEDs
- Automatic brightness control of the status LEDs depending on the ambient brightness
- Integrated temperature sensor for room temperature control with LUXORliving heating actuators
- Transparent cover for individual labeling in the scope of delivery
- Installation of two ION push-button sensors on standard double socket with accessory 9070822 possible (standard combination distance 71 mm)

LUXORliving iON4

As LUXORliving iON2, but:

- Push-button sensor with 4 buttons and 4 status LEDs with integrated temperature sensor

LUXORliving iON8

- Room controller with integrated room temperature controller
- LC display for displaying functions, icons and values
- 10 freely parameterizable functions
- Display of various icons for the respective functions
- For controlling of the functions switching, dimming, blinds, scene, temperature control in the LUXORliving system
- Automatic brightness control of the display depending on the ambient brightness

- Installation of two ION push-button sensors on standard double socket with accessory 9070822 possible (standard combination distance 71 mm)

Product selection

Type	Article number
LUXORliving iON2	4800412
LUXORliving iON4	4800414
LUXORliving iON8	4800418



Technical data

	LUXORliving iON
Operating voltage	Bus voltage, $\leq 12,5$ mA
Ambient temperature	-5 °C ... $+45$ °C
Type of protection	IP 20
Protection class	III

Scale drawings

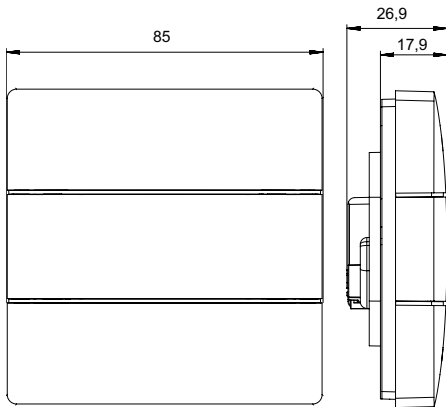

Accessories



2-way mounting plate ION

↳ Art.No.: 9070822

Details page 363

Home and building control

Smart Home system LUXORliving, System center / Power supply

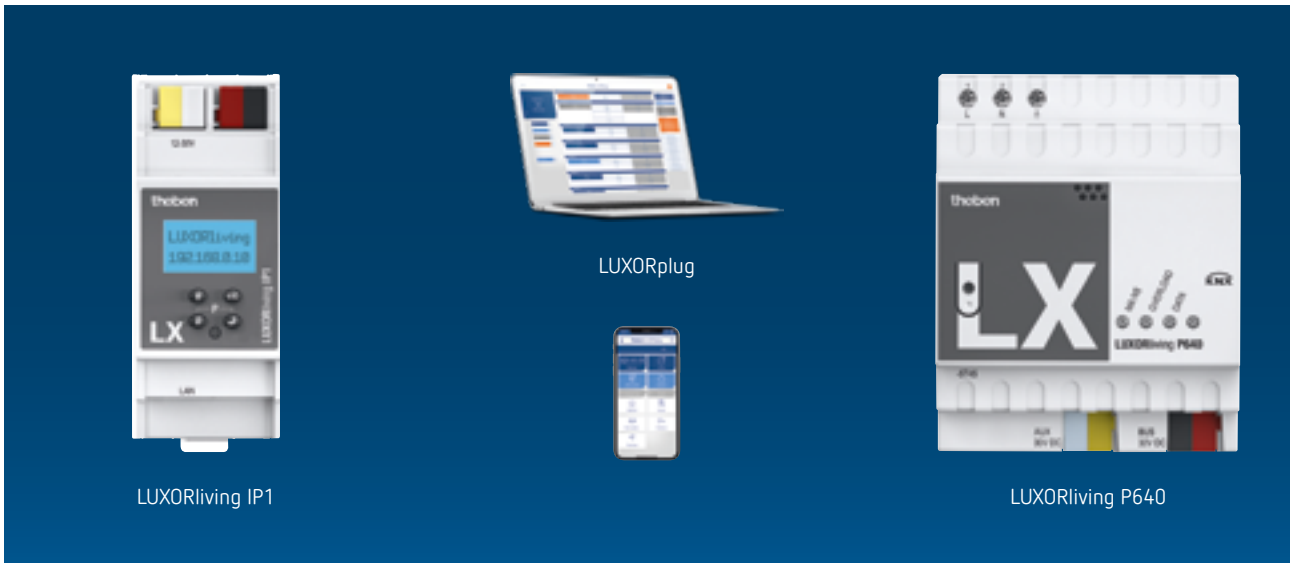

Description

LUXORliving IP1

- System Center LUXORliving
- With Ethernet and bus interface
- For setting-up the LUXORliving system via LUXORplug software
- Storage of project data for visualization via LUXORplay App

LUXORliving P640

- 640 mA supply voltage LUXORliving
- 30 V DC auxiliary supply
- Power-supplying and monitoring of the system voltage

Product selection

Function	Type	Article number
System Center	LUXORliving IP1	4800495
Power supply	LUXORliving P640	4800990

Technische Daten

	LUXORliving IP1	LUXORliving P640
Operating voltage	12-24 V DC	230-240 V AC
Stand-by consumption	< 1,5 W	< 0,8 W
Width	2 modules	4 modules
KNX output	-	1 line with integrated throttle drive
Mains failure bridging time	-	min.100 ms
Type of protection	IP 20	
Protection class	III	II



Description

LUXORliving set drives

- Containing:
 - LUXORliving IP1
 - LUXORliving P640
 - LUXORliving M140
 - LUXORliving J8
 - 2x LUXORliving T4

LUXORliving set lighting

- Containing:
 - LUXORliving IP1
 - LUXORliving P640
 - LUXORliving S8
 - LUXORliving D4
 - 2x LUXORliving T4

LUXORliving set drives and lighting

- Containing:
 - LUXORliving IP1
 - LUXORliving P640
 - LUXORliving M140
 - LUXORliving S8
 - LUXORliving D4
 - LUXORliving J8
 - 4x LUXORliving T4

LUXORliving set drives basic

- Containing:
 - LUXORliving IP1
 - LUXORliving P640
 - LUXORliving J8
 - 4x LUXORliving T4

Product selection

Type	Article number
LUXORliving set drives	4990010
LUXORliving set lighting	4990011
LUXORliving set drives lighting	4990012
LUXORliving set drives basic	4990013

Home and building control

Smart Home system LUXORliving, Switching actuators

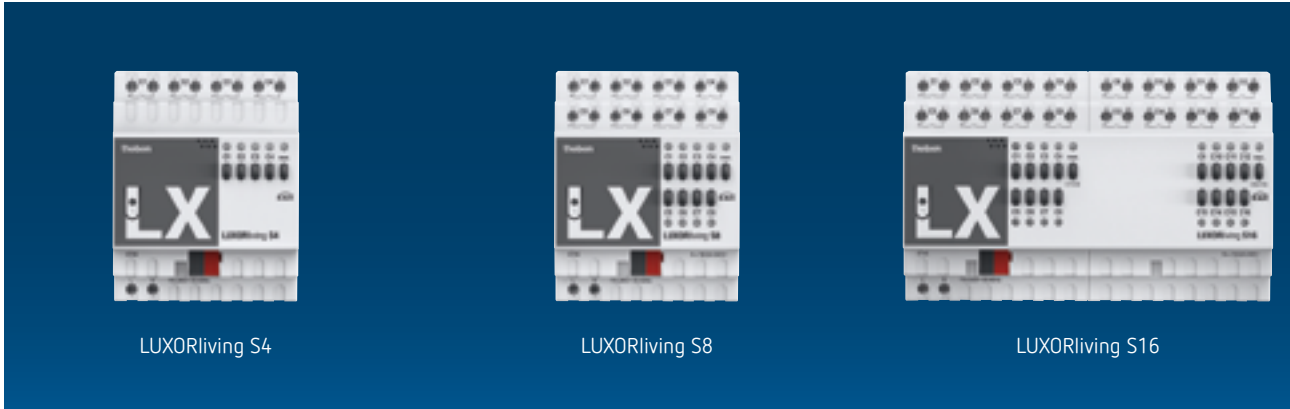

LUXORliving S4

LUXORliving S8

LUXORliving S16

Smart Home system LUXORliving

- LUXORliving is the simple smart home system from Theben, offering all-round home comfort, whilst avoiding unnecessary waste. Switching lights on and off. Dimming. Regulating heating and controlling blinds.
- That's what it's all about. And the best thing: LUXORliving is so easy to assemble, install and use that you don't need to be a specialised fitter – unless you really want to!
- Anyone who is building or renovating should include LUXORliving in their plans. The smart home system makes houses and flats more comfortable and provides a pleasant working atmosphere in offices and doctor's surgeries too. What's more, it creates optimum conditions for you to use your energy-saving potential.

Highlights of LUXORliving at a glance



Simple start-up



Free push button selection



Certified KNX system



Flexible BUS wiring



Safe panic function



Control centre OFF



Individual scenarios



Clever presence simulation

Description Switching actuators

Common functions

- Switching actuator LUXORliving
- LED switching status display for each channel
- Manual operation on device
- Switching functions: On/Off, pulse, On/Off delay, staircase light with warning

LUXORliving S4

- 4-way switching actuator LUXORliving

LUXORliving S8

- 8-way switching actuator LUXORliving

LUXORliving S16

- 16-way switching actuator LUXORliving

Product selection

Number of channels	Type	Article number
4	LUXORliving S4	4800420
8	LUXORliving S8	4800425
16	LUXORliving S16	4800429



Technical data

	LUXORliving S4	LUXORliving S8	LUXORliving S16
Operating voltage	110–240 V AC		
Frequency	50–60 Hz		
Stand-by consumption	< 0,3 W		
Width	4 modules		8 modules
Type of contact	NO contact, 16 A ($\cos \varphi = 1$), 3 A ($\cos \varphi = 0,6$)		
Inrush current	max. 800 A / 200 μ s		
Resistive load	3680 W		
Incandescent lamp load	2000 W		
Fluorescent lamp load (electronic ballast)	1200 W		
Energy saving lamps	300 W		
LED lamp < 2 W (typ.)	55 W		
LED lamp > 2 W (typ.)	600 W		
Unrush current	max. 800 A / 200 μ s		
Operating temperature	–5 °C ... +45 °C		
Type of protection	IP 20		
Protection class	II		

Connection diagrams

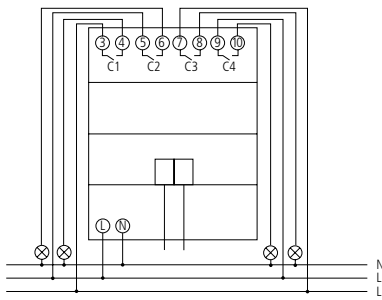

LUXORliving S4

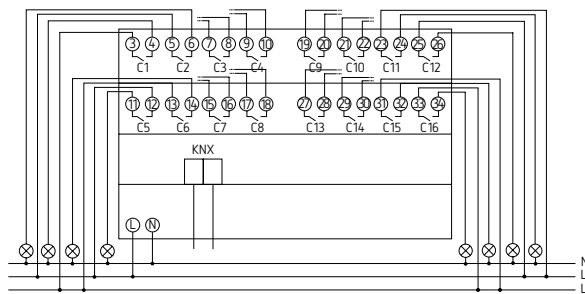

LUXORliving S16

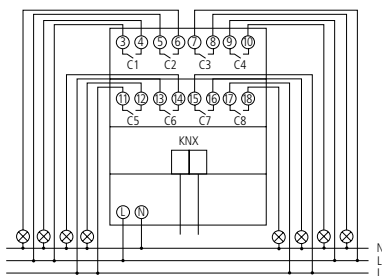

LUXORliving S8

Home and building control

Smart Home system LUXORliving, Dimming actuators



LUXORliving D2



LUXORliving D4

Description

Common functions

- Universal dimmer actuator LUXORliving
- For dimming dimmable LED, incandescent lamps, LV, HV halogen lamps and energy saving lamps
- Also suitable for dimming of dimmable energy-saving lamps

- LED switching status display for each channel

- Manual operation on device

LUXORliving D2

- 2-way universal dimmer actuator LUXORliving

- Dimming output: 400 W per channel, dimming area 0-100%

LUXORliving D4

- 4-way universal dimmer actuator LUXORliving

- Dimming output: 200 W per channel, dimming area 0-100%

Product selection

Number of channels	Switching capacity per channel	Type	Article number
2	400 W	LUXORliving D2	4800470
4	200 W	LUXORliving D4	4800475

Technical data

	LUXORliving D2	LUXORliving D4
Operating voltage	230 V AC	
Stand-by consumption	0,9 W	< 1 W
Width	4 modules	
Lamp types	Incandescent, low-voltage and high-voltage halogen and dimmable energy saving lamps and LED	
Switching capacity dimmable energy saving lamps per channel	400 W	200 W
Switching capacity dimmable 230 V LED (typ.) per channel	Trailing edge (RC-mode): 400 W	
Incandescent/halogen lamp load	400 W	200 W
Type of protection	IP 20	
Protection class	II according to EN 60 669	

Connection diagrams

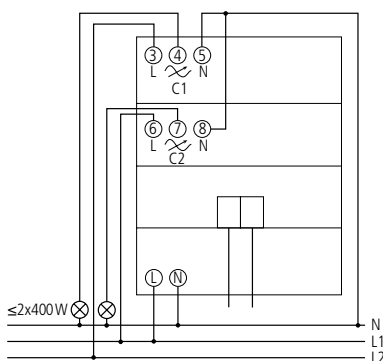

LUXORliving D2

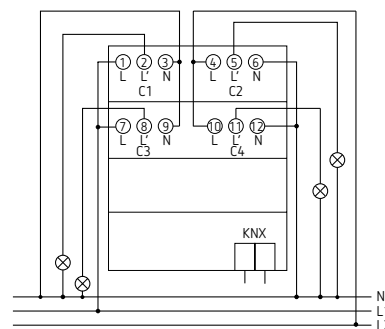

LUXORliving D4

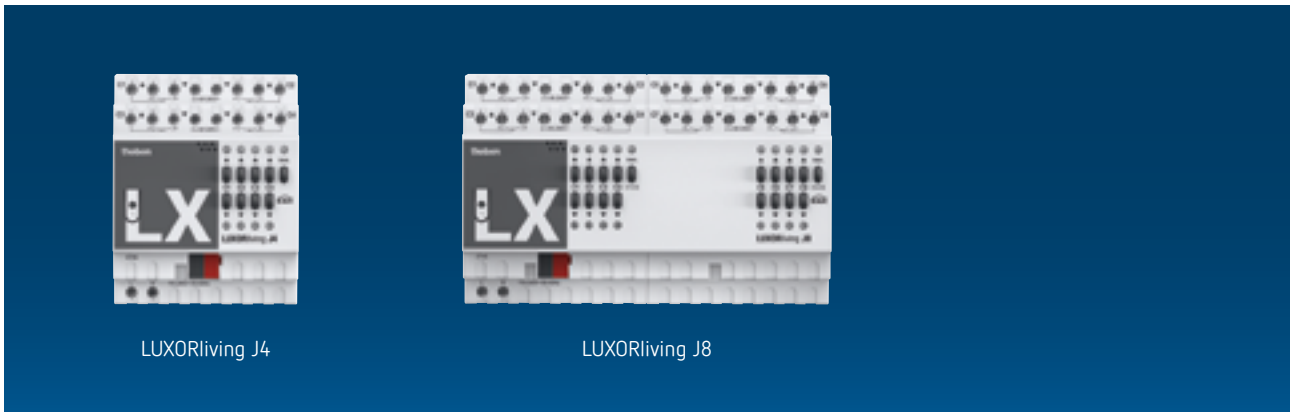

LUXORliving J4

LUXORliving J8

Description

Common functions

- Blind actuator LUXORliving
- For controlling drives for blinds, shutters, sun and vision protection devices
- Manual operation on device

- LED Up and Down switching status display for each channel

LUXORliving J8

- 8-way blind actuator LUXORliving

LUXORliving J4

- 4-way blind actuator LUXORliving

Product selection

Number of channels	Type	Article number
4	LUXORliving J4	4800450
8	LUXORliving J8	4800455

Technical data

	LUXORliving J4	LUXORliving J8
Operating voltage	110–240 V AC	
Stand-by consumption	< 0,3 W	< 0,5 W
Width	4 modules	8 modules
Type of contact	NO contact	
Type of protection	IP 20	
Protection class	II according to EN 60 669	

Connection diagrams

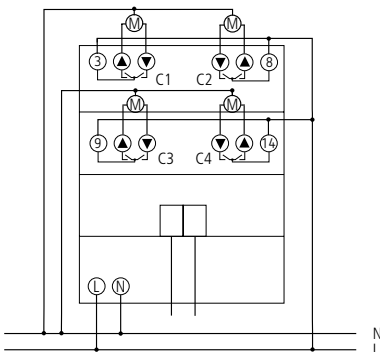

LUXORliving J4

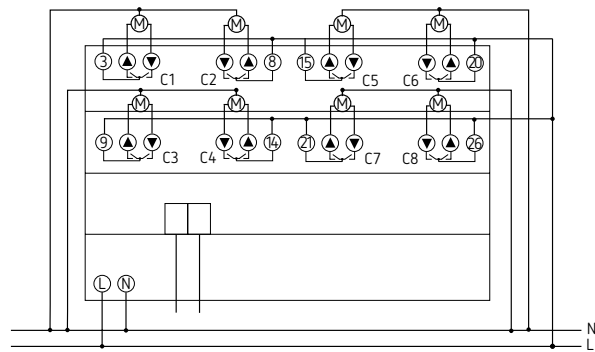

LUXORliving J8

Home and building control

Smart Home system LUXORliving, Flush-mounted actuators



Description

Common functions

- 1-way flush-mounted actuator LUXORliving
- Easy installation due to the compact housing
- 2 binary inputs for floating contacts such as buttons, switches, temperature sensor (I2)
- Integrated temperature monitoring for increased operating safety, e.g. in the event of overload

LUXORliving D1

- 1-way flush-mounted dimming actuator LUXORliving
- Optimised dimming output for dimmable energy-saving lamps, LEDs, incandescent and halogen lamps, and dimmable transformers
- Easy to adapt to different lamps thanks to automatic load detection

- Adjustable dimming curve for precise and flicker-free dimming
- The binary inputs are assigned to the dimming output as standard (function test before programming)

LUXORliving J1

- 1-way flush-mounted blind actuator LUXORliving
- For controlling drives for blinds, roller blinds, sun and vision protection devices, skylights, and ventilation flaps
- The binary inputs are assigned to the output as standard (function test before programming)

LUXORliving S1

- 1-way flush-mounted switching actuator LUXORliving

- 1x NO contact & 1x NC contact with common control
- Adjustable features: NC/NO contact, switching, delayed switching, pulse function
- The binary inputs are assigned to the switch output as standard (function test before programming)

LUXORliving H1

- 1-way flush-mounted heating actuator LUXORliving
- Noiseless control of thermal actuators 230 V AC
- Integrated temperature controller heating / cooling
- Valve protection function

Product selection

Number of channels	Type	Article number
1	LUXORliving D1	4800570
1	LUXORliving J1	4800550
1	LUXORliving S1	4800520
1	LUXORliving H1	4800540

Home and building control

Smart Home system LUXORliving, Flush-mounted actuators



Technical data

	LUXORliving D1	LUXORliving J1	LUXORliving S1	LUXORliving H1
Operating voltage KNX	Bus voltage, ≤ 4 mA			
Energy saving lamps	-		300 W	-
LED lamp < 2 W	Trailing edge (RC-mode): typ. 250 W	-	50 W	-
LED lamp > 2 W (typ.)	Trailing edge (RC-mode): 250 W	-	600 W	-
Inrush current	-		max. 740 A / 200 μ s	-
Switching capacity	-	10 A	16 A	max. 1 A or 4 actuators 230 V AC (ALPHA 5)
Ambient temperature	-5 °C ... +45 °C			
Protection class	II			

Connection examples

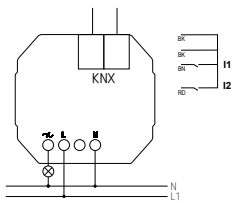

LUXORliving D1

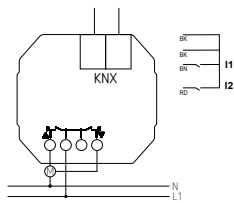

LUXORliving J1

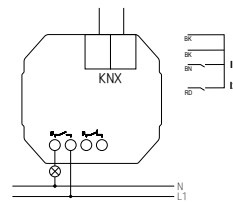

LUXORliving S1

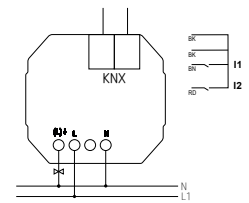

LUXORliving H1

Accessories



Temperature sensor RAMSES
IP 65
↳ Art.No.: 9070459
Details page 361



Temperature sensor
↳ Art.No.: 9070321
Details page 361



Flush-mounted temperature
sensor
↳ Art.No.: 9070469
Details page 361



Actuator ALPHA 5 230 V
for LUXORliving H1
↳ Art.No.: 9070441
Details page 362

Scale drawings

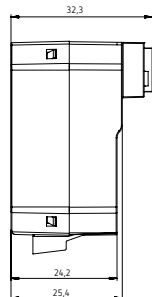
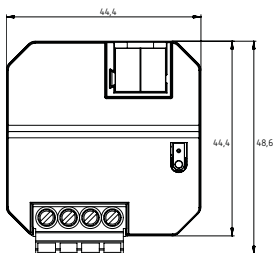

Home and building control

Smart Home system LUXORliving, Flush-mounted actuators



Description

Common functions

- 1-way wireless flush-mounted actuator LUXORliving
- Encrypted wireless communication
- Easy installation due to the compact housing
- 2 binary inputs for floating contacts such as buttons, switches, temperature sensor (I2)
- Integrated temperature monitoring for increased operating safety, e.g. in the event of overload

LUXORliving S1 RF

- 1-way wireless flush-mounted switch actuator
- Adjustable features: NC/NO contact, switching, delayed switching, pulse function

- The binary inputs are assigned to the switch output as standard (function test before programming)

LUXORliving D1 RF

- 1-way wireless flush-mounted dimming actuator
- Optimised dimming output for dimmable energy-saving lamps, LEDs, incandescent and halogen lamps, and dimmable transformers.
- Easy to adapt to different lamps thanks to automatic load detection
- Adjustable dimming curve for precise and flicker-free dimming
- The binary inputs are assigned to the dimming output as standard (function test before programming)

LUXORliving J1 RF

- 1-way wireless flush-mounted blind actuator
- For controlling drives for blinds, roller blinds, sun and vision protection devices, skylights, and ventilation flaps
- Integrated automatic ventilation function
- The binary inputs are assigned to the output as standard (function test before programming)

LUXORliving H1 RF

- 1-way wireless flush-mounted heating actuator LUXORliving
- Noiseless control of thermal actuators 230 V AC
- Integrated temperature controller heating / cooling
- Valve protection function

Product selection

Configuration type	Number of channels	Type	Article number
Switch actuator	1	LUXORliving S1 RF	4800620
Dimming actuator	1	LUXORliving D1 RF	4800670
Blind actuator	1	LUXORliving J1 RF	4800650
Heating actuator	1	LUXORliving H1 RF	4800650

Home and building control

Smart Home system LUXORliving, Flush-mounted actuators



Technical data

	LUXORliving S1 RF	LUXORliving D1 RF	LUXORliving J1 RF	LUXORliving H1 RF
Operating voltage	230–240 V AC	230 V AC	230–240 V AC	230 V AC
Frequency	50–60 Hz			
Switching capacity	10 A	–	5 A	max. 1 A or 4 actuators 230 V AC (ALPHA 5)
Incandescent/halogen lamp load	1800 W	250 W	–	–
LED lamp (typ.)	600 W	Trailing edge (RC-mode): 250 W	–	–
Ambient temperature	–5 °C ... +45 °C			
Protection rating	IP 20			
Protection class	II			

Connection examples

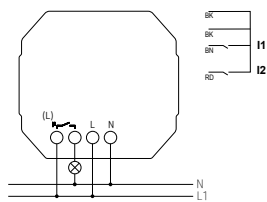

LUXORliving S1 RF

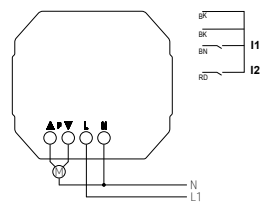

LUXORliving J1 RF

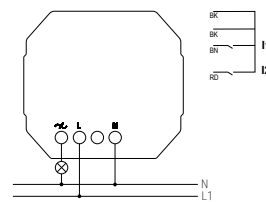

LUXORliving D1 RF

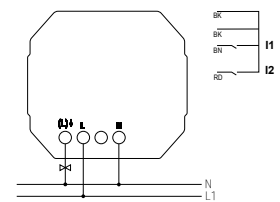

LUXORliving H1 RF

Accessories



Temperature sensor RAMSES
IP 65
↳ Art.No.: 9070459
Details page 361



Temperature sensor
↳ Art.No.: 9070321
Details page 361



Flush-mounted temperature
sensor
↳ Art.No.: 9070469
Details page 361



Actuator ALPHA 5 230 V
for LUXORliving H1 RF
↳ Art.No.: 9070441
Details page 362

Scale drawings

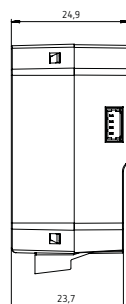
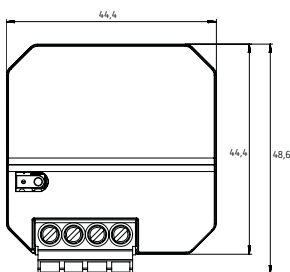

Home and building control

Smart Home system LUXORliving, Binary input



Description

LUXORliving T4 RF

- 4-way flush-mounted wireless push-button interface
- Encrypted wireless communication
- 4 binary inputs for potential-free buttons and signaling contacts
- 1 additional input for temperature sensor
- Free assignment of the functions switching, dimming, blinds, temperature measurement and transmission
- Easy installation due to the compact housing
- Can be used with 4-way push-button module (9070806)

LUXORliving RF1

- Connects LUXORliving RF devices of a radio line with the twisted-pair bus
- Power supply via KNX bus voltage
- Supports long frames for „KNX Secure“ and enables faster download of large applications in parallel
- Ranges of max. 30 m within the building are possible
- Has a repeater function, i.e. received telegrams are sent again to increase the range

Product selection

Type	Article number
LUXORliving T4 RF	4800604
LUXORliving RF1	4800868



Technical data

	LUXORliving T4 RF	LUXORliving RF1
Operating voltage	230–240 V AC	Bus voltage
Frequency	50–60 Hz	–
Stand-by consumption	< 0,4 W	–
Length connecting wires	25 cm	–
Interface extension max.	3 m	–
Ambient temperature	–5 °C ... +45 °C	
Protection class	II	–

Accessories



4-way push-button module
For LUXORliving T4 RF, with integrated temperature sensor
Details page 363

Cover frame
For 4-way push-button module, for common switch ranges
Details page 357

Flush-mounted temperature sensor

↳ Art.No.: 9070469
Details page 361

Connection examples

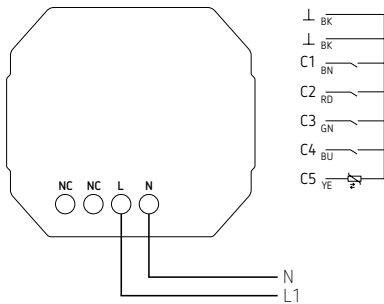

LUXORliving T4 RF

Scale drawings

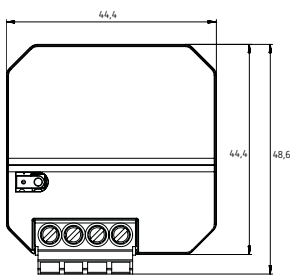

LUXORliving T4 RF

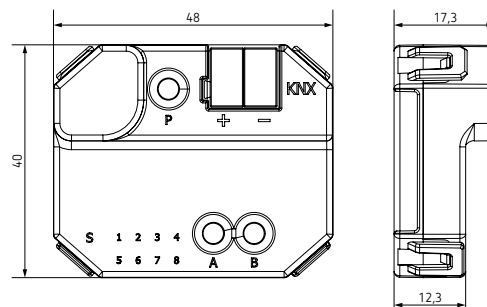
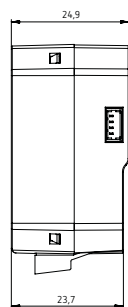

LUXORliving RF1

Home and building control

Smart Home system LUXORliving, Binary input



LUXORliving B6

Description

- 6-way binary input LUXORliving
- 6 floating universal and wide-range voltage inputs (10-240 V AC/DC or internally generated auxiliary voltage of approx. 12 V DC)
- Software functions: Switch/push-button, dimming, blinds
- LED switching status display for each channel
- Manual operation on device

Product selection

Number of channels	Type	Article number
6	LUXORliving B6	4800430

Technical data

LUXORliving B6			
Operating voltage	110–240 V AC	Type of protection	IP 20
Stand-by consumption	< 0,3 W	Protection class	II according to EN 60 730-1
Width	4 modules		



Description

Common functions

- Binary input sensor interface LUXORliving
- Can be installed in flush-mounted sockets with conventional sensors/switches
- Software functions: Switch/push-button, dimming, blinds
- Colour coding of wiring pairs

LUXORliving T2

- 2-way binary input sensor interface
- 4-pole cable connection

LUXORliving T4

- 4-way binary input sensor interface
- 6-pole cable connection

- 2 NTC inputs for detection of the actual temperature

LUXORliving T8

- 8-way binary input sensor interface
- 10-pole cable connection
- 2 NTC inputs for detection of the actual temperature

Product selection

Number of channels	Type	Article number
2	LUXORliving T2	4800402
4	LUXORliving T4	4800404
8	LUXORliving T8	4800408

Technical data

	LUXORliving T2	LUXORliving T4	LUXORliving T8
Interface extension max.		30 m	
Length connecting wires		25 cm	
Contact current		0,5 mA	
Type of protection		IP 20	
Protection class		III	

Scale drawings

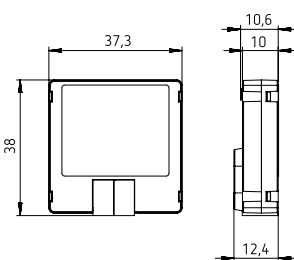

Accessories



Flush-mounted temp. sensor
↳ Art.No.: 9070469
Details page 361



Temperature sensor
↳ Art.No.: 9070321
Details page 361



Temp. sensor RAMSES IP65
↳ Art.Nr.: 9070459
Details siehe Seite 361

Home and building control

Smart Home system LUXORliving, Heating actuator



LUXORliving H6

Description

- 6-way heating actuator LUXORliving
- For controlling 6 thermal actuators
24 V–240 V AC in 2 groups with 3 outputs
and 450 mA each
- Valve protection
- LED switching status display for each
channel
- Manual operation on device

Product selection

Number of channels	Type	Article number
6	LUXORliving H6	4800440

Technical data

LUXORliving H6			
Operating voltage	110–240 V AC	Output	Triac
Stand-by consumption	0,3 W	Type of protection	IP 20
Width	4 modules	Protection class	II according to EN 60 669
Switching output	Not potential-free		

Connection diagrams

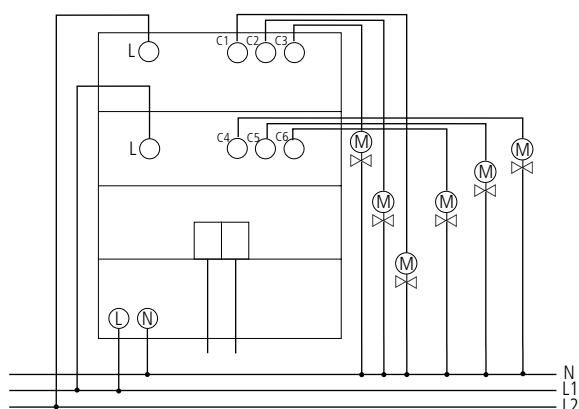

Accessories

Actuator ALPHA 5 230 V

↳ Art.No.: 9070441
Details page 362

Actuator ALPHA 5 24 V

↳ Art.No.: 9070442
Details page 362

Home and building control

Smart Home system LUXORliving, Heating actuator

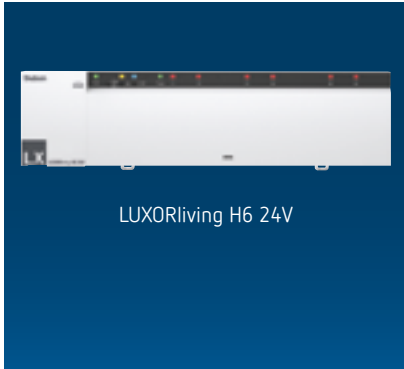

Description

- LUXORliving heating actuator for controlling thermal actuators
- Option of channel-based actuator control: 24 V DC switching or 0–10 V DC continuous
- Integrated relay for demand-based control of heating circuit pump
- No room thermostat required: each channel has a temperature control
- Can be installed directly in the heating circuit distributor
- Screwless terminal technology
- Integrated power supply for max. 12 thermal actuators
- Continuous or switching actuating value can be selected
- Integrated valve protection - Manual operation on device

Product selection

Number of channels	Type	Article number
6	LUXORliving H6 24V	4800441

Technical data

LUXORliving H6 24V	
Operating voltage KNX	Bus voltage, ≤10 mA
Operating voltage	230–240 V AC
Stand-by consumption	< 1 W
Frequency	50–60 Hz
Switching capacity	Valve output: 24 V SELV; 0.4 A peak; 0.12 A permanent or 0-10 V at at least 1250 ohm 24 V output terminal: max. 1.4 A
Switch output	5 A, 240 V AC floating (pump)
Ambient temperature	-5 °C ... +50 °C
Type of protection	IP 20
Protection class	II according to EN 60 730-1

Accessories



Actuator ALPHA 5 24 V
↳ Art.No.: 9070442
Details page 362

Scale drawings

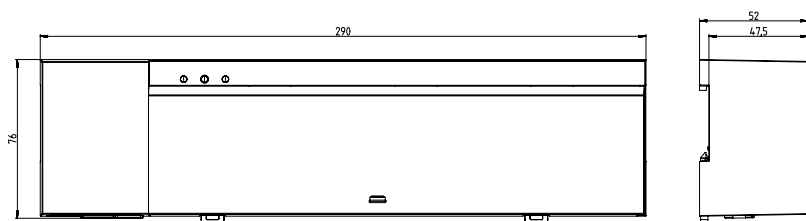

Connection diagrams

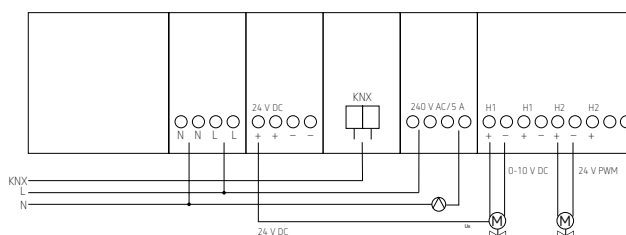

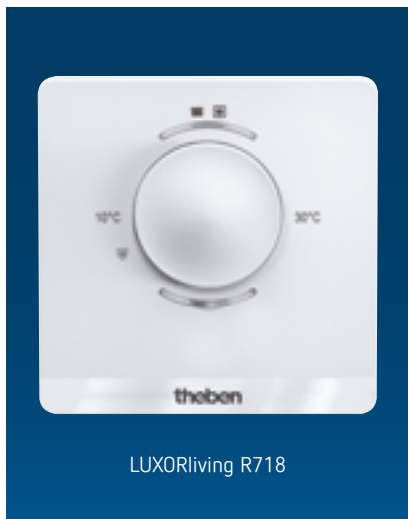

LUXORliving R718

Description

- Individual room thermostat LUXORliving
- Setting range 5 - 30°C
- Applications: heating via radiator or underfloor heating, heating and cooling e.g. radiator or cooling ceiling
- Integrated 4-way binary input sensor interface

Product selection

Type	Article number
LUXORliving R718	4800480

Technical data

LUXORliving R718			
Interface extension max.	5 m	Setting range temperature	+5 °C ... +30 °C
Ambient temperature	+5 °C ... +40 °C	Type of protection	IP 20
Measuring range temperature	-5 °C ... +45 °C	Protection class	III according to EN 60 730-1

Scale drawings

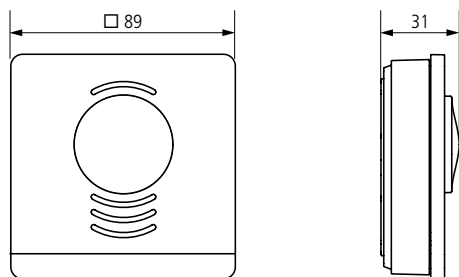

Connection diagrams

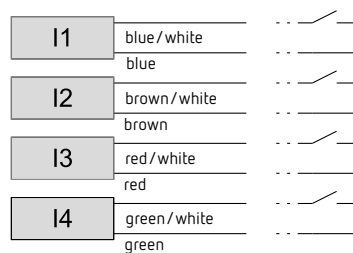

Home and building control

Smart Home system LUXORliving, Weather station



Description

- Self contained outdoor weather station LUXORliving
- For measuring wind, rain, brightness and temperature
- Rain sensor with integrated heating
- For fully automatic blinds and sun protection control
- Measurement and evaluation directly on device
- Sun protection for up to 4 facades via 3 integrated brightness sensors
- Display of weather data e.g. with LUXORliving-App „LUXORplay“

Product selection

Type	Article number
LUXORliving M140	4800490

Technical data

LUXORliving M140			
Operating voltage	110–230 V AC	Measuring range temperature	-30 °C ... +60 °C
Frequency	50–60 Hz	Measuring range wind speed	2–30 m/s
Operating voltage KNX	Bus voltage, ≤10 mA	Ambient temperature	-20 °C ... +55 °C
Stand-by consumption	< 5,5 W	Protection class	II
Measuring range brightness	100000 lx	Type of protection	IP 44

Scale drawings

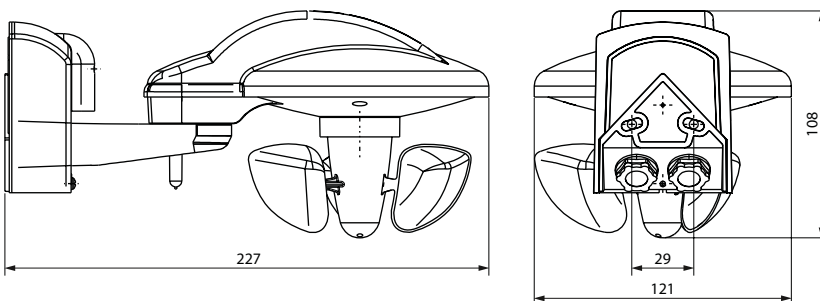

LUXORliving M140

Accessories



Mast fixing S

↳ Art.No: 9070928

Details page 363

Home and building control

Smart Home system LUXORliving, Weather station



Description

LUXORliving M100

- Weather sensor for use with the weather station LUXORliving M130
- Forwarding of the measured values to up to 20 weather stations LUXORliving M130
- For measuring wind, rain, temperature and brightness (3 directions)
- Rain sensor with integrated heating

LUXORliving M130

- Weather station for use with the weather sensor LUXORliving M100
- Receiving and evaluating the measured values from a LUXORliving M100 weather sensor
- Evaluation of wind, rain, temperature and brightness (3 directions)
- For fully automatic blinds and sun protection control
- Sun protection for up to 4 facades
- Display of weather data e.g. with LUXORliving app „LUXORplay“

Product selection

Type	Type	Article numer.
Weather sensor	LUXORliving M100	4800491
Weather station	LUXORliving M130	4800492

Technical data

	LUXORliving M100	LUXORliving M130
Operating voltage	110–230 V AC	–
Frequency	50–60 Hz	–
Operating voltage KNX	–	Bus voltage, < 20 mA
Stand-by consumption	< 5 W	< 0,5 W
Width	–	4 modules
Measuring range brightness	1–100.000 lx	–
Measuring range temperature	–30 °C ... +60 °C	–
Measuring range wind speed	2–30 m/s	–
Ambient temperature	–20 °C ... +55 °C	–
Type of protection	II	II
Protection class	IP 44	IP 20



Scale drawings

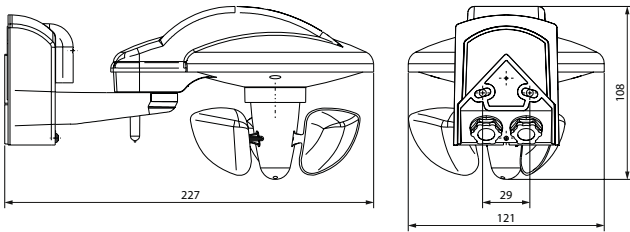

Connection diagrams

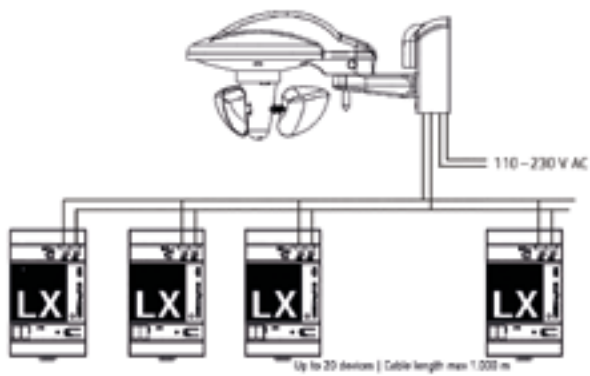

LUXORliving M100

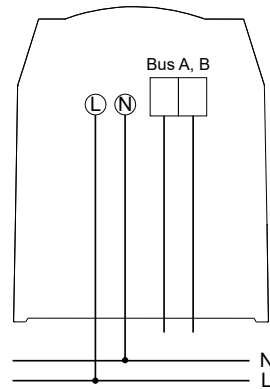

LUXORliving M130

Accessories



Mast fixing S

↳ Art.No: 9070928

Details page 363

Convenient. Stylish.

iON touch sensors and room controllers



Switch on and dim lights, raise and lower blinds, control the room temperature, or save and activate individual scenes. With Theben iON touch sensors and room controllers, a wide range of functions in any KNX-based smart building and in the Theben LUXORliving smart home system can be controlled simply by pressing a button. ID AID has come up with a frameless design that means iON cuts a stylish figure in any room.

- Simple integration thanks to a built-in bus coupling unit
- Integrated sensor for easy temperature measurement
- Reliable status indication via coloured LEDs or LC display
- Customisable button labels

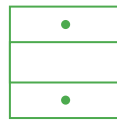

iON 102 KNX
- 1-way touch sensor
(4969232)

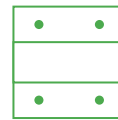

iON 104 KNX
- 2-way touch sensor
(4969234)

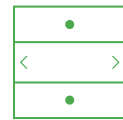

iON 108 KNX
- 20-way room controller
(4969238)

For technical details, see page 52 onwards.

Did you know that our iON touch sensors and room controllers are also available in LUXORliving versions? For more information, see page 22.



A subtle presence – day and night

Multiple colours or one. Bright or dark. The status LEDs of iON 102 and 104 inform you about the current status of the touch sensor. You decide how: in vivid colours or in elegant monochrome. The brightness of the LEDs automatically adjusts to the surrounding brightness. They gleam a little less at night, so no one is disturbed, and a little brighter during the day, so they are clearly visible.

Clearly convenient

iON 102 and 104 can be labelled according to your needs and preferences. You can choose between clear function descriptions, such as "light on", "TV scene" or "blinds up". Or you can design the surface entirely to suit your taste. It's even easier if you download our practical templates from www.theben.de/ion-en



More functions – more convenience

iON 108 room controllers feature a high-quality and extremely durable LC display. So you see clearly what's going on. Select an icon for each of the 10 or 20 functions and assign suitable function names to them. The current status is also displayed. Operating your smart home couldn't be easier.

Speaking of operation: iON 108 KNX can also be easily controlled via Bluetooth using an app. App operation is perfect for meeting rooms or hotel rooms. Guests simply control the functions of the room themselves.



Dimming LEDs precisely Today and in the future



Whether you opt for the FIX series or the MIX series – with KNX universal dimmer actuators from Theben you can steplessly dim LED, halogen and energy-saving lamps without any flickering. The only prerequisite is that the selected lamp is dimmable. In view of the increasing number of connected LED lamps with small wattages, multiple channels provide greater freedom of design.

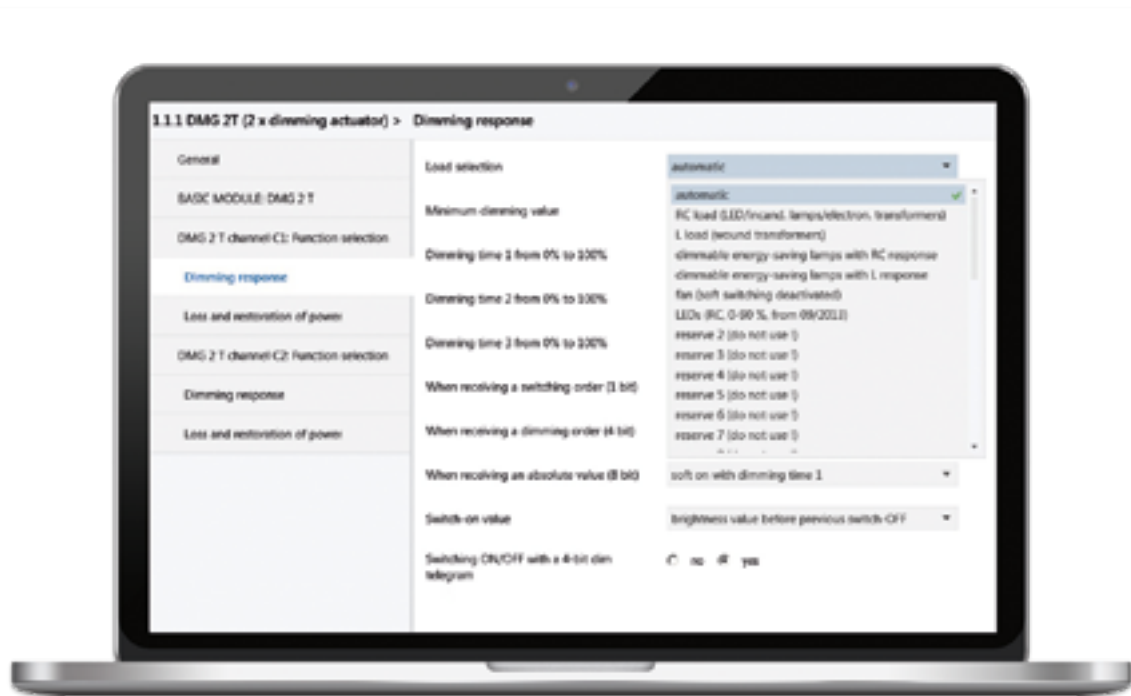

Up to date with KNX Reloading dimming curves

KNX universal dimmer actuators from Theben go one step further: the ETS KNX programming software stores various dimming curves, which correct the dimming response appropriately depending on the lamp used, thus ensuring seamless, infinitely variable dimming. Dimming curves can also be individually adapted to your lamps for a consistent dimming response. Another advantage is the high dimming output with up to 400 LED watts per channel. This output can even be increased to 800 watts by connecting 2 channels in parallel.

Continuous, flicker-free, consistent KNX dimming actuators for all LED wattages



MIX2 range (page 54 onwards)



Flush-mounted actuator range
(page 76 onwards)



FIX1 and FIX2 ranges (page 68 onwards)

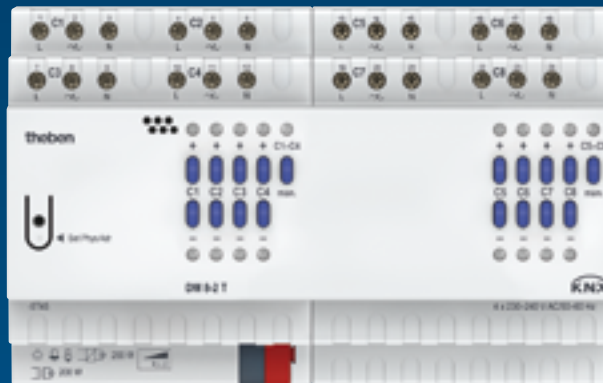

Optimised for small wattages

The times of high wattages are over. Today, the art is in dimming LEDs with small wattages. Theben is on top of this trend, offering dimming actuators with a minimum load of just 2 watts.



Optimised dimming curves

Various dimming curves are stored in the ETS KNX programming software and these correct the dimming response appropriately depending on the lamp used, thus ensuring step-less dimming.



Fast start-up

Buttons (25%, 50%, 75%, and 100%) allow quick function tests to be performed for start-up, even without a bus connection. In the case of the MIX series, the bus module can even be plugged in afterwards.



Versatile scene function

Like the RMG 8 S KNX switching actuator, the DMG 2 T KNX allows you to save different scene functions.

Mix and match

Everything you need for KNX



Basic module (G)

+ maximum 2 extension modules (E)

MIX2 benefits at a glance

1. Removable bus coupling unit

The installer fits the basic module (G). Meanwhile, the bus coupling unit is configured by the system integrator – from the comfort and convenience of the office. Then, just before start-up, the module is simply plugged in – job done! This is a cost-effective approach because you do not necessarily need an installer with an expert knowledge of bus technology to be present on site for the installation and wiring.

2. Inexpensive extension devices

As only the basic module is fitted with a bus coupling unit, the costs of the extension devices (E) are up to a third lower because fewer system devices are required. This really pays off. Especially in property construction. Just do the maths and you'll see for yourself!

3. Flexible expandability

Controlling and dimming lighting, adjusting the heating and indoor climate and ensuring protection from the sun are not just tasks that the KNX MIX2 range can handle – they are what it was made for! With MIX2, you can create a solution that is individually tailored to each room and its specific needs. Only Theben offers this flexibility.

4. Clearly arranged application

The configuration menus in ETS are not only identically structured for all actuators, but also very clearly and intuitively arranged. You can select the actuators you want via drop-down menus according to your project and requirements. And if you need an extension module with a different range of functions, you can even select them later on. Only Theben offers this.



MIX2 actuators – the video
Intelligent, flexible, expandable



Our MIX2 video explains the many advantages of the MIX2 series in an easily understandable way.



www.youtube.com/TheThebenAG

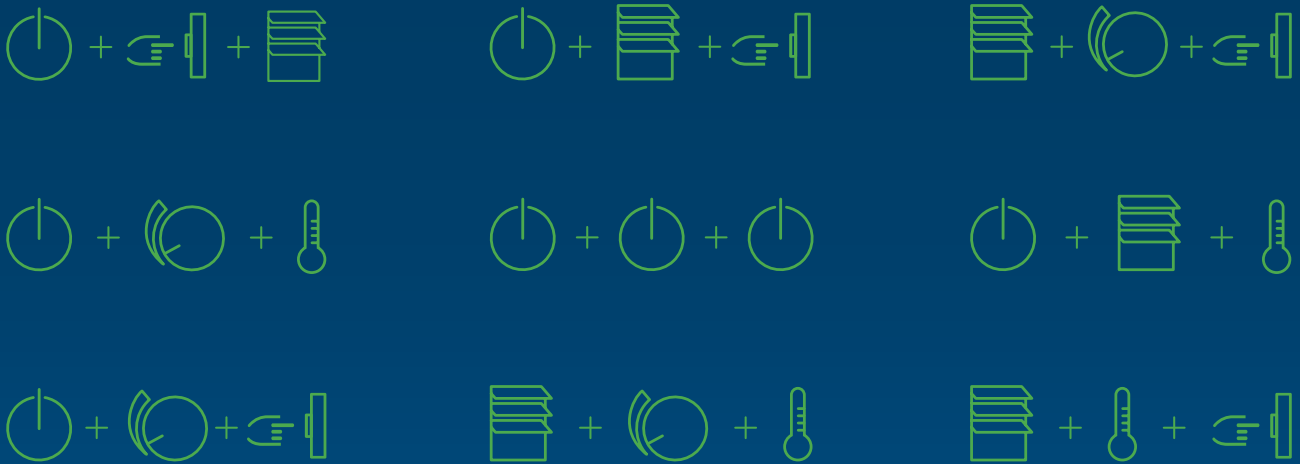

Mixing it up – with 129 functions and up to 729 combinations



Switching

However you want it

Switch things on/off with or without a delay or receive a warning before the staircase light goes out, e.g. using the 4-way C load switch actuators, which offer you new levels of freedom on up to 12 channels. They feature current detection and are designed for higher lamp loads.

Switch actuators

MIX2 RMG 4 U KNX
MIX2 RME 4 U KNX
MIX2 RMG 4 I KNX
MIX2 RME 4 I KNX
MIX2 RMG 8 S KNX
MIX2 RME 8 S KNX



Dimming

But done right

Theben's universal dimming actuators have already proven themselves on the market. Compatible with all currently available LED lamps, they are flicker-free and ensure a beautifully even increase in brightness. And they have been enthusiastically received without exception. They are considered to be among the best dimming actuators of all.

Dimming actuators

MIX2 DMG 2 T KNX
MIX2 DME 2 T KNX



Blinds

Flexible control

The switch/blind actuators allow you complete flexibility when it comes to switching and control. Choose between 4 to 8 or 12 blinds and 24 switching channels. Or mix and match. You can do all this with just three modules. This approach gives you more freedom in how you use the channels – particularly, as you can assign the modules subsequently however you like.

Switch/blind actuators

MIX2 RMG 8 T KNX
MIX2 RME 8 T KNX

Blind actuators

MIX2 JMG 4 T KNX
MIX2 JME 4 T KNX
MIX2 JMG 4 T 24V KNX
MIX2 JME 4 T 24V KNX



Heating

The key to affordable heating

Theben's heating actuators allow you to detect the temperature in individual rooms using affordable temperature sensors. Temperature control takes place in the actuator itself and the target temperature can, for example, be set centrally using the theSer-va KNX visualisation solution.

Heating actuators

MIX2 HMG 6 T KNX
MIX2 HME 6 T KNX

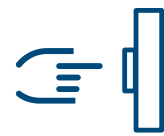

Binary inputs

Universal application

Theben binary inputs cover the full range of contacts and voltages – whether floating contacts, or 24 V or 230 V. Each of the binary inputs offers six of them. That means more flexibility and greater security of investment. Not only that, but each channel can be tested manually during maintenance or service.

Binary inputs

MIX2 BMG 6 T KNX
MIX2 BME 6 T KNX

KNX – one technology offering unlimited options



KNX turns buildings into something more – whether used in universities, schools, other administrative and office buildings, nursing homes and hospitals, museums, hotels or private homes. The advantage of a KNX installation is its versatility. With KNX, all building functions can be linked, programmed, and controlled, from the HVAC systems, lighting and shading right through to the alarm, safety and information systems.

All these functions can be controlled automatically via intelligent sensors, manually at the control units inside the rooms or centrally via a visualisation system – either at home or while out and about using your smartphone or tablet.



Theben, KNX and the KNX Association The fieldbus and the history behind it

KNX stands for “Konnex” or “Connectivity” and is a fieldbus for building automation. KNX came about as the result of a merger between the European organisations EIBA, EHSA, and BCI, who were all seeking a common standard for the fieldbuses in existence at the time. Today, KNX is the global standard for house and building automation (ISO/IEC 14543). Worldwide, there are more than 90,000 trained KNX partners in 190 countries. The rules and specifications for the KNX technology are defined and regulated by the KNX Association, which now has a global membership of more than 495 companies. KNX thus stands for high security of investment and technology that is extremely future-proof.













Theben was one of the very first companies to join the association and, as a member of the Executive Committee, actively influences the further development of KNX technology. In addition, we have been a member of the KNX Technology Committee since 2015. In 2019, Theben was the first manufacturer to introduce KNX wireless actuators according to the Data Secure standard.

Theben – a competent partner for everything to do with KNX.

For more information, visit www.knx.org





Description	Type	Page
Push-buttons		
 Push-buttons	iON 102 KNX,iON 104 KNX,iON 108 KNX	52
Switching actuators		
 Switching actuators	RMG 4 U KNX/RME 4 U KNX/ RM 4 U KNX/RMG 8 S KNX/RME 8 S KNX/RM 8 S KNX/ RM 16 S KNX/RMG 4 I KNX/RME 4 I KNX/RM 4 I KNX/RM 8 I KNX/RM 4 H KNX/ RM 8 H KNX/RMG 8 T KNX/RME 8 T KNX/RM 8 T KNX/RM 16 T KNX	54
Blinds actuators		
 Blinds actuators	JMG 4 T KNX/JME 4 T KNX/ JM 4 T KNX/ JM 8 T KNX/ JMG 4 T 24V KNX/ JME 4 T 24V KNX/JM 4 T 24V KNX/JM 8 T 24V KNX	64
Dimming actuators/DALI-Gateways		
 Universal dimming actuators	DMG 2 T KNX/DME 2 T KNX/DMB 1 T KNX/DM 2 T KNX/DM 4 T KNX/DM 4-2 T KNX/ DM 8-2 T KNX	68
Control units	SMG 2 S KNX/SME 2 S KNX	72
DALI-Gateways	DALI-Gateway KNX plus/ DALI-Gateway S64 KNX/DALI-Gateway S64 KNX	74
Flush-mounted actuators		
 Switching actuators / Blinds actuators / Universal dimming actuators	SU 1 KNX/JU 1 KNX/DU 1 KNX/HU 1 KNX/SU 1 RF KNX/JU 1 Rf KNX/DU 1 RF KNX/ HU 1 RF KNX/Media coupler TP-RF KNX/TU 4 RF KNX	76
Binary inputs		
 Binary inputs	BMG 6 T KNX/BME 6 T KNX/BM 6 T KNX/BM 12 T KNX	82
Binary inputs for flush-mounted sockets	TA 2 S KNX/TA 4 S KNX/TA 6 S KNX/TA 8 S KNX	84
Presence and motion detectors		
 Presence detectors / Multi-sensor	thePrema KNX/ thePrema P360 KNX Multi AP/ PlanoSpot KNX / theRonda P KNX/ theRonda S KNX/ thePassa KNX/ PresenceLight 360 KNX/ PresenceLight 180 KNX	86
Motion detectors	theLuxa P KNX	102
System devices		
 Interface and line coupler	IPsecure Interface KNX/IPsecure Router KNX/Interface USB KNX/Line coupler S KNX	104
Supply voltage	PS 640 mA/320 mA/160 mA	106
HVAC controller		
 Multifunction display and room thermostats	VARIA 826 S KNX/RAMSES 718 P KNX/RAMSES 718 S KNX	108
Heating actuators	HMG 6 T KNX/HME 6 T KNX/HM 6 T KNX/HM 12 T KNX/HMT 6 S KNX/HMT 12 S KNX	112
Motor-driven actuators	CHEOPS control KNX/CHEOPS drive KNX	115
 CO ₂ room air sensor	AMUN 716 S KNX	116
Room thermostat Fan-Coil and Fan-Coil actuator	RAMSES 713 FC KNX/FCA 1 KNX /FCA 2 KNX	117
KNX-OpenTherm-Gateway	KNX-OT-Box S	109
Digital time switches		
 8 channel time switch with yearly and astro program	TR 648 top2 RC KNX/TR 648 top2 RC-DCF KNX	120
Weather station, brightness sensor		
 Weather stations KNX	Meteodata 140 S KNX	122
Brightness and temperature sensors	LUNA 134 KNX/LUNA 131 S KNX/LUNA 133 KNX	124
Display units		
 KNX indoor clocks	OSIRIA KNX	128

Home and building control

KNX, Push-button sensors



Description

iON 102 KNX

- Push-button sensor with 2 buttons and 2 status LEDs with integrated temperature sensor
- Secure communication via KNX-RF with support of „KNX Data Secure“
- For controlling of the functions switching, dimming, blinds, value transmitter, operating mode, scene, color control, sequence
- Up to 3 different telegrams per button
- Sending different telegrams with a short, long or double click
- Multi-colored status LEDs with adjustable colors for each LED separately
- Behavior of each status LED can be set: static, flashing or pulsing
- Brightness of each status LED can be individually adjusted via object or parameter
- Automatic brightness control of the status LEDs depending on the ambient brightness

- Integrated temperature sensor for visualization and temperature control via heating actuators
- Function monitoring via object (signaling dismantling)
- Installation of two iON push button sensors on standard double socket with accessories 9070822 possible
- Transparent cover for individual labeling in the scope of delivery

iON 104 KNX

As iON 102 KNX, but:

- Push-button sensor with 4 buttons and 4 status LEDs

iON 108 KNX

- Room controller with integrated bus unit
- Secure communication via KNX-RF with support of „KNX Data Secure“
- Access to the room controller via Bluetooth and operation with the iONplay app

- LC display for displaying functions, icons and values
- Integrated temperature controller for regulating and controlling the operating mode, temperature and fan level
- 20 freely parameterizable functions
- Free assignment of icons to the functions (40 icons to choose from)
- For controlling of the functions switching, dimming, blinds, value transmitter, operating mode, scene, color control, sequence
- Display brightness individually adjustable via object or parameter
- Automatic brightness control of the display depending on the ambient brightness
- Function monitoring via object (signaling dismantling)
- Installation of two iON push button sensors on standard double socket with accessories 9070822 possible

Product selection

Type	Article number
iON 102 KNX	4969232
iON 104 KNX	4969234
iON 108 KNX	4969238



Technical data

	iON KNX
Operating voltage	Bus voltage, $\leq 12,5$ mA
Ambient temperature	-5 °C ... $+45$ °C
Type of protection	IP 20
Protection class	III

Scale drawings

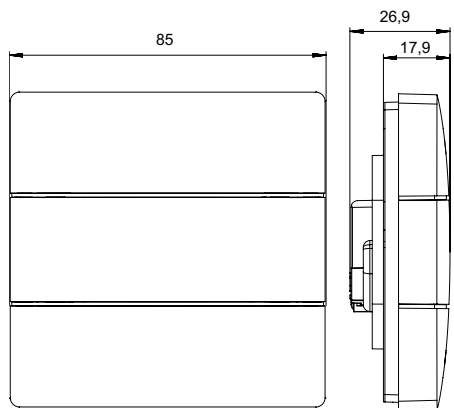

Accessories



2-way mounting plate ION

↳ Art.No.: 9070822

Details page 363

Easy operation via app possible (iON 108 KNX)



Home and building control

KNX, Switching actuators

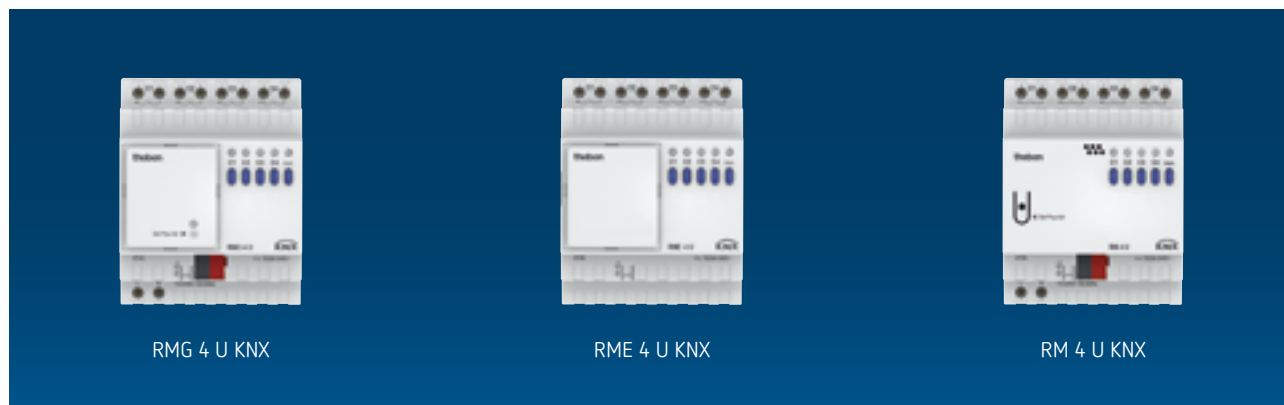

Description

Common functions

- Switching actuator
- LED switching status display for each channel
- Manual operation on device (even without bus connection)
- Switching functions: On/Off, pulse, On/Off delay, staircase light with warning
- Logical links: e.g. lock, AND, release, OR
- Adjustable characteristics: e.g. switching, delayed switching, pulse function
- Links, type of contact (NC contact/NO contact) and participation in central commands such as continuous On, continuous Off, central switching and save/call up scene

RMG 4 U KNX

- 4-way switching actuator MIX2
- Base module MIX2
- Can be upgraded to maximum of 12 channels
- Up to two extension modules MIX or MIX2 can be connected to one base module
- Device and KNX bus module can be swapped independently of each other
- Removable KNX bus module enables devices to be changed without reprogramming
- Manual set-up and use of switching actuators is possible without KNX bus module

RME 4 U KNX

- 4-way switching actuator MIX2
- Extension module MIX2
- For upgrading to maximum of 12 channels

RM 4 U KNX

- 4-way switching actuator

Product selection

Function	Type	Article number
Base module	RMG 4 U KNX	4930223
Extension module	RME 4 U KNX	4930228
Module FIX1	RM 4 U KNX	4940223



Technical data

	RMG 4 U KNX	RME 4 U KNX	RM 4 U KNX
Operating voltage KNX	Bus voltage, ≤ 4 mA	–	Bus voltage, ≤ 4 mA
Operating voltage	110–240 V AC	–	110–240 V AC
Frequency	50–60 Hz	–	50–60 Hz
Stand-by consumption	0,3 W	0,2 W	0,2 W
Width	4 modules		
Max. cable cross section	Solid wire: 0.5 mm ² to 6 mm ² Stranded wire with end sleeve: 0.5 mm ² to 4 mm ²		
Type of contact	NO contact, 16 A (cos φ = 1), 3 A (cos φ = 0,6)		
Inrush current	max. 800 A / 200 μ s		
Resistive load	3680 W		
Incandescent lamp load	2000 W		
Incandescent lamp load	1200 W		
Energy saving lamps	300 W		
LED lamp < 2 W (typ.)	55 W		
LED lamp > 2 W (typ.)	600 W		
Inrush current	max. 800 A / 200 μ s		
Ambient temperature	–5 °C ... +45 °C		
Type of protection	IP 20		
Protection class	II		

Connection diagrams

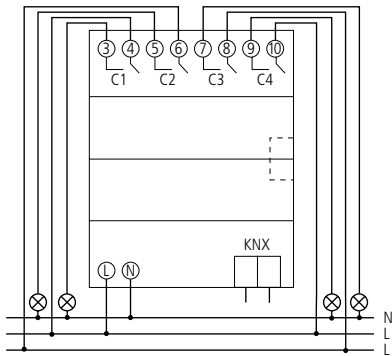

RMG 4 U KNX, RM 4 U KNX

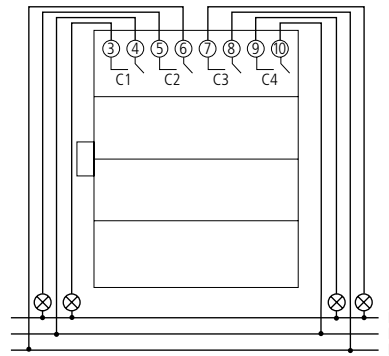

RME 4 U KNX

Home and building control

KNX, Switching actuators

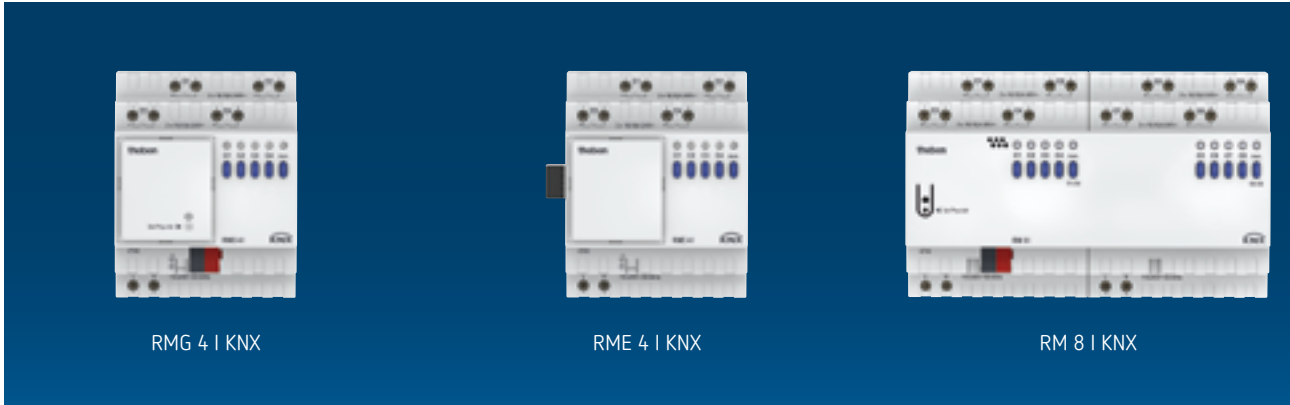

RMG 4 I KNX

RME 4 I KNX

RM 8 I KNX

Description

Common functions

- C load switching actuator
- With current recognition
- For higher lamp loads
- LED switching status display for each channel
- Manual operation on device (even without bus connection)
- Switching functions: On/Off, pulse, On/Off delay, staircase light with warning
- Logical links: e.g. lock, AND, release, OR
- Adjustable characteristics: e.g. switching, delayed switching, pulse function
- Links, type of contact (NC contact/NO contact) and participation in central commands such as continuous On, continuous Off, central switching and save/call up scene

RMG 4 I KNX

- 4-way C load switching actuator MIX2
- Base module MIX2
- Can be upgraded to maximum of 12 channels
- Up to two extension modules MIX or MIX2 can be connected to one base module
- Device and KNX bus module can be swapped independently of each other
- Removable KNX bus module enables devices to be changed without reprogramming
- Manual set-up and use of switching actuators is possible without KNX bus module

RME 4 I KNX

- 4-way C load switching actuator MIX2
- Extension module MIX2
- For upgrading to maximum of 12 channels

RM 8 I KNX

- 8-way C load switching actuator FIX1

RM 4 I KNX

- 4-way C load switching actuator FIX2

Product selection

Function	Type	Article number
MIX2 Base module	RMG 4 I KNX	4930210
MIX2 Extension module	RME 4 I KNX	4930215
FIX1 module	RM 4 I KNX	4940210
FIX2 module	RM 8 I KNX	4940215



Technical data

	RMG 4 KNX	RME 4 KNX	RM 8 KNX	RM 4 KNX
Operating voltage KNX	Bus voltage, $\leq 4 \text{ mA}$	–	Bus voltage, $\leq 4 \text{ mA}$	
Operating voltage	110–240 V AC			
Frequency	50–60 Hz			
Stand-by consumption	1,3 W	1,1 W	2,4 W	1,3 W
Width	4 modules		8 modules	4 modules
Max. cable cross section	Solid wire: 0.5 mm ² to 6 mm ² Stranded wire with end sleeve: 0.5 mm ² to 4 mm ²			
Type of contact	NO contact, 16 A (cos $\phi = 1$), 10 A (cos $\phi = 0,6$)			
Inrush current	max. 1500 A / 200 μs			
Resistive load	3680 W			
Incandescent lamp load	2600 W			
Fluorescent lamp load (electronic ballast)	1650 W			
Energy saving lamps	410 W			
LED lamp < 2 W (typ.)	75 W			
LED lamp > 2 W (typ.)	600 W			
Inrush current	max. 1500 A / 200 μs			
Ambient temperature	–5 °C ... +45 °C			
Type of protection	IP 20			
Protection class	II according to EN 60 669			

Connection diagrams

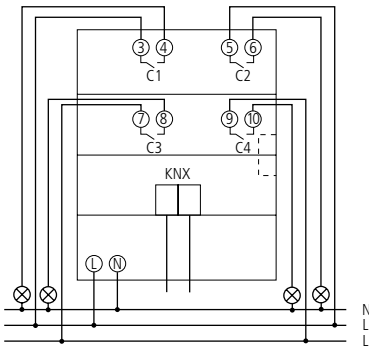

RMG 4 | KNX, RM 4 | KNX

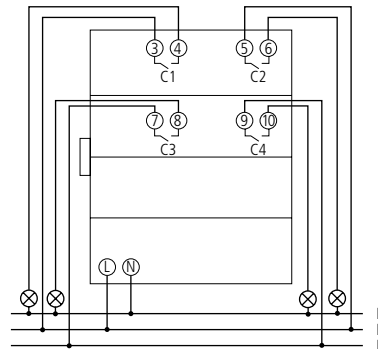

RME 4 | KNX

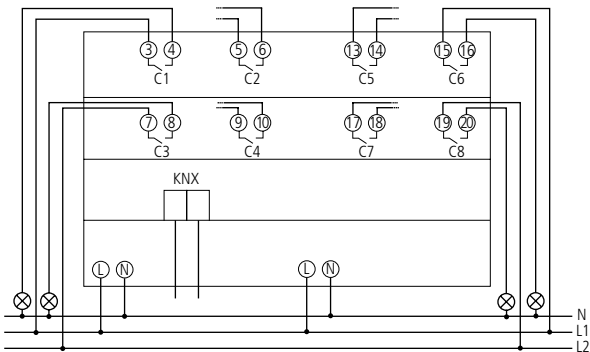

RM 8 | KNX

Home and building control

KNX, Switching actuators

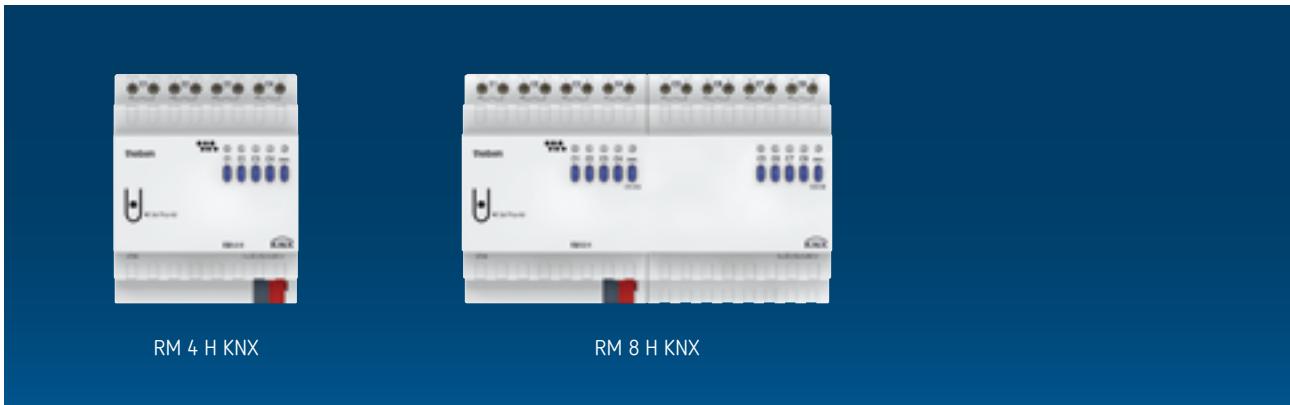

RM 4 H KNX

RM 8 H KNX

Description

Common functions

- High-performance switching actuator
- Bistable relays
- Switching capacity 25 A
- No additional operating voltage needed (only KNX bus voltage)
- LED switching status display for each channel
- Manual operation on device
- Switching functions: On/Off, pulse, On/Off delay, staircase light with warning
- Logical links: e.g. lock, AND, release, OR

RM 4 H KNX

- 4-way high-performance switching actuator FIX1

RM 8 H KNX

- 8-way high-performance switching actuator FIX2

Product selection

Function	Number of channels	Type	Article number
Module FIX1	4	RM 4 H KNX	4940212
Module FIX2	8	RM 8 H KNX	4940217



Technical data

	RM 4 H KNX	RM 8 H KNX
Operating voltage KNX	Bus voltage, ≤ 10 mA	
Width	4 modules	8 modules
Max. cable cross section	Solid wire: 0.5 mm ² to 6 mm ² Stranded wire with end sleeve: 0.5 mm ² to 4 mm ²	
Type of contact	NO contact, 25 A ($\cos \varphi = 1$)	
Energy saving lamps	410 W	
LED lamp < 2 W (typ.)	75 W	
LED lamp > 2 W (typ.)	850 W	
Inrush current	max. 1200 A / 200 μ s	
Ambient temperature	-5 °C ... +45 °C	
Type of protection	IP 20	
Protection class	II according to EN 60 669	

Connection diagrams

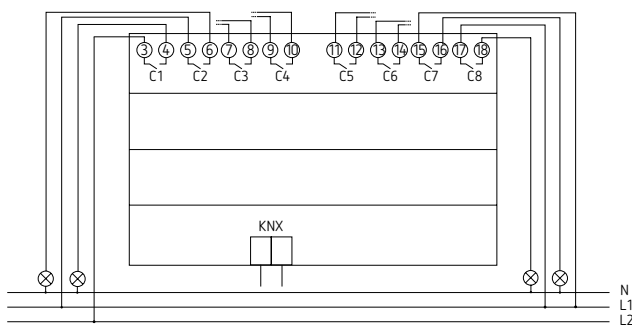

RM 8 H KNX

Home and building control

KNX, Switching actuators

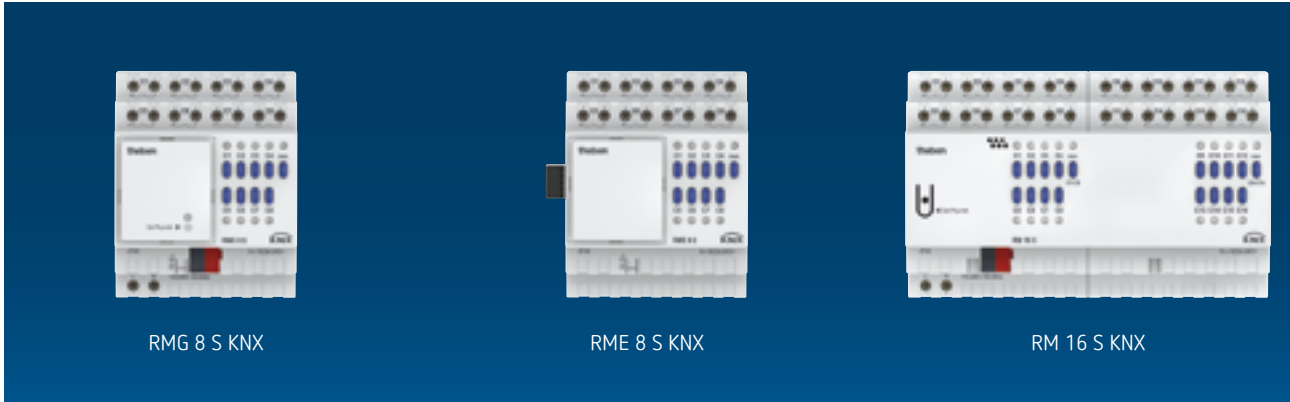

Description

Common functions

- Switching actuator
- LED switching status display for each channel
- Manual operation on device (even without bus connection)
- Switching functions: On/Off, pulse, On/Off delay, staircase light with warning
- Logical links: e.g. lock, AND, release, OR
- Adjustable characteristics: e.g. switching, delayed switching, pulse function
- Links, type of contact (NC contact/NO contact) and participation in central commands such as continuous On, continuous Off, central switching and save/call up scene

RMG 8 S KNX

- 8-way switching actuator MIX2
- Base module MIX2
- Can be upgraded to maximum of 24 channels
- Up to two extension modules MIX or MIX2 can be connected to one base module
- Device and KNX bus module can be swapped independently of each other
- Removable KNX bus module enables devices to be changed without reprogramming
- Manual set-up and use of switching actuators is possible without KNX bus module

RME 8 S KNX

- 8-way switching actuator MIX2
- Extension module MIX2
- For upgrading to maximum of 24 channels

RM 8 S KNX

- 8-way switching actuator FIX1

RM 16 S KNX

- 16-way switching actuator FIX2

Product selection

Function	Type	Article number
MIX2 Base module	RMG 8 S KNX	4930220
MIX2 Extension module	RME 8 S KNX	4930225
FIX1 module	RM 8 S KNX	4940220
FIX2 module	RM 16 S KNX	4940225



Technical data

	RMG 8 S KNX	RME 8 S KNX	RM 8 S KNX	RM 16 S KNX
Operating voltage KNX	Bus voltage, ≤ 4 mA	–	Bus voltage, ≤ 4 mA	
Operating voltage	110–240 V AC	–	110–240 V AC	
Frequency	50–60 Hz	–	50–60 Hz	
Stand-by consumption	0,3 W	0,2 W	0,3 W	
Width	4 modules			8 modules
Max. cable cross section	Solid wire: 0.5 mm ² to 6 mm ² Stranded wire with end sleeve: 0.5 mm ² to 4 mm ²			
Type of contact	NO contact, 16 A (cos φ = 1), 3 A (cos φ = 0,6)			
Inrush current	max. 800 A / 200 μ s			
Resistive load	3680 W			
Incandescent lamp load	2000 W			
Incandescent lamp load	1200 W			
Energy saving lamps	300 W			
LED lamp < 2 W (typ.)	55 W			
LED lamp > 2 W (typ.)	600 W			
Inrush current	max. 800 A / 200 μ s			
Ambient temperature	–5 °C ... +45 °C			
Type of protection	IP 20			
Protection class	II			

Connection diagrams

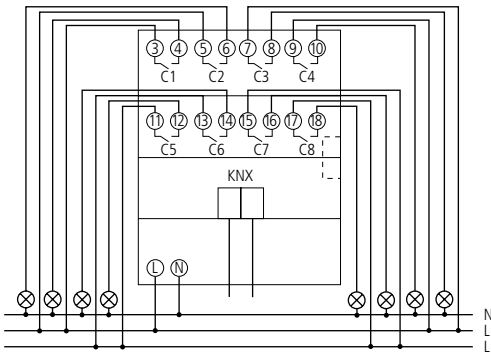

RMG 8 S KNX, RM 8 S KNX

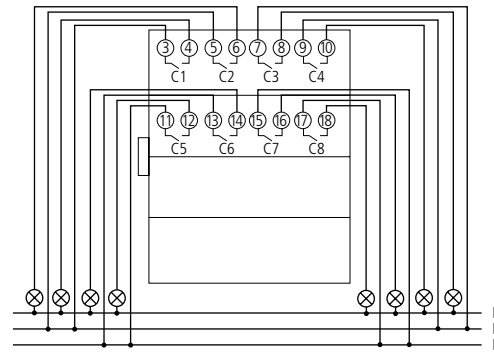

RME 8 S KNX

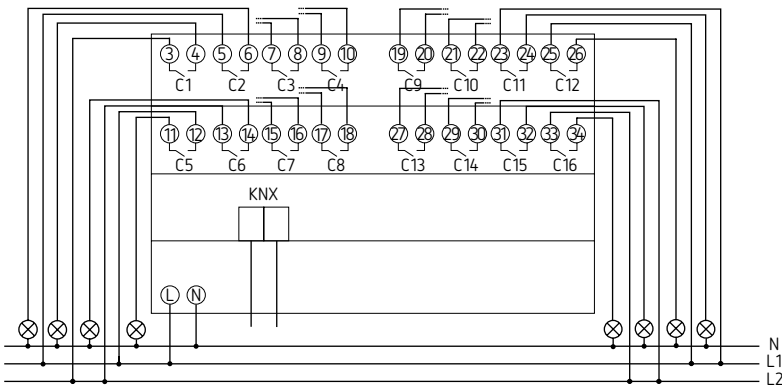

RM 16 S KNX

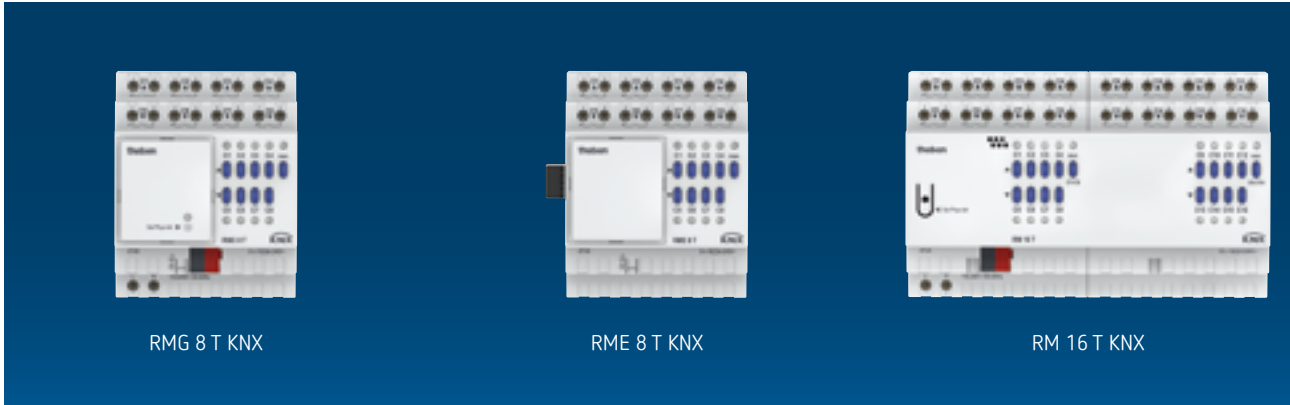

RMG 8 T KNX

RME 8 T KNX

RM 16 T KNX

Description

Common functions

- Switching or blind actuator
- Flexible channel function selection as switching actuator or for controlling drives for blinds, shutters, sun and vision protection devices, skylights and ventilation flaps
- LED switching status display for each channel
- Manual operation on device (even without bus connection)
- Switching functions: On/Off, pulse, On/Off delay, staircase light with warning
- Logical links: e.g. lock, AND, release, OR
- Adjustable characteristics: e.g. switching, delayed switching, pulse function
- Links, type of contact (NC contact/NO contact) and participation in central commands such as continuous On, continuous Off, central switching and save/call up scene

RMG 8 T KNX

- 8-way switching or 4-way blind actuator MIX2
- Base module MIX2
- Can be upgraded to maximum of 24 channels
- Up to two extension modules MIX or MIX2 can be connected to one base module
- Device and KNX bus module can be swapped independently of each other
- Removable KNX bus module enables devices to be changed without reprogramming
- Manual set-up and use of actuator is possible without KNX bus module

RME 8 T KNX

- 8-way switching or 4-way blind actuator MIX2
- Extension module MIX2
- For upgrading to maximum of 24 channels

RM 8 T KNX

- 8-way switching or 4-way blind actuator FIX1

RM 16 T KNX

- 16-way switching or 8-way blind actuator FIX2

Product selection

Function	Type	Article number
MIX2 Base module	RMG 8 T KNX	4930200
MIX2 Extension module	RME 8 T KNX	4930205
FIX1 module	RM 8 T KNX	4940200
FIX2 module	RM 16 T KNX	4940205



Technical data

	RMG 8 T KNX	RME 8 T KNX	RM 16 T KNX	RM 8 T KNX
Operating voltage KNX	Bus voltage, $\leq 4 \text{ mA}$	–	Bus voltage, $\leq 4 \text{ mA}$	
Operating voltage	110–240 V AC	–	110–240 V AC	
Frequency	50–60 Hz	–	50–60 Hz	
Stand-by consumption	0,3 W	0,2 W	0,5 W	
Width	4 modules		8 modules	4 modules
Max. cable cross section	Solid wire: 0.5 mm ² to 6 mm ² Stranded wire with end sleeve: 0.5 mm ² to 4 mm ²			
Type of contact	NO contact, 16 A (cos $\phi = 1$), 3 A (cos $\phi = 0,6$)			
Inrush current	max. 800 A / 200 μs			
Resistive load	3680 W			
Incandescent lamp load	2000 W			
Fluorescent lamp load (electronic ballast)	1200 W			
Energy saving lamps	300 W			
LED lamp < 2 W (typ.)	55 W			
LED lamp > 2 W (typ.)	180 W			
Inrush current	max. 800 A / 200 μs			
Ambient temperature	–5 °C ... +45 °C			
Type of protection	IP 20			
Protection class	II according to EN 60 669			

Connection diagrams

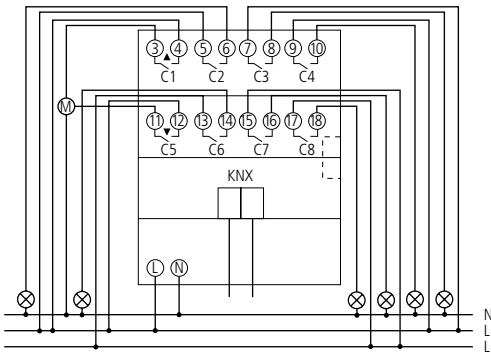

RMG 8 T KNX, RM 8 T KNX

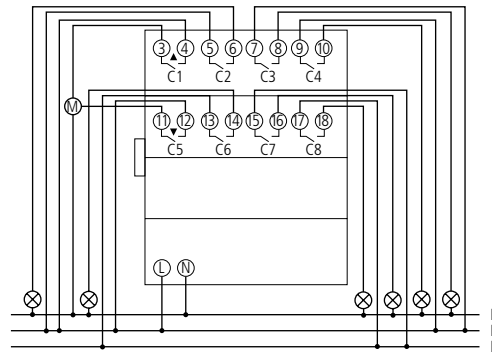

RME 8 T KNX

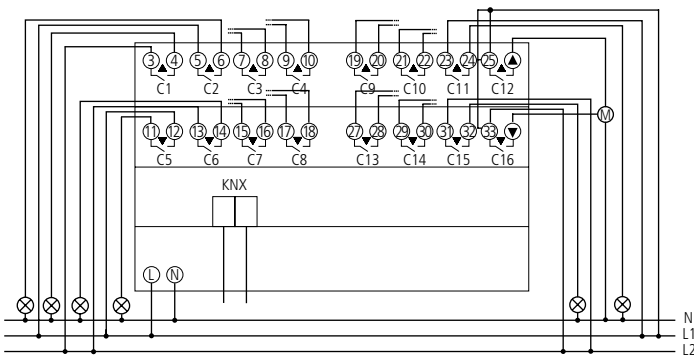

RM 16 T KNX

Home and building control

KNX, Blinds actuators



Description

Common functions

- Blind actuator
- For controlling drives for blinds, shutters, sun and vision protection devices, skylights and ventilation flaps
- Manual operation on device (even without bus connection)
- LED Up and Down switching status display for each channel
- Potential-free contacts for Up and Down per channel
- Copy function for fast configuration
- Setting option for phase sequence and running time of devices

JMG 4 T KNX

- 4-way blind actuator MIX2
- Base module MIX2
- Can be upgraded to maximum of 12 channels
- Up to two extension modules MIX or MIX2 can be connected to one base module
- Device and KNX bus module can be swapped independently of each other
- Removable KNX bus module enables devices to be changed without reprogramming
- Manual set-up and use of actuators is possible without KNX bus module
- Free combination of switches, dimming, blinds and heating control as well as binary inputs

JME 4 T KNX

- 4-way blind actuator MIX2
- Extension module MIX2
- Can be upgraded to maximum of 12 channels

JM 4 T KNX

- 4-way blind actuator FIX1

JM 8 T KNX

- 8-way blind actuator FIX2

Product selection

Function	Type	Article number
MIX2 Base module	JMG 4 T KNX	4930250
MIX2 Extension module	JME 4 T KNX	4930255
FIX1 module	JM 4 T KNX	4940250
FIX2 module	JM 8 T KNX	4940255



Technical data

	JMG 4 T KNX	JME 4 T KNX	JM 8 T KNX	JM 4 T KNX
Operating voltage KNX	Bus voltage, $\leq 4 \text{ mA}$	–	Bus voltage, $\leq 4 \text{ mA}$	
Operating voltage	110–240 V AC	–	110–240 V AC	
Stand-by consumption	0,3 W	0,2 W	0,5 W	0,3 W
Frequency	50–60 Hz	–	50–60 Hz	
Width	4 modules		8 modules	4 modules
Max. cable cross section	Solid wire: 0.5 mm^2 to 6 mm^2 Stranded wire with end sleeve: 0.5 mm^2 to 4 mm^2			
Type of contact	NO contact, 6 A ($\cos \phi = 1$)			
Ambient temperature	$-5 \text{ }^\circ\text{C}$... $+45 \text{ }^\circ\text{C}$			
Type of protection	IP 20			
Protection class	II according to EN 60 669			

Connection diagrams

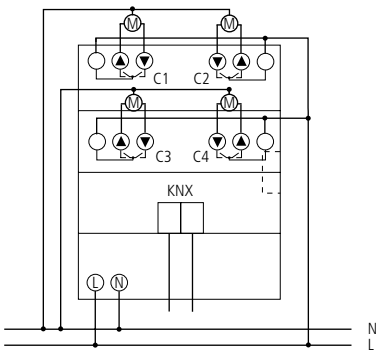

JMG 4 T KNX, JM 4 T KNX

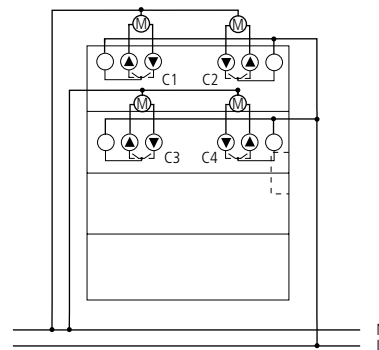

JME 4 T KNX

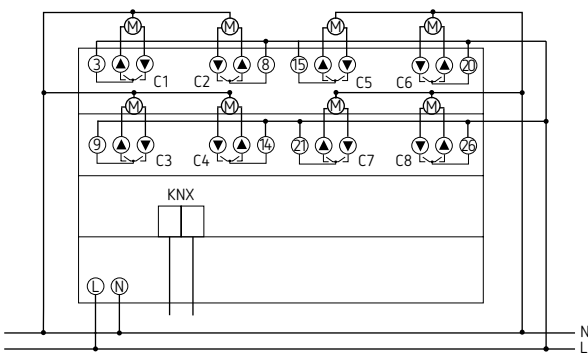

JM 8 T KNX

Home and building control

KNX, Blinds actuators



JMG 4 T 24V KNX

JME 4 T 24V KNX

JM 8 T 24V KNX

Description

Common functions

- Blind actuator
- For controlling 24V drives for blinds, shutters, sun and vision protection devices, skylights and ventilation flaps
- Manual operation on device (even without bus connection)
- LED Up and Down switching status display for each channel
- Potential-free contacts for Up and Down per channel
- Setting option for phase sequence and running time of devices
- Copy function for fast configuration

JMG 4 T 24V KNX

- 4-way blind actuator MIX2
- Base module MIX2
- Can be upgraded to maximum of 12 channels
- Up to two extension modules MIX or MIX2 can be connected to one base module
- Device and KNX bus module can be swapped independently of each other
- Removable KNX bus module enables devices to be changed without reprogramming
- Manual set-up and use of actuators is possible without KNX bus module
- Free combination of switches, dimming, blinds and heating control as well as binary inputs

JME 4 T 24V KNX

- 4-way blind actuator MIX2
- Extension module MIX2
- Can be upgraded to maximum of 12 channels

JM 4 T 24V KNX

- 4-way blind actuator FIX1

JM 8 T 24V KNX

- 8-way blind actuator FIX2

Product selection

Function	Type	Article number
MIX2 Base module	JMG 4 T 24V KNX	4930260
MIX2 Extension module	JME 4 T 24V KNX	4930265
FIX1 module	JM 4 T 24V KNX	4940260
FIX2 module	JM 8 T 24V KNX	4940265



Technical data

	JMG 4 T 24V KNX	JME 4 T 24V KNX	JM 4 T 24V KNX	JM 8 T 24V KNX
Operating voltage KNX	Bus voltage, $\leq 4 \text{ mA}$	–	Bus voltage, $\leq 4 \text{ mA}$	
Operating voltage	110–240 V AC	–	110–240 V AC	
Stand-by consumption	0,3 W	–	0,3 W	0,5 W
Frequency	50–60 Hz	–	50–60 Hz	
Width	4 modules			8 modules
Max. cable cross section	Solid wire: 0.5 mm ² to 6 mm ² Stranded wire with end sleeve: 0.5 mm ² to 4 mm ²			
Type of contact	Changeover contact			
Switching capacity	6 A (at 24 V DC)			
Ambient temperature	–5 °C ... +45 °C			
Type of protection	IP 20			
Protection class	II according to EN 60 730-1			

Connection diagrams

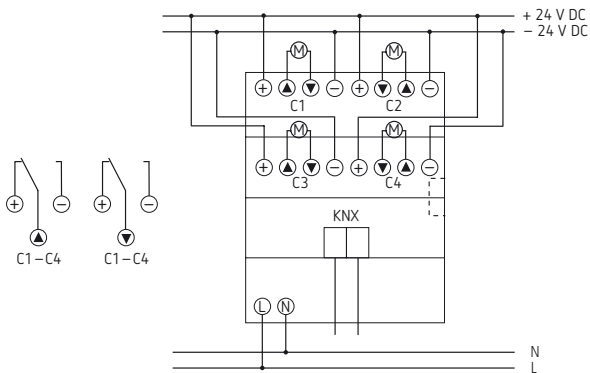

JMG 4 T 24V KNX, JM 4 T 24V KNX

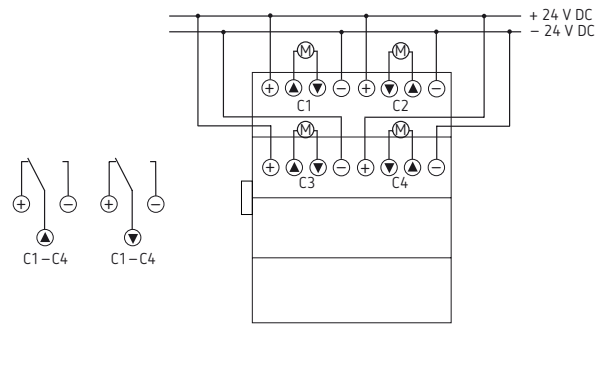

JME 4 T 24V KNX

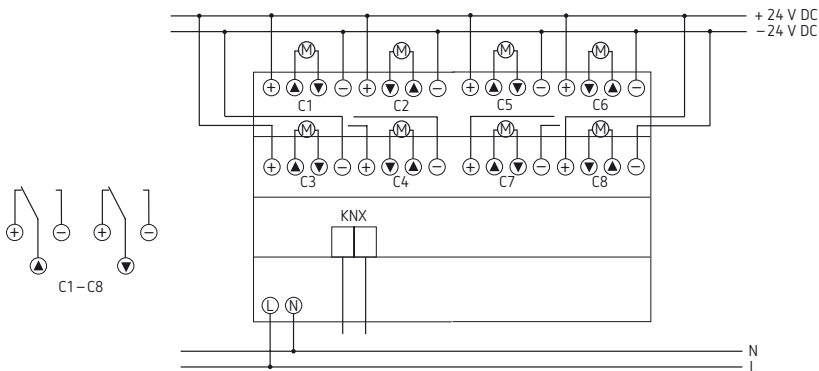

JM 8 T 24V KNX

Home and building control

KNX, Blinds actuators



Description

Common functions

- Universal dimmer actuator
- For dimming dimmable LED, incandescent lamps, LV, HV halogen lamps and energy saving lamps
- Also suitable for dimming of dimmable energy-saving lamps
- Also suitable for controlling fans
- LED switching status display for each channel
- Manual operation on device (even without bus connection)
- The dimming output can be upgraded by using additional dimmboosters „DMB 1 T KNX“ - dimming output 300 W/VA (incandescent lamp) for each dimmbooster. Output to a maximum of 2000 W/VA (incandescent lamp) by using max. 4 boosters possible
- Automatic load detection (can be deactivated)
- For R, L and C loads

DMG 2 T KNX

- 2-way universal dimmer actuator MIX2
- Base module MIX2
- Can be upgraded to maximum of 6 channels
- Up to two extension modules MIX or MIX2 can be connected to one base module
- Device and KNX bus module can be swapped independently of each other
- Removable KNX bus module enables devices to be changed without reprogramming
- Manual set-up and use of switching actuators is possible without KNX bus module
- Dimming output: 400 W per channel or 800 W in parallel operation

DME 2 T KNX

- 2-way universal dimmer actuator MIX2
- Extension module MIX2
- For upgrading to maximum of 6 channels

DM 2 T KNX

- 2-way universal dimmer actuator FIX1

DM 4 T KNX

- 4-way universal dimmer actuator FIX2

DMB 1 T KNX

- 1 channel dimming output extension module ‚Dimmbooster‘

Product selection

Function	Type	Article number
MIX2 Base module	DMG 2 T KNX	4930270
MIX2 Extension module	DME 2 T KNX	4930275
FIX1 module	DM 2 T KNX	4940270
FIX2 module	DM 4 T KNX	4940275
Dimmbooster	DMB 1 T KNX	4930279

Technical data

	DMG 2 T KNX	DME 2 T KNX	DM 4 T KNX	DM 2 T KNX	DMB 1 T KNX
Operating voltage KNX	Bus voltage, ≤ 4 mA	–	Bus voltage, ≤ 4 mA		–
Operating voltage	230 V AC				
Frequency	50 Hz				
Stand-by consumption	0,9 W	0,6 W	1,5 W	–	0,2 W
Width	4 modules		8 modules	4 modules	1 modules



	DMG 2 T KNX	DME 2 T KNX	DM 4 T KNX	DM 2 T KNX	DMB 1 T KNX
Max. cable cross section	Solid wire: 0.5 mm ² to 6 mm ² Stranded wire with end sleeve: 0.5 mm ² to 4 mm ²				
Lamp types	Incandescent, low-voltage and high-voltage halogen and dimmable energy saving lamps and LED			Incandescent, low-voltage and high-voltage halogen and dimmable LED	
Switching capacity per channel	400 W			300 W	
Switching capacity in parallel operation	800 W			-	
Dimming capacity LED lamp (typ.) per channel	Trailing edge (RC-mode): 400 W			45 W	
Dimming capacity LED lamp (typ.) in parallel operation	Trailing edge (RC-mode): 800 W			-	
Dimming capacity energy saving lamps per channel	Trailing edge (RC-mode): 80 W			-	
Dimming capacity energy saving lamps in parallel operation	Trailing edge (RC-mode): 140 W			-	
Switching capacity min.	5 W				
Ambient temperature	-5 °C ... +45 °C				
Type of protection	IP 20				
Protection class	II according to EN 60 669				

Connection diagrams

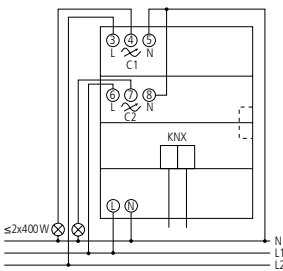

DMG 2 T KNX, DM 2 T KNX

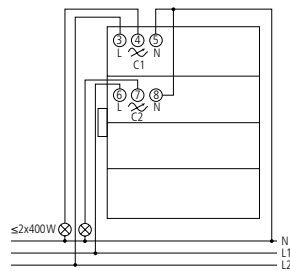

DME 2 T KNX

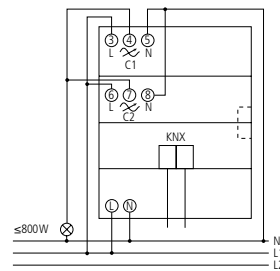

DMG 2 T KNX, DM 2 T KNX

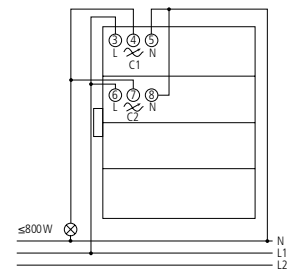

DME 2 T KNX

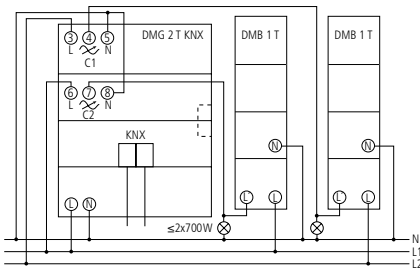

DMG 2 T KNX, DMB 1 T KNX

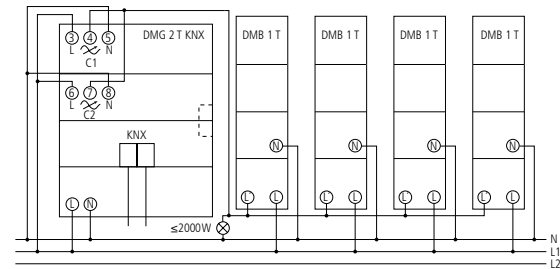

DMG 2 T KNX, DM 2 T KNX

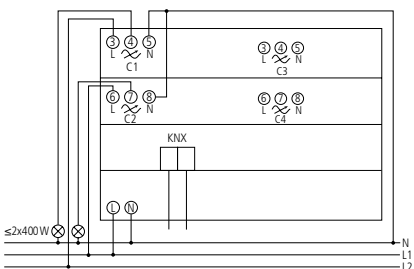

DM 4 T KNX

Home and building control

KNX, Dimming actuators



DM 4-2 T KNX

DM 8-2 T KNX

Description

Common functions

- Universal dimmer actuator
- For dimming dimmable LED, incandescent lamps, LV, HV halogen lamps and energy saving lamps
- Also suitable for dimming of dimmable energy-saving lamps
- Also suitable for controlling fans

- LED switching status display for each channel
- Manual operation on device
- Dimming output: 200 W per channel or 400 W in parallel operation
- Automatic load detection (can be deactivated)
- For R, L and C loads

DM 4-2 T KNX

- 4-way universal dimmer actuator FIX1

DM 8-2 T KNX

- 8-way universal dimmer actuator FIX2

Description

Function	Number of channels	Type	Article number
FIX1 module	4	DM 4-2 T KNX	4940280
FIX2 module	8	DM 8-2 T KNX	4940285



Technical data

	DM 4-2 T KNX	DM 8-2 T KNX
Operating voltage KNX	Bus voltage, ≤ 10 mA	Bus voltage, $\leq 17,5$ mA
Operating voltage	230–240 V AC	
Frequency	50–60 Hz	
Stand-by consumption	< 1 W	
Width	4 modules	8 modules
Max. cable cross section	Solid wire: 0.5 mm ² to 6 mm ² Stranded wire with end sleeve: 0.5 mm ² to 4 mm ²	
Lamp types	Incandescent, low-voltage and high-voltage halogen and dimmable energy saving lamps and LED	
Switching capacity per channel	200 W	
Switching capacity in parallel operation	400 W	
Dimming capacity LED lamp (typ.) per channel	Trailing edge (RC-mode): 200 W	
Dimming capacity LED lamp (typ.) in parallel operation	Trailing edge (RC-mode): 400 W	
Dimming capacity energy saving lamps per channel	Trailing edge (RC-mode): typ. 200 W	
Dimming capacity energy saving lamps in parallel operation	Trailing edge (RC-mode): typ. 400 W	
Switching capacity min.	2 W	
Ambient temperature	-5 °C ... $+45$ °C	
Type of protection	IP 20	
Protection class	II according to EN 60 669	

Connection diagrams

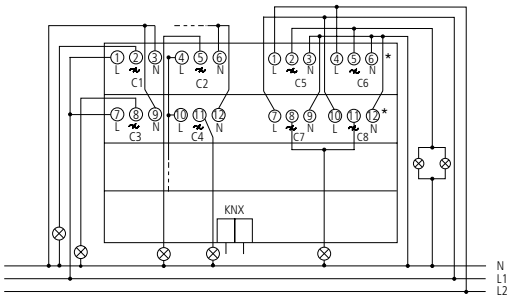

DM 8-2 T KNX

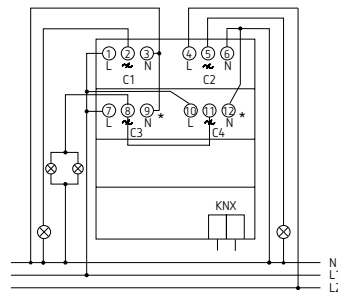

DM 4-2 T KNX

Home and building control

KNX, Dimming actuators



SMG 2 S KNX

SME 2 S KNX

Description

Common functions

- 2-way 1–10 V control unit MIX
- Free combination of switching, dimming, blinds and heating control as well as binary inputs
- Switching and dimming of lighting circuits in combination with electronic ballasts (EBs and ballasts LED)

- 1–10 V inputs and one switch output (relay contact) per channel
- LED switching status display for each channel
- Manual switch with On/Off/Bus settings (also without bus voltage)
- Zero-cross switching for relay-saving switching and high lamp loads

SMG 2 S KNX

- Base module MIX
- Can be upgraded to maximum of 6 channels

SME 2 S KNX

- Extension module MIX
- For upgrading to maximum of 6 channels

Product selection

Type	Article number
SMG 2 S KNX	4910273
SME 2 S KNX	4910274

Technical data

	SMG 2 S KNX	SME 2 S KNX
Operating voltage KNX	Bus voltage, ≤ 10 mA	–
Operating voltage	230 V AC	
Frequency	50 Hz	
Stand-by consumption	1,6 W	
Width	4 modules	
Max. cable cross section	Solid wire: 0.5 mm ² to 6 mm ² Stranded wire with end sleeve: 0.5 mm ² to 4 mm ²	
Type of contact	NO contact, 16 A (cos φ = 1), 10 A (cos φ = 0,6)	
Incandescent/halogen lamp load	2500 W	
Ambient temperature	–5 °C ... +45 °C	
Type of protection	IP 20	
Protection class	II according to EN 60 730-1	

Connection diagrams

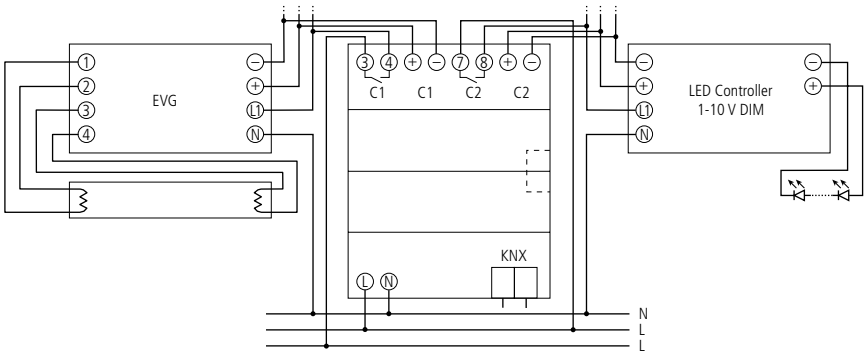

Home and building control

KNX, Gateways



DALI-Gateway KNX plus

Description

- The DALI Gateway KNX serves as an interface between the the DALI and the KNX system
- A maximum of 64 DALI members can be connected to a DALI output
- Control in 16 groups or in individual control
- Color light control with Device Type 8 (DT8) for 16 groups: Color temperature, XY, RGB, HSV, RGBW
- Time-dependent color control (also for human centric lighting applications)
- Scene module for 16 scenes (including color setting DT8)
- Effects module for sequential controls (including color setting DT8): Color temperature, XY, RGB, HSV, RGBW
- Energy saving by switching off the electronic ballast power supply in the groups (communication object)
- Easy replacement of ECGs in the event of an error
- Support of single-battery emergency lights (DT1) and emergency light systems with central battery
- LC display (2x 12 characters) for menu guidance during start-up and parameter settings
- Commissioning using the controls on the device, the integrated web server or the free ETS app (DCA)

Product selection

Type	Article number
DALI-Gateway KNX plus	9070929

Technical data

DALI-Gateway KNX plus			
Operating voltage KNX	Bus voltage, <10 mA	Ambient temperature	-5 °C ... +45 °C
Operating voltage	100–240 V AC/DC	Protection class	I
Frequency	50–60 Hz	Type of protection	IP 20
Width	4 modules		



Description

Common functions

- The DALI Gateway KNX serves as an interface between the DALI and the KNX system
- A maximum of 64 DALI members can be connected to a DALI output
- Control in 16 groups
- Colour light control with Device Type 8 (DT8) for 16 groups: Colour temperature, XY, RGB, HSV, RGBW
- Time-dependent colour control (also for human centric lighting applications)

- Scene module for 16 scenes (including colour setting DT8)
- Effects module for sequential controls (including colour setting DT8): Colour temperature, XY, RGB, HSV, RGBW
- Energy saving by switching off the electronic ballast power supply in the groups (communication object)
- Easy replacement of ECGs in the event of an error
- Commissioning using the free ETS app (DCA)

DALI-Gateway S64 KNX

- 1 Kanal für 64 DALI-Leuchten

DALI-Gateway S128 KNX

- 2 Kanäle für 2x64 DALI-Leuchten

Product selection

Type	Article number
DALI-Gateway S64 KNX	4940301
DALI-Gateway S128 KNX	4940302

Technical data

DALI-Gateway S64/S128 KNX			
Operating voltage KNX	Bus voltage, < 10 mA	Ambient temperature	-5 °C ... +45 °C
Operating voltage	100–240 V AC/DC	Protection class	I
Frequency	50–60 Hz	Type of protection	IP 20
Width	4 modules		

Home and building control

KNX, Flush-mounted actuators



Description

Common functions

- 1-way flush-mounted actuator
- Secure communication via with support of „KNX Data Secure“
- Easy installation due to the compact housing
- 2 binary inputs for floating contacts such as buttons, switches, window contacts, temperature sensor (I2)
- Integrated temperature monitoring for increased operating safety, e.g. in the event of overload

SU 1 KNX

- 1-way flush-mounted switching actuator
- 1x NO contact & 1x NC contact with common control
- Adjustable features: NC/NO contact, switching, delayed switching, pulse function
- The binary inputs are assigned to the switch output as standard (function test before programming)

JU 1 KNX

- 1-way flush-mounted blind / switching actuator
- For controlling drives for blinds, roller blinds, sun and vision protection devices, skylights, and ventilation flaps
- Integrated automatic ventilation function
- Flexible configuration options: blind actuator or 2-channel switch actuator
- The binary inputs are assigned to the output as standard (function test before programming)

DU 1 KNX

- 1-way flush-mounted dimming actuator
- Optimised dimming output for dimmable energy-saving lamps, LEDs, incandescent and halogen lamps, and dimmable transformers
- Easy to adapt to different lamps thanks to automatic load detection

- Adjustable dimming curve for precise and flicker-free dimming
- The binary inputs are assigned to the dimming output as standard (function test before programming)

HU 1 KNX

- 1-way flush-mounted heating actuator
- Noiseless control of thermal actuators 230 V AC
- Function selection as a heating actuator (continuous or switching) or as a heating controller (integrated temperature controller heating / cooling)
- Valve protection function and summer function

Product selection

Number of channels	Funktionsart	Type	Article number
1	Flush-mounted switching actuator	SU 1 KNX	4942520
	Flush-mounted blind/switching actuator	JU 1 KNX	4942550
	Flush-mounted dimming actuator	DU 1 KNX	4942570
	Flush-mounted heating actuator	HU 1 KNX	4942540

Technical data

	DU 1 KNX	JU 1 KNX	SU 1 KNX	HU 1 KNX
Operating voltage KNX	Bus voltage, ≤ 4 mA			
Energy saving lamps	-		300 W	-
LED lamp < 2 W (typ.)	Trailing edge (RC-mode): 250 W	-	50 W	-
LED lamp > 2 W (typ.)	Trailing edge (RC-mode): 250 W	-	600 W	-
Switching capacity	-	10 A	16 A	max. 1 A or 4 actuators 230 V AC (ALPHA 5)
Ambient temperature	-5 °C ... +45 °C			
Protection class	II			

Connection examples

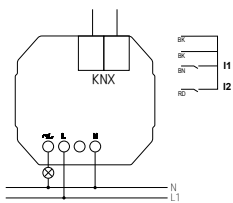

DU 1 KNX

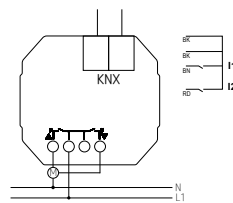

JU 1 KNX

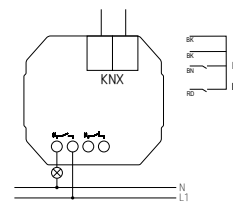

SU 1 KNX

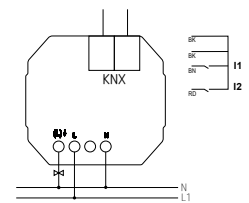

HU 1 KNX

Accessories



Temperature sensor RAMSES
IP 65
↳ Art.No.: 9070459
Details page 361



Temperature sensor
↳ Art.No.: 9070321
Details page 361



Flush-mounted temperature
sensor
↳ Art.No.: 9070469
Details page 361



Actuator ALPHA 5 230 V
for HU 1 KNX
↳ Art.No.: 9070441
Details page 361

Scale drawings

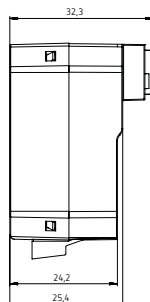
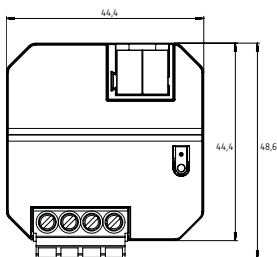

Home and building control

KNX, Flush-mounted actuators

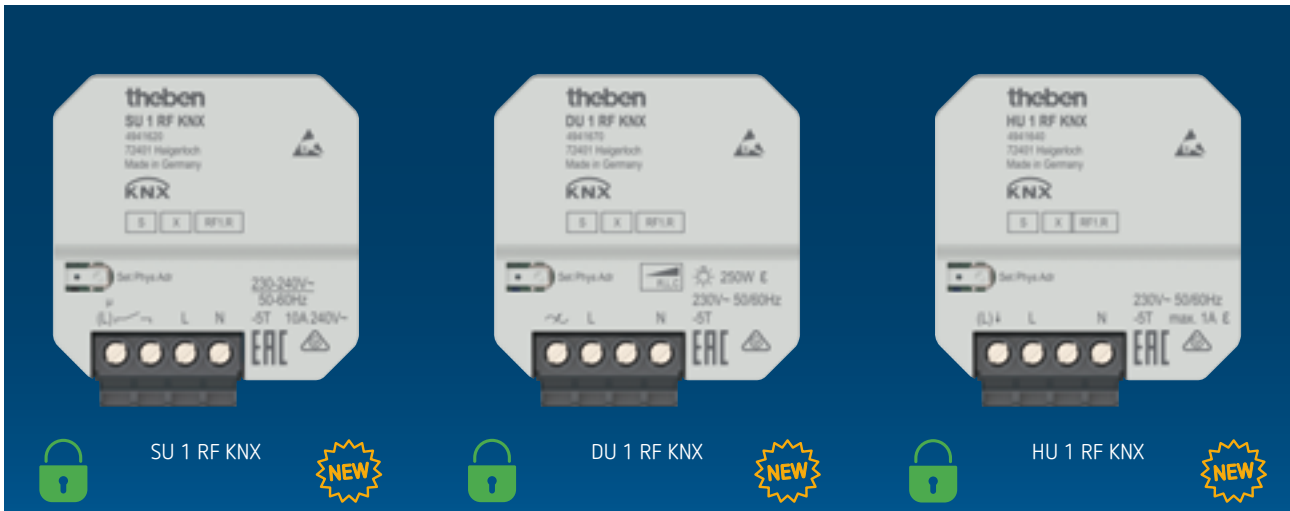

Description

Common functions

- 1-way wireless flush-mounted actuator
- Secure communication via KNX-RF with support from KNX Data Secure
- Easy installation due to the compact housing
- 2 binary inputs for floating contacts such as buttons, switches, temperature sensor (I2)
- Integrated temperature monitoring for increased operating safety, e.g. in the event of overload

SU 1 RF KNX

- 1-way wireless flush-mounted switch actuator
- Adjustable features: NC/NO contact, switching, delayed switching, pulse function
- The binary inputs are assigned to the switch output as standard (function test before programming)

DU 1 RF KNX

- 1-way wireless flush-mounted dimming actuator
- Optimised dimming output for dimmable energy-saving lamps, LEDs, incandescent and halogen lamps, and dimmable transformers.
- Easy to adapt to different lamps thanks to automatic load detection
- Adjustable dimming curve for precise and flicker-free dimming
- The binary inputs are assigned to the dimming output as standard (function test before programming)

JU 1 RF KNX

- 1-way wireless flush-mounted blind actuator

- For controlling drives for blinds, roller blinds, sun and vision protection devices, skylights, and ventilation flaps
- Integrated automatic ventilation function
- The binary inputs are assigned to the output as standard (function test before programming)

HU 1 RF KNX

- 1-way wireless flush-mounted heating actuator
- Silent control of 230 V AC thermal actuators
- Integrated heating/cooling temperature controller
- Valve protection function

Product selection

Configuration type	Number of channels	Type	Article number
Switch actuator	1	SU 1 RF KNX	4941620
Dimming actuator	1	DU 1 RF KNX	4941670
Blind actuator	1	JU 1 RF KNX	4941650
Heating actuator	1	HU 1 RF KNX	4941640

Technical data

	SU 1 RF KNX	DU 1 RF KNX	JU 1 RF KNX	HU 1 RF KNX
Operating voltage	230–240 V AC	230 V AC	230–240 V AC	230 V AC
Frequency	50–60 Hz			
Switching capacity	10 A	–	5 A	max. 1 A or 4 actuators 230 V AC (ALPHA 5)
Incandescent/halogen lamp load	1800 W	250 W	–	–
LED lamp (typ.)	600 W	Trailing edge (RC-mode): 250 W	–	–
Ambient temperature	–5 °C ... +45 °C			
Protection rating	IP 20			
Protection class	II			

Connection examples

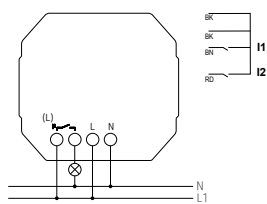

SU 1 RF KNX

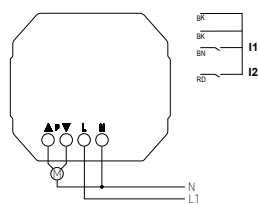

JU 1 RF KNX

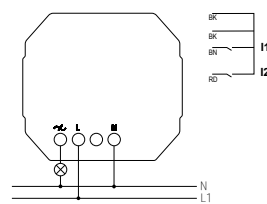

DU 1 RF KNX

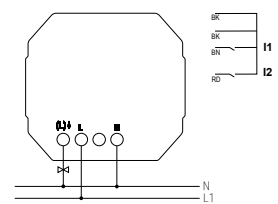

HU 1 RF KNX

Accessories



Temperature sensor RAMSES
IP 65
↳ Art.No.: 9070459
Details page 361



Temperature sensor
↳ Art.No.: 9070321
Details page 361



Flush-mounted temperature
sensor
↳ Art.No.: 9070469
Details page 361



Actuator ALPHA 5 230 V
for HU 1 RF KNX
↳ Art.No.: 9070441
Details page 362

Scale drawings

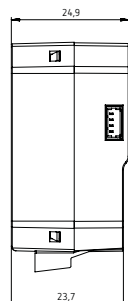
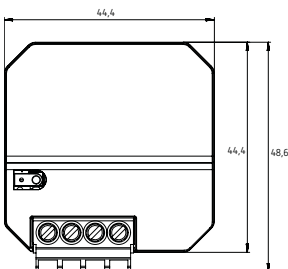

Home and building control

KNX, Binary inputs / Media coupler



Description

TU 4 RF KNX

- 4-way flush-mounted wireless push-button interface
- Secure communication via with support of „KNX Data Secure“
- 4 binary inputs for potential-free buttons and signaling contacts
- 1 additional input for temperature sensor
- Free assignment of the functions switching, dimming, blinds, temperature measurement and transmission
- Easy installation due to the compact housing
- Can be used with 4-way push-button module (9070806)

Media coupler TP-RF KNX

- Connects KNX RF devices of a radio line with the twisted-pair bus
- Power supply via KNX bus voltage
- Supports long frames for „KNX Secure“ and enables faster download of large applications in parallel
- Ranges of max. 30 m within the building are possible
- Has a repeater function, i.e. received telegrams are sent again to increase the range

Product selection

Type	Article number
TU 4 RF KNX	4961604
Media coupler TP-RF KNX	9070868



Technical data

	TU 4 RF KNX	Media coupler TP-RF KNX
Operating voltage	230–240 V AC	Bus voltage
Frequency	50–60 Hz	–
Stand-by consumption	< 0,4 W	–
Length connecting wires	25 cm	–
Interface extension max.	3 m	–
Ambient temperature	–5 °C ... +45 °C	
Protection class	II	–

Accessories



4-way push-button module

For TU 4 RF KNX, with integrated temperature sensor
Details page 363

Cover frame

For 4-way push-button module,
for common switch ranges
Details page 357

Flush-mounted temperature sensor

↳ Art.No.: 9070469
Details page 361

Connection examples

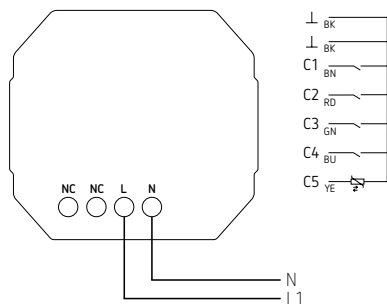

TU 4 RF KNX

Scale drawings

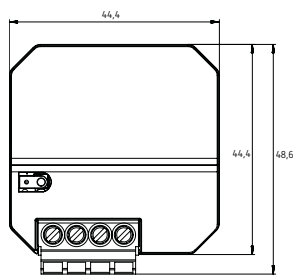

TU 4 RF KNX

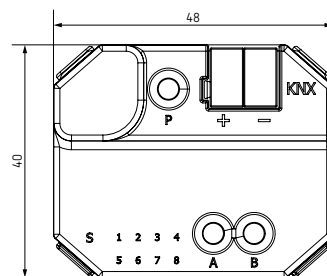
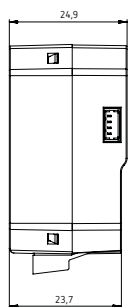

Medienkoppler TP-RF KNX

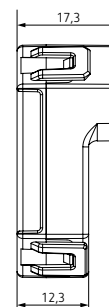

Home and building control

KNX, Binary inputs / Media coupler



Description

Common functions

- Binary input
- LED switching status display for each channel
- Manual operation on device (even without bus connection)
- Manual operation per channel for simulating the input states
- All inputs can be operated with different voltages and at different potentials
- Connectable cable length up to 100 m
- Free allocation of functions: switch/push button, dimming, blinds/roller blinds, counter, repeat telegram, sequences

BMG 6 T KNX

- 6-way binary input MIX2
- Base module MIX2
- Can be upgraded to maximum of 18 channels
- 6 floating universal and wide-range voltage inputs (10–240 V AC/DC or internally generated auxiliary voltage of approx. 12 V DC)
- 2 additional channels operable by buttons on the device, but without input
- Up to two extension modules MIX or MIX2 can be connected to one base module
- Device and KNX bus module can be swapped independently of each other
- Removable KNX bus module enables devices to be changed without reprogramming
- Manual set-up and use of actuator is possible without KNX bus module

BME 6 T KNX

- 6-way binary input MIX2
- Extension module MIX2
- For upgrading to maximum of 18 channels

BM 6 T KNX

- 6-way binary input FIX1
- 6 floating universal and wide-range voltage inputs (10–240 V AC/DC or internally generated auxiliary voltage of approx. 12 V DC)
- 2 additional channels operable by buttons on the device, but without input

BM 12 T KNX

- 12-way binary input FIX2
- 12 floating universal and wide-range voltage inputs (10–240 V AC/DC or internally generated auxiliary voltage of approx. 12 V DC)
- 4 additional channels operable by buttons on the device, but without input

Product selection

Function	Type	Article number
MIX2 Base module	BMG 6 T KNX	4930230
MIX2 Extension module	BME 6 T KNX	4930235
FIX1 module	BM 6 T KNX	4940230
FIX2 module	BM 12 T KNX	4940235



Technical data

	BMG 6 T KNX	BME 6 T KNX	BM 12 T KNX	BM 6 T KNX
Operating voltage KNX	Bus voltage, ≤ 4 mA	–	Bus voltage, ≤ 4 mA	
Operating voltage	110–240 V AC	–	110–240 V AC	
Frequency	50–60 Hz	–	50–60 Hz	
Stand-by consumption	0,3 W	–	0,5 W	0,3 W
Width	4 modules		8 modules	4 modules
Max. cable cross section	Solid wire: 0.5 mm ² to 6 mm ² Stranded wire with end sleeve: 0.5 mm ² to 4 mm ²			
Voltage inputs	10 V DC – 240 V AC 2 mA			
Ambient temperature	–5 °C ... +45 °C			
Type of protection	IP 20			
Protection class	II according to EN 60 730-1			

Connection diagrams

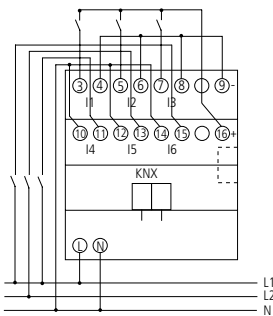

BMG 6 T KNX, BM 6 T KNX

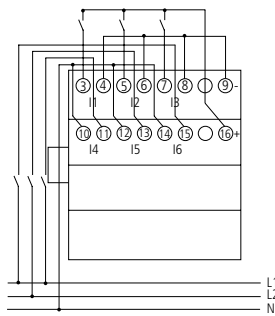

BME 6 T KNX

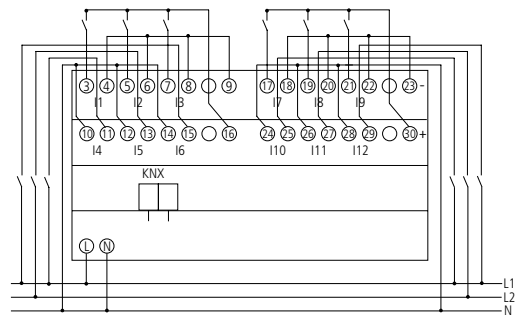

BM 12 T KNX

Home and building control

KNX, Binary inputs



Description

Common functions

- Binary input/binary output sensor interfaces
- Can be installed in flush-mounted sockets with conventional sensors/switches
- Flexible LED controlling, thanks to increased output current of 3 mA commercially available LEDs and low current LEDs can be controlled
- Inputs can be reconfigured to outputs with parameterizable flashing and pulsing function
- Colour coding of wiring pairs

TA 2 S KNX

- 2-way key interface
- 4-pole cable connection
- Free allocation of functions: Switch/key, dimming, blinds, valuator, sequences, controlling LED

TA 4 S KNX

- 4-way key interface
- 6-pole cable connection
- Free allocation of functions: Switch/key, dimming, blinds, valuator, sequences, measuring temperature, controlling LED

- 2 NTC inputs for detection of the actual temperature

TA 6 S KNX

- As TA 4 S KNX, but:
- 6-way key interface
 - 8-pole cable connection
 - Can be used with 4-way push-button module (9070806)

TA 8 S KNX

- As TA 4 S KNX, but:
- 8-way key interface
 - 10-pole cable connection

Product selection

Type	Article number
TA 2 S KNX	4969222
TA 4 S KNX	4969224
TA 6 S KNX	4969226
TA 8 S KNX	4969228



Technical data

	TA S KNX
Operating voltage KNX	Bus voltage, ≤ 10 mA
Length connecting wires	25 cm
Contact current	0,5 mA
Ambient temperature	-5 °C ... +45 °C
Type of protection	IP 20
Protection class	III

Accessories

Flush-mounted temperature sensor

Details page 361

Temperature sensor

Details page 361

Temperature sensor RAMSES IP 65

Details page 361

Contact temperature sensor

Details page 361

4-way push-button module (for TA 6 S KNX)

Details page 363

Scale drawings

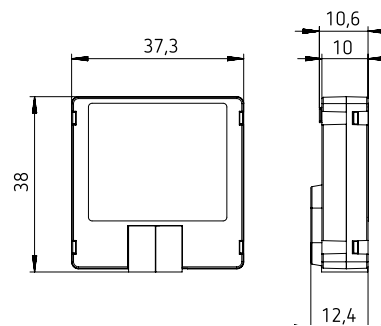

Home and building control

KNX, Presence detectors



Description

Common functions

- KNX Passive infrared presence detector for ceiling mounting
- Square detection range of 360° for safe and easy planning
- Mixed light measurement suitable for LEDs, fluorescent lamps (FL/PL/ESL) and halogen/incandescent lamps
- Can be used as fully or semi-automatic, switchable
- Switch or constant light control mode with stand-by function
- Dimmable lighting in switch mode with stand-by function
- Brightness switching value or set point value can be set in lux using parameters, on the device itself or via remote control
- Teaching in of the brightness switching value or the set point value

- Room correction factor setting for brightness measurement calibration
- Light time delay can be set using parameters, on the device itself or via remote control
- Switch on delay and time delay for presence can be set
- Detection sensitivity can be set
- Self-learning time delay
- Reduced time delay in the event of a shorter stay in the room (short presence)
- Scenario functions
- Extremely easy setting of energy saving characteristics with the new „eco plus“ function
- Test mode for checking function and detection range
- Parallel switching of several detectors in Master/Slave or Master/Master possible

- User remote control and management-remote control (optional)
 - Room monitoring
- thePrema P360 KNX UP**
- 3 channels light and 2 channels presence
 - 2 channels light C1, C2 with 2 light measurements and additional lighting channel C3 without brightness factor
 - 2 presence channels can be set individually
 - Adaptable 3 channels light measurement
- thePrema S360 KNX UP**
- 2 channels light and 2 channels presence
 - 2 channels light C1, C2 with 1 light measurement
 - 2 presence channels can be set individually with parallel offset
 - Adaptable 1 channel light measurement

* According to warranty terms and conditions, see www.theben.de/en/guarantee

Product selection

Channels	Colour	Type	Article number
3x light/2x presence	White	thePrema P360 KNX UP WH	2079000
	Grey	thePrema P360 KNX UP GR	2079001
2x light/ 2x presence	White	thePrema S360 KNX UP WH	2079500
	Grey	thePrema S360 KNX UP GR	2079501

Technical data

	thePrema P360 KNX UP	thePrema S360 KNX UP
Operating voltage KNX	Bus voltage, approx. 9 mA (13 mA LED on)	Bus voltage, approx. 8 mA (12 mA LED on)
Installation height	2–10 m	2–3,5 m
Setting range brightness	approx. 5–3000 lx/measuring off	
Light switch-off delay	30 s–60 min	
Stand-by dimming value	1–25 % of the lamp output	
Stand-by time	30 s–60 min/inactive/permanently on	



	thePrema P360 KNX UP	thePrema S360 KNX UP
Presence switch-off delay	10 s – 120 min	
Presence switch-on delay	10 s – 30 min / inactive	
Ambient temperature	0 °C ... +50 °C	
Type of protection	IP 40 (when fitted)	

Detection range thePrema P360 KNX (Square)

Mounting height (A)	Walking (T)	Sitting (S)
2 m	36 m ² 6 m x 6 m ± 0,5 m	20 m ² 4,5 m x 4,5 m
2,5 m	64 m ² 8 m x 8 m ± 0,5 m	36 m ² 6 m x 6 m
3 m	81 m ² 9 m x 9 m ± 1 m	49 m ² 7 m x 7 m
3,5 m	100 m ² 10 m x 10 m ± 1 m	64 m ² 8 m x 8 m
6 m	144 m ² 12 m x 12 m ± 1,5 m	–
10 m	400 m ² 20 m x 20 m ± 2 m	–

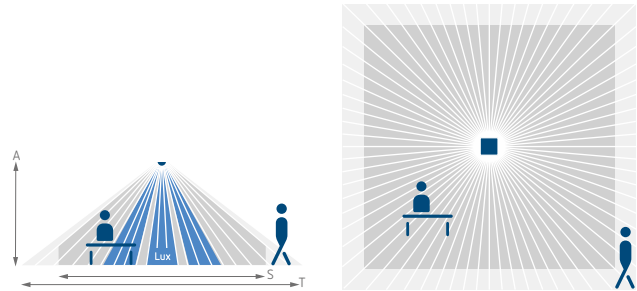

Detection range thePrema S360 KNX (Square)

Mounting height (A)	Walking (T)	Sitting (S)
2 m	20 m ² 4 m x 4 m ± 0,5 m	9 m ² 3 m x 3 m
2,5 m	36 m ² 6 m x 6 m ± 0,5 m	16 m ² 4 m x 4 m
3 m	49 m ² 7 m x 8 m ± 1 m	25 m ² 5 m x 5 m
3,5 m	64 m ² 8 m x 8 m ± 1 m	–

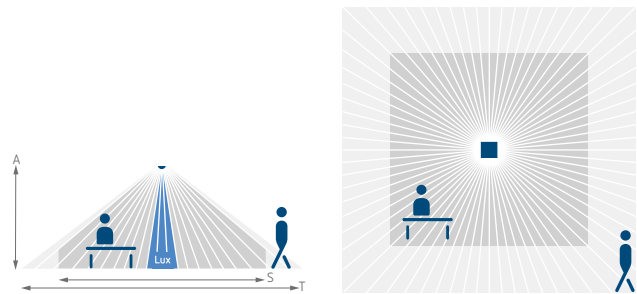

Accessories



Surface frame 110B WH
↳ Art.No.: 9070918
Details page 354



theSenda P
↳ Art.No.: 9070910
Details page 359



theSenda S
↳ Art.No.: 9070911
Details page 359

QuickSafe
Details page 355

theSenda B
Details page 359

Ceiling installation box 68A
Details page 354

Surface frame 110B GR
Details page 354

Scale drawings

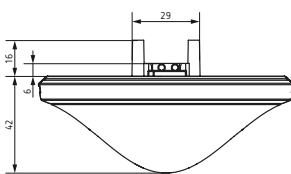

thePrema P360 KNX

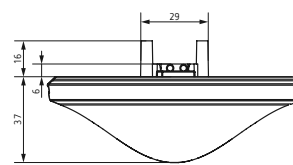
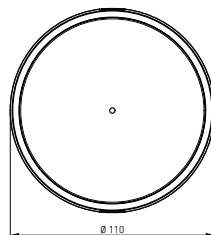

thePrema S360 KNX

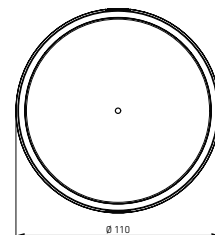

Home and building control

KNX, Presence detectors

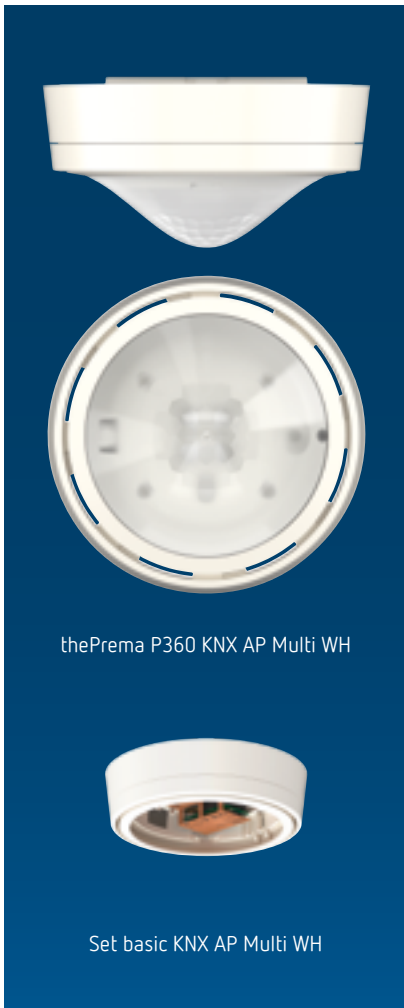

Description

- KNX multisensor
 - Consisting of KNX passive infrared presence detector and room air sensor (= 2 bus sharing units)
- Room air sensor functions**
- Measures CO₂ concentration, relative humidity, temperature and air pressure
 - Three independent, configurable thresholds for CO₂ concentration and relative humidity
 - Integrated room thermostat
 - 4 binary inputs
- Presence detector functions**
- Automatic presence and brightness-dependent control for lighting and HVAC
 - Square detection area 360°, up to 10 x 10 m (100 m²), for reliable and easy planning
 - 2 light channels C1, C2 with 2 light measurements and additional lighting channel C3 without influence of brightness
 - 2 presence channels C4, C5 can be programmed individually
 - Adaptable 3-channel light measurement
 - Mixed light measurement suitable for LEDs, fluorescent lamps (FL/PL/ESL), halogen and incandescent lamps
 - Operation as fully or semi-automatic device, switchable
 - Switching operation or constant light control with standby function (orientation light)
 - Lighting dimmable in switching mode with standby function
- Brightness switching value or set point value configurable in lux using parameters, object or remote control
 - Teach-in of the brightness switching value or set point value
 - Setting of the room correction factor for brightness measurement calibration
 - Light time delay configurable using parameters, object or remote control
 - Configurable switch-on delay and presence time delay
 - Configurable detection sensitivity
 - Self-learning time delay
 - Reduced time delay in the event of short presence
 - Room monitoring function with reduced sensitivity only for detection of walking persons
 - Scene functionality
 - Extremely simple adjustment of energy saving behaviour with "eco plus" function
 - Test mode for checking function and detection area
 - Parallel switching of multiple presence detectors (master/slave or master/master)
 - Room monitoring
 - Remote operation with the following remote controls:
 - theSenda B app remote control
 - theSenda P service remote control
 - theSenda S user remote control

Product selection

Product type	Type	Article number
KNX multisensor (complete device)	thePrema P360 KNX AP Multi WH	2079900
KNX multisensor retrofit set (room air sensor only) for combining with existing KNX detector thePrema S/P KNX UP WH	Set basic KNX AP Multi WH	9070900

Technical data

	thePrema P360 KNX AP Multi WH	Set basic KNX AP Multi WH
KNX operating voltage	Bus voltage, approx. 24 mA (28 mA with LED switched on)	Bus voltage, max. 15 mA
Installation height	2 – 10 m	
Brightness setting range	5 – 3000 lx, on	–
Lighting time delay	30 s – 60 min	–
Standby dimming value	1 – 25% of the lamp output	–
Standby time	30 s – 60 min / not active / permanently on	–
Presence time delay	10 s – 120 min	–
Presence switch-on delay	10 s – 30 min / not active	–
CO ₂ measurement range	300 – 5000 ppm	
Temperature measurement range	–5 °C to +45 °C	
Humidity measurement range	1 – 100% rh	
Air pressure	30,000 – 110,000 Pa	
Ambient temperature	5 °C to +40 °C	
Interface extension max.	30 m	
Protection rating	IP 20	

Detection area (square)

Installation height (A)	Seated (S)	Transverse (T)
2 m	20 m ² 4.5 x 4.5 m	36 m ² 6 x 6 m ± 0.5 m
2.5 m	36 m ² 6 x 6 m	64 m ² 8 x 8 m ± 0.5 m
3 m	49 m ² 7 x 7 m	81 m ² 9 x 9 m ± 1 m
3.5 m	64 m ² 8 x 8 m	100 m ² 10 x 10 m ± 1 m
6 m	–	144 m ² 12 x 12 m ± 1.5 m
10 m	–	400 m ² 20 x 20 m ± 2 m

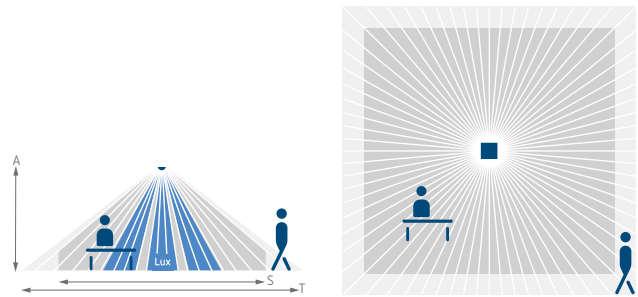

Accessories



theSenda P
↳ Art.No.: 9070910
Details page 359



theSenda S
↳ Art.No.: 9070911
Details page 359

QuickSafe
Details page 355

theSenda B
Details page 359

Ceiling installation box 68A
Details page 354

Scale drawings

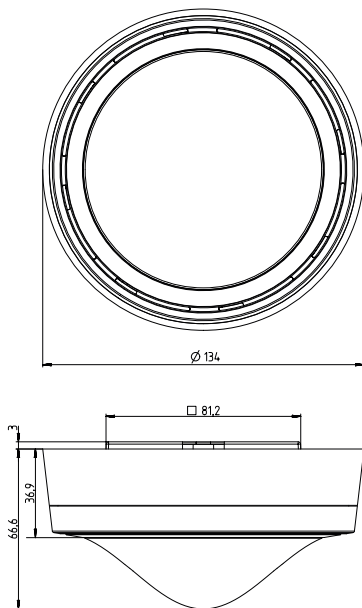

thePrema P360 KNX AP Multi WH

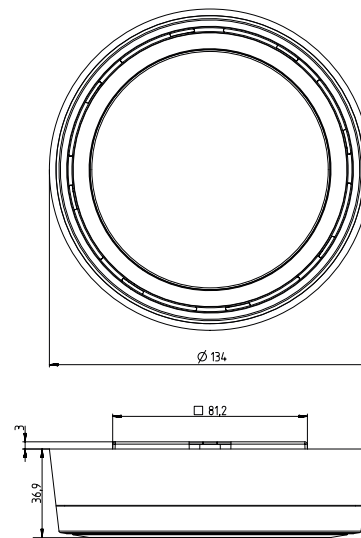

Set basic KNX AP Multi WH

Home and building control

KNX, Presence detectors



PlanoSpot 360 KNX DE WH

Description

PlanoSpot 360 KNX DE WH

- Passive infrared presence detector for ceiling installation
- Flat design, cover frame in white included in delivery
- Square detection area 360° (up to 64 m²) for reliable and easy planning
- Automatic presence- and brightness-dependent control for lighting and HVAC
- Two differently sized detection zones for greater flexibility. Adjustable via parameters or remote control.
- Manual alignment of the detection area (swivel mechanism)
- Mixed light measurement suitable for fluorescent lamps (FL/PL/ESL), halogen/ incandescent lamps and LEDs
- 3 directed light measurements
- 2 light channels C1, C2 with 2 light measurements and additional lighting channel C3 without brightness factor
- Switched or constant light control with 2 independent control systems and standby function (orientation light)
- Switching mode with dimmable lighting
- Fully or semi-automatic
- Brightness switching value or set point value can be set in lux by using parameters, the object or via remote control
- Teach-in of the brightness switching value or the set point value
- Light time delay configurable
- Self-learning time delay can be set using parameters, object or via remote control
- Reduction of time delay when present briefly (short-term presence)
- Manual override by telegram or remote control
- 2 presence channels C4, C5, individually configurable
- Switch-on delay and time delay configurable
- Room monitoring with selective movement detection
- Setting the room correction factor for brightness measurement comparison
- Configurable sensitivity
- Extremely simple setting of the energy-saving ratio with the new «eco plus» function
- Test mode for checking function and detection area
- Scenarios
- Parallel switching of multiple presence detectors (Master/Slave or Master/Master)
- Installation in false ceilings with springs
- Surface mounting on ceilings possible with surface frame (optional)
- User remote control «theSenda S» (optional)
- Management remote control «theSenda B» (optional)
- Installation remote control «theSenda P» (optional)

Product selection

Swivel mechanism	Colour	Type	Article number
√	Pure white (similar to RAL 9010)	PlanoSpot 360 KNX DE WH	2039100

Technical data

	PlanoSpot 360 KNX DE
Operating voltage KNX	Bus voltage, approx. 8 mA (9 mA LED on)
Installation height	2–3,5 m
Setting range brightness	approx. 10–3000 lx/measuring off
Light switch-off delay	30 s–60 min
Stand-by dimming value	1–25 % of the lamp output
Stand-by time	30 s–60 min/on/inactive
Presence switch-off delay	10 s–120 min
Presence switch-on delay	10 s–30 min/inactive
Ambient temperature	0 °C ... +50 °C
Type of protection	IP 40 (when fitted)

Detection range (Square)

Detection zone standard		
Mounting height (A)	Sitting (S)	Walking (T)
2 m	9 m ² 3 m x 3 m	20 m ² 4,5 m x 4,5 m ± 0,5 m
2,5 m	16 m ² 4 m x 4 m	36 m ² 6 m x 6 m ± 0,5 m
3 m	20 m ² 4,5 m x 4,5 m	49 m ² 7 m x 7 m ± 1 m
3,5 m	-	64 m ² 8 m x 8 m ± 1 m

Detection zone reduced		
Mounting height (A)	Sitting (S)	Walking (T)
2 m	4 m ² 2 m x 2 m	4,4 m ² 2,1 m x 2,1 m ± 0,5 m
2,5 m	6,3 m ² 2,5 m x 2,5 m	9 m ² 3 m x 3 m ± 0,5 m
3 m	9 m ² 3 m x 3 m	14,4 m ² 3,8 m x 3,8 m ± 1 m
3,5 m	-	22,1 m ² 4,7 m x 4,7 m ± 1 m

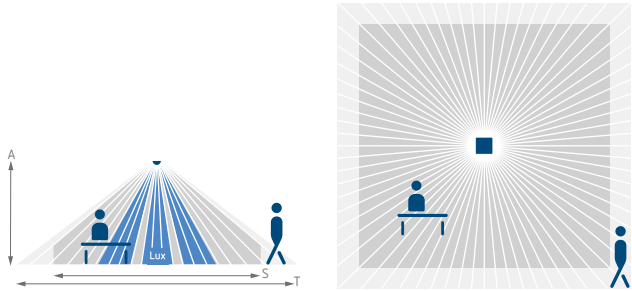

Accessories



theSenda B
↳ Art.No.: 9070985
Details page 359



theSenda P
↳ Art.No.: 9070910
Details page 359



theSenda S
↳ Art.No.: 9070911
Details page 359

- Surface frame 75B WH
Details page 355
- PlanoCover 76 BK
Details page 355
- PlanoCover 76 SR
Details page 355

Scale drawings

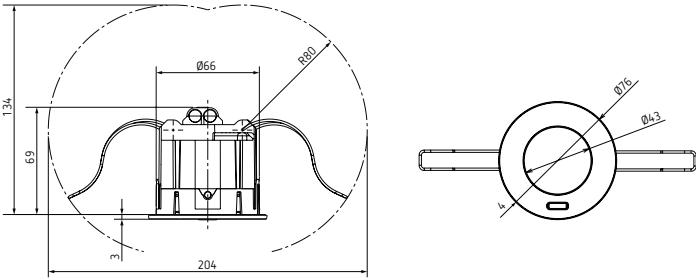

Home and building control

KNX, Presence detectors



Description

- KNX Passive infrared presence detector for ceiling mounting
- Round detection area 360°, up to Ø 24 m (452 m²)
- 2 channels light and 2 channels presence
- 2 channels light C1, C2 with 1 light measurement
- 2 presence channels can be parametrized individually
- Adaptable 1 channel light measurement
- Mixed light measurement suitable for LEDs, fluorescent lamps (FL/PL/ESL) and halogen/incandescent lamps
- Can be used as fully or semi-automatic, switchable
- Switch or constant light control mode with stand-by function
- Dimmable lighting in switch mode with stand-by function
- Brightness switching value or set point value can be set in lux using parameters, on the device itself or via remote control
- Teaching in of the brightness switching value or the set point value
- Room correction factor setting for brightness measurement calibration
- Light time delay can be set using parameters, on the device itself or via remote control
- Switch on delay and time delay for presence can be set
- Detection sensitivity can be set
- Reduced time delay in the event of a shorter stay in the room (short presence)
- Scenario functions
- Test mode for checking function and detection range
- Sensitivity adjustable
- Detection area can be limited using cover clip
- Manual override using telegram or remote control
- Parallel switching of several detectors in Master/Slave or Master/Master possible
- Ceiling installation in flush-mounted socket
- Ceiling installation also possible with surface-mounted frame
- User remote control and management-remote control (optional)

Product selection

Installation type	Colour	Type	Article number
Ceiling installation	White	theRonda P360 KNX UP WH	2089000

Technical data

	theRonda P360 KNX UP
Operating voltage KNX	Bus voltage, approx. 8 mA (9 mA LED on)
Installation height	2 – 15 m
Setting range brightness	10 – 3000 lx/measuring off
Light switch-off delay	30 s – 60 min
Stand-by dimming value	1 – 25 % of the lamp output
Stand-by time	30 s – 60 min/inactive/permanently on
Presence switch-off delay	10 s – 120 min
Presence switch-on delay	10 s – 30 min/inactive
Ambient temperature	– 15 °C ... +50 °C
Type of protection	IP 54 (when fitted)

Detection range (Round)

Mounting height (A)	Sitting (S)	Walking diagonally (T)	Walking head on to
2 m	16 m ² 4,5 m	380 m ² 22 m	28 m ² 6 m
2,5 m	24 m ² 5,5 m	415 m ² 23 m	38 m ² 7 m
3 m	28 m ² 6 m	452 m ² 24 m	50 m ² 8 m
3,5 m	38 m ² 7 m	452 m ² 24 m	50 m ² 8 m
6 m	-	452 m ² 24 m	50 m ² 8 m
10 m	-	491 m ² 25 m	50 m ² 8 m

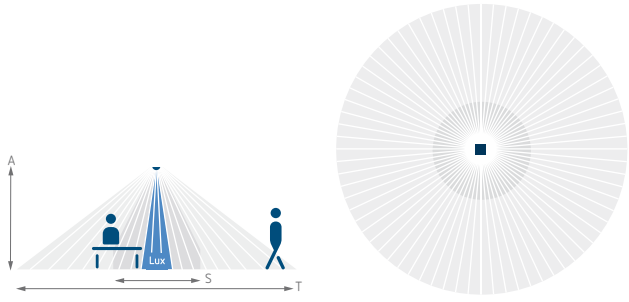

Accessories



Surface frame 110A WH
↳ Art.No.: 9070912
Details page 354



theSenda P
↳ Art.No.: 9070910
Details page 359



theSenda S
↳ Art.No.: 9070911
Details page 359

QuickSafe
Details page 355

theSenda B
Details page 359

Surface frame 110A GR
Details page 354

Ceiling installation box 68A
Details page 354

Masking clip
Details page 355

Cover 110 GR
Details page 355

Scale drawings

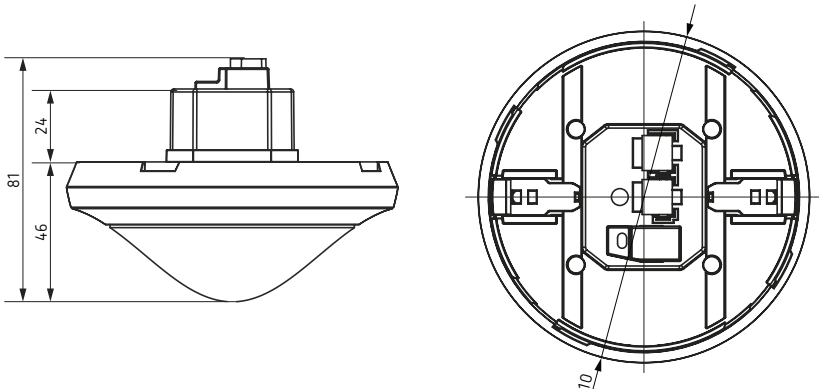

Home and building control

KNX, Presence detectors



Description

- KNX Passive infrared presence detector for ceiling installation
- Circular detection area 360°, up to Ø 9 m (64 m²)
- Automatic presence- and brightness-dependent control for lighting and HVAC
- Mixed light measurement suitable for fluorescent (FL/PL/ESL), halogen/ incandescent lamps and LEDs
- 2 light channels C1, C2
- Switching operation or constant light control with standby function (orientation light)
- Switching mode with dimmable lighting
- Choice of fully or semi-automatic
- Brightness switching value or set point value can be set in lux by using parameters, the object or via remote control
- Teach-in of the brightness switching value or the set point value
- Reduction of time delay when present briefly (short-term presence)
- Manual override by telegram or remote control
- 2 presence channels C4, C5, individually configurable
- Switch-on delay and time delay configurable
- Setting the room correction factor for brightness measurement comparison
- Adjustable sensitivity
- Test mode for checking function and detection area
- Scenes
- Parallel switching of multiple presence detectors (Master/Slave or Master/Master)
- User remote control «theSenda S» (option)
- Management remote control «theSenda B» (option)
- Installation remote control «theSenda P» (option)

Product selection

Installation type	Colour	Type	Article number
Ceiling installation	White	theRonda S360 KNX AP WH	2089550
	Grey	theRonda S360 KNX AP GR	2089551
	White	theRonda S360 KNX FLAT DE WH	2089560

Technical data

	theRonda S360 KNX AP	theRonda S360 KNX FLAT DE
Operating voltage KNX	Bus voltage, 9 mA	
Installation height	2–4 m	
Setting range brightness	approx. 30–3000 lx/measuring off	
Light switch-off delay	30 s–60 min	
Presence switch-off delay	10 s–120 min	
Presence switch-on delay	10 s–30 min/inactive	
Ambient temperature	–15 °C ... +50 °C	
Type of protection	IP 54 (when fitted)	

Detection range (Round)

Mounting height (A)	Sitting (S)	Walking (T)
2 m	5 m ² 2,5 m	38 m ² 7 m
2,5 m	7 m ² 3 m	38 m ² 7 m
3 m	13 m ² 4 m	50 m ² 8 m
3,5 m	-	50 m ² 8 m
4 m	-	64 m ² 9 m

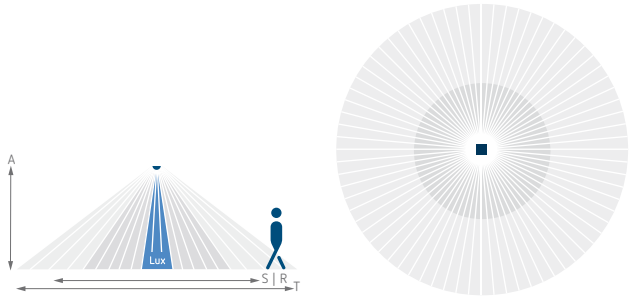

Accessories



theSenda B
↳ Art.No.: 9070985
Details page 359



theSenda P
↳ Art.No.: 9070910
Details page 359

theSenda S
Details page 359
Cover 85 FLAT GR
Details page 355

Scale drawings

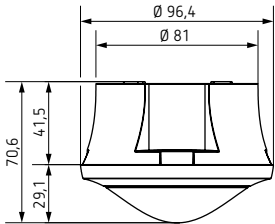

theRonda S360 KNX AP

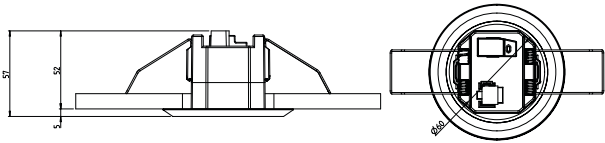
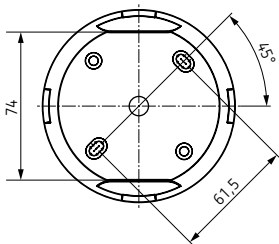

theRonda S360 KNX FLAT DE



Description

- KNX Passive infrared presence detector for ceiling mounting
- Square detection area for corridors and storage areas
- Detection area with 2 individually connectable and disconnectable detection zones, each 15 x 5 m (total 30 x 5 m)
- 2 channel light and 2 channel presence
- 2 channel light C1, C2 with 2 light measurements
- 2 presence channels can be parametrized individually
- Adaptable 2 channel light measurement
- Function aura effect, switches on the lighting group when there is a person in its detection area and dims the adjacent lighting groups
- Function chaser light, recognises the direction of movement of the people in the room and „predictively“ switches on the adjacent lighting group
- Function walking direction recognition
- Mixed light measurement suitable for LEDs, fluorescent lamps (FL/PL/ESL) and halogen/incandescent lamps
- Can be used as fully or semi-automatic, switchable
- Switch or constant light control mode with stand-by function
- Dimmable lighting in switch mode with stand-by function
- Brightness switching value or set point value can be set in lux using parameters, on the device itself or via remote control
- Teaching in of the brightness switching value or the set point value
- Room correction factor setting for brightness measurement calibration
- Light time delay can be set using parameters, on the device itself or via remote control
- Switch on delay and time delay for presence can be set
- Detection sensitivity can be set
- Reduced time delay in the event of a shorter stay in the room (short presence)
- Scenario functions
- Test mode for checking function and detection range
- Sensitivity adjustable
- Detection area can be limited using cover clip
- Manual override using telegram or remote control
- Parallel switching of several detectors in Master/Slave or Master/Master possible
- Ceiling installation in flush-mounted socket
- Ceiling installation also possible with surface-mounted frame
- User remote control and management-remote control (optional)

Product selection

Installation type	Colour	Type	Article number
Ceiling installation	White	thePassa P360 KNX UP WH	2019300

Technical data

	thePassa P360 KNX UP WH
Operating voltage KNX	Bus voltage, ca. 9 mA
Installation height	2 – 15 m
Minimum height	> 1,7 m
Setting range brightness	10–3000 lx
Light switch-off delay	30 s–60 min
Presence switch-off delay	10 s–120 min
Switch-on delay presence	10 s–30 min / inactive
Ambient temperature	–15 °C ... +50 °C
Type of protection	IP 54 (when fitted)

Detection range (Rectangular)

Mounting height (A)	Head on to (r)	Diagonally (t)
2 m	56 m ² 16 m x 3,5 m	56 m ² 16 m x 3,5 m
2,5 m	72 m ² 18 m x 4 m	88 m ² 22 m x 4 m
3 m	90 m ² 20 m x 4,5 m	135 m ² 30 m x 4,5 m
3,5 m	100 m ² 20 m x 5 m	150 m ² 30 m x 5 m
4 m	100 m ² 20 m x 5 m	150 m ² 30 m x 5 m
4,5 m	100 m ² 20 m x 5 m	150 m ² 30 m x 5 m
5 m	100 m ² 20 m x 5 m	150 m ² 30 m x 5 m
5,5 m	100 m ² 20 m x 5 m	150 m ² 30 m x 5 m
6 m	100 m ² 20 m x 5 m	150 m ² 30 m x 5 m

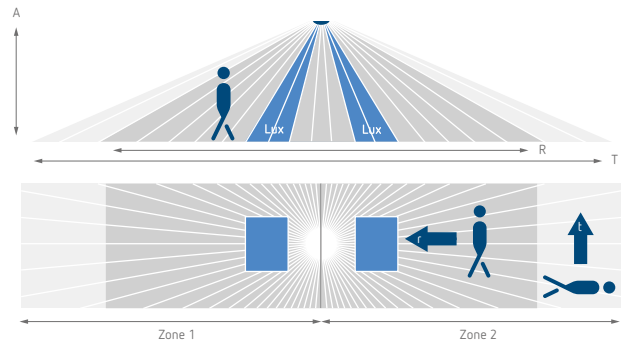

Accessories



Surface frame 110A WH

↳ Art.No.: 9070912

Details page 354



theSenda P

↳ Art.No.: 9070910

Details page 359



theSenda S

↳ Art.No.: 9070911

Details page 359

QuickSafe

Details page 355

theSenda B

Details page 359

Surface frame 110A GR

Details page 354

Ceiling installation box 68A

Details page 354

Masking clip

Details page 355

Cover 110 GR

Details page 355

Scale drawings

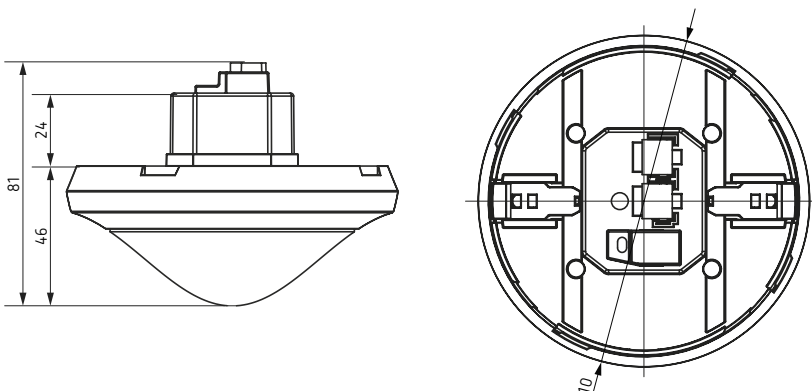

Home and building control

KNX, Presence detectors



Description

- Presence detector (PIR)
- Automatic control of lighting depending on presence and brightness
- Square detection area allows accurate and simple planning
- IP 54 for versatile use
- 2 channels light for controlling one or two lighting groups
- Mixed light measurement, suitable for fluorescent lamps (FL/PL/ESL), halogen/ incandescent lamps and LEDs
- Switching or constant light control with stand-by function
- Adjustable sensitivity
- Choice of fully or semi automatic operation: In „Semi-automatic“ mode the light must be switched on manually and switches off automatically
- Short presence; Reduced switch-off delay time in case of a short presence
- Self-learning time delay
- Channel presence with switch-off delay and switch-on delay time and send values
- Function „monitoring“ with reduced sensitivity only to detect walking persons
- Channel brightness (Lux)
- Set brightness level via bus object
- Scene functionality (8-bit scenes)
- Selected parameters can be configured remotely using the theSendä B remote control. Parameter settings are made via ETS
- Optional user remote control
- Ready for use by ex-factory set items
- Test operation to check detection area and installation
- Parallel switching of several presence detectors (master-slave or master-master) possible
- Ceiling mounting in flush-mounted box
- Possibility of surface mounting by using a surface frame

Product selection

Installation type	Colour	Type	Article number
Ceiling installation	Pure white (similar to RAL 9010)	PresenceLight 360B-KNX WH	2009000

Technical data

	PresenceLight 360B-KNX
Operating voltage KNX	Bus voltage, approx. 13 mA (17 mA LED on)
Installation height	2–3,5 m
Setting range brightness	approx. 5–2000 lx/measuring off
Light switch-off delay	30 s–60 min
Stand-by time	30 s–60 min, on, inactive
Presence switch-off delay	10 s–120 min
Presence switch-on delay	10 s–30 min/inactive
Ambient temperature	–10 °C ... +50 °C
Type of protection	IP 54

Detection range (Square)

Mounting height (A)	Walking (T)	Sitting (S)
2 m	20 m ² 4,5 m x 4,5 m ± 0,5 m	9 m ² 3 m x 3 m
2,5 m	36 m ² 6 m x 6 m ± 0,5 m	16 m ² 4 m x 4 m
3 m	49 m ² 7 m x 7 m ± 1 m	20 m ² 4,5 m x 4,5 m
3,5 m	64 m ² 8 m x 8 m ± 1 m	–

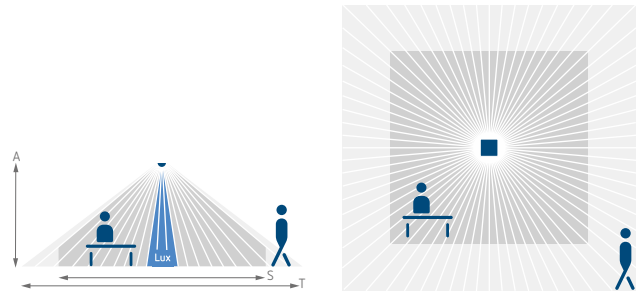

Accessories



Surface frame PresenceLight

↳ Art.No.: 9070513
Details page 354



theSenda B

↳ Art.No.: 9070985
Details page 359



QuickSafe

↳ Art.No.: 9070531
Details page 355



theSenda P

↳ Art.No.: 9070910
Details page 359



theSenda S

↳ Art.No.: 9070911
Details page 359

Cover frame PresenceLight 360 SR
Details page 354

Cover frame PresenceLight 360 BK
Details page 3554

Surface frame PresenceLight BK
Details page 354

Surface frame PresenceLight SR
Details page 354

Scale drawings

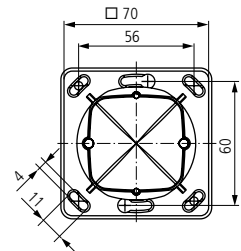
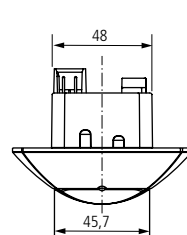
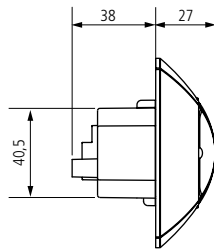
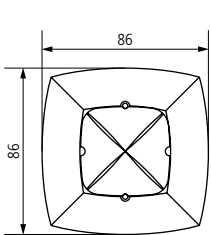

Home and building control

KNX, Presence detectors

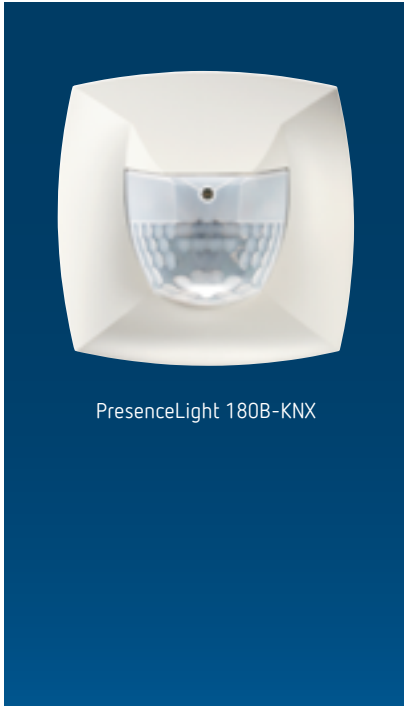

Description

- Presence detector (PIR)
- Automatic control of lighting depending on presence and brightness
- IP 54 for versatile use
- 2 channels light for controlling one or two lighting groups
- Mixed light measurement, suitable for fluorescent lamps (FL/PL/ESL), halogen/ incandescent lamps and LEDs
- Switching or constant light control with stand-by function
- Adjustable sensitivity
- Choice of fully or semi automatic operation: In „Semi-automatic“ mode the light must be switched on manually and switches off automatically
- Short presence; Reduced switch-off delay time in case of a short presence
- Channel presence with switch-off delay and switch-on delay time and send values
- Function „monitoring“ with reduced sensitivity only to detect walking persons
- Channel brightness (Lux)
- Set brightness level via bus object
- Scene functionality (8-bit scenes)
- Selected parameters can be configured remotely using the theSenda B remote control. Parameter settings are made via ETS
- Optional user remote control
- Ready for use by ex-factory set items
- Test operation to check detection area and installation
- Parallel switching of several presence detectors (master-slave or master-master) possible
- Wall mounting in flush-mounted box
- Possibility of surface mounting by using a surface frame

Product selection

Installation type	Colour	Type	Article number
Wall installation	Pure white (similar to RAL 9010)	PresenceLight 180B-KNX WH	2009050

Technical data

	PresenceLight 180B-KNX
Operating voltage KNX	Bus voltage, approx. 13 mA (17 mA LED on)
Installation height	1,7–2,2 m
Setting range brightness	approx. 5–2000 lx/measuring off
Light switch-off delay	30 s–60 min
Stand-by dimming value	5–10 %
Stand-by time	30 s–60 min/on/inactive
Presence switch-off delay	10 s–120 min
Presence switch-on delay	10 s–30 min/inactive
Ambient temperature	–10 °C ... +50 °C
Type of protection	IP 54

Detection range (Semicircular)

Mounting height (A)	Walking (T)	Sitting (S)
2,2 m	100 m ² 8 m	25 m ² 7 m x 3,5 m

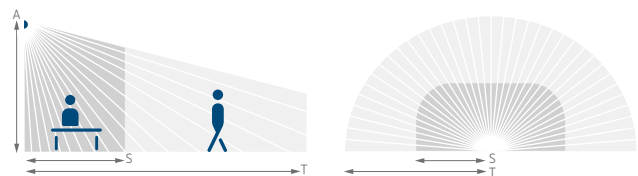



Accessories



Surface frame PresenceLight
↳ Art.No.: 9070513
Details page 354



theSenda B
↳ Art.No.: 9070985
Details page 359



QuickSafe
↳ Art.No.: 9070531
Details page 355



theSenda P
↳ Art.No.: 9070910
Details page 359



theSenda S
↳ Art.No.: 9070911
Details page 359

Cover frame PresenceLight 180 SR
Details page 354

Cover frame PresenceLight 180 BK
Details page 354

Surface frame PresenceLight BK
Details page 354

Surface frame PresenceLight SR
Details page 354

Scale drawings

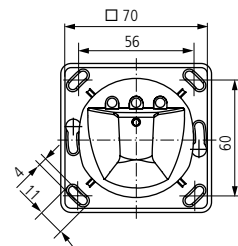
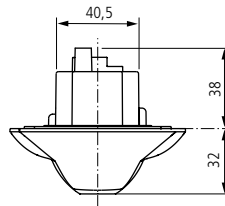
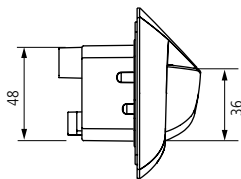
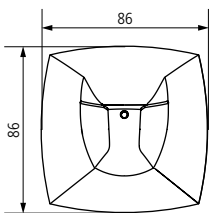

Home and building control

KNX, Motion detectors



Description

- Motion detector (PIR)
- Automatic lighting control based on presence and brightness
- For integration into KNX building systems
- For outdoor use
- For installation on walls and ceilings
- Integrated temperature sensor
- For larger, commercial outdoor applications such as offices, public buildings, hotels, schools, car parks and warehouses
- Easy to program with KNX ETS software
- Adjustable brightness switching value and switch-off delay
- Sensitivity can be reduced
- Area limit via lens attachment
- Mixed light measurement
- Teach-in of current brightness value possible
- Pulse function
- Test function for checking detection area
- Installation on flush-mounted socket possible (60 mm)
- Single-handed plug-in installation
- Instant start-up possible via factory preset
- Controls are place protected
- Spacer and corner angle included

Product selection

Installation type	Colour	Type	Article number
Wall and ceiling installation	White	theLuxa P300 KNX WH	1019610
	Black	theLuxa P300 KNX BK	1019611

Technical data

	theLuxa P300 KNX
Operating voltage KNX	Bus voltage, < 10 mA
Setting range brightness	1 – 3000 lx
Light switch-off delay	1 s – 60 min
Ambient temperature	-25 °C ... +45 °C
Protection class	III
Type of protection	IP 55

Detection range

Mounting height	Head on to	Diagonally
2 m	4 m	12 m
2,5 m	5 m	16 m
3 m	5 m	16 m
3,5 m	5 m	16 m
4 m	4 m	12 m

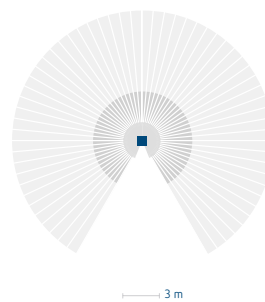

- Walking diagonally to the detector
 - Walking head on to the detector
 - Creep under protection
- Mounting height: 2,5 m



Accessories



Corner angle theLuxa P WH
↳ Art.No.: 9070904
Details page 356



Corner angle theLuxa P BK
↳ Art.No.: 9070905
Details page 356



theSenda P
↳ Art.No.: 9070910
Details page 359



Spacer theLuxa P WH
↳ Art.No.: 9070908
Details page 356



Spacer theLuxa P BK
↳ Art.No.: 9070909
Details page 356



theSenda S
↳ Art.No.: 9070911
Details page 359

Scale drawings

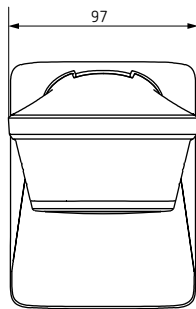
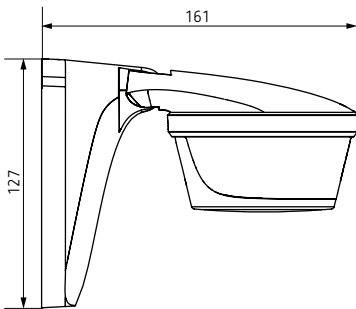



Description

IPsecure Interface KNX

- Interface IP and KNX
- For data exchange between KNX and IP networks
- Support of KNX IP Secure
- Meets the requirements of the KNXnet / IP standard
- Tunneling: Up to 5 Tunneling Server
- Firmware update possible (Theben IP Tool Software)
- Power supply: 12–30 V DC / PoE - IEEE 802.3af class 1

IPsecure Router KNX

- Router / interface / line coupler IP and KNX
- For data exchange between KNX and IP networks
- Support of KNX IP Secure
- Meets the requirements of the KNXnet / IP standard
- Complete filter table for all main groups (0... 31)
- Display of power failures on the bus (KNX IP Service)

- Unicast: Up to 10 devices can communicate via unicast
- Tunneling: 5 tunneling servers available (visualization, app ...)
- Firmware update possible (Theben IP Tool Software)
- Power supply: 12–30 V DC / PoE - IEEE 802.3af class 1

Product selection

Type	Article number
IPsecure Interface KNX	9070771
IPsecure Router KNX	9070770

Technical data

	IPsecure Interface KNX	IPsecure Router KNX
Operating voltage KNX	Bus voltage, ≤10 mA	
Operating voltage	12–30 V DC	
Width	2 modules	
Ambient temperature	-5 °C ... +45 °C	
Protection class	II according to EN 60 730-1	
Type of protection	IP 20	



Description

Interface USB KNX

- For communication between the PC and the KNX system to be programmed
- Fast download of applications by supporting long frames (from ETS 5)
- Support of KNX Data Secure communication

Line coupler S KNX

- For the connection of KNX lines or areas
- Galvanic separation of the lines / areas
- Long frame support (from ETS 5)
- Support of KNX Data Secure communication
- Telegrams can be forwarded, filtered or blocked
- Can also be used as a line amplifier (repeater)

Product selection

Type	Article number
Interface USB KNX	9070397
Line coupler S KNX	9070880

Technical data

	Interface USB KNX	Line coupler S KNX
Operating voltage KNX	Bus voltage, ≤10 mA	
Operating voltage	-	24 V DC
Width	2 modules	
Ambient temperature	-5 °C ... +45 °C	
Protection class	II according to EN 60 730-1	III
Type of protection	IP 20	



PS 160 mA T KNX

PS 320 mA T KNX

PS 640 mA T KNX

Description

Common functions

- 30 V DC auxiliary supply
- Power-supplying and monitoring of the KNX system voltage
- Reset key for 20 sec. bus reset

- Continuous short-circuit protection

PS 160 mA T KNX

160 mA supply voltage

- 320 mA supply voltage

PS 640 mA T KNX

- 640 mA supply voltage

Product selection

Type	Article number
PS 160 mA T KNX	9070956
PS 320 mA T KNX	9070957
PS 640 mA T KNX	9070958

Technical data

	PS 160 mA T KNX	PS 320 mA T KNX	PS 640 mA T KNX
Operating voltage KNX	Bus voltage, ≤ 12 mA		
Operating voltage	230–240 V AC		
Frequency	50–60 Hz		
Stand-by consumption	$\leq 0,8$ W		
Width	4 modules		
KNX output	1 line with integrated throttle drive		
Nominal voltage KNX	30 V DC, ± 2 V, SELV		
Nominal current KNX	160 mA	320 mA	640 mA
Uninterrupted short-circuit current	max.0,5 A	max.0,8 A	max.1,4 A
Mains failure bridging time	min.130 ms		
Ambient temperature	-5 °C ... +45 °C		
Protection class	II according to EN 60 730-1		
Type of protection	IP 20		



Description

KNX Set 1 FIX

Consisting of:

- PS 640 mA T KNX
- DM 4-2 T KNX
- TA 4 S KNX

KNX Set 2 FIX

Consisting of:

- PS 640 mA T KNX
- DM 8-2 T KNX
- RM 8 T KNX
- TA 8 S KNX
- 2 x TA 4 S KNX

KNX Set 3 MIX

Consisting of:

- PS 640 mA T KNX
- RMG 8 T KNX
- 2 x DME 2 T KNX
- 2 x TA 4 S KNX

KNX Set 4 KNX-RF

Consisting of:

- PS 640 mA T KNX
- TP-RF KNX
- SU 1 RF KNX
- JU 1 RF KNX
- DU 1 RF KNX

Product selection

Type	Article number
KNX Set 1 FIX	4990201
KNX Set 2 FIX	4990202
KNX Set 3 MIX	4990203
KNX Set 4 KNX-RF	4990204

Home and building control

KNX, HVAC controller



Description

- Multi-functional display with room thermostat
- Glass front in white
- Freely configurable for displaying and controlling functions e.g. light settings, sun protection systems
- Backlit display and integrated time switch
- For control and regulation of heating, fan coils, air conditioning systems
- Up to 7 different display pages
- Automatic summer/winter time adjustment with power reserve
- Controls up to 8 rooms via own temperature profiles
- Weekly time switch with 8 channels with up to 3 different statuses, e.g. for light, shutters, fans etc.
- 3 heating programs
- Alternative continuous or on/off control
- Operation modes: comfort, stand-by, temperature reduction at night, frost protection
- Weather data from Theben weather stations can be displayed
- Free choice of programming via the ETS without plug-in
- Installation in flush-mounted socket

Product selection

Colour	Type	Article number
Glass front in white	VARIA 826 S WH KNX	8269210

Technical data

	VARIA 826 S WH KNX
Operating voltage KNX	Bus voltage, ≤15 mA, (<25 mA without power supply)
Operating voltage	230 V AC
Frequency	50 Hz
Stand-by consumption	0,4 W
Power reserve	1,5 years
Display	Display with 132 x 72 points (8 lines with various functions) e.g. title, switching, dimming, blinds/shutters, % value, HVAC, counter value, temperature, 2-byte value, 8/16 bit counter value etc.
Ambient temperature	0 °C ... +45 °C
Type of protection	IP 20
Protection class	II according to EN 60 730-1

Scale drawings

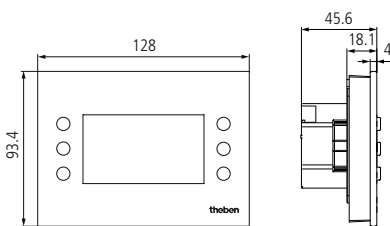



KNX-OT-Box S

Description

- The KNT-OT-Box S serves as an interface between the boilers with OpenTherm (bus system in heating and ventilation technology) and the KNX system (building system technology)
- This enables the bidirectional exchange of data between the OpenTherm boiler and the heat distribution via the KNX system (individual room control)
- In combination with the OT-Box (9070712) from the RAMSES 856 top2 OT (8569132) also heating systems without OpenTherm interface can be controlled
- Device and KNX bus module can be swapped independently of each other
- Removable KNX bus module
- Button for OT-test-program
- The following functions are available with the KNT- OT-box:
 - Customised flow control
 - Weather-compensation flow control
 - Control of domestic hot water
 - Energy optimization of domestic hot water with solar support
 - Legionella protection program
 - Screed drying program

Product selection

Type	Article number
KNX-OT-Box S	8559201

Technical data

KNX-OT-Box S			
Operating voltage KNX	Bus voltage, ≤10 mA	Ambient temperature	+0 °C ... +45 °C
Width	4 modules	Protection class	III
Rated impulse with stand voltage	4 kV	Type of protection	IP 20

Connection diagrams

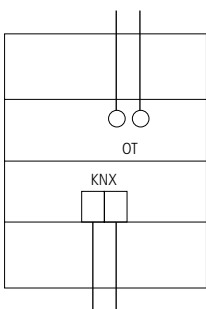

KNX-OT-Box S

Home and building control

KNX, HVAC controller



RAMSES 718 P KNX

Description

- Individual room thermostat
- For controlling heating actuators or motorised actuators
- Can be used as a continuous or two point control (can also be combined).
- Continuous PI control can be configured for 2 stage heating (basic and additional stage, e. g. underfloor heating and radiators) or for heating and cooling (radiators and cooling surfaces)
- Two front panels are included in delivery: a numerical scale and a relative scale
- Rotary control can be limited via parameters
- Manual override button for presence or operation modes: comfort, stand-by, temperature reduction at night, frost protection
- 4 binary inputs for conventional switches/sensors (switching, dimming, blinds), also for external temperature sensor, window contact or presence signal
- Temperature sensor can be connected to give remote temperature reading
- LED (red) for heating mode, (blue) for cooling mode, LEDs for operation mode

Product selection

Type	Article number
RAMSES 718 P KNX	7189210

Technical data

RAMSES 718 P KNX			
Operating voltage KNX	Bus voltage, ≤ 12 mA	Setting range temperature	+10 °C ... +30 °C
Interface extension max.	30 m	Type of protection	IP 20
Ambient temperature	+5 °C ... +40 °C	Protection class	III according to EN 60 730-1
Measuring range temperature	-5 °C ... +45 °C		

Accessories

Flush-mounted temperature sensor

Details page 361

Temperature sensor

Details page 361

Temperature sensor RAMSES IP 65

Details page 361

Scale drawings

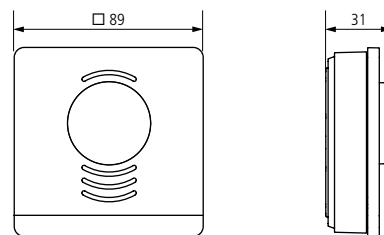

RAMSES 718 P KNX



RAMSES 718 S KNX

Description

- Individual room thermostat
- For controlling heating actuators or motorised actuators
- Can be used as a continuous or two point control (can also be combined)
- Temperature sensor can be connected to give remote temperature reading
- Objects for night operation (only with „old“ operation mode selection) presence, window/frost
- LED (red) for heating mode, (blue) for cooling mode
- 4 binary inputs for conventional switches/sensors (switch/sensor, dimmer, blinds, valuator, LED control)

Product selection

Type	Article number
RAMSES 718 S KNX	7189200

Technical data

RAMSES 718 S KNX			
Operating voltage KNX	Bus voltage, ≤12 mA	Setting range temperature	+10 °C ... +30 °C
Interface extension max.	30 m	Type of protection	IP 20
Ambient temperature	+5 °C ... +40 °C	Protection class	III according to EN 60 730-1
Measuring range temperature	-5 °C ... +45 °C		

Accessories

Flush-mounted temperature sensor

Details page 361

Temperature sensor

Details page 361

Temperature sensor RAMSES IP 65

Details page 361

Scale drawings

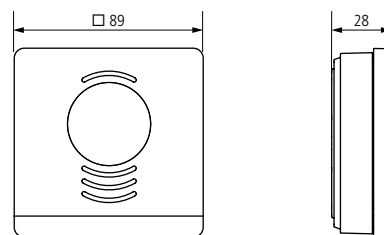

RAMSES 718 S KNX

Home and building control

KNX, HVAC controller



HMG 6 T KNX

HME 6 T KNX

HM 12 T KNX

Description

Common functions

- Heating actuator
- Short-circuit-proof and overcharge protected
- Continuous or switching actuating value selectable
- Valve protection function can be deactivated
- With the modes: comfort, standby, night as well as frost/heating protection
- Changeover to summer mode possible
- LED switching status display for each channel
- Manual operation on device (even without bus connection)

HMG 6 T KNX

- 6-way heating actuator MIX2
- With 6 temperature controllers (P/PI) for heating and cooling
- Base module MIX2
- Can be upgraded to maximum of 18 channels
- For controlling 6 thermal actuators 24 V–240 V AC in 2 groups with 3 outputs and 450 mA each
- Up to two extension modules MIX or MIX2 can be connected to one base module
- Device and KNX bus module can be swapped independently of each other
- Removable KNX bus module enables devices to be changed without reprogramming
- Manual set-up and use of actuator is possible without KNX bus module

HME 6 T KNX

- 6-way heating actuator MIX2
- With 6 temperature controllers (P/PI) for heating and cooling
- Extension module MIX2
- For upgrading to maximum of 18 channels

HM 6 T KNX

- 6-way heating actuator FIX1
- With 6 temperature controllers (P/PI) for heating and cooling
- For controlling 6 thermal actuators 24 V–240 V AC in 2 groups with 3 outputs and 450 mA each

HM 12 T KNX

- 12-way heating actuator FIX2
- With 12 temperature controllers (P/PI) for heating and cooling
- For controlling 12 thermal actuators 24 V–240 V AC in 4 groups with 3 outputs and 450 mA each

Product selection

Function	Type	Article number
MIX2 Base module	HMG 6 T KNX	4930240
MIX2 Extension module	HME 6 T KNX	4930245
FIX1 module	HM 6 T KNX	4940240
FIX2 module	HM 12 T KNX	4940245



Technical data

	HMG 6 T KNX	HME 6 T KNX	HM 12 T KNX	HM 6 T KNX
Operating voltage KNX	Bus voltage, ≤ 4 mA	–	Bus voltage, ≤ 12 mA	Bus voltage, ≤ 4 mA
Operating voltage	110–240 V AC	–	110–240 V AC	
Frequency	50–60 Hz	–	50–60 Hz	
Stand-by consumption	0,3 W	0,2 W	0,5 W	0,3 W
Width	4 modules		8 modules	4 modules
Max. cable cross section	Solid wire: 0.5 mm ² to 6 mm ² Stranded wire with end sleeve: 0.5 mm ² to 4 mm ²			
Switching output	Not potential-free			
Output	Triac, 0,45 A			
Ambient temperature	–5 °C ... +45 °C			
Type of protection	IP 20			
Protection class	II according to EN 60 669			

Accessories



Actuator ALPHA 5 230 V

↳ Art.No.: 9070441

Details page 362



Actuator ALPHA 5 24 V

↳ Art.No.: 9070442

Details page 362

Connection diagrams

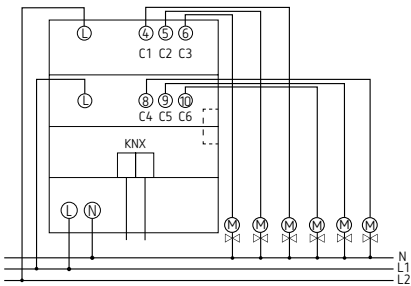

HMG 6 T KNX, HM 6 T KNX

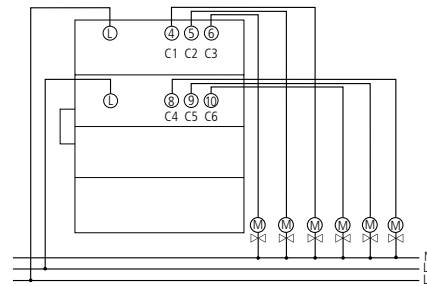

HME 6 T KNX

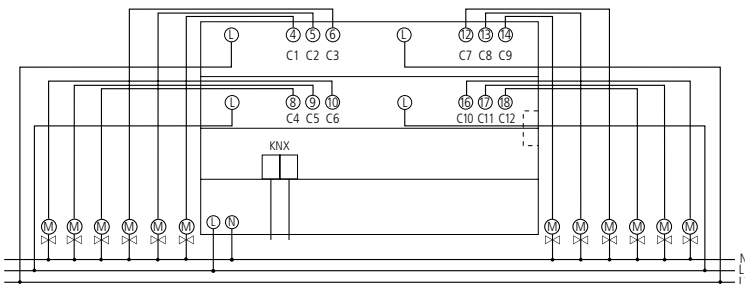

HM 12 TKNX

Home and building control

KNX, HVAC controller



Description

- Heating actuator for controlling thermal actuators, switching 24 V DC or permanently 0–10 V DC
 - Integration of up to 2 heating circuit pumps
 - Flow temperature adjustment to meet requirements: Automatic calculation of the maximum actuating value for energy-efficient adjustment of the actuating value to actual requirements
 - No KNX room thermostat needed: Flexible use of each channel as a heating actuator or heating controller
 - Can be installed directly on a rail in the heating circuit distributor
 - Screwless terminal technology
 - Integrated power supply for a maximum of 12 thermal actuators
 - Silent semiconductor switch (triac)
 - For integrating boiler control
 - Continuous or switching actuating value selectable
- HMT 6 KNX**
- 6-way
- HMT 12 KNX**
- 12-way

Product selection

Type	Article number
HMT 6 S KNX	4900373
HMT 12 S KNX	4900373

Technical data

	HMT 6 S KNX	HMT 12 S KNX
Operating voltage KNX	Bus voltage, ≤ 10 mA	
Operating voltage	230–240 V AC	
Stand-by consumption	< 1 W	
Frequency	50–60 Hz	
Number of channels	6	12
Switching capacity	Valve output: 24 V SELV; 0.4 A peak; 0.12 A permanent or 0–10 V at at least 1250 ohm 24 V output terminal: max. 1.4 A	
Switch output	5 A, 240 V AC floating (pump)	
Ambient temperature	-5 °C ... +50 °C	
Type of protection	IP 20	
Protection class	II according to EN 60 730-1	

Accessories



Actuator ALPHA 5 24 V
 ↳ Art.No.: 9070442
 Details page 362

Scale drawings

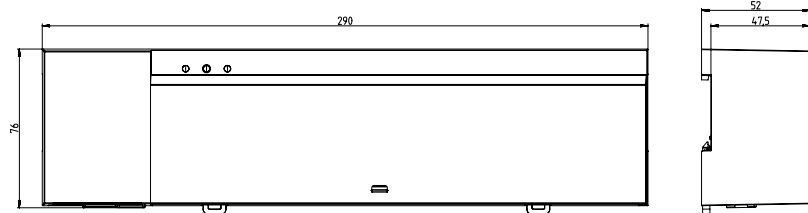

HMT 6 S KNX, HMT 12 S KNX

Connection diagrams

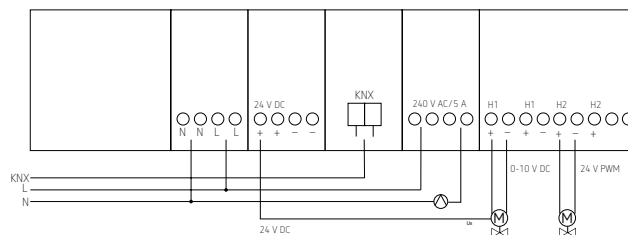

HMT 6 S KNX



CHEOPS control KNX

CHEOPS drive KNX

Description

Common functions

- Motorised actuator for heater valve or for controlling the heating valves
- Display of valve stroke
- Automatic valve stroke recognition
- 2 inputs for window contact, presence detector, remote sensor (remote sensor only for CHEOPS control and only 9070191)
- Simple installation by clicking onto valve adapter
- Can be used in heating circuit distributor

- Integrated bus coupling unit
- With summer mode and valve protection
- 2 different valve adapters included (VA 10, VA 78)

CHEOPS control KNX

- Independent room thermostat and integrated temperature sensor
- Manual operation possible via 2 keys on the device
- Display via LEDs (red/blue for hotter/colder)
- Configurable as: Heating control (continuous control), two stage heating, heating and cooling

CHEOPS drive KNX

- Without integrated control
- Display via LEDs (red)

Product selection

Type	Article number
CHEOPS control KNX	7329201
CHEOPS drive KNX	7319200

Technical data

	CHEOPS control KNX	CHEOPS drive KNX
Operating voltage KNX	Bus voltage, ≤ 10 mA	
Max. valve stroke	7,5 mm	
Controlling torque details	120 N	
Ambient temperature	0 °C ... +50 °C	
Dimensions	50 mm, 82 mm, 65 mm	
Protection class	III according to EN 60730-2-14	
Type of protection	IP 20	IP 21

Accessories

External temperature sensor 1

Details page 360

Valve adapter VA 80

Details page 362

Scale drawings

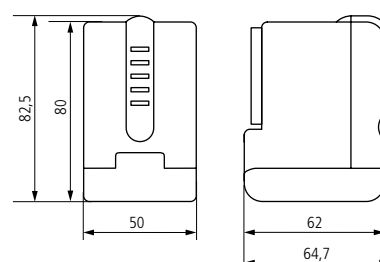

Home and building control

KNX, HVAC controller



AMUN 716 S KNX

Description

- CO₂ airquality sensor with integrated individual room thermostat
- Measures CO₂ level, relative humidity, temperature and barometric air pressure
- Three independent, configurable thresholds for the CO₂ level and relative humidity
- CO₂ setting range of 300-5000 ppm
- Actions can be carried out if thresholds are exceeded or not reached (send, priority, switching, value)
- For controlling heating actuators or motorised actuators
- Two front panels are included in delivery: a numerical and a relative scale
- Manual override button for presence or operation modes: comfort, stand-by, temperature reduction at night, frost protection
- 4 binary inputs for conventional switches/sensors (switching, dimming, blinds), also for external temperature sensor, window contact or presence signal
- Display of the current operating mode and heating/cooling mode through multi-colored LED

Product selection

Type	Article number
AMUN 716 S KNX	7169230

Technical data

AMUN 716 S KNX			
Operating voltage KNX	Bus voltage, ≤15 mA	Contact voltage	5 V, Internal provided
Measuring range CO ₂	300–5000 ppm	Contact current	0,5 mA
Measuring range temperature	-5 °C ... +45 °C	Number of inputs	4
Measuring range humidity	1–100 % rH	Ambient temperature	+5 °C ... +40 °C
Measuring range air pressure	30000–110000 Pa	Type of protection	IP 20
Interface extension max.	30 m	Protection class	III according to EN 60 730-1

Accessories

Flush-mounted temperature sensor

Details page 361

Temperature sensor

Details page 361

Temperature sensor RAMSES IP 65

Details page 361

Scale drawings

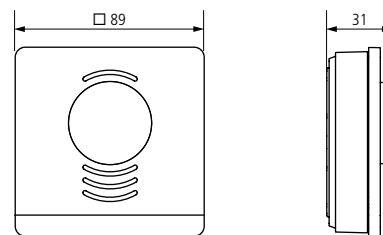

AMUN 716 KNX



RAMSES 713 FC KNX

Description

- Individual room thermostat fan coil
- For control of fan coil
- Continuous PI controller for heating and cooling
- Two rotary controls are included in delivery: an absolute scale (mounted) and 1 relative scale (enclosed)
- Rotary control can be limited mechanically or via parameters.
- Manual button for OFF, Auto, fan stages 1, 2, 3 operation modes
- 3 binary inputs for conventional switches/sensors (switching, dimming, blinds), also for external temperature sensor, window contact or presence signal
- LED (red) for heating mode, (blue) for cooling mode
- With integrated bus coupling unit

Product selection

Type	Article number
RAMSES 713 FC KNX	7139202

Technical data

RAMSES 713 FC KNX			
Operating voltage KNX	Bus voltage, ≤10 mA	Setting range temperature	+10 °C ... +28 °C
Ambient temperature	+0 °C ... +50 °C	Type of protection	IP 20
Measuring range temperature	+0 °C ... +40 °C	Protection class	II according to EN 60 730-1

Accessories

External temperature sensor 1

Details page 360

Scale drawings

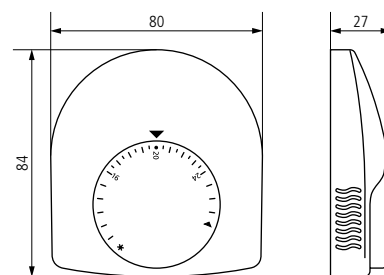

RAMSES 713 FC KNX

Home and building control

KNX, HVAC controller

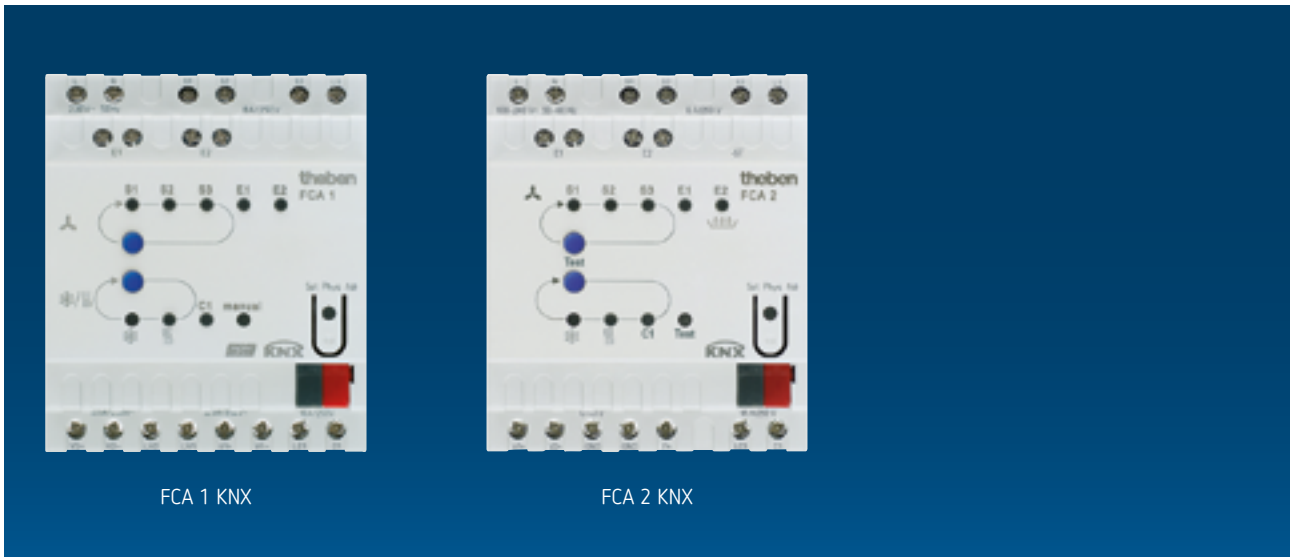

FCA 1 KNX

FCA 2 KNX

Description

Common functions

- Fan coil actuator
- For controlling fan coils
- For 2 and 4 pipe systems
- For up to three fan stages
- Additional relay for electrical heater or cooler bank
- Potential-free input for window contacts or temperature sensor
- Potential-free, condensation monitoring
- Display of operation status via 9 LEDs
- Manual operation on device (fan stages, switching between heating and cooling)
- Adjustment of setpoint value for cooling in relation to external temperature
- Potential-free switching contact for either cooler or heater bank
- With emergency program

FCA 1 KNX

- For 2-way and 3-way valves

FCA 2 KNX

- Optionally with 0-10 V fan control
- For proportional 0-10 V valves

Product selection

Type	Article number
FCA 1 KNX	4920200
FCA 2 KNX	4920210

Technical data

	FCA 1 KNX	FCA 2 KNX
Operating voltage KNX	Bus voltage, ≤10 mA	Bus voltage, ≤8 mA
Operating voltage	220–230 V AC	100–240 V AC
Frequency	50–60 Hz	
Stand-by consumption	1,9 W	0,5 W
Width	4 modules	
Max. cable cross section	Solid wire: 0.5 mm ² to 6 mm ² Stranded wire with end sleeve: 0.5 mm ² to 4 mm ²	
Type of contact	Triac	NO contact
Switching capacity additional relay	16 A	
Switching capacity blower relay	8 A	6 A
Ambient temperature	-5 °C ... +45 °C	
Type of protection	IP 20	
Protection class	II according to EN 60 730-1	

Accessories



Temperature sensor RAMSES IP65
↳ Art.No.: 9070459
Details page 361



Temperature sensor
↳ Art.No.: 9070321
Details page 361



Flush-mounted temperature sensor
↳ Art.No.: 9070496
Details page 361



Connection diagrams

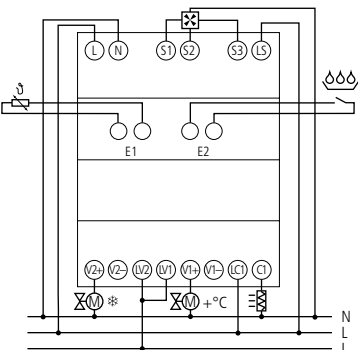

FCA 1 KNX

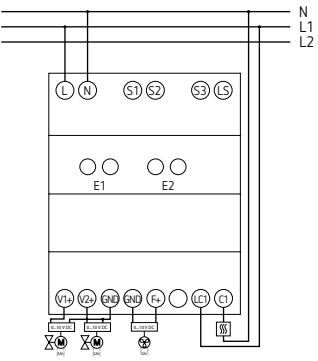

FCA 2 KNX

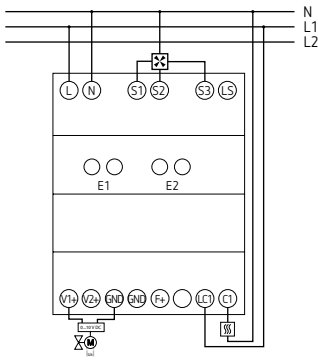

FCA 2 KNX

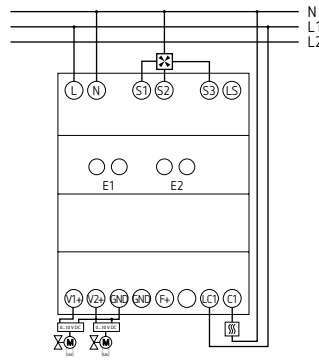

FCA 2 KNX

Home and building control

KNX, Digital time switches



TR 648 top2 RC KNX



TR 648 top2 RC-DCF KNX

Description

Common functions

- Digital time switch with yearly and astronomical time program
- 8 channels
- DuoFix spring terminals for 2 conductors each
- Text-oriented user guidance in display
- 800 memory locations
- Interface for OBELISK top2 memory card (PC programming)
- 8 year power reserve (lithium battery)
- ON-OFF switching times
- Pulse program
- Cycle program
- Extensive yearly clock functions

- Astronomical switching function (automatic calculation of sunrise and sunset times for the whole year)
- Switching preselection
- Permanent switching ON/OFF
- Count-down timer
- Integrated hour counter
- Holiday program
- 2 random programs
- Display backlight (can be turned off)
- PIN coding
- Automatic summer / winter time changeover
- Time and date synchronisation of other bus participants

TR 648 top2 RC KNX

- Time synchronisation via connection of external DCF or GPS antennas, additional positioning for astronomical program with GPS

TR 648 top2 RC-DCF KNX

- Time synchronisation via connection of external DCF antenna
- Can be operated without mains supply

Product selection

Type	Article number
TR 648 top2 RC KNX	6489212
TR 648 top2 RC-DCF KNX	6489210



Technical data

	TR 648 top2 RC KNX	TR 648 top2 RC-DCF KNX
Operating voltage KNX	Bus voltage, ≤ 12 mA	
Operating voltage	110–240 V AC	–
Frequency	50–60 Hz	–
Stand-by consumption	0,2 W	–
Width	3 modules	
Number of channels	8	
Number of memory locations	800	
Time accuracy at 25 °C	$\leq \pm 0,5$ s/day (quartz) or DCF77/GPS	$\leq \pm 0,5$ s/day (quartz) or DCF77
Shortest switching times	1 s	
Display	LCD	
Ambient temperature	–5 °C ... +45 °C	
Type of protection	IP 20	
Protection class	II according to EN 60 730-1	III according to EN 60 730-1

Accessories



Antenna RC-GNSS
for TR 648 top2 RC KNX
↳ Art.No.: 9070823
↳ Details page 353



Antenna RC-DCF
↳ Art.No.: 9070410
Details page 353



PC set OBELISK top2
↳ Art.No.: 9070409
Details page 352



Memory card OBELISK top2
↳ Art.No.: 9070404
Details page 353

Connection diagrams

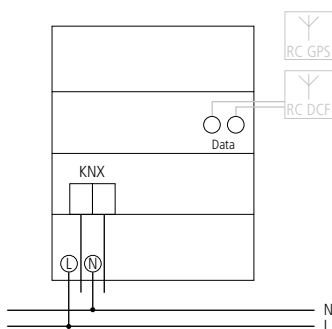

TR 648 top2 RC KNX

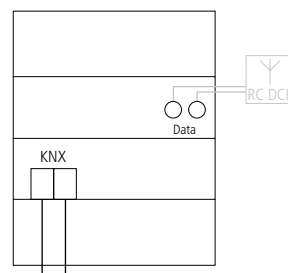

TR 648 top2 RC-DCF KNX

Home and building control

KNX, Weather station, brightness sensor



Description

Meteodata 140 S KNX

- Self-contained outdoor weather station
- For measuring wind, rain, brightness and temperature
- For fully automatic blinds and sun protection control with automatic adjustment of blinds according to position of the sun
- Rain sensor with integrated heating
- The weather station can also be operated without mains supply. The heating of the rain sensor will not function then
- Measurement and evaluation directly on device
- Sun protection for up to eight facades via 3 integrated brightness sensors
- 8 sun protection channels
- 4 additional threshold channels for connection of external KNX sensors
- 6 logic channels
- Display of weather data e.g. with VARIA 826 KNX multi-function display

Meteodata 140 S GPS KNX

As Meteodata 140 S KNX, but

- Integrated GPS receiver (provides additionally time information)
- Automatic calculation of elevation and azimuth
- The weather station can also be operated without mains supply. The GPS module will not function then

Meteodata 140 basic KNX

As Meteodata 140 S KNX, but:

- Without rain sensor
- No automatic adjustment of blinds according to position of the sun
- 3 sun protection channels

Product selection

Detection	GPS module integrated	Operating voltage	Type	Article number
Wind, Rain, Brightness, Temperature	-	110–230 V AC	Meteodata 140 S KNX	1409207
Wind, Brightness, Temperature	-	-	Meteodata 140 basic KNX	1409205
Wind, Rain, Brightness, Temperature, Time	✓	110–230 V AC	Meteodata 140 S GPS KNX	1409208
Wind, Rain, Brightness, Temperature	-	15–34 V DC	Meteodata 140 S 24V KNX	1409201
Wind, Rain, Brightness, Temperature, Time	✓	15–34 V DC	Meteodata 140 S 24V GPS KNX	1409204

Technical data

	Meteodata 140 S GPS KNX	Meteodata 140 S KNX	Meteodata 140 S 24V GPS KNX	Meteodata 140 S 24V KNX	Meteodata 140 basic KNX
Operating voltage	110–230 V AC		15–34 V DC		-
Frequency	50–60 Hz		-		
Operating voltage KNX	Bus voltage, ≤ 10 mA				
Stand-by consumption	< 0,5 W				
Measuring range brightness	1–100000 lx				
Measuring range temperature	-30 °C ... +60 °C				
Measuring range wind speed	2–30 m/s				
Ambient temperature	-20 °C ... +55 °C				
Protection class	II		III		II
Type of protection	IP 44				

Accessories



Mast mounting S
↳ Art.No.: 9070928
Details page 363



Power unit 24 V DC
for Meteodata 140 KNX
↳ Art.No.: 9079330
Details page 363



Scale drawings

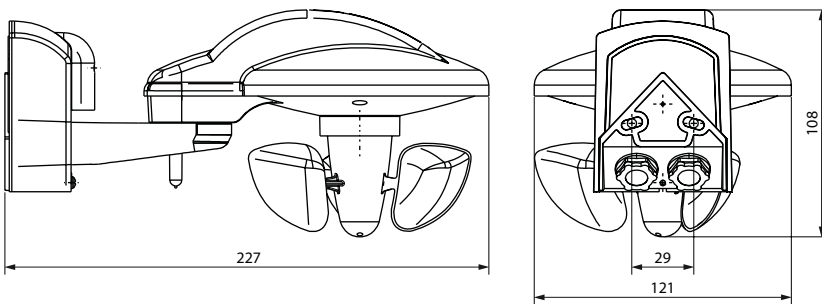

Meteodata 140 KNX

Connection diagrams

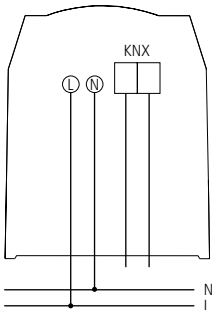

Home and building control

KNX, Weather station, brightness sensor



LUNA 134 KNX

Description

- Light level controller
- External light sensor included in delivery
- For brightness-dependent controlling
- 10 channels
- 4 threshold values channels for connecting external KNX-sensors (e.g. temperature)
- 6 logic channels
- Up to 3 lights sensors can be connected
- Manual operation on device
- 4 keys for setting threshold and switch on/off delay
- DuoFix spring terminals
- Display back light (can be turned off)
- Thresholds can be shown or changed on display
- PIN coding

Product selection

Type	Article number
LUNA 134 KNX	1349200

Technical data

LUNA 134 KNX			
Operating voltage	110–240 V AC	Width	3 modules
Frequency	50–60 Hz	Ambient temperature	-5 °C ... +45 °C
Operating voltage KNX	Bus voltage, ≤10 mA	Ambient temperature sensor	-40 °C ... +70 °C
Stand-by consumption	0,8 W	Protection class	II
Measuring range brightness	1–100000 lx	Type of protection	IP 20
On/off switching delay	0–20 min		

Accessories



Digital surface-mounted light sensor

↳ Art.No.: 9070415

Details page 359



Digital flush-mounted light sensor

↳ Art.No.: 9070456

Details page 359



Home and building control

KNX, Weather station, brightness sensor



LUNA 131 S KNX

Description

- Brightness and temperature sensor
- For brightness and temperature dependent controlling in outdoor areas
- 5 freely configurable channels: 1 sun protection channel and 4 universal channels
- Sun protection channel with automated sun protection especially for blind, awning and shutter applications
- Universal channels allow linking of brightness and temperature
- Brightness range from 1 - 100,000 lux
- Temperature range -20 °C to + 55 °C
- Learning object for brightness threshold

Product selection

Type	Article number
LUNA 131 S KNX	1319201

Technical data

LUNA 131 S KNX			
Operating voltage KNX	Bus voltage, ≤ 5 mA	Ambient temperature	-25 °C ... +55 °C
Measuring range brightness	1 – 100000 lx	Type of protection	IP 54
Measuring range temperature	-20 °C ... +55 °C		

Accessories

Mast mounting S

Details page 363

Scale drawings

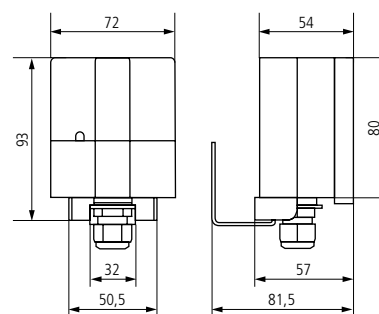

LUNA 131 S KNX



Description

- Brightness sensor
- For brightness dependent controlling in outdoor areas
- Brightness range from 1 - 100,000 lux
- Ideally combinable with the Theben weather stations for individual control of several facades

Product selection

Type	Article number
LUNA 133 KNX	1339200

Technical data

LUNA 133 KNX			
Operating voltage KNX	Bus voltage, ≤ 5 mA	Ambient temperature	-25 °C ... +55 °C
Measuring range brightness	1 – 100000 lx	Type of protection	IP 54

Accessories

Mast mounting S
Details page 363

Scale drawings

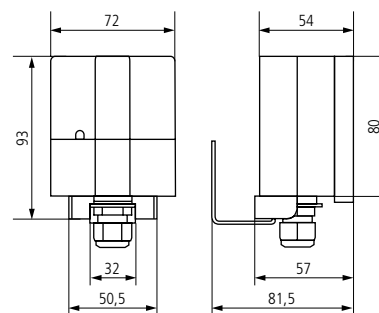

LUNA 133 KNX



OSIRIA 220/230/240 AR KNX

OSIRIA 230 SR KNX, OSIRIA 240 SR KNX

OSIRIA 241 BR KNX, OSIRIA 241 AR KNX

Description

OSIRIA 220 AR KNX, OSIRIA 230 AR KNX, OSIRIA 240 AR KNX

- KNX indoor clock, round, single-sided
- Black bar hour and minute hands, red second hand
- White metallic dial with black arabic numerals
- Impact-resistant plastic housing
- Matte border
- Flat, shock-resistant Plexiglas
- Diameter dial: 250 mm/300 mm/400 mm

OSIRIA 230 SR KNX, OSIRIA 240 SR KNX

- KNX indoor clock, round, single-sided
- Black bar hour and minute hands, red second hand
- White metallic dial with black fine-line numerals
- Impact-resistant plastic housing
- Matte border
- Flat, shock-resistant Plexiglas
- Diameter dial: 300 mm/400 mm

OSIRIA 241 BR KNX, OSIRIA 241 AR KNX

- KNX indoor clock, round, single-sided
- Silver metallic painted metallic housing (RAL 9006 white-aluminium)
- Black bar hour and minute hands, red second hand
- White metallic dial with black DIN bar numerals or arabic numbers
- Curved, shock-resistant Plexiglas
- Diameter dial: 400 mm

Product selection

Dial dimensions	Housing material	Type of numerals	Type	Article number
Ø 250 mm	Plastic housing	Arabic numerals	OSIRIA 220 AR KNX	5009200
Ø 300 mm	Plastic housing	Arabic numerals	OSIRIA 230 AR KNX	5009210
		Fineline numerals	OSIRIA 230 SR KNX	5009211
Ø 400 mm	Plastic housing	Arabic numerals	OSIRIA 240 AR KNX	5009230
		Fineline numerals	OSIRIA 240 SR KNX	5009231
	Silver metallic painted metallic housing	Arabic numerals	OSIRIA 241 AR KNX	5009240
		Bar numerals	OSIRIA 241 BR KNX	5009241



OSIRIA 242 AR KNX, OSIRIA 242 SR KNX

OSIRIA 251 BQ KNX

OSIRIA 232 BQ KNX

Description

OSIRIA 242 AR KNX, OSIRIA 242 SR KNX

- KNX indoor clock, round, double-sided
- With wall or ceiling holder (150 mm)
- White dials
- Black Arabic numerals
- Black bar hour and minute hands, red second hand
- White painted metallic housing
- Shock-resistant plexiglass
- Diameter dial: 400 mm

OSIRIA 251 BQ KNX

- KNX indoor clock, square, single-sided
- Wall clock limited protected against thrown balls e.g. for sports halls, schools, etc.
- White metallic dial with black DIN bar numerals
- Black bar hour and minute hands, red second hand
- Single-faced, robust, white painted metallic housing (RAL 9016) for heavy-duty applications
- Laminated safety glass
- 3-point fastening resistant to being pried out
- Dial: 400 mm x 400 mm

OSIRIA 232 BQ KNX

- KNX indoor clock, square, single-sided, for flush-mounted installation (for OP rooms)
- White metallic dial with black DIN bar numerals
- Black bar hour and minute hands, red second hand
- Stainless steel housing frame flush with tiles or wall V4A for wall installation (flush-mounted)
- Resistant to acids, cleaning agents and disinfectants; in the installed state protected against dust and water in acc. with protection rating IP 54 (DIN 40050)
- 3 mm flat mineral lens
- Dial: 250 x 250 mm

Product selection

Dial dimensions	Housing material	Type of numerals	Type	Article number
Ø 400 mm	White painted metallic housing	Arabic numerals	OSIRIA 242 AR KNX	5009250
		Fineline numerals	OSIRIA 242 SR KNX	5009251
400 mm x 400 mm	White painted metallic housing	Bar numerals	OSIRIA 251 BQ KNX	5009252
250 mm x 250 mm	Rustproof high quality steel housing	Bar numerals	OSIRIA 232 BQ KNX	5009223

theMura – universal masters of energy-efficient lighting control

Theben theMura flush-mounted motion and presence detectors are suitable for universal use with the switch ranges of all leading manufacturers. The scope of supply depends on the respective switch range. The easy and flexible solution for energy-efficient lighting control!

For more information, see Page 160 or visit www.theben.de/theMura-en



theMura basic unit
(theMura S180 ... B UP)

Cover set,
available as an accessory
e.g. BJ adapter frame +
button cover
(Item no. 9070788)

Frame
(from switch manufacturer)
e.g. BJ balance SI frame
(not included
in scope of delivery!)



Thanks to their extra-flat design, these units have an especially unobtrusive appearance wherever they're installed. And due to the wide range of available accessory sets, they can be used for all popular switch ranges. Simply clever. Simply beautiful. Simply Theben.

Attractive and clever – the power of versatility

theMura wall detectors are perfect for energy-efficient lighting control, e.g. in corridors, stairways, cellars and toilets – available as a motion or presence detector version. When combined with a staircase light timer switch from Theben, the 2-wire detectors are absolutely ideal for renovations and conversions. The 3-wire detectors can also be used in new buildings and offer some handy additional functions, particularly when purchased as a presence detector.



Presence and motion detectors

Two in one: With integrated button

The lighting can be switched on and off manually using the integrated button. If the function is not required, simply deactivate it.

Perfectly safe: Staircase light function

With theMura, nobody trips up – not even on the stairs. The light can be switched on using the button, but it only goes off when there is no more movement on the stairs. This prevents you from being left in the dark because someone has turned off the lights.

Clever: Teach-in function

Lighting conditions change quickly – so it's good to be able to save them easily when they are exactly how you want them to be. With the teach-in function, the current lux value can be permanently saved. And this doesn't require the end user to have any specialist knowledge. It couldn't be easier.

Presence detector

Leading the way: Orientation light

The orientation light ensures greater safety in corridors and on staircases. After the main light has been switched off automatically, it remains activated for an adjustable time delay or permanently (depending on the brightness). Safety first.

Hear ye, hear ye: Acoustic function

In rooms like bathrooms, it can make sense to let the noise level decide whether the light should be switched off or not. With theMura, you can also set the time delay using the integrated microphone. It's pretty handy.

Remote controlled: Via remote control or app

You can access the full range of functions by using the theSenda B remote control in combination with the free theSenda Plug app.

Highlights at a glance

- Attractive, flat design
- Large detection area measuring 14 x 17 m
- Flexible extension thanks to master-slave concept
- Integrated button (can be deactivated)
- Thanks to accessory sets, theMura fits perfectly into the specified switch range

Original size – just 3 mm high!

PlanoSpot 360 DALI-2 S DE WH
(4.9 m², 7 m x 7 m)

For more information, see page 172



Making light work of connections DALI-2 presence sensors

Perfect light management can also be achieved with a higher-level control system and presence sensors. The DALI-2 standard ensures compatibility across manufacturers. This allows the DALI-2 presence sensors to be operated with any multi-master application controller that complies with IEC 62386 Parts 101/104.

As an input device, the presence sensor provides information regarding presence detection and light measurements in accordance with IEC 62386 Part 303 or Part 304 via the DALI bus. The higher-level control system is responsible for providing all the functions, such as switching, constant lighting control, fully/semi-automatic device, manual override and scenes.

DALI-2 presence sensors also support remote control commands for dimming or switching lamps, controlling blinds or other functions. The presence sensor sends this information via the DALI bus to the higher-level control system as per IEC 62386 Part 301. Using this information, the control system can trigger the desired actions.

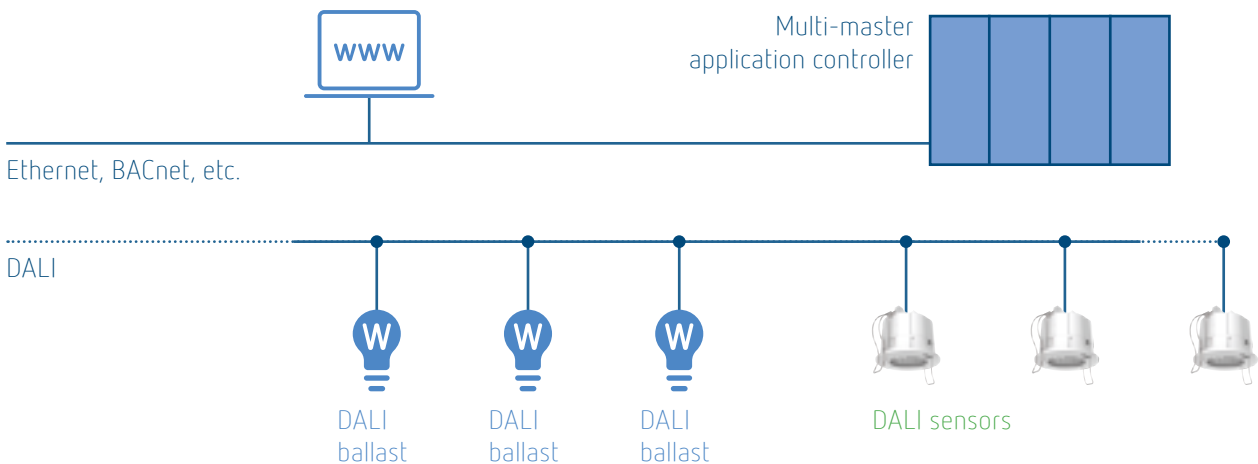



Original size

- theRonda S360 DALI-2 S UP WH (50 m², approx. ø 8 m)
- theRonda P360 DALI-2 S UP WH (452 m², approx. ø 24 m)
- thePassa P360 DALI-2 S UP WH (135 m², □ 30 x 4.5 m)

For more information, see page 168 onwards



To make your DALI lighting control even smarter, we also offer DALI presence detectors. (from page 162)

Highlights of the DALI-2 presence sensors at a glance

- **Greater flexibility**, as the DALI-2 components can be altered at any time by reassigning them without the need for rewiring or programming.
- **More safety** thanks to interoperability of all DALI-2-components and mandatory certification.
- **Easier installation** of all DALI-2 components (ECGs, sensors, buttons) on one line reduces time and material costs.
- **Various installation options:** ceiling installation, ceiling surface-mounting or flush-mounting.
- **High security of investment:** standardisation ensures compatibility across manufacturers. This makes DALI-2 sensors easier to integrate. The DALI-2 standard is synonymous with high levels of compatibility and security.

Integrated lux meter!



The perfect solution – all from a single source

DALI-2 presence sensors offer a straightforward and reliable solution for rooms where lamps need to be dimmed or switched, blinds need to be controlled or other functions need to be performed via remote control.

theSenda B remote controls (9070985) have an **integrated lux meter**. This means that the brightness value at the desired measuring point is sent directly to the DALI-2 presence sensor. As a result, the brightness measurement is calibrated virtually automatically.

Presence and motion detectors/LED spotlights





Detectors/Sensors for indoor use

	Mounting type	Detection area - Walking 3,0 m -	Detection area - Sitting 3,0 m -	Channel	Function	Protection Type	Type	Page
--	---------------	---------------------------------------	---------------------------------------	---------	----------	-----------------	------	------





Presence detectors 230 V AC

	Ceiling	50 m ² (ø 8 m 360°) *	3 m ² (ø 2,0 m 360°) *	Light	Switching	IP 55	thePiccola P360-100 DE	136
	Ceiling	50 m ² (ø 8 m 360°)	13 m ² (ø 4,0 m 360°)	Light	Switching	IP 54	theRonda S360-100 FLAT DE	138
	Ceiling	50 m ² (ø 8 m 360°)	13 m ² (ø 4,0 m 360°)	Light Presence	Switching	IP 54	theRonda S360-101 FLAT DE	138
	Ceiling	50 m ² (ø 8 m 360°)	13 m ² (ø 4,0 m 360°)	Light	Switching	IP 54	theRonda S360-100 DE	140
	Ceiling	50 m ² (ø 8 m 360°)	13 m ² (ø 4,0 m 360°)	Light	Switching	IP 54	theRonda S360-100 GST	144
	Ceiling	50 m ² (ø 8 m 360°)	13 m ² (ø 4,0 m 360°)	Light Presence	Switching	IP 54	theRonda S360-101 DE	140
	Ceiling	50 m ² (ø 8 m 360°)	13 m ² (ø 4,0 m 360°)	Light	Switching	IP 54	theRonda S360-100 AP	142
	Ceiling	50 m ² (ø 8 m 360°)	13 m ² (ø 4,0 m 360°)	Light Presence	Switching	IP 54	theRonda S360-101 AP	142
	Ceiling	50 m ² (ø 8 m 360°)	13 m ² (ø 4,0 m 360°)	Light	Switching	IP 54	theRonda S360-100 UP	146
	Ceiling	50 m ² (ø 8 m 360°)	13 m ² (ø 4,0 m 360°)	Light Presence	Switching	IP 54	theRonda S360-101 UP	146
	Ceiling	452 m ² (ø 24 m 360°)	28 m ² (ø 6,0 m 360°)	Light	Switching	IP 54	theRonda P360-100 M	148
	Ceiling	452 m ² (ø 24 m 360°)	28 m ² (ø 6,0 m 360°)	Light Presence	Switching	IP 54	theRonda P360-101 M	148
	Ceiling	452 m ² (ø 24 m 360°)	28 m ² (ø 6,0 m 360°)	Light	Switching	IP 54	theRonda P360-100 GST	150
	Ceiling	135 m ² (30,0 x 4,5 m)	–	Light Presence	Switching	IP 54	thePassa P360-101 UP	152
	Ceiling	49 m ² (7,0 x 7,0 m)	25 m ² (5,0 x 5,0 m)	Light	Switching	IP 40	thePrema S360-100 E	154
	Ceiling	49 m ² (7,0 x 7,0 m)	25 m ² (5,0 x 5,0 m)	Light Presence	Switching	IP 40	thePrema S360-101 E	154
	Ceiling	81 m ² (9,0 x 9,0 m)	49 m ² (7,0 x 7,0 m)	Light Presence	Switching	IP 40	thePrema P360-101 E	156
	Wall	100 m ² (ø 16 m) **	25 m ² (7x3,5 m) **	Light	Switching	IP 54	PresenceLight 180	158
	Wall	238 m ² (14x17 m) ***	–	Light Presence	Switching	IP 20	theMura S180-101	160

Presence detectors DALI/ DALI-2

	Ceiling	49 m ² (7,0 x 7,0 m)	25 m ² (5,0 x 5,0 m)	1 channel broadcast	DALI	IP 40	thePrema S360 DALI	162
	Ceiling	452 m ² (ø 24 m 360°)	28 m ² (ø 6,0 m 360°)	3 channels addressable	DALI-2	IP 54	theRonda P360-330 DALI	164
	Ceiling	452 m ² (ø 24 m 360°)	28 m ² (ø 6,0 m 360°)	1 channel broadcast	DALI-2	IP 54	theRonda P360-110 DALI	164
	Ceiling	50 m ² (ø 8 m 360°)	13 m ² (ø 4 m 360°)	1 channel broadcast	DALI-2	IP 54	theRonda S360-110 DALI	164
	Ceiling	135 m ² (30,0 x 4,5 m)	–	1 channel broadcast 2 channels addressable	DALI-2	IP 54	thePassa P360-221 DALI	166











Presence sensors DALI-2















	Ceiling	452 m ² (ø 24 m 360°)	28 m ² (ø 6,0 m 360°)	–	DALI-2	IP 54	theRonda P360 DALI-2 S	168
	Ceiling	50 m ² (ø 8 m 360°)	13 m ² (ø 4 m 360°)	–	DALI-2	IP 54	theRonda S360 DALI-2 S	168
	Ceiling	135 m ² (30,0 x 4,5 m)	–	–	DALI-2	IP 54	thePassa P360 DALI-2 S	170
	Ceiling	49 m ² (7,0 x 7,0 m)	20 m ² (4,5 x 4,5 m)	–	DALI-2	IP 20	PlanoSpot 360 DALI-2 S	172



Presence and motion detectors/LED spotlights

Detectors/Sensors for indoor use

	Mounting type	Detection area - Walking 3,0 m -	Detection area - Sitting 3,0 m -	Channel	Protection Type type	Page
Presence detectors 						
	Ceiling	49 m ² (7,0 x 7,0 m)	25 m ² (5,0 x 5,0 m)	2 x Light 2 x Presence	IP 40	thePrema S360 KNX UP 174
	Ceiling	81 m ² (9,0 x 9,0 m)	49 m ² (7,0 x 7,0 m)	3 x Light 2 x Presence	IP 40	thePrema P360 KNX UP 174
	Ceiling	81 m ² (9,0 x 9,0 m)	49 m ² (7,0 x 7,0 m)	3 x Light 2 x Presence	IP 40	thePrema P360 KNX AP Multi 176
	Ceiling	49 m ² (7,0 x 7,0 m)	20 m ² (4,5 x 4,5 m)	3 x Light 2 x Presence	IP 20	PlanoSpot 360 KNX DE 178
	Ceiling	452 m ² (ø 24 m 360°)	28 m ² (ø 6,0 m 360°)	2 x Light 2 x Presence	IP 54	theRonda P360 KNX UP 180
	Ceiling	50 m ² (ø 8 m 360°)	13 m ² (ø 4,0 m 360°)	2 x Light 2 x Presence	IP 54	theRonda S360 KNX AP 182
	Ceiling	50 m ² (ø 8 m 360°)	13 m ² (ø 4,0 m 360°)	2 x Light 2 x Presence	IP 54	theRonda S360 KNX FLAT DE 182
	Ceiling	135 m ² (30,0 x 4,5 m)	–	2 x Light 2 x Presence	IP 54	thePassa P360 KNX UP 184
	Ceiling	49 m ² (7,0 x 7,0 m)	25 m ² (5,0 x 5,0 m)	2 x Light 2 x Presence	IP 54	PresenceLight 360B-KNX 186
	Wall	100 m ² (ø 16 m) **	25 m ² (7x3,5 m) **	2 x Light 2 x Presence	IP 54	PresenceLight 180B-KNX 188

	Mounting type	Detection angle	Detection area - Walking 3,0 m -	Channel	LED	Switch-off delay light	Remote controllable	Type	Page
	Ceiling	360°	ø 8 m *	Light	200 W	30 s–30 min	–	thePiccola S360-100 DE	190
	Ceiling	360°	ø 8 m	Light	250 W	10 s–60 min	✓	theMova S360-100 FLAT DE	192
	Ceiling	360°	ø 8 m	Light Presence	250 W	10 s–60 min	✓	theMova S360-101 FLAT DE	192
	Ceiling	360°	ø 8 m	Light	250 W	10 s–60 min	✓	theMova S360-100 DE	194
	Ceiling	360°	ø 8 m	Light Presence	250 W	10 s–60 min	✓	theMova S360-101 DE	194
	Ceiling	360°	ø 8 m	Light	250 W	10 s–60 min	✓	theMova S360-100 AP	196
	Ceiling	360°	ø 8 m	Light Presence	250 W	10 s–60 min	✓	theMova S360-101 AP	196
	Ceiling	360°	ø 24 m	Light	600 W	10 s–60 min	✓	theMova P360-100 UP	200
	Ceiling	360°	ø 12 m	Light	400 W	5s-30 min	✓	LUXA 103-100 UA WH	206
	Wall	170°	238 m ² (14x17 m) ***	Light	450 W	10 s–30 min	–	theMura S180-100	208
	Wall	170°	238 m ² (14x17 m) ***	Light Presence	450 W	10 s–60 min	✓	theMura S180-101	208
	Wall	170°	238 m ² (14x17 m) ***	–	–	–	–	theMura S180 Slave	208
	Wall	170°	238 m ² (14x17 m) ***	Light	–	–	–	theMura S180-100 2W	208
	Wall	200°	8 m ***	Light	–	20 s–30 min	–	LUXA 103-200 T	210

* At mounting height 2,5 m

** At mounting height 2,2 m

*** At mounting height 1,1 m

Presence and motion detectors/LED spotlights

Presence detectors, 230 V AC



Description

- Passive infra-red presence detector for ceiling installation
- Circular detection area 360°, up to Ø 8 m (50 m²)
- Automatic presence- and brightness-dependent control for lighting
- Mixed light measurement suitable for fluorescent lamps (FL/PL/ESL), halogen/ incandescent lamps and LEDs
- Channel A light: relay, 230 V
- Choice of fully or semi-automatic operation
- Brightness switching value configurable, teach-in function
- Pulse function for staircase light time switch
- Time delay configurable
- Test mode for checking function and detection area
- Connection option for sensor for manual switching
- Extension of detection area via Master/ Slave switching
- Ready for immediate use due to factory presetting
- Diameter of ceiling cutout 34–36 mm
- Remote controllable with optionally remote controls theSenda B, theSenda P and theSenda S

Product selection

Installation type	Channel	Operating voltage	Colour	Type	Article number
Ceiling installation	Light	110–240 V AC	White	thePiccola P360-100 DE WH	2090200

Technical data

thePiccola P360-100 DE WH			
Operating voltage	110–240 V AC	Fluorescent lamp load (conventional) series-corrected	2000 VA
Frequency	50–60 Hz	Fluorescent lamp load (electronic ballast)	1200 W
Installation height	2–6 m	LED lamp < 2 W (typ.)	55 W
Power consumption	0,4 W	LED lamp > 2 W (typ.)	600 W
Setting range brightness	5–1000 lx	Ambient temperature	–20 °C ... +50 °C
Light switch-off delay	30 s–30 min	Type of protection	IP 44 (Sensor), IP 20 (power module) (when mounted)
Incandescent/halogen lamp load	2000 W		
Fluorescent lamp load (conventional) not corrected	2000 VA		
Fluorescent lamp load (conventional) parallel-corrected	1300 VA, 140 µF		

Detection range (Round)

Mounting height (A)	Sitting (S)	Head on to (r)	Diagonally (T)
2,5 m	3 m ² 2 m	3 m ² 2 m	50 m ² 8 m

Detection range according to sensNORM IEC 63180 see datasheet

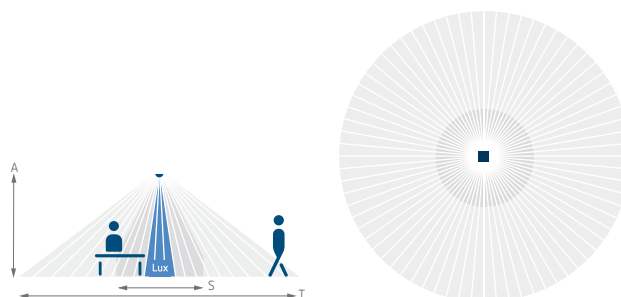

Accessories



theSenda B

↳ Art.No.: 9070985
Details page 359



theSenda P

↳ Art.No.: 9070910
Details page 359



theSenda S

↳ Art.No.: 9070911
Details page 359



Scale drawings

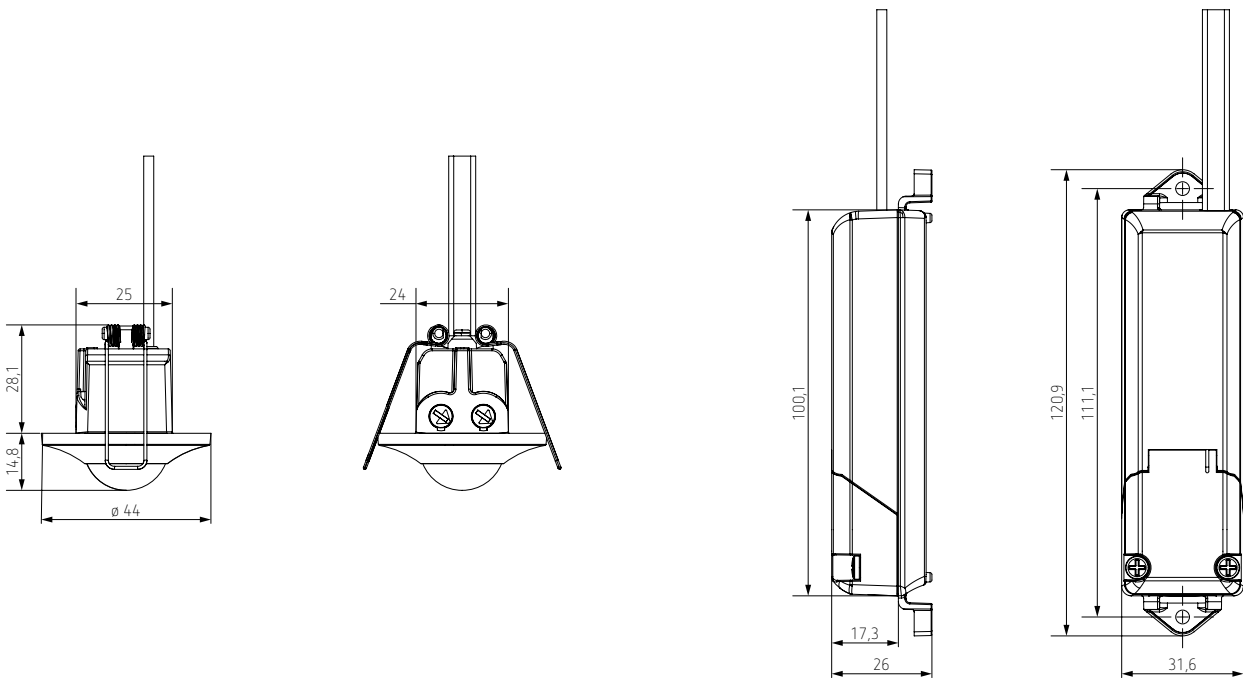

Connection diagrams

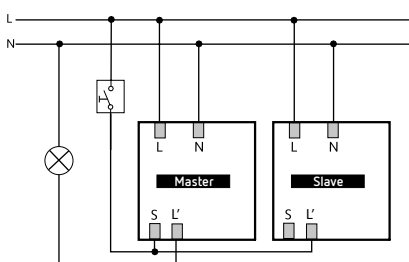

thePiccola P360-100 DE WH

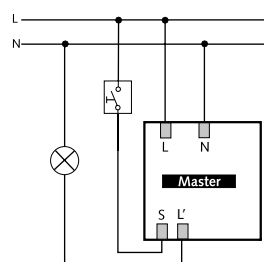

thePiccola P360-100 DE WH

Presence and motion detectors/LED spotlights

Presence detectors, 230 V AC



Description

- Passive infrared presence detector for ceiling installation
- Circular detection area 360°, up to Ø 9 m (64 m²)
- Mixed light measurement suitable for fluorescent lamps (FL/PL/ESL), halogen/ incandescent lamps and LEDs
- Channel A light: relay, 230 V
- Operation as fully automatic device
- Configurable brightness switching value, teach-in function
- Pulse function for staircase light timer switch
- Configurable time delay
- Configurable detection sensitivity
- Test mode for checking function and detection area
- Ready for immediate use due to factory presetting (brightness switching value 300 lux, time delay 10 minutes)
- One of these optional remote controls is required to change the values and settings:
 - theSenda B app remote control
 - theSenda P service remote control
 - Optional user remote control: theSenda S

theRonda S360-100 FLAT DE

- Automatic motion and brightness-dependent control for lighting

theRonda S360-101 FLAT DE

- Automatic motion and brightness-dependent control for lighting and HVAC
- Channel H, presence: relay, floating, e.g. for HVAC control
- Configurable switch-on delay and time delay

Product selection

Type	Channel	Operating voltage	Colour	Type	Article number
Presence detector	Light	230 V AC	White	theRonda S360-100 FLAT DE WH	2080540
	Light Presence	230 V AC	White	theRonda S360-101 FLAT DE WH	2080545

Technical data

	theRonda S360-100 FLAT DE WH	theRonda S360-101 FLAT DE WH
Operating voltage	230 V AC	
Frequency	50 Hz	
Power consumption	0.5 W	
Installation height	2–4 m	
Minimum height	> 1.7 m	
Brightness setting range	30–3000 lx, on	
Lighting time delay	Pulse (0.5 s), 10 s–60 min	
Incandescent/halogen lamp load	2300 W	
Compact/fluorescent lamp load	1150 VA (cos ϕ = 0.5)	
Inrush current	Max. 400 A/200 μ s	
LED lamp < 2 W (typ.)	25 W	
LED lamp > 2 W (typ.)	250 W	
Presence switching capacity	–	50 W/50 VA, max. 2 A
Presence switch-on delay	–	0 s–10 min
Presence time delay	–	10 s–120 min
Ambient temperature	–15 °C to +50 °C	
Protection rating	IP 54 (installed)	

Presence and motion detectors/LED spotlights

Presence detectors, 230 V AC

Detection area (circular)

Installation height (A)	Seated (S)	Head on to (R)	Transverse (T)
2 m	5 m ² 2.5 m	5 m ² 2.5 m	38 m ² 7 m
2.5 m	7 m ² 3 m	7 m ² 3 m	38 m ² 7 m
3 m	13 m ² 4 m	13 m ² 4 m	50 m ² 8 m
3.5 m	–	13 m ² 4 m	50 m ² 8 m
4 m	–	13 m ² 4 m	64 m ² 9 m

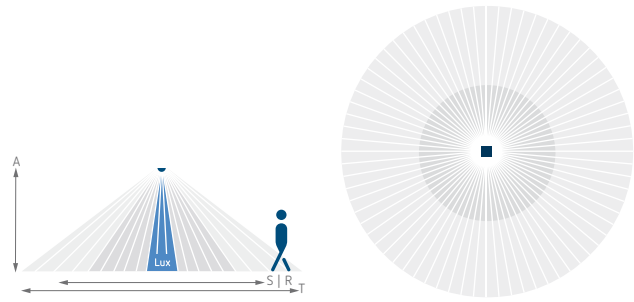

Accessories



theSenda B

↳ Art.No.: 9070985
Details page 359



theSenda P

↳ Art.No.: 9070910
Details page 359

theSenda S

Details page 359

Cover 85 FLAT GR

Details page 355

Scale drawings

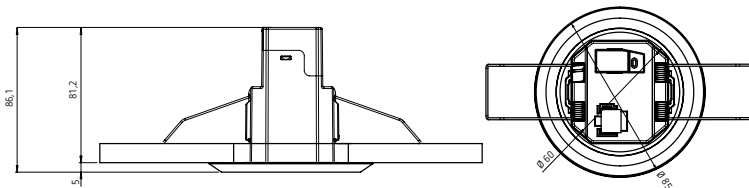

Connection example

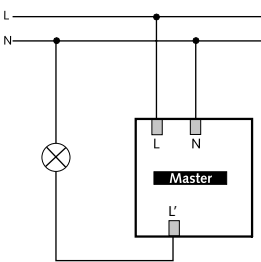

theRonda S360-100

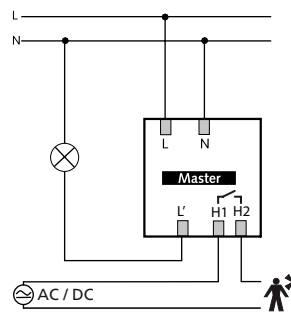

theRonda S360-101

Presence and motion detectors/LED spotlights

Presence detectors, 230 V AC



Description

- Passive infra-red presence detector for ceiling installation
- Circular detection area 360°, up to Ø 9 m (64 m²)
- Mixed light measurement suitable for fluorescent lamps (FL/PL/ESL), halogen/ incandescent lamps and LEDs
- Channel A light: relay, 230 V
- Operation as fully automatic device
- Brightness switching value configurable, teach-in function
- Pulse function for staircase light time switch
- Time delay configurable
- Detection sensitivity configurable
- Test mode for checking function and detection area
- Ready for immediate use due to factory presetting (Brightness switching value 300 lux, Time delay 10 min)
- One of these optional remote controls is required for changing the values and attitudes:
 - Management remote control theSenda B
 - Installation remote control theSenda P
 - Optional user remote control: theSenda S

theRonda S360-100 DE

- Automatic motion and brightness-dependent control for lighting

theRonda S360-101 DE

- Automatic motion and brightness-dependent control for lighting and HVAC
- Channel H, presence: relay, floating e.g. for HVAC control

Product selection

Installation type	Channel	Operating voltage	Colour	Type	Article number
Ceiling installation	Light	230 V AC	White	theRonda S360-100 DE WH	2080560
	Light Presence	230 V AC	White	theRonda S360-101 DE WH	2080565

Further colours with accessory possible

Technical data

	theRonda S360-100 DE	theRonda S360-101 DE
Operating voltage	230 V AC	
Frequency	50 Hz	
Installation height	2 – 4 m	
Minimum height	> 1,7 m	
Setting range brightness	30 – 3000 lx	
Light switch-off delay	10 s – 60 min	
Incandescent/halogen lamp load	2300 W	
Inrush current	max. 400 A/200 µs	
LED lamp < 2 W (typ.)	25 W	
LED lamp 2 – 8 W (typ.)	70 W	
LED lamp > 8 W (typ.)	80 W	
Switching capacity presence	–	50 W/50 VA, max. 2 A
Ambient temperature	– 15 °C ... +50 °C	
Type of protection	IP 54 (when fitted)	

Presence and motion detectors/LED spotlights

Presence detectors, 230 V AC

Detection range (Round)

Mounting height (A)	Sitting (S)	Walking head on to (R)	Walking diagonally (T)
2 m	5 m ² 2,5 m	5 m ² 2,5 m	38 m ² 7 m
2,5 m	7 m ² 3 m	7 m ² 3 m	38 m ² 7 m
3 m	13 m ² 4 m	13 m ² 4 m	50 m ² 8 m
3,5 m	–	–	50 m ² 8 m
4 m	–	–	64 m ² 9 m

Detection range according to sensNORM IEC 63180 see datasheet

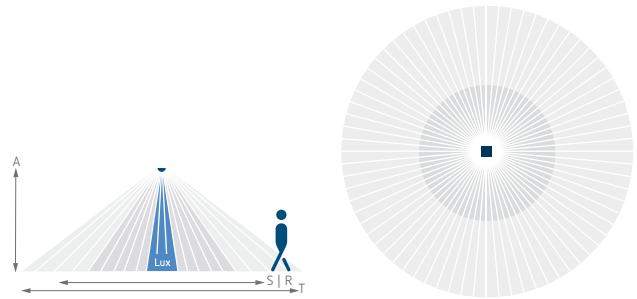

Accessories



theSenda B

↳ Art.No.: 9070985

Details page 359

[Scale drawings](#)



theSenda P

↳ Art.No.: 9070910

Details page 359

theSenda S

Details page 359

Cover 85 GR

Details page 355

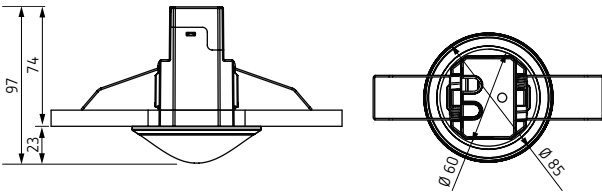

Connection diagrams

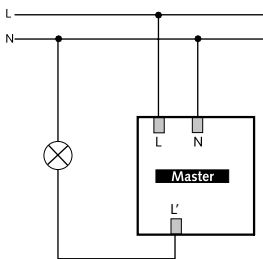

theRonda S360-100 DE

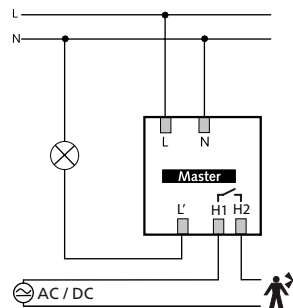

theRonda S360-101 DE

Presence and motion detectors/LED spotlights

Presence detectors, 230 V AC

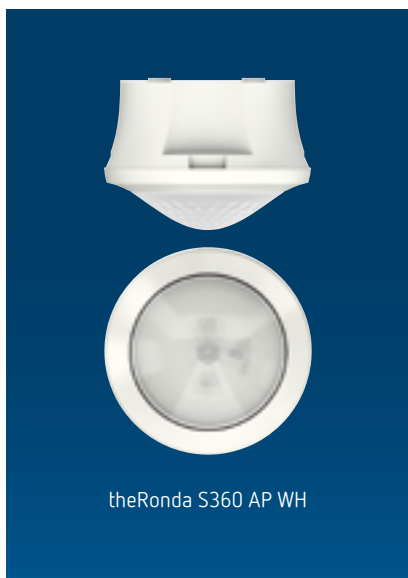

Description

- Passive infra-red presence detector for ceiling installation
 - Circular detection area 360°, up to Ø 9 m (64 m²)
 - Mixed light measurement suitable for fluorescent lamps (FL/PL/ESL), halogen/ incandescent lamps and LEDs
 - Channel A light: relay, 230 V
 - Operation as fully automatic device
 - Brightness switching value configurable, teach-in function
 - Pulse function for staircase light time switch
 - Time delay configurable
 - Detection sensitivity configurable
 - Test mode for checking function and detection area
 - Ready for immediate use due to factory presetting (Brightness switching value 300 lux, Time delay 10 min)
 - One of these optional remote controls is required for changing the values and attitudes:
 - Management remote control theSenda B
 - Installation remote control theSenda P
 - Optional user remote control: theSenda S
- theRonda S360-100 AP**
- Automatic motion and brightness-dependent control for lighting
- theRonda S360-101 AP**
- Automatic motion and brightness-dependent control for lighting and HVAC
 - Channel H, presence: relay, floating e.g. for HVAC control

Product selection

Installation type	Channel	Operating voltage	Colour	Type	Article number
Ceiling installation	Light	230 V AC	White	theRonda S360-100 AP WH	2080550
			Grey	theRonda S360-100 AP GR	2080551
	Light Presence	230 V AC	White	theRonda S360-101 AP WH	2080555
			Grey	theRonda S360-101 AP GR	2080556

Technical data

	theRonda S360-100 AP	theRonda S360-101 AP
Operating voltage	230 V AC	
Frequency	50 Hz	
Installation height	2 – 4 m	
Minimum height	> 1,7 m	
Setting range brightness	30 – 3000 lx	
Light switch-off delay	10 s – 60 min	
Incandescent/halogen lamp load	2300 W	
Inrush current	max. 400 A/200 µs	
LED lamp < 2 W (typ.)	25 W	
LED lamp 2 – 8 W (typ.)	70 W	
LED lamp > 8 W (typ.)	250 W	
Switching capacity presence	–	50 W/50 VA, max. 2 A
Ambient temperature	–15 °C ... +50 °C	
Type of protection	IP 54	

Presence and motion detectors/LED spotlights

Presence detectors, 230 V AC

Detection range (Round)

Mounting height (A)	Sitting (S)	Walking head on to (R)	Walking diagonally (T)
2 m	5 m ² 2,5 m	5 m ² 2,5 m	38 m ² 7 m
2,5 m	7 m ² 3 m	7 m ² 3 m	38 m ² 7 m
3 m	13 m ² 4 m	13 m ² 4 m	50 m ² 8 m
3,5 m	–	–	50 m ² 8 m
4 m	–	–	64 m ² 9 m

Detection range according to sensNORM IEC 63180 see datasheet

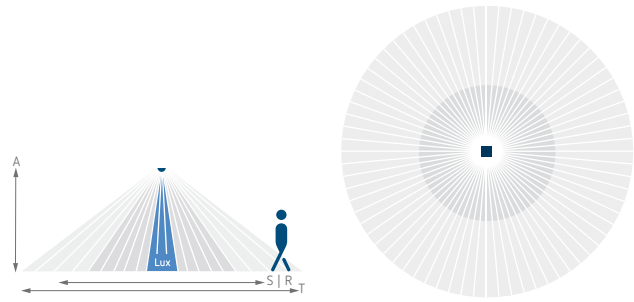

Accessories



theSenda B

↳ Art.No.: 9070985
Details page 359



theSenda P

↳ Art.No.: 9070910
Details page 359



theSenda S

↳ Art.No.: 9070911
Details page 359

Scale drawings

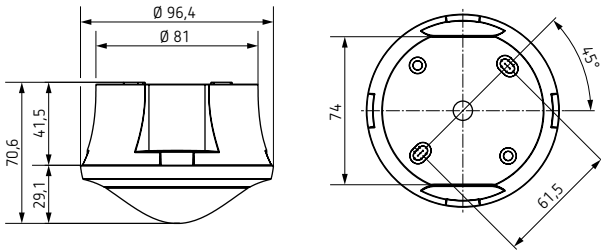

Connection diagrams

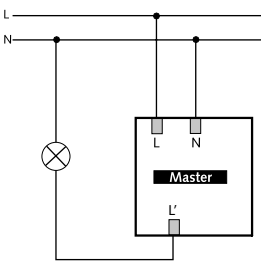

theRonda S360-100 AP

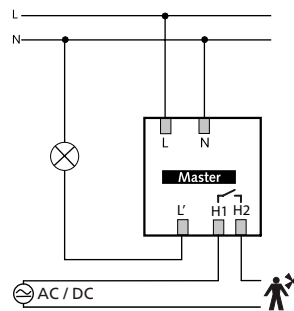

theRonda S360-101 AP

Presence and motion detectors

Presence detectors, 230 V AC



Description

- Presence detector (PIR), with pre-configured cable and Wieland GSTi18 connector, cable length 1.50 meter
- Circular detection area 360°, up to Ø 9 m (64 m²)
- Automatic motion and brightness-dependent control for lighting
- Mixed light measurement suitable for fluorescent lamps (FL/PL/ESL), halogen/ incandescent lamps and LEDs
- Channel A light: relay, 230 V
- Operation as fully automatic device
- Brightness switching value configurable, teach-in function
- Pulse function for staircase light time switch
- Time delay configurable
- Detection sensitivity configurable
- Test mode for checking function and detection area
- Ready for immediate use due to factory presetting (Brightness switching value 300 lux, Time delay 10 min)
- One of these optional remote controls is required for changing the values and attitudes:
 - Management remote control theSenda B
 - Installation remote control theSenda P
 - Optional user remote control: theSenda S

Product selection

Installation type	Channel	Operating voltage	Colour	Type	Article number
Ceiling installation	Light	230 V AC	White	theRonda S360-100 WH GST	2080570
Further colours with accessory possible					

Technical data

	theRonda S360-100 WH GST
Operating voltage	230 V AC
Frequency	50 Hz
Installation height	2–4 m
Minimum height	> 1,7 m
Setting range brightness	30–3000 lx
Light switch-off delay	10 s–60 min
Incandescent/halogen lamp load	2300 W
Inrush current	max. 400 A/200 µs
LED lamp < 2 W (typ.)	25 W
LED lamp 2–8 W (typ.)	70 W
LED lamp > 8 W (typ.)	250 W
Ambient temperature	–15 °C ... +50 °C
Type of protection	IP 54 (when fitted)

Presence and motion detectors/LED spotlights

Presence detectors, 230 V AC

Detection range (Round)

Mounting height (A)	Sitting (S)	Walking head on to (R)	Walking diagonally (T)
2 m	5 m ² 2,5 m	5 m ² 2,5 m	38 m ² 7 m
2,5 m	7 m ² 3 m	7 m ² 3 m	38 m ² 7 m
3 m	13 m ² 4 m	13 m ² 4 m	50 m ² 8 m
3,5 m	–	–	50 m ² 8 m
4 m	–	–	64 m ² 9 m

Detection range according to sensNORM IEC 63180 see datasheet

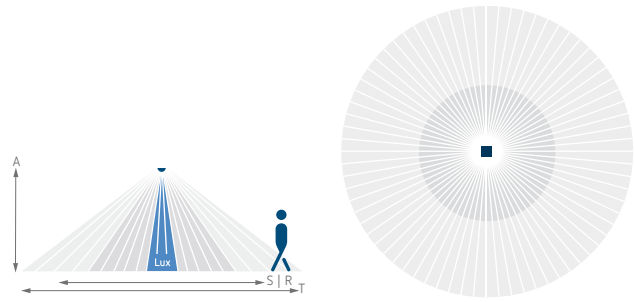

Accessories



theSenda B

↳ Art.No.: 9070985
Details page 359



theSenda P

↳ Art.No.: 9070910
Details page 359

theSenda S

Details page 359

Cover 85 GR

Details page 355

Scale drawings

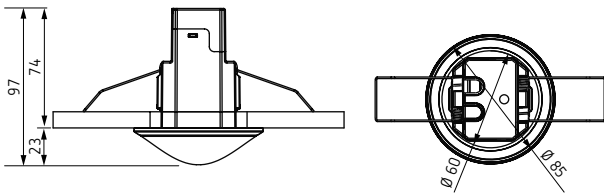

Connection diagrams

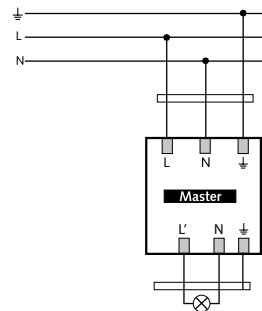

Presence and motion detectors/LED spotlights

Presence detectors, 230 V AC



Description

- Passive infrared presence detector for ceiling mounting
 - Round detection area 360°, up to Ø 9 m (64 m²)
 - Mixed light measurement suitable for fluorescent lamps (FL/PL/ESL), halogen/ incandescent lamps and LEDs
 - Channel A, light: relay, 230V
 - Choice of fully or semi-automatic operation
 - Adjustable brightness switching value, teach-in function
 - Reduction of switch-off delay time in the event of short presence (brief-presence)
 - Connection option for sensors or switches for manual switching with automatic recognition of sensor/switch
 - Pulse function for staircase light time switch
 - Switch-on delay and switch-off delay configurable
 - Sensitivity adjustable
 - Detection area can be limited using cover clip
 - Ready for immediate use due to factory preset
 - An optional remote control is required for changing the values and attitudes
 - Test mode for checking function and detection area
 - Ceiling installation in flush-mounted socket
 - Ceiling installation also possible with surface-mounted frame
 - User remote control theSenda S, service remote control theSenda P, management remote control theSenda B (optional)
- theRonda S360-100 UP**
- Automatic presence- and brightness-dependent control for lighting
- theRonda S360-101 UP**
- Automatic presence- and brightness-dependent control for lighting and HVAC
 - Channel H, presence: relay, floating
 - e.g. for HVAC control
 - Switch-on delay and switch-off delay configurable
 - Extension of detection area via Master/ Slave or Master/Master switching, a maximum of 10 detectors can be switched in parallel with each other
- theRonda S360 Slave UP**
- Slave version for theRonda S360-101 UP
 - Just to be used with theRonda S360-101 UP as Master

Product selection

Installation type	Channel	Operating voltage	Colour	Type	Article number
Ceiling installation	Light	110–230 V AC	White	theRonda S360-100 UP WH	2080520
	Light Presence	110–230 V AC	White	theRonda S360-101 UP WH	2080525
	Slave	110–230 V AC	White	theRonda S360 Slave UP WH	2080530

Further colours with accessory possible

Technical data

	theRonda S360-100 UP	theRonda S360-101 UP	theRonda S360 Slave UP
Operating voltage	110–230 V AC		
Frequency	50–60 Hz		
Installation height	2–4 m		
Minimum height	> 1,7 m		
Power consumption	0,1 W		
Setting range brightness	30–3000 lx		–
Incandescent/halogen lamp load	2300 W		–
Compact and fluorescent lamps	1150 VA (cos φ = 0,5)		–
Inrush current	max. 800 A/200 μs		–
LED lamp < 2 W (typ.)	60 W		–
LED lamp 2–8 W (typ.)	180 W		–
LED lamp > 8 W (typ.)	600 W		–
Switch-on delay presence	–	0 s–10 min/Room surveillance	–

Presence and motion detectors/LED spotlights

Presence detectors, 230 V AC

	theRonda S360-100 UP	theRonda S360-101 UP	theRonda S360 Slave UP
Presence switch-off delay	–	10 s – 120 min	–
Switching capacity presence	–	50 W / 50 VA	–
Size of concealed housing	Ø 55 mm (NIS, PMI)		
Ambient temperature	–15 °C ... +50 °C		
Type of protection	IP 54 (when fitted)		

Detection range (Round)

Mounting height (A)	Sitting (S)	Walking head on to (R)	Walking diagonally (T)
2 m	5 m² 2,5 m	5 m² 2,5 m	38 m² 7 m
2,5 m	7 m² 3 m	7 m² 3 m	38 m² 7 m
3 m	13 m² 4 m	13 m² 4 m	50 m² 8 m
3,5 m	–	13 m² 4 m	50 m² 8 m
4 m	–	13 m² 4 m	64 m² 9 m

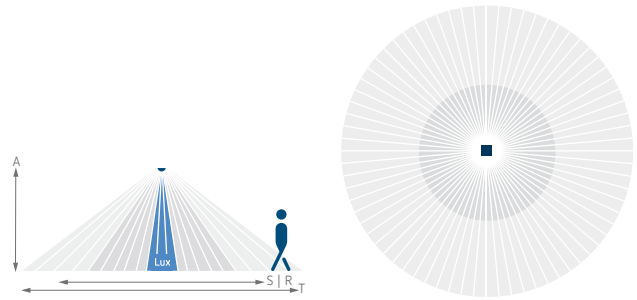

Detection range according to sensNORM IEC 63180 see datasheet

Accessories



theSenda B

↳ Art.No.: 9070985
Details page 359



theSenda P

↳ Art.No.: 9070910
Details page 359



theSenda S

↳ Art.No.: 9070911
Details page 359

QuickSafe

Details page 355

Surface frame 110A WH

Details page 354

Surface frame 110A GR

Details page 354

Ceiling installation box 68A

Details page 354

Masking clip

Details page 355

Cover 110 GR

Details page 355

Scale drawings

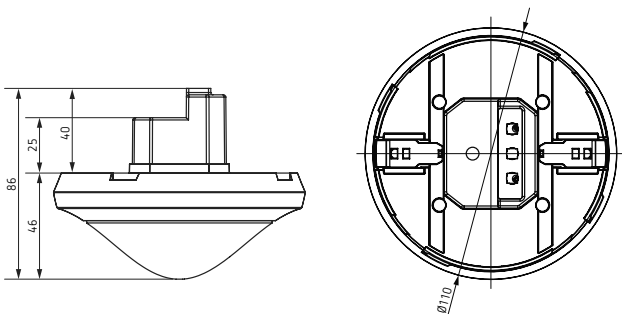

Connection diagrams

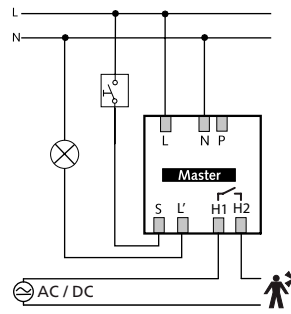

theRonda S360-101 UP

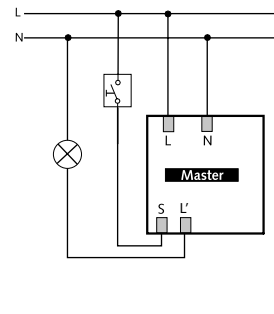

theRonda S360-100 UP

Presence and motion detectors/LED spotlights

Presence detectors, 230 V AC



Description

- Passive infrared presence detector for ceiling mounting
 - Round detection area 360°, up to Ø 24 m (452 m²)
 - Mixed light measurement suitable for fluorescent lamps (FL/PL/ESL), halogen/ incandescent lamps and LEDs
 - Channel A, light: relay, 230V
 - Choice of fully or semi-automatic operation
 - Adjustable brightness switching value, teach-in function
 - Reduction of switch-off delay time in the event of short presence (brief-presence)
 - Connection option for sensors or switches for manual switching with automatic recognition of sensor/switch
 - Pulse function for staircase light time switch
 - Switch-on delay and switch-off delay configurable
 - Sensitivity adjustable
 - Detection area can be limited using cover clip
 - Ready for immediate use due to factory preset
 - Test mode for checking function and detection area
 - Extension of detection area via Master/Slave or Master/Master switching, a maximum of 10 detectors can be switched in parallel with each other
 - Ceiling installation in flush-mounted socket
 - Ceiling installation also possible with surface-mounted frame
 - User remote control theSenda S, management remote control theSenda B (optional)
- theRonda P360-100 M**
- Automatic presence- and brightness-dependent control for lighting
- theRonda P360-101 M**
- Automatic presence- and brightness-dependent control for lighting and HVAC
 - Channel H, presence: relay, floating
 - e.g. for HVAC control
- theRonda P360 Slave**
- Slave version for theRonda P360 M
 - Just to be used with theRonda P360 M as Master

Product selection

Installation type	Channel	Operating voltage	Colour	Type	Article number
Ceiling installation	Light	110–230 V AC	White	theRonda P360-100 M UP WH	2080020
	Light Presence	110–230 V AC	White	theRonda P360-101 M UP WH	2080025
	Slave	110–230 V AC	White	theRonda P360 Slave UP WH	2080030

Further colours with accessory possible

Technical data

	theRonda P360-100 M UP	theRonda P360-101 M UP	theRonda P360 Slave UP
Operating voltage	110–230 V AC		
Frequency	50–60 Hz		
Installation height	2–15 m		
Minimum height	> 1,7 m		
Power consumption	0,15 W		
Setting range brightness	30–3000 lx		–
Light switch-off delay	10 s–60 min		–
Incandescent/halogen lamp load	2300 W		–
Compact and fluorescent lamps	1150 VA (cos φ = 0,5)		–
Inrush current	max. 800 A/200 μs		–
LED lamp < 2 W (typ.)	60 W		–
LED lamp 2–8 W (typ.)	180 W		–
LED lamp > 8 W (typ.)	600 W		–
Switch-on delay presence	–	0 s–10 min	–

Presence and motion detectors/LED spotlights

Presence detectors, 230 V AC

	theRonda P360-100 M UP	theRonda P360-101 M UP	theRonda P360 Slave UP
Presence switch-off delay	-	10 s – 120 min	-
Switching capacity presence	-	50 W/50 VA	-
Size of concealed housing	Ø 55 mm (NIS, PMI)		
Ambient temperature	-15 °C ... +50 °C		
Type of protection	IP 54 (when fitted)		

Detection range (Round)

Mounting height (A)	Sitting (S)	Walking diagonally (T)	Walking head on to (R)
2 m	16 m² 4,5 m	380 m² 22 m	28 m² 6 m
2,5 m	24 m² 5,5 m	415 m² 23 m	38 m² 7 m
3 m	28 m² 6 m	452 m² 24 m	50 m² 8 m
3,5 m	38 m² 7 m	452 m² 24 m	50 m² 8 m
6 m	-	452 m² 24 m	50 m² 8 m
10 m	-	491 m² 25 m	50 m² 8 m

With a mounting height of more than 3.5 m walking motions are necessary and the detection areas of several detectors should overlap in the marginal zone. All figures are up to values. The detection range decreases with increasing temperatures.

Detection range according to sensNORM IEC 63180 see datasheet

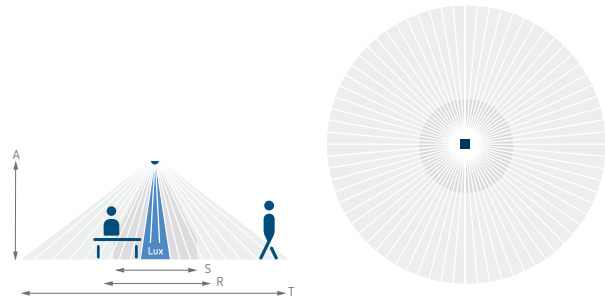

Accessories



theSenda B

↳ Art.No.: 9070985
Details page 359



theSenda P

↳ Art.No.: 9070910
Details page 359



theSenda S

↳ Art.No.: 9070911
Details page 359

QuickSafe

Details page 355

Surface frame 110A WH

Details page 354

Surface frame 110A GR

Details page 354

Ceiling installation box 68A

Details page 354

Masking clip

Details page 355

Cover 110 GR

Details page 355

Scale drawings

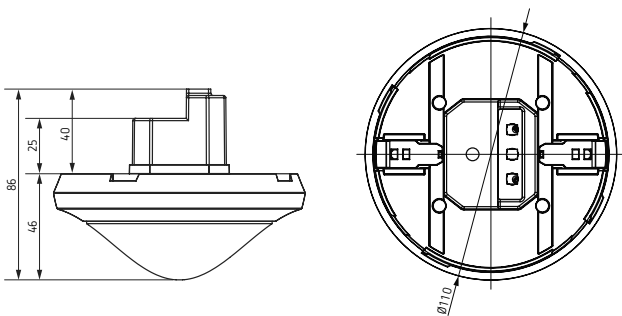

Connection diagrams

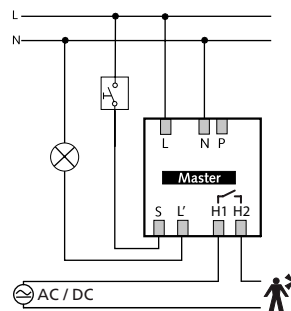

theRonda P360-101 M UP

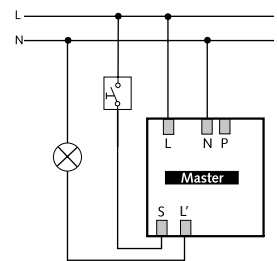

theRonda P360-100 M UP

Presence and motion detectors/LED spotlights

Presence detectors, 230 V AC



Description

- Presence detector (PIR), with pre-configured cable and Wieland GSTi18 connector, cable length 1.50 meter
- Round detection area 360°, up to Ø 24 m (452 m²)
- Automatic presence- and brightness-dependent control for lighting
- Mixed light measurement suitable for fluorescent lamps (FL/PL/ESL), halogen/ incandescent lamps and LEDs
- Channel A, light: relay, 230 V
- Choice of fully or semi-automatic operation
- Adjustable brightness switching value, teach-in function
- Reduction of switch-off delay time in the event of short presence (brief-presence)
- Connection option for sensors or switches for manual switching with automatic recognition of sensor/switch
- Pulse function for staircase light time switch
- Sensitivity adjustable
- Detection area can be limited using cover clip
- Ready for immediate use due to factory preset
- Test mode for checking function and detection area
- Ceiling installation in flush-mounted socket
- Ceiling installation also possible with surface-mounted frame
- User remote control theSenda S, management remote control theSenda B (optional)

Product selection

Installation type	Channel	Operating voltage	Colour	Type	Article number
Ceiling installation	Light	110–230 V AC	White	theRonda P360-100 WH GST	2080010

Technical data

	theRonda P360-100 WH GST
Operating voltage	110–230 V AC
Frequency	50–60 Hz
Installation height	2–15 m
Minimum height	> 1,7 m
Power consumption	0,15 W
Setting range brightness	30–3000 lx
Light switch-off delay	10 s–60 min
Incandescent/halogen lamp load	2300 W
Compact and fluorescent lamps	1150 VA (cos φ = 0,5)
LED lamp < 2 W (typ.)	60 W
LED lamp 2–8 W (typ.)	180 W
LED lamp > 8 W (typ.)	600 W
Ambient temperature	–15 °C ... +50 °C
Type of protection	IP 54 (when fitted)

Presence and motion detectors/LED spotlights

Presence detectors, 230 V AC

Detection range (Round)

Mounting height (A)	Sitting (S)	Walking diagonally (T)	Walking head on to (R)
2 m	16 m ² 4,5 m	380 m ² 22 m	28 m ² 6 m
2,5 m	24 m ² 5,5 m	415 m ² 23 m	38 m ² 7 m
3 m	28 m ² 6 m	452 m ² 24 m	50 m ² 8 m
3,5 m	38 m ² 7 m	452 m ² 24 m	50 m ² 8 m
6 m	–	452 m ² 24 m	50 m ² 8 m
10 m	–	491 m ² 25 m	50 m ² 8 m

With a mounting height of more than 3.5 m walking motions are necessary and the detection areas of several detectors should overlap in the marginal zone. All figures are up to values. The detection range decreases with increasing temperatures.

Detection range according to sensNORM IEC 63180 see datasheet

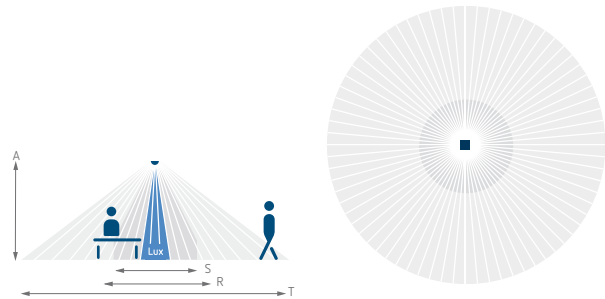

Accessories



theSenda B

↳ Art.No.: 9070985
Details page 359



theSenda P

↳ Art.No.: 9070910
Details page 359



theSenda S

↳ Art.No.: 9070911
Details page 359

Masking clip

Details page 355

QuickSafe

Details page 355

Cover 110 GR

Details page 355

Scale drawings

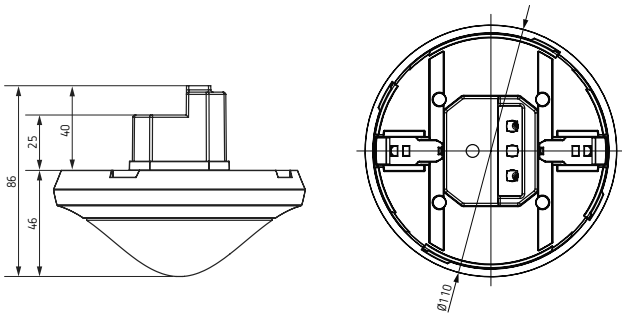

Connection diagrams

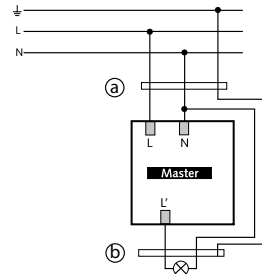

Presence and motion detectors/LED spotlights

Presence detectors, 230 V AC



Description

- Passive infrared presence detector for ceiling mounting
 - Square detection area for corridors and storage areas
 - Detection area with 2 individually connectable and disconnectable detection zones, each 15 x 5 m (total 30 x 5 m)
 - Automatic presence- and brightness-dependent control for lighting and HVAC
 - Mixed light measurement suitable for fluorescent lamps (FL/PL/ESL), halogen/ incandescent lamps and LEDs
 - Channel A, light: relay, 230V
 - Choice of fully or semi-automatic operation
 - Adjustable brightness switching value, teach-in function
 - Reduction of switch-off delay time in the event of short presence (brief-presence)
 - Connection option for sensors or switches for manual switching with automatic recognition of sensor/switch
 - Pulse function for staircase light time switch
 - Channel H, presence: relay, floating
 - e.g. for HVAC control
 - Switch-on delay and switch-off delay configurable
 - Sensitivity adjustable
 - Detection area can be limited using cover clip
 - Ready for immediate use due to factory preset
 - Test mode for checking function and detection area
 - Extension of detection area via Master/ Slave or Master/Master switching, a maximum of 10 detectors can be switched in parallel with each other
 - Ceiling installation in flush-mounted socket
 - Ceiling installation also possible with surface-mounted frame
 - User remote control theSenda S, management remote control theSenda B (optional)
- thePassa P360 Slave**
- Slave version for thePassa P360
 - Just to be used with thePassa P360 as Master

Product selection

Installation type	Channel	Operating voltage	Colour	Type	Article number
Ceiling installation	Light Presence	110–230 V AC	White	thePassa P360-101 UP WH	2010300
	Slave	110–230 V AC	White	thePassa P360 Slave UP WH	2010330

Further colours with accessory possible

Technical data

	thePassa P360-101 UP	thePassa P360 Slave UP
Operating voltage	110–230 V AC	
Frequency	50–60 Hz	
Installation height	2–15 m	
Minimum height	> 1,7 m	
Power consumption	ca. 0,1 W	
Setting range brightness	30–3000 lx	–
Incandescent/ halogen lamp load	2300 W	–
Compact and fluorescent lamps	1150 VA (cos φ = 0,5)	–
Inrush current	max. 800 A/200 μs	–
LED lamp < 2 W (typ.)	60 W	–
LED lamp 2-8 W (typ.)	180 W	–
LED lamp > 8 W (typ.)	600 W	–
Switch-on delay presence	0 s–10 min/Room surveillance	–
Presence switch-off delay	10 s–120 min	–
Switching capacity presence	50 W/50 VA	–
Size of concealed housing	Ø 55 mm (NIS, PMI)	
Ambient temperature	–15 °C ... +50 °C	
Type of protection	IP 54 (when fitted)	

Presence and motion detectors/LED spotlights

Presence detectors, 230 V AC

Detection range (Rectangular)

Mounting height (A)	Head on to (r)	Diagonally (t)
2 m	56 m ² 16 m x 3,5 m	56 m ² 16 m x 3,5 m
2,5 m	72 m ² 18 m x 4 m	88 m ² 22 m x 4 m
3 m	90 m ² 20 m x 4,5 m	135 m ² 30 m x 4,5 m
3,5 m	100 m ² 20 m x 5 m	150 m ² 30 m x 5 m
4 m	100 m ² 20 m x 5 m	150 m ² 30 m x 5 m
4,5 m	100 m ² 20 m x 5 m	150 m ² 30 m x 5 m
5 m	100 m ² 20 m x 5 m	150 m ² 30 m x 5 m
5,5 m	100 m ² 20 m x 5 m	150 m ² 30 m x 5 m
6 m	100 m ² 20 m x 5 m	150 m ² 30 m x 5 m

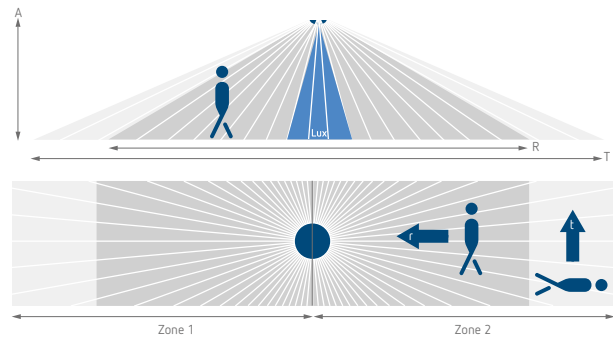

Detection range according to sensNORM IEC 63180 see datasheet

Accessories



theSenda B

↳ Art.No.: 9070985

Details page 359



theSenda P

↳ Art.No.: 9070910

Details page 359



theSenda S

↳ Art.No.: 9070911

Details page 359

QuickSafe

Details page 355

Surface frame 110A WH

Details page 354

Surface frame 110A GR

Details page 354

Ceiling installation box 68A

Details page 354

Masking clip

Details page 355

Cover 110 GR

Details page 355

Scale drawings

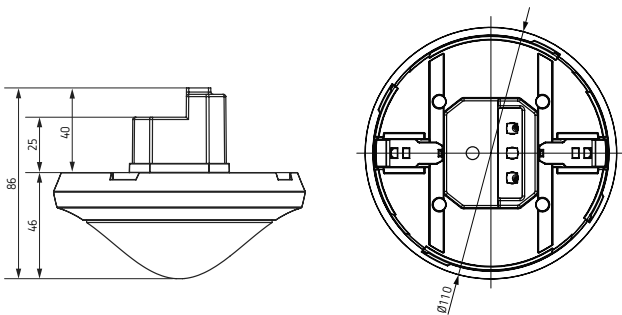

Connection diagrams

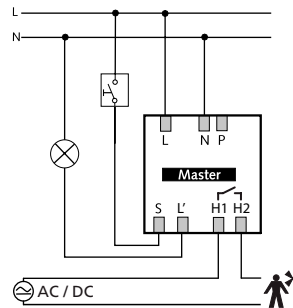

Connection diagrams

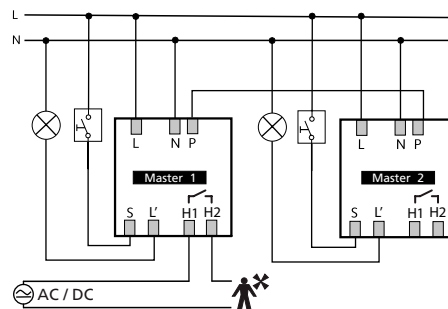
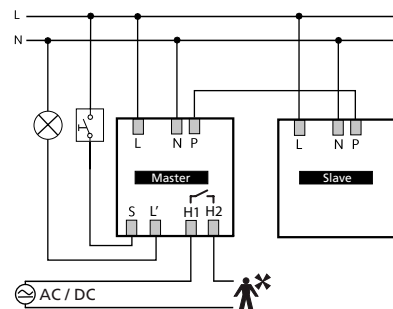

Presence and motion detectors/LED spotlights

Presence detectors, 230 V AC

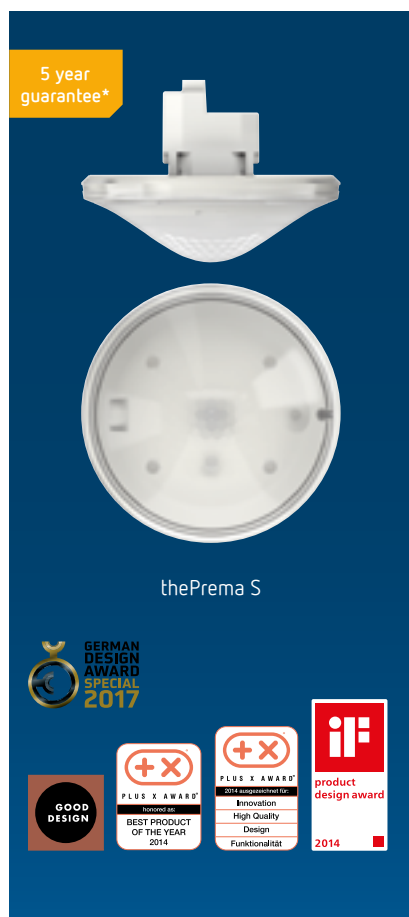

Description

- Passive infrared presence detector for ceiling mounting
 - Square detection area 360° (up to 64 m²) for reliable and easy planning
 - Mixed light measurement suitable for fluorescent lamps (FL/PL/ESL), halogen/ incandescent lamps and LEDs
 - Choice of fully or semi-automatic (absence detection) operation
 - Adjustable brightness switching value, teach-in function
 - Self-learning time delay
 - Reduction of switch-off delay time in the event of short presence (brief-presence)
 - Connection option for sensors or switches for manual switching with automatic recognition of sensor/switch
 - Pulse function for staircase light time switch
 - Switch-on delay and switch-off delay configurable
 - Room monitoring with selective movement detection
 - Exceptionally easy configuration of the energy-saving behaviour with the new «eco plus» function
 - Staircase time function
 - User remote control theSenda S, management remote control theSenda B (optional)
 - Ready for immediate use due to factory preset
 - Test mode for checking function and detection area
 - Extension of detection area via Master/Slave or Master/Master switching, a maximum of 10 detectors can be switched in parallel with each other
 - Ceiling installation in flush-mounted socket
 - Ceiling installation also possible with surface-mounted frame
- thePrema S360-101 E**
- Automatic presence- and brightness-dependent control for lighting and HVAC
 - Channel A, light: relay, 230 V
 - Channel H, presence: relay, floating e.g. for HVAC control
 - Operating mode of light and presence relay can be flexibly selected using the remote control theSenda B
- thePrema S360-100 E**
- Automatic presence- and brightness-dependent control for lighting
 - Channel A, light: relay, 230V
- thePrema S360 Slave E**
- Slave version for thePrema
 - Just to be used with thePrema as Master

* According to guarantee conditions, see www.theben.de/en/guarantee

Product selection

Installation type	Channel	Operating voltage	Colour	Type	Article number
Ceiling installation	Light Presence	110–230 V AC	White	thePrema S360-101 E UP WH	2070605
			Grey	thePrema S360-101 E UP GR	2070606
	Light	110–230 V AC	White	thePrema S360-100 E UP WH	2070600
			Grey	thePrema S360-100 E UP GR	2070601
	Slave	110–230 V AC	White	thePrema S360 Slave E UP WH	2070630
			Grey	thePrema S360 Slave E UP GR	2070631

Technical data

	thePrema S360-101 E UP	thePrema S360-100 E UP	thePrema S360 Slave E UP
Operating voltage	110–230 V AC		
Frequency	50–60 Hz		
Installation height	2–3,5 m		
Power consumption	0,1 W		
Setting range brightness	Approx. 5–3000 lx/on		–
Light switch-off delay	Pulse (0,5 s), 10 s–60 min		–
Type of contact light	Relay 230 V / 10 A µ-contact		–
Incandescent/halogen lamp load	2300 W		–
Compact and fluorescent lamps	1150 VA (cos φ = 0,5)		–
Inrush current	max. 800 A / 200 µs		–

Presence and motion detectors/LED spotlights

Presence detectors, 230 V AC



	thePrema S360-101 E UP	thePrema S360-100 E UP	thePrema S360 Slave E UP
Compact and fluorescent lamps (max. number of electronic ballasts)	16 x 54/58 W, 24 x 35/36 W, 8 x 2 x 54/58 W, 12 x 2 x 35/36 W		-
LED lamp < 2 W (typ.)	60 W		-
LED lamp 2–8 W (typ.)	180 W		-
LED lamp > 8 W (typ.)	600 W		-
Switch-on delay presence	0 s–10 min/Room surveillance		-
Presence switch-off delay	10 s–120 min		-
Type of contact presence	Relay potential-free, 220 V DC / 250 V AC		-
Switching capacity presence	50 W/50 VA (max. 2 A), min. 0,5 mV/10 mA		-
Size of concealed housing	Ø 55 mm (NIS, PMI)		
Ambient temperature	0 °C ... +50 °C		
Type of protection	IP 40 (when fitted)		

Detection range (Square)

Mounting height (A)	Walking (T)	Sitting (S)
2 m	20 m² 4,5 m x 4,5 m ± 0,5 m	9 m² 3 m x 3 m
2,5 m	36 m² 6 m x 6 m ± 0,5 m	16 m² 4 m x 4 m
3 m	49 m² 7 m x 7 m ± 1 m	25 m² 5 m x 5 m
3,5 m	64 m² 8 m x 8 m ± 1 m	-

Detection range according to sensNORM IEC 63180 see datasheet

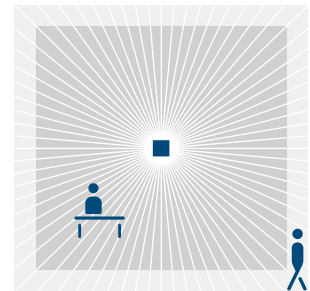
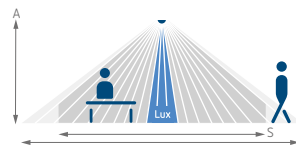

Scale drawings

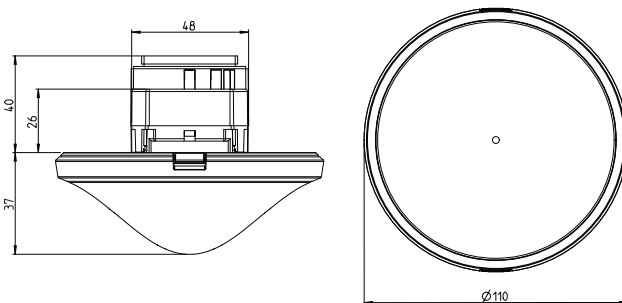

Accessories



theSenda P
↳ Art.No.: 9070910
Details page 359

QuickSafe
Details page 355

theSenda B
Details page 359

theSenda S
Details page 359

Surface frame 110A
Details page 354

Ceiling installation box 68A
Details page 354

Connection diagrams

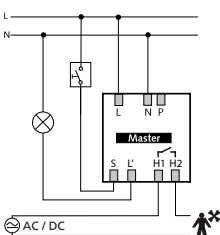

thePrema S360-101 E

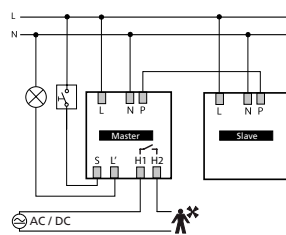

thePrema S360-101 E,
thePrema S360 Slave E

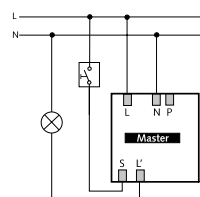

thePrema S360-100 E

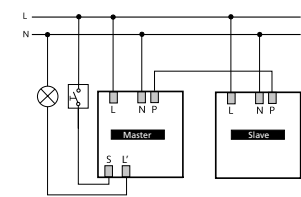

thePrema S360-100 E,
thePrema S360 Slave E

Presence and motion detectors/LED spotlights

Presence detectors, 230 V AC



Description

thePrema P360-101 E

- Passive infrared presence detector for ceiling mounting
- Square detection area 360° (up to 100 m²) for reliable and easy planning
- Automatic presence- and brightness-dependent control for lighting and HVAC
- Mixed light measurement suitable for fluorescent lamps (FL/PL/ESL), halogen/ incandescent lamps and LEDs
- Light measurement can be switched to spot or wide measurement
- Channel A, light: relay, 230 V
- Choice of fully or semi-automatic (absence detection) operation
- Adjustable brightness switching value, teach-in function
- Self-learning time delay
- Reduction of switch-off delay time in the event of short presence (brief-presence)
- Connection option for sensors or switches for manual switching with automatic recognition of sensor/switch
- Pulse function for staircase light time switch
- Channel H, presence: relay, floating e.g. for HVAC control

- Switch-on delay and switch-off delay configurable
 - Room monitoring with selective movement detection
 - Exceptionally easy configuration of the energy-saving behaviour with the new «eco plus» function
 - Staircase time function
 - Operating mode of light and presence relay can be flexibly selected using the remote control theSenda B
 - User remote control theSenda S, management remote control theSenda B (optional)
 - Ready for immediate use due to factory preset
 - Test mode for checking function and detection area
 - Extension of detection area via Master/Slave or Master/Master switching, a maximum of 10 detectors can be switched in parallel with each other
 - Ceiling installation in flush-mounted socket
 - Ceiling installation also possible with surface-mounted frame
- thePrema P360 Slave E**
- Slave version for thePrema
 - Just to be used with thePrema as Master

* According to guarantee conditions, see www.theben.de/en/guarantee

Product selection

Installation type	Channel	Operating voltage	Colour	Type	Article number
Ceiling installation	Light Presence	110–230 V AC	White	thePrema P360-101 E UP WH	2070105
			Grey	thePrema P360-101 E UP GR	2070106
	Slave	110–230 V AC	White	thePrema P360 Slave E UP WH	2070130
			Grey	thePrema P360 Slave E UP GR	2070131

Technical data

	thePrema P360-101 E UP	thePrema P360 Slave E UP
Operating voltage	110–230 V AC	
Frequency	50–60 Hz	
Installation height	2–10 m	
Power consumption	0,1 W	
Setting range brightness	Approx. 5–3000 lx/on	–
Light switch-off delay	Pulse (0,5 s), 10 s–60 min	–
Type of contact light	Relay 230 V/10 A μ-contact	–
Incandescent/halogen lamp load	2300 W	–
Compact and fluorescent lamps	1150 VA (cos φ = 0,5)	–
Inrush current	max. 800 A/200 μs	–
Compact and fluorescent lamps (max. number of electronic ballasts)	16 x 54/58 W, 24 x 35/36 W, 8 x 2 x 54/58 W, 12 x 2 x 35/36 W	–
LED lamp < 2 W (typ.)	60 W	–
LED lamp 2–8 W (typ.)	180 W	–

Presence and motion detectors/LED spotlights

Presence detectors, 230 V AC



	thePrema P360-101 E UP	thePrema P360 Slave E UP
LED lamp > 8 W (typ.)	600 W	-
Switch-on delay presence	0 s – 10 min/Room surveillance	-
Presence switch-off delay	10 s – 120 min	-
Type of contact presence	Relay potential-free, 220 V DC / 250 V AC	-
Switching capacity presence	50 W / 50 VA (max. 2 A), min. 0,5 mV / 10 mA	-
Size of concealed housing	Ø 55 mm (NIS, PMI)	
Ambient temperature	0 °C ... +50 °C	
Type of protection	IP 40 (when fitted)	

Detection range (Square)

Mounting height (A)	Walking (T)	Sitting (S)
2 m	36 m ² 6 m x 6 m ± 0,5 m	20 m ² 4,5 m x 4,5 m
2,5 m	64 m ² 8 m x 8 m ± 0,5 m	36 m ² 6 m x 6 m
3 m	81 m ² 9 m x 9 m ± 1 m	49 m ² 7 m x 7 m
3,5 m	100 m ² 10 m x 10 m ± 1 m	64 m ² 8 m x 8 m
6 m	144 m ² 12 m x 12 m ± 1,5 m	-
10 m	400 m ² 20 m x 20 m ± 2 m	-

With a mounting height of more than 3.5 m walking motions are necessary and the detection areas of several detectors should overlap in the marginal zone. All figures are up to values. The detection range decreases with increasing temperatures.

Detection range according to sensNORM IEC 63180 see datasheet

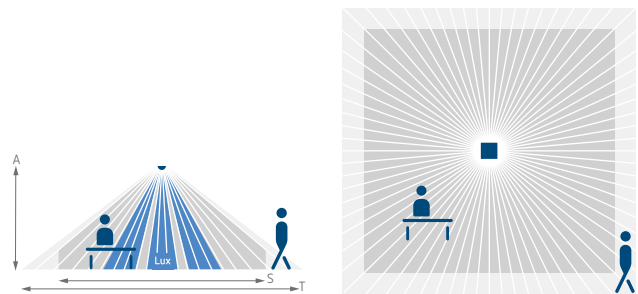

Scale drawings

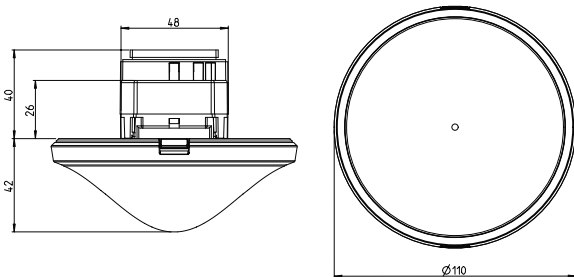

Accessories



theSenda P
↳ Art.No.: 9070910
Details page 359

QuickSafe
Details page 355

theSenda B
Details page 359

theSenda S
Details page 359

Surface frame 110A
Details page 354

Ceiling installation box 68A
Details page 354

Connection diagrams

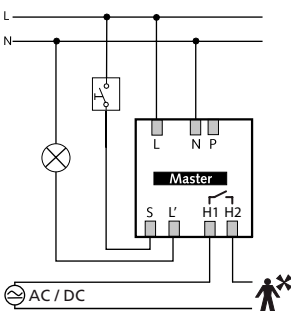

thePrema P360-101 E

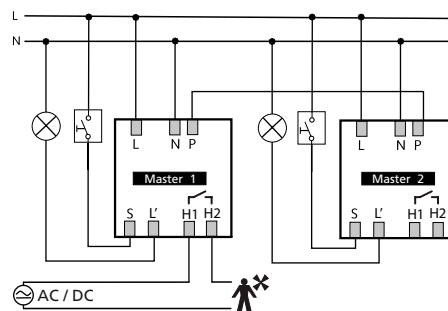

thePrema P360-101 E

Presence and motion detectors/LED spotlights

Presence detectors, 230 V AC



PresenceLight 180

Description

- Presence detector (PIR)
- Automatic control of lighting depending on presence and brightness
- Cover frame in white included in delivery, cover frames in black or silver available as optional accessories
- IP 54 for versatile use
- Light switch output (relay, 230 V)
- Mixed light measurement, suitable for fluorescent lamps (FL/PL/ESL), halogen/ incandescent lamps and LEDs
- Brightness threshold and self-learning switch-off delay adjustable
- Pulse function for staircase time switch
- Parameters can be set using the potentiometers or via the optional service remote controls
- Optional user remote control
- Ready for use by ex-factory set items
- Test operation to check detection area and installation
- Wall mounting in flush-mounted box
- Possibility of surface mounting by using a surface frame

Product selection

Installation type	Channel	Operating voltage	Colour	Type	Article number
Wall installation	Light	230 V AC	Pure white (similar to RAL 9010)	PresenceLight 180	2000050
Further colours with accessory possible					

Technical data

	PresenceLight 180
Operating voltage	230 V AC
Frequency	50 Hz
Installation height	1,7–2,2 m
Power consumption	0,9 W
Setting range brightness	Approx. 10–1500 lx/on
Light switch-off delay	Pulse (0,5 s), 10 s–20 min
Type of contact light	Relay 230 V
Resistive load	1400 W
Incandescent/halogen lamp load	1200 W
Compact and fluorescent lamps	960 VA (cos φ = 0,8), 580 VA (cos φ = 0,5)
Compact and fluorescent lamps (max. number of electronic ballasts)	10 x (1 x 54/58 W), 5 x (2 x 54/58 W), 16 x (1 x 35/36 W), 8 x (2 x 35/36 W), 16 x (smaller than 35/36 W)
LED lamp < 2 W (typ.)	25 W
LED lamp 2–8 W (typ.)	70 W
LED lamp > 8 W (typ.)	80 W
Size of concealed housing	Ø 55 mm (NIS, PMI)
Ambient temperature	–20 °C ... +50 °C
Type of protection	IP 54

Detection range (Semicircular)

Mounting height (A)	Walking (T)	Sitting (S)
2,2 m	100 m² 8 m	25 m² 7 m x 3,5 m

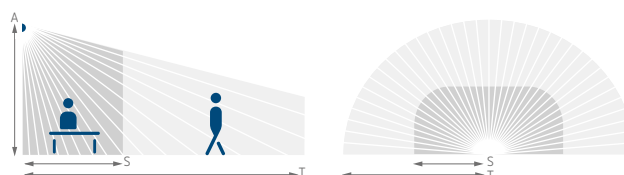

Accessories



Surface frame PresenceLight

↳ Art.No.: 9070513

Details page 354

QuickSafe

Details page 355

Cover frame PresenceLight

180 SR

Details page 354

Cover frame PresenceLight

180 BK

Details page 354

Surface frame PresenceLight BK

Details page 354

Surface frame PresenceLight SR

Details page 354



Scale drawings

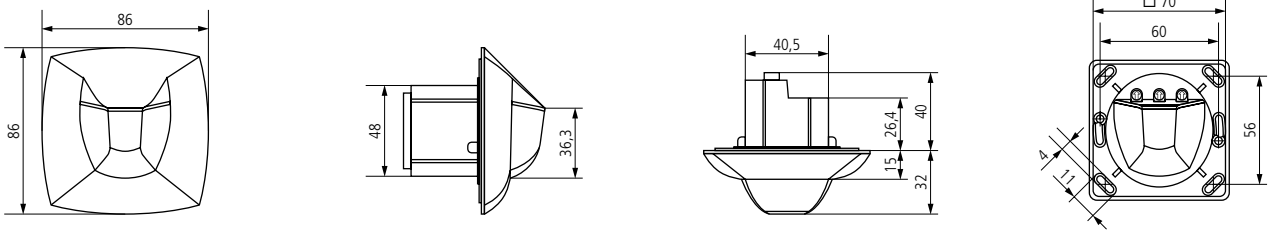

Connection diagrams

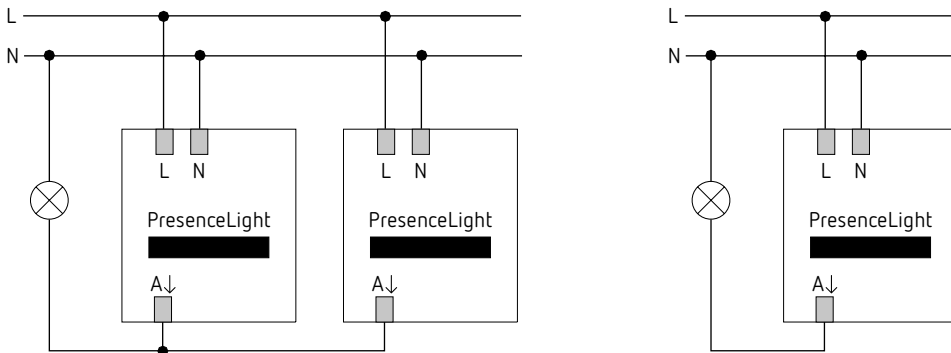

Connection diagrams

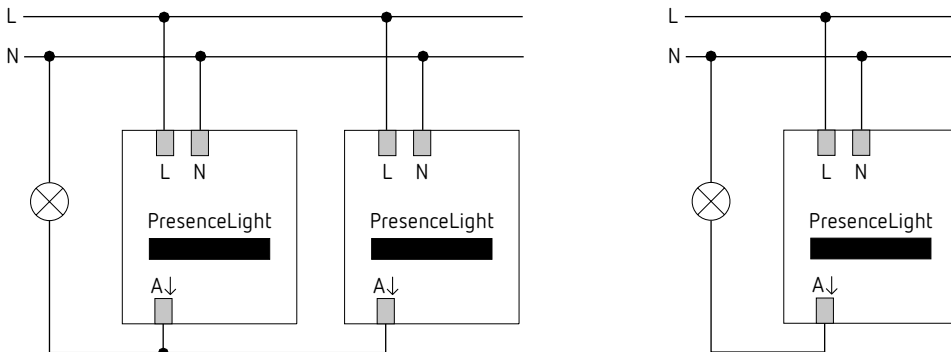

Presence and motion detectors/LED spotlights

Presence / motion detectors 230 V AC



theMura S180-100 UP WH
theMura S180-101 UP WH
theMura S180 Slave UP WH
theMura S180-100 2W UP WH

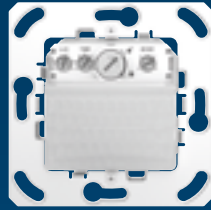

theMura S180-101 B UP
theMura S180-100 B UP

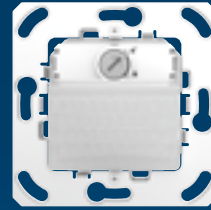

theMura S180 Slave B UP

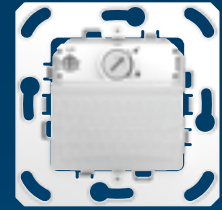

theMura S180-100 2W B UP



Description

Common functions

- Passive infrared motion/presence detector for flush-mounted wall mounting
- Semicircular detection area 170°, up to 14x17 m
- Mixed light measurement suitable for the control of fluorescent, incandescent, halogen lamps and LEDs
- Integrated button (can be blocked)
- Available with Theben frame or without frame
- Adapter frames for common switch ranges available as accessory, see www.theben.de/theMura

theMura S180-100 UP WH (with Theben frame) theMura S180-100 B UP (without frame)

- Motion detector,
- 1 channel light
- Fully or semi-automatic operation
- Adjustable brightness switching value, teach-in function
- Staircase light function
- Switch-on delay configurable
- Extension of detection area via master / slave switching
- Ready for immediate use due to factory presetting

theMura S180-101 UP WH (with Theben frame)

theMura S180-101 B UP (without frame)

- Presence detector
- 1 channel light
- 1 channel presence
- Fully or semi-automatic operation
- External button can be connected
- Adjustable brightness switching value, teach-in function
- Automatic calibration of brightness measurement
- Switch-on delay configurable
- Short-term presence
- Acoustic function
- Orientation light
- Configurable sensitivity
- External button can be connected
- Staircase light function
- Extension of detection area via master / slave switching
- Ready for immediate use due to factory presetting
- Remote operation with theSenda S, theSenda P, theSenda B

theMura S180 Slave UP WH

(with Theben frame)

theMura S180 Slave B UP (without frame)

- Slave version for:
 - theMura S180-100 UP WH
 - theMura S180-100 B UP
 - theMura S180-101 UP WH
 - theMura S180-101 B UP

theMura S180-100 2W UP WH

(with Theben frame)

theMura S180-100 2W B UP (without frame)

- Motion detector
- 1 channel light
- 2-wire version in combination with an ELPA staircase time switch for switching the lamp loads
- Adjustable brightness switching value, teach-in function
- Ideal for replacing existing buttons
- Switch-on delay configurable on the staircase time switch
- Parallel connection possible (up to 12 detectors towards an ELPA)

Product selection

With Theben frame	Channel	Product type	Type	Article number
√	Light	Motion detector	theMura S180-100 UP WH	2060650
	Light Presence	Presence detector	theMura S180-101 UP WH	2060655
	Slave	Motion / presence detector	theMura S180 Slave UP WH	2060660
	Light (In combination with ELPA)	Motion detector	theMura S180-100 2W UP WH	2060670
-	Light	Motion detector	theMura S180-100 B UP	2060750
	Light Presence	Presence detector	theMura S180-101 B UP	2060755
	Slave	Motion / presence detector	theMura S180 Slave B UP	2060760
	Light (In combination with ELPA)	Motion detector	theMura S180-100 2W B UP	2060770

Presence and motion detectors/LED spotlights

Presence/motion detectors 230 V AC



Technical data

	theMura S180-100	theMura S180-101	theMura S180 Slave	theMura S180-100 2W
Operating voltage	230 V AC			
Frequency	50–60 Hz			
Standby output	0.4 W			
Brightness setting range	5–1000 lx	5–3000 lx	–	5–1000 lx
Lighting time delay	10 s – 30 min/pulse	10 s – 60 min/pulse	–	Pulse
Incandescent/halogen lamp load	2300 W			–
LED lamp (typ.)	< 2 W = 40 W > 2 W = 450 W			–
Presence switch-on delay	–	0 s–10 min	–	–
Presence time delay	–	10 s–120 min	–	–
Switching capacity presence	–	50 W / 50 VA	–	–
Ambient temperature	–15 °C ... +45 °C			
Protection rating	IP 20			

Detection area

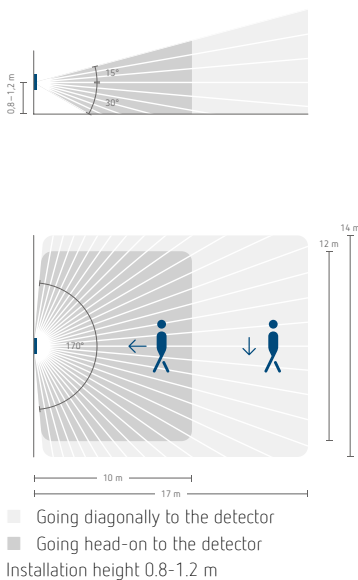

Connection examples

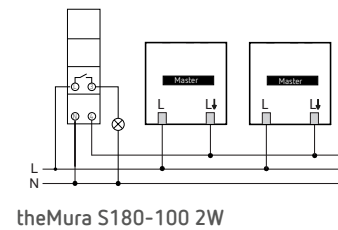
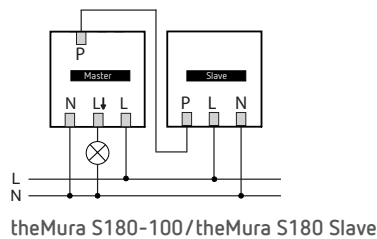
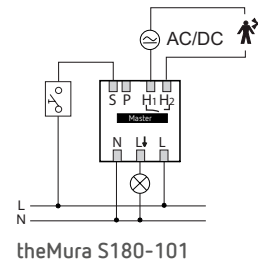
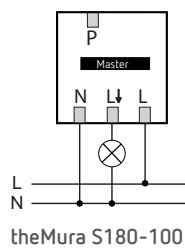

Dimensions

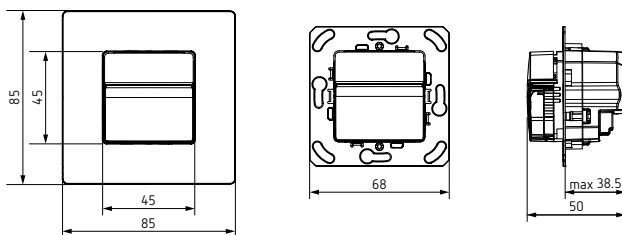

Accessories

theSenda B
Details page 359

theSenda P
Details page 359

theSenda S
Details page 359

Cover frames theMura
Details page 357

Application example

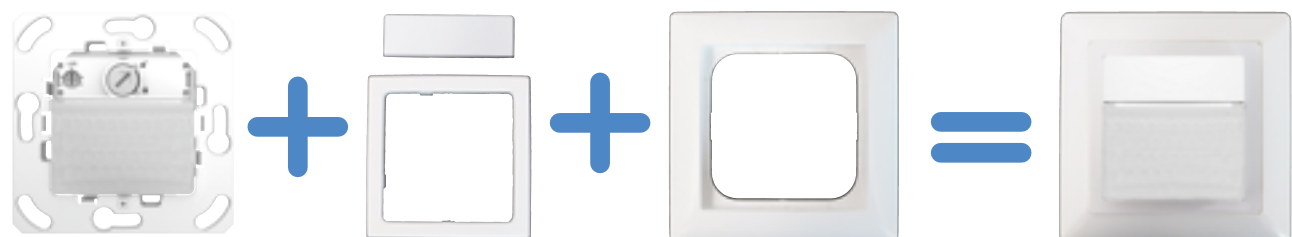

Presence and motion detectors/LED spotlights

Presence detectors, DALI



Description

- Passive infrared presence detector for ceiling mounting
- Square 360° detection range for an accurate and simple planning
- DALI interface in accordance with EN 62386 for max. 25 DALI electronic ballasts
- Automatic allocation of DALI participants (DALI Broadcast)
- Automatic lighting regulation with constant light control
- Mixed light measurement suitable for switching fluorescent lamps (FL/PL), halogen and incandescent lamps as well as LEDs
- Facility to connect a push button for manual dimming and switching (single-button control)
- Fully or semi-automatic operation switch-selectable
- Brightness switching level, self-learning switch-off delay time, stand-by time and stand-by brightness can be adjusted
- Scene component with two built-in scenes
- Ready for immediate use due to factory preset
- Test mode for checking function and detection area
- Extension of detection area via Master/Slave or Master/Master switching, a maximum of 10 detectors can be switched at the same time
- Ceiling installation in flush-mounted socket
- Ceiling installation possible with surface-mounted frame
- User remote control theSenda S (option)
- Service remote control theSenda B (option)

* According to guarantee conditions, see www.theben.de/en/guarantee

Product selection

Installation type	Channel	Operating voltage	Colour	Type	Article number
Ceiling installation	DALI	230 V AC	White	thePrema S360 DALI UP WH	2070525
			Grey	thePrema S360 DALI UP GR	2070526

Technical data

	thePrema S360 DALI UP WH	thePrema S360 DALI UP GR
Operating voltage	230 V AC	
Frequency	50 Hz	
Installation height	2–3,5 m	
Minimum height	> 1,7 m	
Power consumption	0,5 W	
Setting range brightness	5–3000 lx	
Stand-by time light	0 s–60 min/on	
Stand-by brightness	1–25 %	
Control output	50 mA	
Size of concealed housing	Ø 55 mm (NIS, PMI)	
Ambient temperature	0 °C ... +50 °C	
Type of protection	IP 40 (when fitted)	

Detection range (Square)

Mounting height (A)	Walking (T)	Sitting (S)
2 m	20 m ² 4,5 m x 4,5 m ± 0,5 m	9 m ² 3 m x 3 m
2,5 m	36 m ² 6 m x 6 m ± 0,5 m	16 m ² 4 m x 4 m
3 m	49 m ² 7 m x 7 m ± 1 m	25 m ² 5 m x 5 m
3,5 m	64 m ² 8 m x 8 m ± 1 m	-

Detection range according to sensNORM IEC 63180 see datsheet

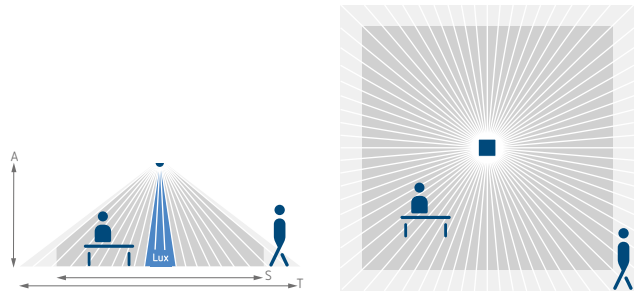

Accessories



Surface frame 110A WH
↳ Art.No.: 9070912
Details page 354



theSenda P
↳ Art.No.: 9070910
Details page 359



theSenda S
↳ Art.No.: 9070911
Details page 359

Surface frame 110A GR
Details page 354

theSenda B
Details page 359

Ceiling installation box 68A
Details page 354

QuickSafe
Details page 355

Scale drawings

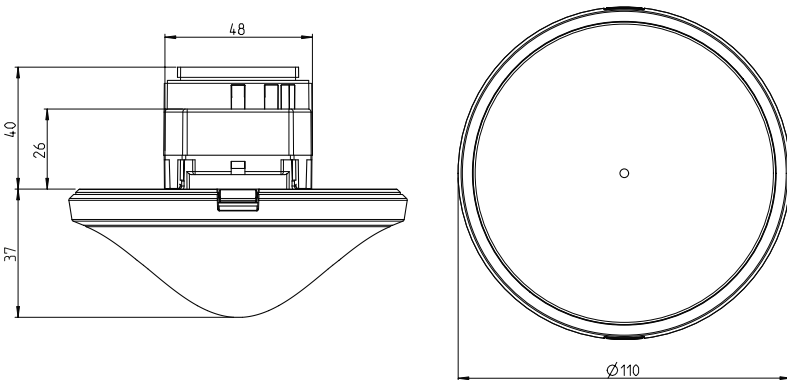

Connection diagrams

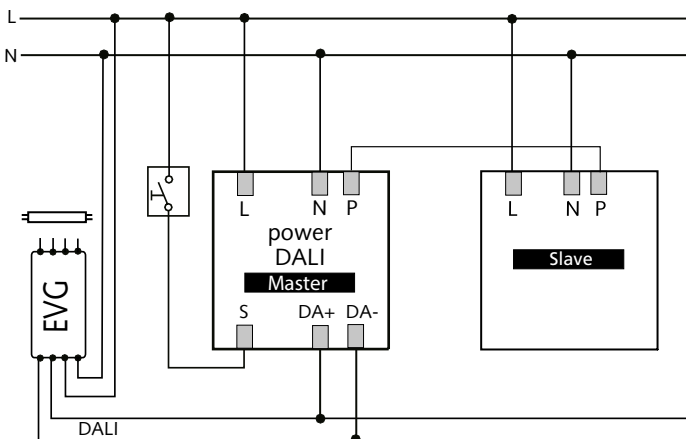

thePrema S360 DALI

thePrema S360 Slave E

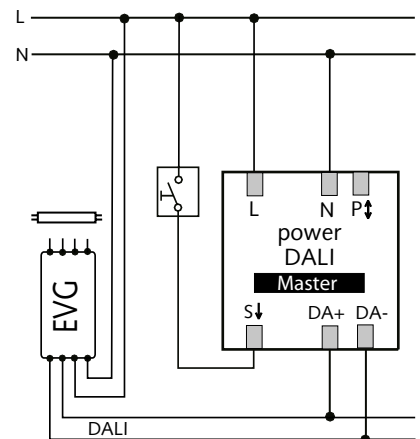

thePrema S360 DALI

Presence and motion detectors/LED spotlights

Presence detectors, DALI-2



Description

- Passive infrared presence detector for ceiling mounting, DALI-2 certified
- Square detection area for corridors and storage areas
- Detection area with 2 individually connectable and disconnectable detection zones, each 15 x 5 m (total 30 x 5 m)
- Up to 2 light channels DALI-2 addressable or 1 light channel DALI-2 in Broadcast mode
- DALI-2 technology according to IEC 62386 Parts 101 and 103
- Flexible assignment of up to 2 light groups towards one DALI line
- Easy, intuitive configuration of the DALI groups
- Up to 2 push-button inputs
- Using of conventional push-buttons for maximum design freedom
- Switch or constant light control mode with stand-by function
- Dimmable lighting in switch mode with stand-by function
- Choice of fully or semi-automatic operation
- Easy integration of an external DALI relay by an additional group e.g. for HVAC applications possible
- Adjustable brightness switching value
- Teach-in function via remote control or push-button
- Setting of room correction factor (Automatic adjustment of brightness measurement)
- Light time delay can be set
- Calibrated 2 channels light measurement
- Brief-presence
- Self-learning time delay
- Extremely easy setting of energy saving characteristics with the new „eco plus“ function
- Selectable control speed
- Manual override via remote control or pushbutton
- Behavior after push button operation selectable (school / office)
- Test mode light
- Test-Mode presence
- Remote-controllable
- Scenes
- Sensitivity adjustable
- Detection area can be limited using cover clip
- Extension of detection area via Master/ Slave or Master/Master switching
- Optimized handling by installer during assembly, wiring, commissioning

Product selection

Installation type	Channel	Operating voltage	Colour	Type	Article number
Ceiling installation	DALI	110–230 V AC	White	thePassa P360-221 DALI UP WH	2010340

Further colours with accessory possible

Technical data

	thePassa P360-221 DALI UP WH
Operating voltage	110–230 V AC
Frequency	50–60 Hz
Installation height	2–15 m
Minimum height	> 1,7 m
Switching output	DALI
Power consumption	≤ 0,4 W
Setting range brightness	10–3000 lx
Stand-by time light	0 s–60 min/on
Stand-by brightness	1–25 %
Control output	100 mA
Output light	DALI-interface according to IEC SN EN 62 386 for max. 64 DALI devices
Size of concealed housing	Ø 55 mm (NIS, PMI)
Ambient temperature	–15 °C ... +50 °C
Type of protection	IP 54 (when fitted)

Presence and motion detectors/LED spotlights

Presence detectors, DALI-2

Detection range (Rectangular)

Mounting height (A)	Head on to (r)	Diagonally (t)
2 m	56 m ² 16 m x 3,5 m	56 m ² 16 m x 3,5 m
2,5 m	72 m ² 18 m x 4 m	88 m ² 22 m x 4 m
3 m	90 m ² 20 m x 4,5 m	135 m ² 30 m x 4,5 m
3,5 m	100 m ² 20 m x 5 m	150 m ² 30 m x 5 m
4 m	100 m ² 20 m x 5 m	150 m ² 30 m x 5 m
4,5 m	100 m ² 20 m x 5 m	150 m ² 30 m x 5 m
5 m	100 m ² 20 m x 5 m	150 m ² 30 m x 5 m
5,5 m	100 m ² 20 m x 5 m	150 m ² 30 m x 5 m
6 m	100 m ² 20 m x 5 m	150 m ² 30 m x 5 m

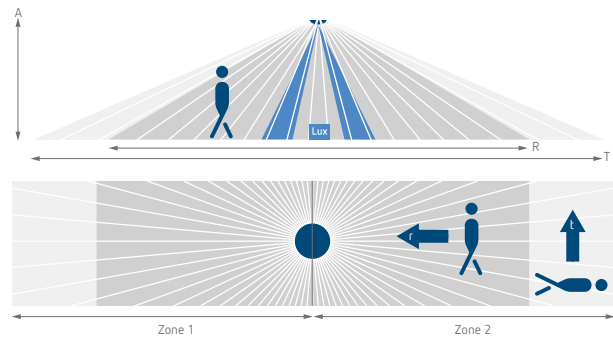

Detection range according to sensNORM IEC 63180 see datasheet

Accessories



theSenda B

↳ Art.No.: 9070985

Details page 359



theSenda P

↳ Art.No.: 9070910

Details page 359



theSenda S

↳ Art.No.: 9070911

Details page 359

QuickSafe

Details page 355

Surface frame 110A WH

Details page 354

Surface frame 110A GR

Details page 354

Ceiling installation box 68A

Details page 354

Masking clip

Details page 355

Cover 110 GR

Details page 355

Scale drawings

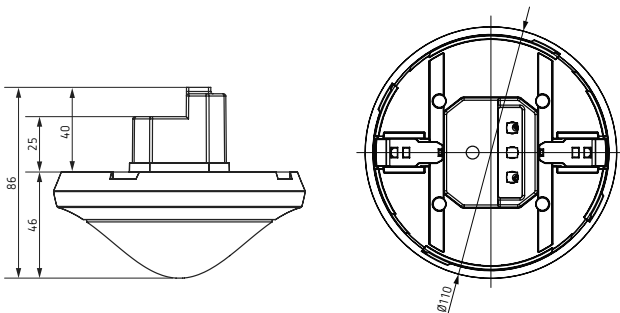

Connection diagrams

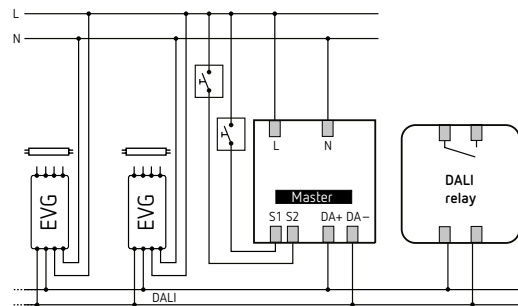

Connection diagrams

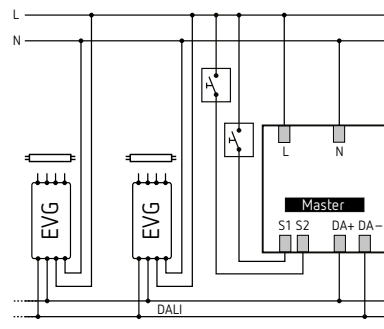
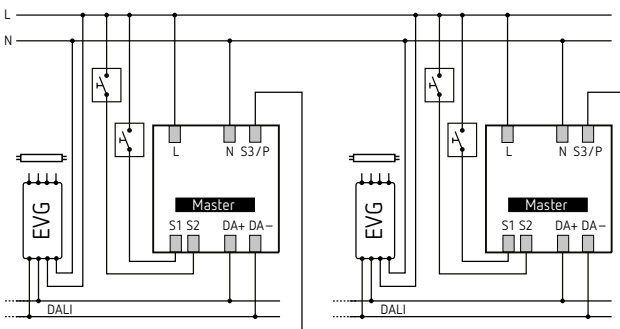

Presence and motion detectors/LED spotlights

Presence detectors, DALI-2

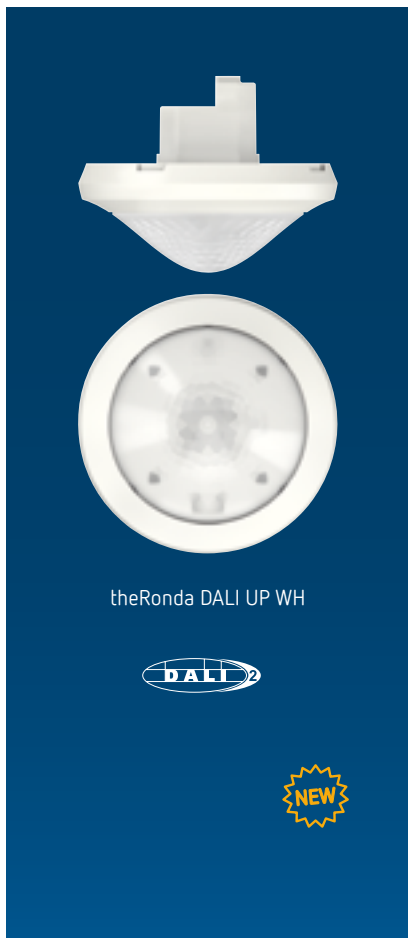

Description

theRonda P360-110 DALI UP,
theRonda S360-110 DALI UP

- Passive infrared presence detector for ceiling mounting, DALI-2 certified
- Round detection area 360°
- 1 light channel DALI-2 broadcast
- DALI-2 technology according to IEC 62386 Parts 101 and 103
- 1 push-button input
- Using of conventional push-buttons for maximum design freedom
- Switch or constant light control mode with stand-by function
- Dimmable lighting in switch mode with stand-by function
- Choice of fully or semi-automatic operation
- Adjustable brightness switching value
- Teach-in function via remote control or push-button
- Setting of room correction factor (Automatic adjustment of brightness measurement)
- Light time delay can be set
- Calibrated 1 channel light measurement
- Brief-presence
- Self-learning time delay
- Extremely easy setting of energy saving characteristics with the new „eco plus“ function

- Selectable control speed
- Manual override via remote control or push-button
- Behavior after push button operation selectable (school / office)
- Test mode light
- Test-Mode presence
- Remote-controllable
- Scenes
- Sensitivity adjustable
- Detection area can be limited using cover clip
- Extension of detection area via Master/ Slave or Master/Master switching
- Optimized handling by installer during assembly, wiring, commissioning

theRonda P360-330 DALI UP

As theRonda S360-110 & P360-110, but:

- Flexible assignment of up to 3 light groups towards one DALI line
- Easy, intuitive configuration of the DALI groups
- Up to 3 push-button inputs
- Flexible assignment of the push-buttons to the desired light channel using remote control
- Calibrated 3 channels light measurement

Product selection

Installation type	Channel	Detection range	Colour	Type	Article number
Ceiling installation	3 channels addressable	Ø 24 m	White	theRonda P360-330 DALI UP WH	2080045
	1 channel Broadcast	Ø 24 m	White	theRonda P360-110 DALI UP WH	2080040
	1 channel Broadcast	Ø 8 m	White	theRonda S360-110 DALI UP WH	2080580

Further colours with accessory possible

Technical data

	theRonda P360-330 DALI UP	theRonda P360-110 DALI UP	theRonda S360-110 DALI UP
Operating voltage	110–230 V AC		
Frequency	50–60 Hz		
Installation height	2–15 m		2–4 m
Minimum height	> 1,7 m		
Power consumption	0,3 W		
Setting range brightness	10–3000 lx / measurement off		
Light switch-off delay	10 s–60 min		
Stand-by time light	0 s–60 min/on		
Stand-by brightness	1–25 %		
Control output	100 mA		
Size of concealed housing	Ø 55 mm (NIS, PMI)		
Ambient temperature	–15 °C ... +50 °C		
Type of protection	IP 54 (when fitted)		

Detection range theRonda P (Round)

Mounting height (A)	Sitting (S)	Walking diagonally (T)	Walking head on to (R)
2 m	16 m ² 4,5 m	380 m ² 22 m	28 m ² 6 m
2,5 m	24 m ² 5,5 m	415 m ² 23 m	38 m ² 7 m
3 m	28 m ² 6 m	452 m ² 24 m	50 m ² 8 m
3,5 m	38 m ² 7 m	452 m ² 24 m	50 m ² 8 m
6 m	-	452 m ² 24 m	50 m ² 8 m
10 m	-	491 m ² 25 m	50 m ² 8 m

With a mounting height of more than 3.5 m walking motions are necessary and the detection areas of several detectors should overlap in the marginal zone. All figures are up to values. The detection range decreases with increasing temperatures.

Detection range according to sensNORM IEC 63180 see datsheet

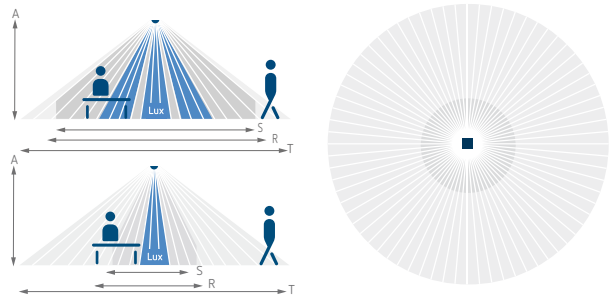

Detection range theRonda S (Round)

Mounting height (A)	Sitting (S)	Walking diagonally (T)	Walking head on to (R)
2 m	5 m ² 2,5 m	5 m ² 2,5 m	38 m ² 7 m
2,5 m	7 m ² 3 m	7 m ² 3 m	38 m ² 7 m
3 m	13 m ² 4 m	13 m ² 4 m	50 m ² 8 m
3,5 m	-	13 m ² 4 m	50 m ² 8 m
4 m	-	13 m ² 4 m	64 m ² 9 m

Detection range according to sensNORM IEC 63180 see datsheet

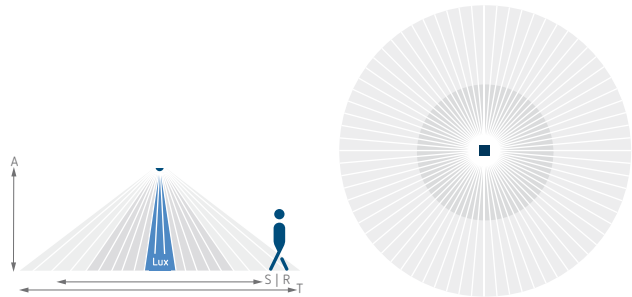

Accessories



theSenda B
↳ Art.No.: 9070985
Details page 359

Surface frame 110A
Details page 354

theSenda S/P
Details page 359

Ceiling installation box 68A
Details page 354

Masking clip
Details page 355

QuickSafe
Details page 355

Cover 110 GR
Details page 355

Scale drawings

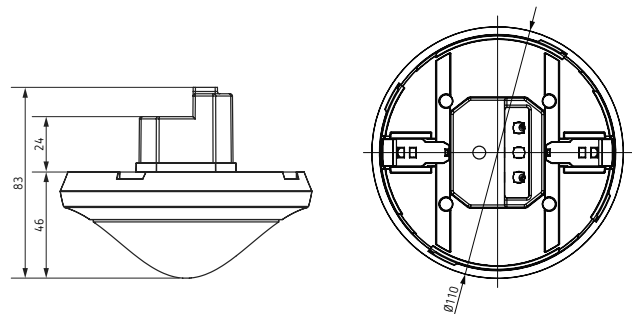

Connection diagrams

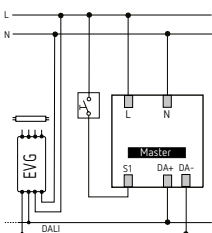

theRonda S360-110 DALI UP,
theRonda P360-110 DALI UP,

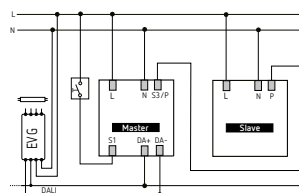

theRonda S360-110 DALI UP,
theRonda P360-110 DALI UP,

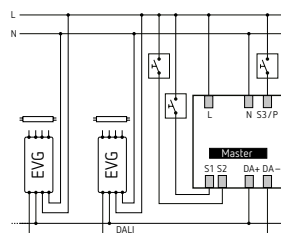

theRonda P360-330 DALI UP

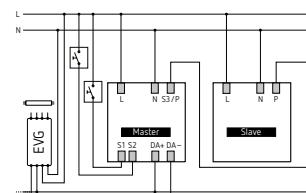

theRonda P360-330 DALI UP

Presence and motion detectors/LED spotlights

Presence sensors, DALI-2

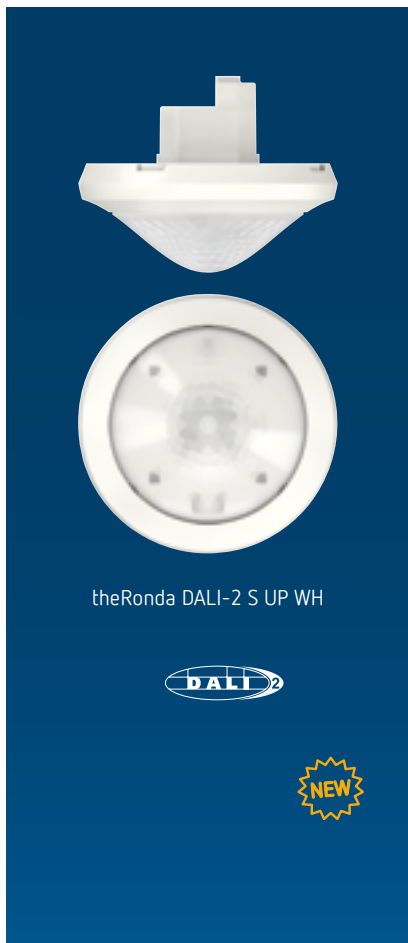

Description

- Passive infrared presence sensor for ceiling installation, DALI-2 certified
- This device provides information about presence and brightness in the form of a DALI telegram in line with IEC 62386 Part 303/304
- Easy to calibrate brightness measurement
- Test mode for checking function and detection area
- Configurable detection sensitivity
- Can be configured via DALI bus or remote control
- The "theSenda S" or "theSenda B" user remote controls can be used to dim or switch the lamps, to control the blinds or to execute additional functions via the higher-level control system.
- Ceiling installation in flush-mounted box
- Surface mounting on ceilings possible with 110A back box (option)
- Area restriction with cover clips (optional)
- "theSenda B" app remote control (optional) and corresponding "theSenda Plug" app (for iOS/Android)
- A Multi-Master Application Controller is required for start-up/control and configuration. It must be in accordance with IEC 62386 Parts 101/103 and, optionally, 301/303/304

theRonda P360 DALI-2 S UP WH

- Circular detection area 360°, up to Ø 25 m (491 m²)
- 3-way mixed light measurement, suitable for fluorescent lamps (FL/PL/ESL), halogen/incandescent lamps and LEDs
- 1 instance for presence
- 4 instances for brightness – integral/interior/centre/window

theRonda S360 DALI-2 S UP WH

- Circular detection area 360°, up to Ø 9 m (64 m²)
- 1-way mixed light measurement, suitable for fluorescent lamps (FL/PL/ESL), halogen/incandescent lamps and LEDs
- 1 instance for presence
- 1 instance for brightness

Product selection

Type of installation	Channel	Colour	Type	Article number
Ceiling installation	DALI-2 sensor	White	theRonda P360 DALI-2 S UP WH	2080090
Ceiling installation	DALI-2 sensor	White	theRonda S360 DALI-2 S UP WH	2080590
Other colours available with accessories				

Technical data

	theRonda P360 DALI-2 S UP WH	theRonda S360 DALI-2 S UP WH
Operating voltage	DALI (in accordance with IEC 62386-101): 10 V–22.5 V	
Power consumption	Max. 10 mA	
Installation height	2–15 m	2–4 m
Minimum height	> 1.7 m	
Brightness measurement range	10–10,000 lx	
Ambient temperature	-15 °C to +50 °C	
Protection rating	IP 54 (installed)	

Detection range theRonda P (Round)

Mounting height (A)	Sitting (S)	Walking diagonally (T)	Walking head on to (R)
2 m	16 m ² 4,5 m	380 m ² 22 m	28 m ² 6 m
2,5 m	24 m ² 5,5 m	415 m ² 23 m	38 m ² 7 m
3 m	28 m ² 6 m	452 m ² 24 m	50 m ² 8 m
3,5 m	38 m ² 7 m	452 m ² 24 m	50 m ² 8 m
6 m	-	452 m ² 24 m	50 m ² 8 m
10 m	-	491 m ² 25 m	50 m ² 8 m

With a mounting height of more than 3.5 m walking motions are necessary and the detection areas of several detectors should overlap in the marginal zone. All figures are up to values. The detection range decreases with increasing temperatures.

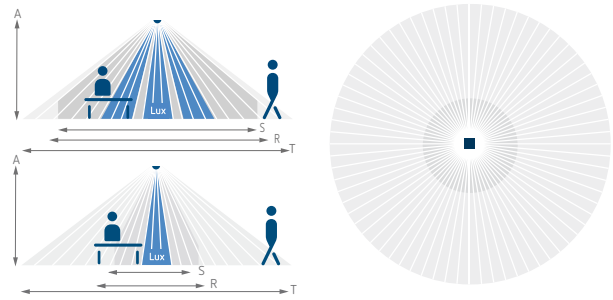

Detection range theRonda S (Round)

Mounting height (A)	Sitting (S)	Walking diagonally (T)	Walking head on to (R)
2 m	5 m ² 2,5 m	5 m ² 2,5 m	38 m ² 7 m
2,5 m	7 m ² 3 m	7 m ² 3 m	38 m ² 7 m
3 m	13 m ² 4 m	13 m ² 4 m	50 m ² 8 m
3,5 m	-	13 m ² 4 m	50 m ² 8 m
4 m	-	13 m ² 4 m	64 m ² 9 m

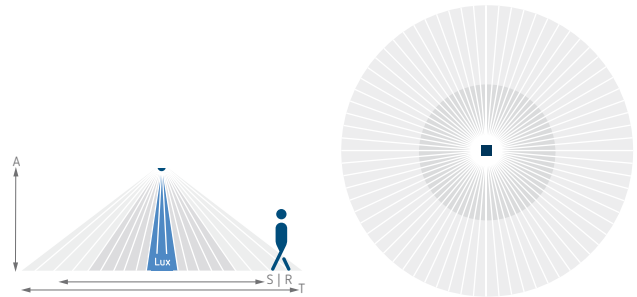

Accessories



theSenda B

↳ Art.No.: 9070985
Details page 359



theSenda P

↳ Art.No.: 9070910
Details page 359



theSenda S

↳ Art.No.: 9070911
Details page 359

QuickSafe

Details page 355

Surface frame 110A WH

Details page 354

Surface frame 110A GR

Details page 354

Ceiling installation box 68A

Details page 354

Masking clip

Details page 355

Cover 110 GR

Details page 355

Scale drawings

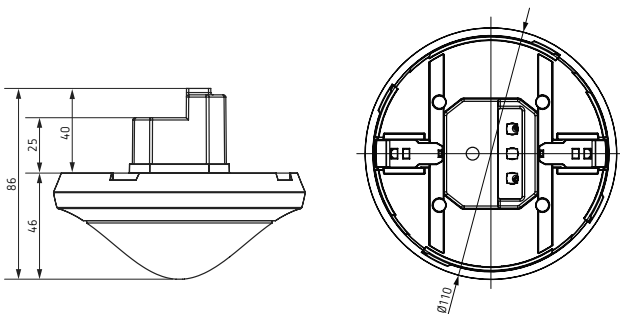

Presence and motion detectors/LED spotlights

Presence sensors, DALI-2



Description

- Passive infrared presence sensor for ceiling installation, DALI-2 certified
- This device provides information about presence and brightness in the form of a DALI telegram in line with IEC 62386 Part 303/304
- Rectangular detection area 360°, up to 30 x 5 m (150 m²), for reliable and easy planning
- 3 instances for presence – detection area zone 1 + 2/zone 1/zone 2
- 2-way mixed light measurement, suitable for fluorescent lamps (FL/PL/ESL), halogen/ incandescent lamps and LEDs
- 3 instances for brightness – detection area zone 1 + 2/zone 1/zone 2
- Easy to calibrate brightness measurement
- Test mode for checking function and detection area
- Configurable detection sensitivity
- Can be configured via DALI bus or remote control
- The "theSenda S" or "theSenda B" user remote controls can be used to dim or switch the lamps, to control the blinds or to execute additional functions via the higher-level control system.
- Ceiling installation in flush-mounted box
- Surface mounting on ceilings possible with 110A back box (option)
- Area restriction with cover clips (optional)
- "theSenda B" app remote control (optional) and corresponding "theSenda Plug" app (for iOS/Android)
- A Multi-Master Application Controller is required for start-up/control and configuration. It must be in accordance with IEC 62386 Parts 101/103 and, optionally, 301/303/304

Product selection

Type of installation	Channel	Colour	Type	Article number
Ceiling installation	DALI-2 sensor	White	thePassa P360 DALI-2 S UP WH	2010390
Other colours available with accessories				

Technical data

	thePassa P360 DALI-2 S UP WH
Operating voltage	DALI (in accordance with IEC 62386-101): 10 V–22.5 V
Power consumption	Max. 10 mA
Installation height	2–15 m
Minimum height	> 1.7 m
Brightness measurement range	10–10,000 lx
Ambient temperature	-15 °C to +50 °C
Protection rating	IP 54 (installed)

Presence and motion detectors/LED spotlights

Presence sensors, DALI-2

Detection area (rectangular)

Installation height (A)	Head on to (R)	Transverse (T)
2 m	56 m ² 16 x 3.5 m	56 m ² 16 x 3.5 m
2.5 m	72 m ² 18 x 4 m	88 m ² 22 x 4 m
3 m	90 m ² 20 x 4.5 m	135 m ² 30 x 4.5 m
3.5 m	100 m ² 20 x 5 m	150 m ² 30 x 5 m
4 m	100 m ² 20 x 5 m	150 m ² 30 x 5 m
4.5 m	100 m ² 20 x 5 m	150 m ² 30 x 5 m
5 m	100 m ² 20 x 5 m	150 m ² 30 x 5 m
5.5 m	100 m ² 20 x 5 m	150 m ² 30 x 5 m
6 m	100 m ² 20 x 5 m	150 m ² 30 x 5 m

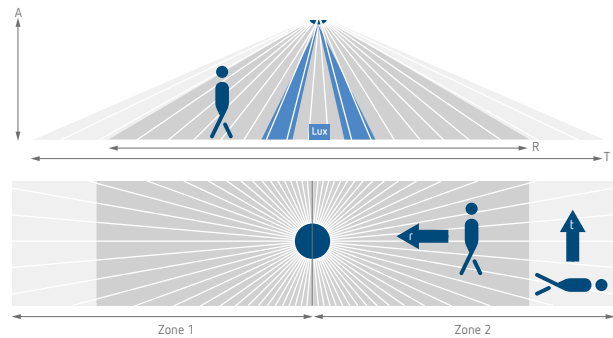

Accessories



theSenda B

↳ Art.No.: 9070985

Details page 359



theSenda P

↳ Art.No.: 9070910

Details page 359



theSenda S

↳ Art.No.: 9070911

Details page 359

QuickSafe

Details page 355

Surface frame 110A WH

Details page 354

Surface frame 110A GR

Details page 354

Ceiling installation box 68A

Details page 354

Masking clip

Details page 355

Cover 110 GR

Details page 355

Scale drawings

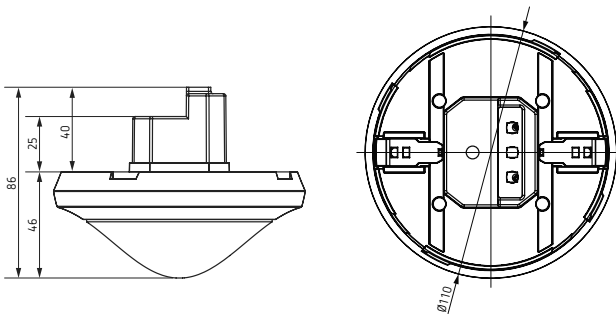

Presence and motion detectors/LED spotlights

Presence sensors, DALI-2



Description

- Passive infrared presence sensor for ceiling installation, DALI-2 certified
- This device provides information about presence and brightness in the form of a DALI telegram in line with IEC 62386 Part 303/304
- Square detection area 360°, up to 8 x 8 m (64 m²), for reliable and easy planning
- 2 instances for presence
- Standard/reduced detection zone
- Optics can be tilted to adjust the detection area
- 3-way mixed light measurement, suitable for fluorescent lamps (FL/PL/ESL), halogen/incandescent lamps and LEDs
- 4 instances for brightness - interior/centre/window/integral
- Easy to calibrate brightness measurement
- Test mode for checking function and detection area
- Configurable detection sensitivity
- Can be configured via DALI bus or remote control
- The „theSenda S“ or „theSenda B“ user remote controls can be used to dim or switch the lamps, to control the blinds or to execute additional functions via the higher-level control system.
- Flat design with interchangeable bezel frame in different colours
- Ceiling installation in flush-mounted box
- Surface mounting on ceilings possible with surface frame 75B (option)
- Area restriction with cover clips (optional)
- „theSenda B“ app remote control (optional) and corresponding „theSenda Plug“ app (for iOS/Android)
- A Multi-Master Application Controller is required for start-up/control and configuration. It must be in accordance with IEC 62386 Parts 101/103 and, optionally, 301/303/304

Product selection

Installation type	Colour	Type	Article number
Ceiling installation	White	PlanoSpot 360 DALI-2 S DE WH	2030190

Technical data

	<i>PlanoSpot 360 DALI-2 S DE WH</i>
Operating voltage	DALI (in accordance with IEC 62386-101): 10 V–22.5 V
Power consumption	Max. 10 mA
Installation height	2–3.5 m
Minimum height	> 1.7 m
Brightness measurement range	10–10,000 lx
Ambient temperature	0 °C to +50 °C
Protection rating	IP 20

Detection range (Square)

Detection zone standard		
Mounting height (A)	Sitting (S)	Walking (T)
2 m	9 m ² 3 m x 3 m	20 m ² 4,5 m x 4,5 m ± 0,5 m
2,5 m	16 m ² 4 m x 4 m	36 m ² 6 m x 6 m ± 0,5 m
3 m	20 m ² 4,5 m x 4,5 m	49 m ² 7 m x 7 m ± 1 m
3,5 m	–	64 m ² 8 m x 8 m ± 1 m

Detection zone reduced		
Mounting height (A)	Sitting (S)	Walking (T)
2 m	4 m ² 2 m x 2 m	4,4 m ² 2,1 m x 2,1 m ± 0,5 m
2,5 m	6,3 m ² 2,5 m x 2,5 m	9 m ² 3 m x 3 m ± 0,5 m
3 m	9 m ² 3 m x 3 m	14,4 m ² 3,8 m x 3,8 m ± 1 m
3,5 m	–	22,1 m ² 4,7 m x 4,7 m ± 1 m

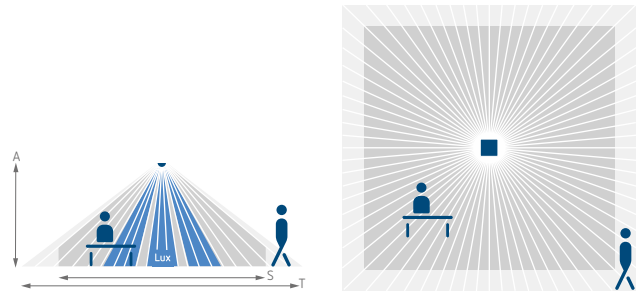

Accessories



Surface frame 75B WH

Details page 355

PlanoCover 76 BK

Details page 355

PlanoCover 76 SR

Details page 355

theSenda B

↳ Art.No.: 9070985

Details page 359

Scale drawings

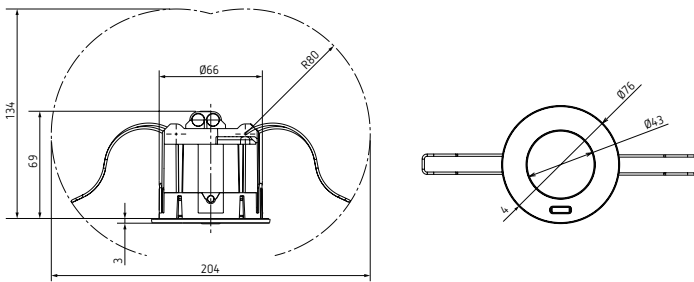

Presence and motion detectors/LED spotlights

Presence detectors KNX



Description

Common functions

- KNX Passive infrared presence detector for ceiling mounting
- Square detection range of 360° for safe and easy planning
- Mixed light measurement suitable for LEDs, fluorescent lamps (FL/PL/ESL) and halogen/incandescent lamps
- Can be used as fully or semi-automatic, switchable
- Switch or constant light control mode with stand-by function
- Dimmable lighting in switch mode with stand-by function
- Brightness switching value or set point value can be set in lux using parameters, on the device itself or via remote control
- Teaching in of the brightness switching value or the set point value

- Room correction factor setting for brightness measurement calibration
- Light time delay can be set using parameters, on the device itself or via remote control
- Switch on delay and time delay for presence can be set
- Detection sensitivity can be set
- Self-learning time delay
- Reduced time delay in the event of a shorter stay in the room (short presence)
- Scenario functions
- Extremely easy setting of energy saving characteristics with the new „eco plus“ function
- Test mode for checking function and detection range
- Parallel switching of several detectors in Master/Slave or Master/Master possible

- User remote control and management-remote control (optional)
 - Room monitoring
- thePrema P360 KNX UP**
- 3 channels light and 2 channels presence
 - 2 channels light C1, C2 with 2 light measurements and additional lighting channel C3 without brightness factor
 - 2 presence channels can be set individually
 - Adaptable 3 channels light measurement
- thePrema S360 KNX UP**
- 2 channels light and 2 channels presence
 - 2 channels light C1, C2 with 1 light measurement
 - 2 presence channels can be set individually with parallel offset
 - Adaptable 1 channel light measurement

* According to warranty terms and conditions, see www.theben.de/en/guarantee

Product selection

Channels	Colour	Type	Article number
3x light/2x presence	White	thePrema P360 KNX UP WH	2079000
	Grey	thePrema P360 KNX UP GR	2079001
2x light/ 2x presence	White	thePrema S360 KNX UP WH	2079500
	Grey	thePrema S360 KNX UP GR	2079501

Technical data

	thePrema P360 KNX UP	thePrema S360 KNX UP
Operating voltage KNX	Bus voltage, approx. 9 mA (13 mA LED on)	Bus voltage, approx. 8 mA (12 mA LED on)
Installation height	2–10 m	2–3,5 m
Setting range brightness	approx. 5–3000 lx/measuring off	
Light switch-off delay	30 s–60 min	
Stand-by dimming value	1–25 % of the lamp output	
Stand-by time	30 s–60 min/inactive/permanently on	

Presence and motion detectors/LED spotlights

Presence detectors KNX

	thePrema P360 KNX UP	thePrema S360 KNX UP
Presence switch-off delay	10 s – 120 min	
Presence switch-on delay	10 s – 30 min/inactive	
Ambient temperature	0 °C ... +50 °C	
Type of protection	IP 40 (when fitted)	

Detection range thePrema P360 KNX (Square)

Mounting height (A)	Walking (T)	Sitting (S)
2 m	36 m ² 6 m x 6 m ± 0,5 m	20 m ² 4,5 m x 4,5 m
2,5 m	64 m ² 8 m x 8 m ± 0,5 m	36 m ² 6 m x 6 m
3 m	81 m ² 9 m x 9 m ± 1 m	49 m ² 7 m x 7 m
3,5 m	100 m ² 10 m x 10 m ± 1 m	64 m ² 8 m x 8 m
6 m	144 m ² 12 m x 12 m ± 1,5 m	–
10 m	400 m ² 20 m x 20 m ± 2 m	–

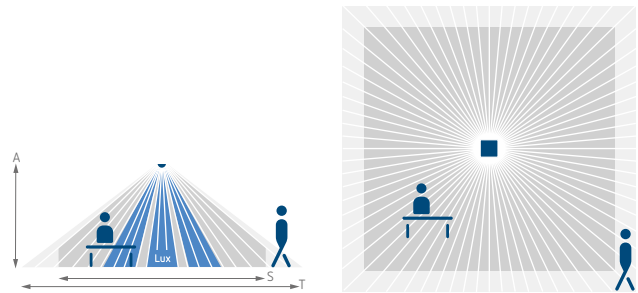

Detection range thePrema S360 KNX (Square)

Mounting height (A)	Walking (T)	Sitting (S)
2 m	20 m ² 4 m x 4 m ± 0,5 m	9 m ² 3 m x 3 m
2,5 m	36 m ² 6 m x 6 m ± 0,5 m	16 m ² 4 m x 4 m
3 m	49 m ² 7 m x 8 m ± 1 m	25 m ² 5 m x 5 m
3,5 m	64 m ² 8 m x 8 m ± 1 m	–

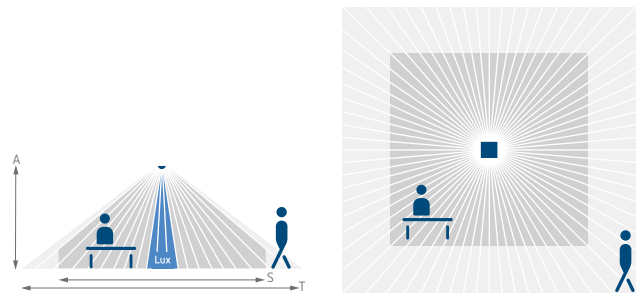

Accessories



Surface frame 110B WH
↳ Art.No.: 9070918
Details page 354



theSenda P
↳ Art.No.: 9070910
Details page 359



theSenda S
↳ Art.No.: 9070911
Details page 359

QuickSafe
Details page 355

theSenda B
Details page 359

Ceiling installation box 68A
Details page 354

Surface frame 110B GR
Details page 354

Scale drawings

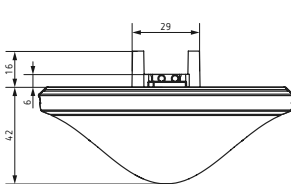

thePrema P360 KNX

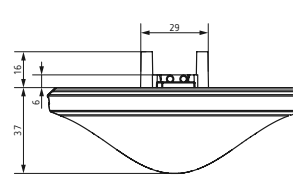
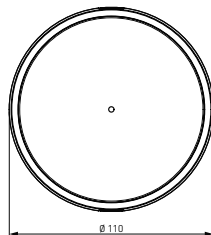

thePrema S360 KNX

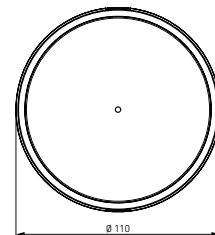

Presence and motion detectors/LED spotlights

Presence detectors KNX



Description

- KNX multisensor
 - Consisting of KNX passive infrared presence detector and room air sensor (= 2 bus sharing units)
- Room air sensor functions**
- Measures CO₂ concentration, relative humidity, temperature and air pressure
 - Three independent, configurable thresholds for CO₂ concentration and relative humidity
 - Integrated room thermostat
 - 4 binary inputs
- Presence detector functions**
- Automatic presence and brightness-dependent control for lighting and HVAC
 - Square detection area 360°, up to 10 x 10 m (100 m²), for reliable and easy planning
 - 2 light channels C1, C2 with 2 light measurements and additional lighting channel C3 without influence of brightness
 - 2 presence channels C4, C5 can be programmed individually
 - Adaptable 3-channel light measurement
 - Mixed light measurement suitable for LEDs, fluorescent lamps (FL/PL/ESL), halogen and incandescent lamps
 - Operation as fully or semi-automatic device, switchable
 - Switching operation or constant light control with standby function (orientation light)
 - Lighting dimmable in switching mode with standby function
- Brightness switching value or set point value configurable in lux using parameters, object or remote control
 - Teach-in of the brightness switching value or set point value
 - Setting of the room correction factor for brightness measurement calibration
 - Light time delay configurable using parameters, object or remote control
 - Configurable switch-on delay and presence time delay
 - Configurable detection sensitivity
 - Self-learning time delay
 - Reduced time delay in the event of short presence
 - Room monitoring function with reduced sensitivity only for detection of walking persons
 - Scene functionality
 - Extremely simple adjustment of energy saving behaviour with "eco plus" function
 - Test mode for checking function and detection area
 - Parallel switching of multiple presence detectors (master/slave or master/master)
 - Room monitoring
 - Remote operation with the following remote controls:
 - theSenda B app remote control
 - theSenda P service remote control
 - theSenda S user remote control

Product selection

Product type	Type	Article number
KNX multisensor (complete device)	thePrema P360 KNX AP Multi WH	2079900
KNX multisensor retrofit set (room air sensor only) for combining with existing KNX detector thePrema S/P KNX UP WH	Set basic KNX AP Multi WH	9070900

Technical data

	thePrema P360 KNX AP Multi WH	Set basic KNX AP Multi WH
KNX operating voltage	Bus voltage, approx. 24 mA (28 mA with LED switched on)	Bus voltage, max. 15 mA
Installation height	2 – 10 m	
Brightness setting range	5 – 3000 lx, on	–
Lighting time delay	30 s – 60 min	–
Standby dimming value	1 – 25% of the lamp output	–
Standby time	30 s – 60 min / not active / permanently on	–
Presence time delay	10 s – 120 min	–
Presence switch-on delay	10 s – 30 min / not active	–
CO ₂ measurement range	300 – 5000 ppm	
Temperature measurement range	–5 °C to +45 °C	
Humidity measurement range	1 – 100% rh	
Air pressure	30,000 – 110,000 Pa	
Ambient temperature	5 °C to +40 °C	
Interface extension max.	30 m	
Protection rating	IP 20	

Detection area (square)

Installation height (A)	Seated (S)	Transverse (T)
2 m	20 m ² 4.5 x 4.5 m	36 m ² 6 x 6 m ± 0.5 m
2.5 m	36 m ² 6 x 6 m	64 m ² 8 x 8 m ± 0.5 m
3 m	49 m ² 7 x 7 m	81 m ² 9 x 9 m ± 1 m
3.5 m	64 m ² 8 x 8 m	100 m ² 10 x 10 m ± 1 m
6 m	–	144 m ² 12 x 12 m ± 1.5 m
10 m	–	400 m ² 20 x 20 m ± 2 m

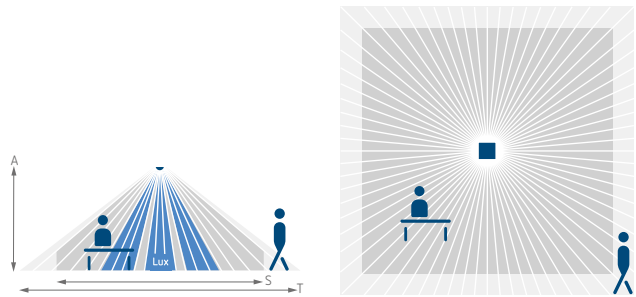

Accessories



theSenda P
↳ Art.No.: 9070910
Details page 359



theSenda S
↳ Art.No.: 9070911
Details page 359

QuickSafe
Details page 355

theSenda B
Details page 359

Ceiling installation box 68A
Details page 354

Scale drawings

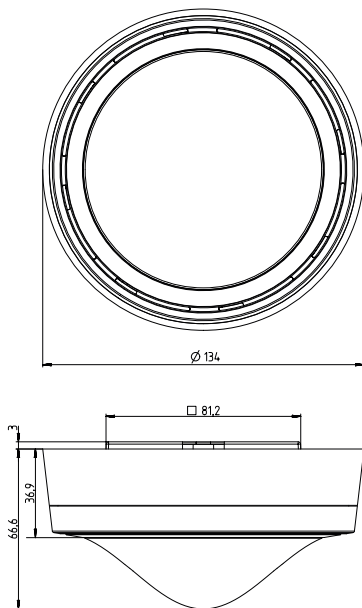

thePrema P360 KNX AP Multi WH

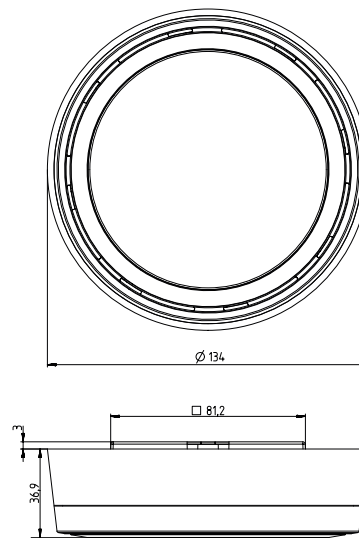

Set basic KNX AP Multi WH

Presence and motion detectors/LED spotlights

Presence detectors KNX



Description

PlanoSpot 360 KNX DE WH

- Passive infrared presence detector for ceiling installation
- Flat design, cover frame in white included in delivery
- Square detection area 360° (up to 64 m²) for reliable and easy planning
- Automatic presence- and brightness-dependent control for lighting and HVAC
- Two differently sized detection zones for greater flexibility. Adjustable via parameters or remote control.
- Manual alignment of the detection area (swivel mechanism)
- Mixed light measurement suitable for fluorescent lamps (FL/PL/ESL), halogen/ incandescent lamps and LEDs
- 3 directed light measurements
- 2 light channels C1, C2 with 2 light measurements and additional lighting channel C3 without brightness factor
- Switched or constant light control with 2 independent control systems and standby function (orientation light)
- Switching mode with dimmable lighting
- Fully or semi-automatic
- Brightness switching value or set point value can be set in lux by using parameters, the object or via remote control
- Teach-in of the brightness switching value or the set point value
- Light time delay configurable
- Self-learning time delay can be set using parameters, object or via remote control
- Reduction of time delay when present briefly (short-term presence)
- Manual override by telegram or remote control
- 2 presence channels C4, C5, individually configurable
- Switch-on delay and time delay configurable
- Room monitoring with selective movement detection
- Setting the room correction factor for brightness measurement comparison
- Configurable sensitivity
- Extremely simple setting of the energy-saving ratio with the new «eco plus» function
- Test mode for checking function and detection area
- Scenarios
- Parallel switching of multiple presence detectors (Master/Slave or Master/Master)
- Installation in false ceilings with springs
- Surface mounting on ceilings possible with surface frame (optional)
- User remote control «theSenda S» (optional)
- Management remote control «theSenda B» (optional)
- Installation remote control «theSenda P» (optional)

Product selection

Swivel mechanism	Colour	Type	Article number
√	Pure white (similar to RAL 9010)	PlanoSpot 360 KNX DE WH	2039100

Technical data

	PlanoSpot 360 KNX DE
Operating voltage KNX	Bus voltage, approx. 8 mA (9 mA LED on)
Installation height	2–3,5 m
Setting range brightness	approx. 10–3000 lx/measuring off
Light switch-off delay	30 s–60 min
Stand-by dimming value	1–25 % of the lamp output
Stand-by time	30 s–60 min/on/inactive
Presence switch-off delay	10 s–120 min
Presence switch-on delay	10 s–30 min/inactive
Ambient temperature	0 °C ... +50 °C
Type of protection	IP 40 (when fitted)

Detection range (Square)

Detection zone standard		
Mounting height (A)	Sitting (S)	Walking (T)
2 m	9 m ² 3 m x 3 m	20 m ² 4,5 m x 4,5 m ± 0,5 m
2,5 m	16 m ² 4 m x 4 m	36 m ² 6 m x 6 m ± 0,5 m
3 m	20 m ² 4,5 m x 4,5 m	49 m ² 7 m x 7 m ± 1 m
3,5 m	–	64 m ² 8 m x 8 m ± 1 m

Detection zone reduced		
Mounting height (A)	Sitting (S)	Walking (T)
2 m	4 m ² 2 m x 2 m	4,4 m ² 2,1 m x 2,1 m ± 0,5 m
2,5 m	6,3 m ² 2,5 m x 2,5 m	9 m ² 3 m x 3 m ± 0,5 m
3 m	9 m ² 3 m x 3 m	14,4 m ² 3,8 m x 3,8 m ± 1 m
3,5 m	–	22,1 m ² 4,7 m x 4,7 m ± 1 m

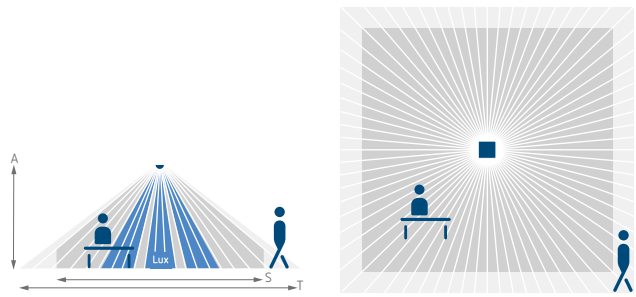

Accessories



theSenda B
↳ Art.No.: 9070985
Details page 359



theSenda P
↳ Art.No.: 9070910
Details page 359



theSenda S
↳ Art.No.: 9070911
Details page 359

Surface frame 75B WH
Details page 355

PlanoCover 76 BK
Details page 355

PlanoCover 76 SR
Details page 355

Scale drawings

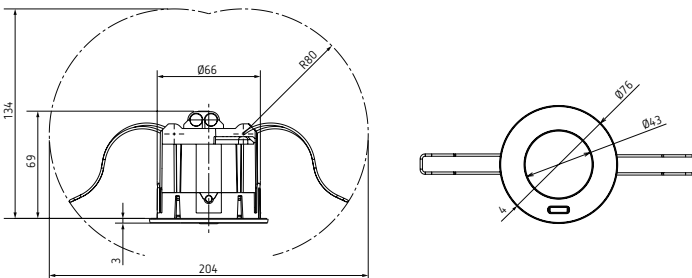

Presence and motion detectors/LED spotlights

Presence detectors KNX



Description

- KNX Passive infrared presence detector for ceiling mounting
- Round detection area 360°, up to Ø 24 m (452 m²)
- 2 channels light and 2 channels presence
- 2 channels light C1, C2 with 1 light measurement
- 2 presence channels can be parametrized individually
- Adaptable 1 channel light measurement
- Mixed light measurement suitable for LEDs, fluorescent lamps (FL/PL/ESL) and halogen/incandescent lamps
- Can be used as fully or semi-automatic, switchable
- Switch or constant light control mode with stand-by function
- Dimmable lighting in switch mode with stand-by function
- Brightness switching value or set point value can be set in lux using parameters, on the device itself or via remote control
- Teaching in of the brightness switching value or the set point value
- Room correction factor setting for brightness measurement calibration
- Light time delay can be set using parameters, on the device itself or via remote control
- Switch on delay and time delay for presence can be set
- Detection sensitivity can be set
- Reduced time delay in the event of a shorter stay in the room (short presence)
- Scenario functions
- Test mode for checking function and detection range
- Sensitivity adjustable
- Detection area can be limited using cover clip
- Manual override using telegram or remote control
- Parallel switching of several detectors in Master/Slave or Master/Master possible
- Ceiling installation in flush-mounted socket
- Ceiling installation also possible with surface-mounted frame
- User remote control and management-remote control (optional)

Product selection

Installation type	Colour	Type	Article number
Ceiling installation	White	theRonda P360 KNX UP WH	2089000

Technical data

	theRonda P360 KNX UP
Operating voltage KNX	Bus voltage, approx. 8 mA (9 mA LED on)
Installation height	2 – 15 m
Setting range brightness	10 – 3000 lx/measuring off
Light switch-off delay	30 s – 60 min
Stand-by dimming value	1 – 25 % of the lamp output
Stand-by time	30 s – 60 min/inactive/permanently on
Presence switch-off delay	10 s – 120 min
Presence switch-on delay	10 s – 30 min/inactive
Ambient temperature	– 15 °C ... +50 °C
Type of protection	IP 54 (when fitted)

Presence and motion detectors/LED spotlights

Presence detectors KNX

Detection range (Round)

Mounting height (A)	Sitting (S)	Walking diagonally (T)	Walking head on to
2 m	16 m ² 4,5 m	380 m ² 22 m	28 m ² 6 m
2,5 m	24 m ² 5,5 m	415 m ² 23 m	38 m ² 7 m
3 m	28 m ² 6 m	452 m ² 24 m	50 m ² 8 m
3,5 m	38 m ² 7 m	452 m ² 24 m	50 m ² 8 m
6 m	–	452 m ² 24 m	50 m ² 8 m
10 m	–	491 m ² 25 m	50 m ² 8 m

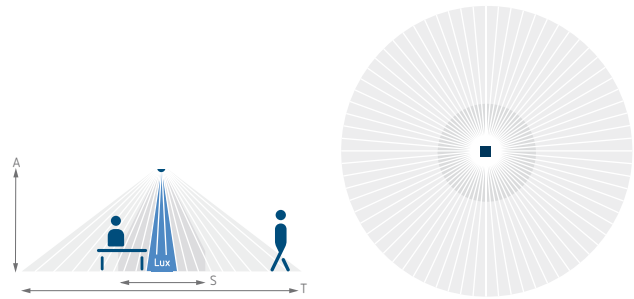

Accessories



Surface frame 110A WH

↳ Art.No.: 9070912
Details page 354



theSenda P

↳ Art.No.: 9070910
Details page 359



theSenda S

↳ Art.No.: 9070911
Details page 359

QuickSafe

Details page 355

theSenda B

Details page 359

Surface frame 110A GR

Details page 354

Ceiling installation box 68A

Details page 354

Masking clip

Details page 355

Cover 110 GR

Details page 355

Scale drawings

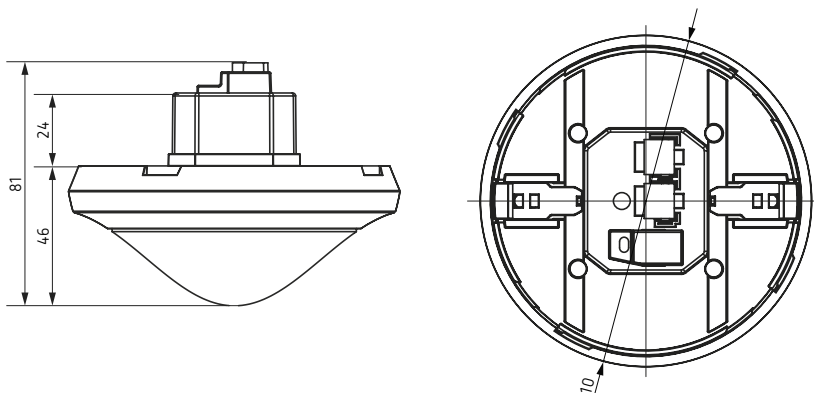

Presence and motion detectors/LED spotlights

Presence detectors KNX



Description

- KNX Passive infrared presence detector for ceiling installation
- Circular detection area 360°, up to Ø 9 m (64 m²)
- Automatic presence- and brightness-dependent control for lighting and HVAC
- Mixed light measurement suitable for fluorescent (FL/PL/ESL), halogen/ incandescent lamps and LEDs
- 2 light channels C1, C2
- Switching operation or constant light control with standby function (orientation light)
- Switching mode with dimmable lighting
- Choice of fully or semi-automatic
- Brightness switching value or set point value can be set in lux by using parameters, the object or via remote control
- Teach-in of the brightness switching value or the set point value
- Reduction of time delay when present briefly (short-term presence)
- Manual override by telegram or remote control
- 2 presence channels C4, C5, individually configurable
- Switch-on delay and time delay configurable
- Setting the room correction factor for brightness measurement comparison
- Adjustable sensitivity
- Test mode for checking function and detection area
- Scenes
- Parallel switching of multiple presence detectors (Master/Slave or Master/Master)
- User remote control «theSenda S» (option)
- Management remote control «theSenda B» (option)
- Installation remote control «theSenda P» (option)

Product selection

Installation type	Colour	Type	Article number
Ceiling installation	White	theRonda S360 KNX AP WH	2089550
	Grey	theRonda S360 KNX AP GR	2089551
	White	theRonda S360 KNX FLAT DE WH	2089560

Technical data

	theRonda S360 KNX AP	theRonda S360 KNX FLAT DE
Operating voltage KNX	Bus voltage, 9 mA	
Installation height	2–4 m	
Setting range brightness	approx. 30–3000 lx/measuring off	
Light switch-off delay	30 s–60 min	
Presence switch-off delay	10 s–120 min	
Presence switch-on delay	10 s–30 min/inactive	
Ambient temperature	–15 °C ... +50 °C	
Type of protection	IP 54 (when fitted)	

Detection range (Round)

Mounting height (A)	Sitting (S)	Walking (T)
2 m	5 m ² 2,5 m	38 m ² 7 m
2,5 m	7 m ² 3 m	38 m ² 7 m
3 m	13 m ² 4 m	50 m ² 8 m
3,5 m	-	50 m ² 8 m
4 m	-	64 m ² 9 m

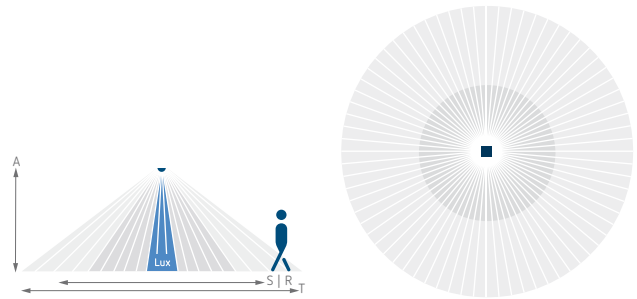

Accessories



theSenda B
↳ Art.No.: 9070985
Details page 359



theSenda P
↳ Art.No.: 9070910
Details page 359

theSenda S
Details page 359
Cover 85 FLAT GR
Details page 355

Scale drawings

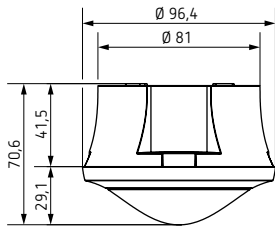

theRonda S360 KNX AP

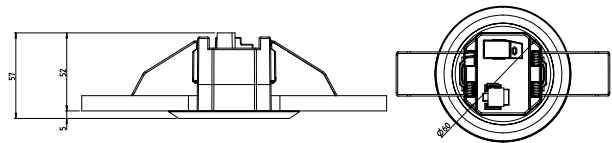
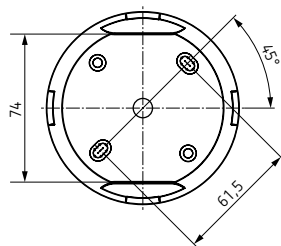

theRonda S360 KNX FLAT DE

Presence and motion detectors/LED spotlights

Presence detectors KNX

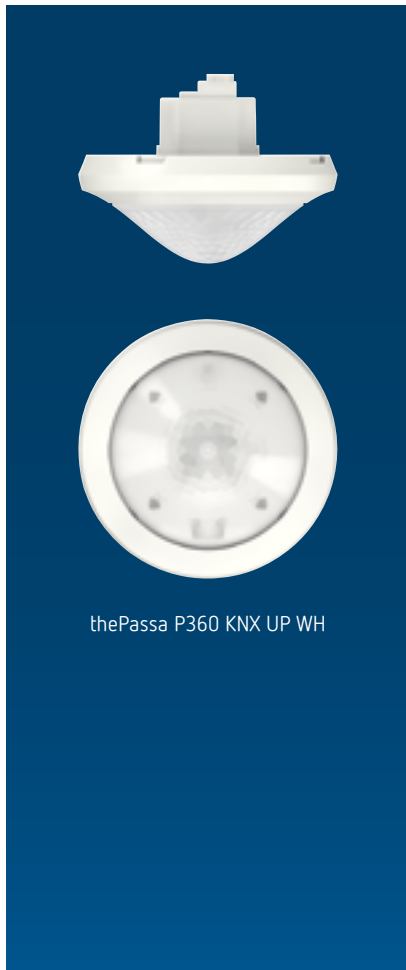

Description

- KNX Passive infrared presence detector for ceiling mounting
- Square detection area for corridors and storage areas
- Detection area with 2 individually connectable and disconnectable detection zones, each 15 x 5 m (total 30 x 5 m)
- 2 channel light and 2 channel presence
- 2 channel light C1, C2 with 2 light measurements
- 2 presence channels can be parametrized individually
- Adaptable 2 channel light measurement
- Function aura effect, switches on the lighting group when there is a person in its detection area and dims the adjacent lighting groups
- Function chaser light, recognises the direction of movement of the people in the room and „predictively“ switches on the adjacent lighting group
- Function walking direction recognition
- Mixed light measurement suitable for LEDs, fluorescent lamps (FL/PL/ESL) and halogen/incandescent lamps
- Can be used as fully or semi-automatic, switchable
- Switch or constant light control mode with stand-by function
- Dimmable lighting in switch mode with stand-by function
- Brightness switching value or set point value can be set in lux using parameters, on the device itself or via remote control
- Teaching in of the brightness switching value or the set point value
- Room correction factor setting for brightness measurement calibration
- Light time delay can be set using parameters, on the device itself or via remote control
- Switch on delay and time delay for presence can be set
- Detection sensitivity can be set
- Reduced time delay in the event of a shorter stay in the room (short presence)
- Scenario functions
- Test mode for checking function and detection range
- Sensitivity adjustable
- Detection area can be limited using cover clip
- Manual override using telegram or remote control
- Parallel switching of several detectors in Master/Slave or Master/Master possible
- Ceiling installation in flush-mounted socket
- Ceiling installation also possible with surface-mounted frame
- User remote control and management-remote control (optional)

Product selection

Installation type	Colour	Type	Article number
Ceiling installation	White	thePassa P360 KNX UP WH	2019300

Technical data

	thePassa P360 KNX UP WH
Operating voltage KNX	Bus voltage, ca. 9 mA
Installation height	2 – 15 m
Minimum height	> 1,7 m
Setting range brightness	10–3000 lx
Light switch-off delay	30 s–60 min
Presence switch-off delay	10 s–120 min
Switch-on delay presence	10 s–30 min / inactive
Ambient temperature	–15 °C ... +50 °C
Type of protection	IP 54 (when fitted)

Detection range (Rectangular)

Mounting height (A)	Head on to (r)	Diagonally (t)
2 m	56 m ² 16 m x 3,5 m	56 m ² 16 m x 3,5 m
2,5 m	72 m ² 18 m x 4 m	88 m ² 22 m x 4 m
3 m	90 m ² 20 m x 4,5 m	135 m ² 30 m x 4,5 m
3,5 m	100 m ² 20 m x 5 m	150 m ² 30 m x 5 m
4 m	100 m ² 20 m x 5 m	150 m ² 30 m x 5 m
4,5 m	100 m ² 20 m x 5 m	150 m ² 30 m x 5 m
5 m	100 m ² 20 m x 5 m	150 m ² 30 m x 5 m
5,5 m	100 m ² 20 m x 5 m	150 m ² 30 m x 5 m
6 m	100 m ² 20 m x 5 m	150 m ² 30 m x 5 m

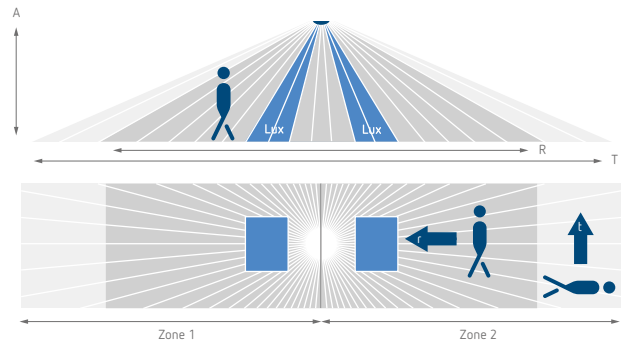

Accessories



Surface frame 110A WH

↳ Art.No.: 9070912

Details page 354



theSenda P

↳ Art.No.: 9070910

Details page 359



theSenda S

↳ Art.No.: 9070911

Details page 359

QuickSafe

Details page 355

theSenda B

Details page 359

Surface frame 110A GR

Details page 354

Ceiling installation box 68A

Details page 354

Masking clip

Details page 355

Cover 110 GR

Details page 355

Scale drawings

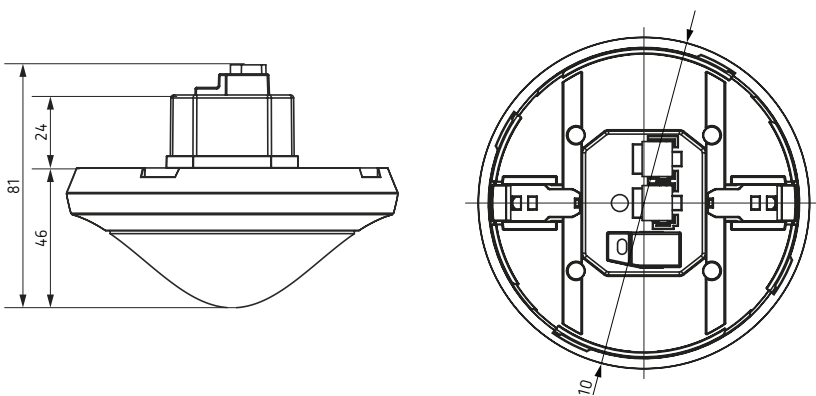

Presence and motion detectors/LED spotlights

Presence detectors KNX



Description

- Presence detector (PIR)
- Automatic control of lighting depending on presence and brightness
- Square detection area allows accurate and simple planning
- IP 54 for versatile use
- 2 channels light for controlling one or two lighting groups
- Mixed light measurement, suitable for fluorescent lamps (FL/PL/ESL), halogen/ incandescent lamps and LEDs
- Switching or constant light control with stand-by function
- Adjustable sensitivity
- Choice of fully or semi automatic operation: In „Semi-automatic“ mode the light must be switched on manually and switches off automatically
- Short presence; Reduced switch-off delay time in case of a short presence
- Self-learning time delay
- Channel presence with switch-off delay and switch-on delay time and send values
- Function „monitoring“ with reduced sensitivity only to detect walking persons
- Channel brightness (Lux)
- Set brightness level via bus object
- Scene functionality (8-bit scenes)
- Selected parameters can be configured remotely using the theSendä B remote control. Parameter settings are made via ETS
- Optional user remote control
- Ready for use by ex-factory set items
- Test operation to check detection area and installation
- Parallel switching of several presence detectors (master-slave or master-master) possible
- Ceiling mounting in flush-mounted box
- Possibility of surface mounting by using a surface frame

Product selection

Installation type	Colour	Type	Article number
Ceiling installation	Pure white (similar to RAL 9010)	PresenceLight 360B-KNX WH	2009000

Technical data

	PresenceLight 360B-KNX
Operating voltage KNX	Bus voltage, approx. 13 mA (17 mA LED on)
Installation height	2–3,5 m
Setting range brightness	approx. 5–2000 lx/measuring off
Light switch-off delay	30 s–60 min
Stand-by time	30 s–60 min, on, inactive
Presence switch-off delay	10 s–120 min
Presence switch-on delay	10 s–30 min/inactive
Ambient temperature	–10 °C ... +50 °C
Type of protection	IP 54

Detection range (Square)

Mounting height (A)	Walking (T)	Sitting (S)
2 m	20 m ² 4,5 m x 4,5 m ± 0,5 m	9 m ² 3 m x 3 m
2,5 m	36 m ² 6 m x 6 m ± 0,5 m	16 m ² 4 m x 4 m
3 m	49 m ² 7 m x 7 m ± 1 m	20 m ² 4,5 m x 4,5 m
3,5 m	64 m ² 8 m x 8 m ± 1 m	-

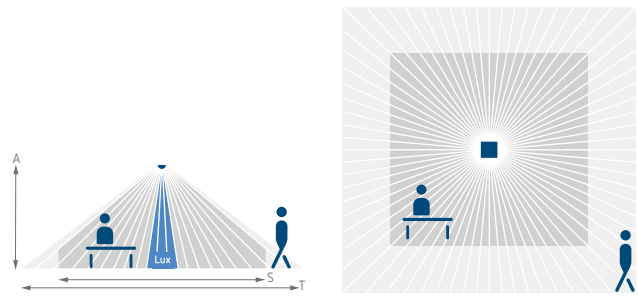

Accessories



Surface frame PresenceLight
↳ Art.No.: 9070513
Details page 354



theSenda B
↳ Art.No.: 9070985
Details page 359



QuickSafe
↳ Art.No.: 9070531
Details page 355



theSenda P
↳ Art.No.: 9070910
Details page 359



theSenda S
↳ Art.No.: 9070911
Details page 359

Cover frame PresenceLight 360 SR
Details page 354

Cover frame PresenceLight 360 BK
Details page 3554

Surface frame PresenceLight BK
Details page 354

Surface frame PresenceLight SR
Details page 354

Scale drawings

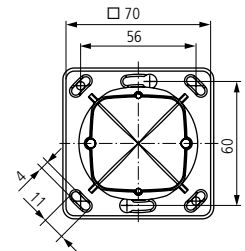
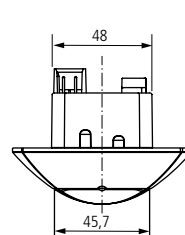
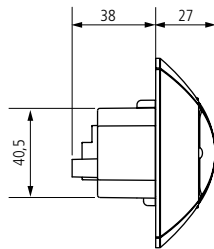
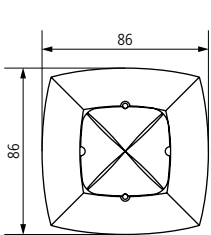

Presence and motion detectors/LED spotlights

Presence detectors KNX

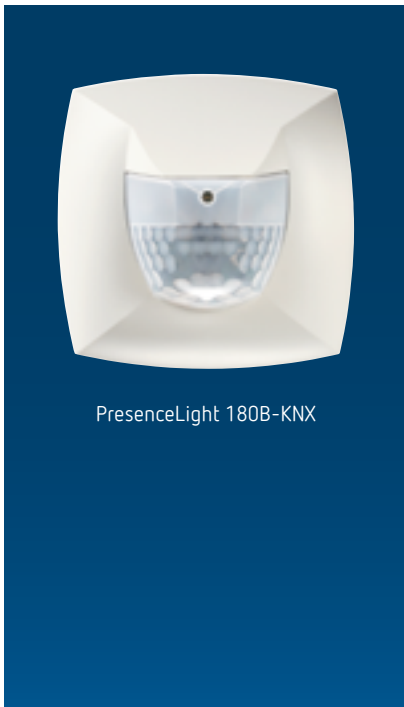

Description

- Presence detector (PIR)
- Automatic control of lighting depending on presence and brightness
- IP 54 for versatile use
- 2 channels light for controlling one or two lighting groups
- Mixed light measurement, suitable for fluorescent lamps (FL/PL/ESL), halogen/ incandescent lamps and LEDs
- Switching or constant light control with stand-by function
- Adjustable sensitivity
- Choice of fully or semi automatic operation: In „Semi-automatic“ mode the light must be switched on manually and switches off automatically
- Short presence; Reduced switch-off delay time in case of a short presence
- Channel presence with switch-off delay and switch-on delay time and send values
- Function „monitoring“ with reduced sensitivity only to detect walking persons
- Channel brightness (Lux)
- Set brightness level via bus object
- Scene functionality (8-bit scenes)
- Selected parameters can be configured remotely using the theSenda B remote control. Parameter settings are made via ETS
- Optional user remote control
- Ready for use by ex-factory set items
- Test operation to check detection area and installation
- Parallel switching of several presence detectors (master-slave or master-master) possible
- Wall mounting in flush-mounted box
- Possibility of surface mounting by using a surface frame

Product selection

Installation type	Colour	Type	Article number
Wall installation	Pure white (similar to RAL 9010)	PresenceLight 180B-KNX WH	2009050

Technical data

	PresenceLight 180B-KNX
Operating voltage KNX	Bus voltage, approx. 13 mA (17 mA LED on)
Installation height	1,7–2,2 m
Setting range brightness	approx. 5–2000 lx/measuring off
Light switch-off delay	30 s–60 min
Stand-by dimming value	5–10 %
Stand-by time	30 s–60 min/on/inactive
Presence switch-off delay	10 s–120 min
Presence switch-on delay	10 s–30 min/inactive
Ambient temperature	–10 °C ... +50 °C
Type of protection	IP 54

Detection range (Semicircular)

Mounting height (A)	Walking (T)	Sitting (S)
2,2 m	100 m ² 8 m	25 m ² 7 m x 3,5 m

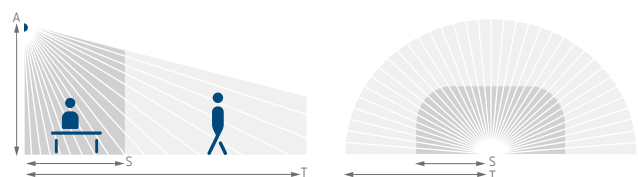

Accessories



Surface frame PresenceLight
↳ Art.No.: 9070513
Details page 354



theSenda B
↳ Art.No.: 9070985
Details page 359



QuickSafe
↳ Art.No.: 9070531
Details page 355



theSenda P
↳ Art.No.: 9070910
Details page 359



theSenda S
↳ Art.No.: 9070911
Details page 359

Cover frame PresenceLight 180 SR
Details page 354

Cover frame PresenceLight 180 BK
Details page 354

Surface frame PresenceLight BK
Details page 354

Surface frame PresenceLight SR
Details page 354



Scale drawings

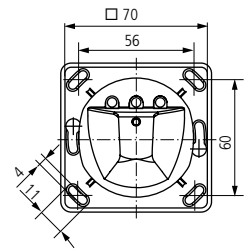
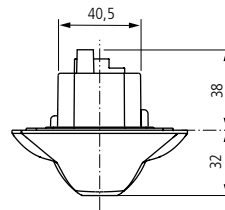
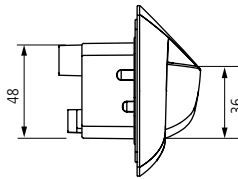
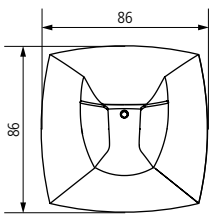

Presence and motion detectors/LED spotlights

Motion detectors



Description

- Passive infra-red motion detector for ceiling installation
- Circular detection area 360°, up to Ø 8 m (50 m²)
- Automatic motion and brightness-dependent control for lighting
- Mixed light measurement suitable for fluorescent lamps (FL/PL/ESL), halogen/ incandescent lamps and LEDs
- Channel A light: relay, 230 V
- Operation as fully automatic device
- Brightness switching value configurable, teach-in function
- Pulse function for staircase light time switch
- Time delay configurable
- Extension of detection area via Master/ Slave switching
- Test mode for checking function and detection area
- Diameter of ceiling cutout 34–36 mm
- Ready for immediate use due to factory presetting

Product selection

Installation type	Channel	Operating voltage	Colour	Type	Article number
Ceiling installation	Light	110–240 V AC	White	thePiccola S360-100 DE WH	1060200

Technical data

thePiccola S360-100 DE WH			
Operating voltage	110–240 V AC	Fluorescent lamp load (conventional) parallel-corrected	1300 VA, 140 µF
Frequency	50–60 Hz	Fluorescent lamp load (conventional) series-corrected	2000 VA
Installation height	2–6 m	Fluorescent lamp load (electronic ballast)	1200 W
Power consumption	0,4 W	LED lamp < 2 W (typ.)	55 W
Setting range brightness	5–1000 lx	LED lamp > 2 W (typ.)	600 W
Light switch-off delay	30 s–30 min	Ambient temperature	–20 °C ... +50 °C
Incandescent/halogen lamp load	2000 W	Type of protection	IP 55 (Sensor), IP 20 (power module) (when mounted)
Fluorescent lamp load (conventional) not corrected	2000 VA		

Detection range (Round)

Mounting height (A)	Head on to (r)	Diagonally (t)
2,5 m	3 m ² 2 m	50 m ² 8 m

Detection range according to sensNORM IEC 63180 see datasheet

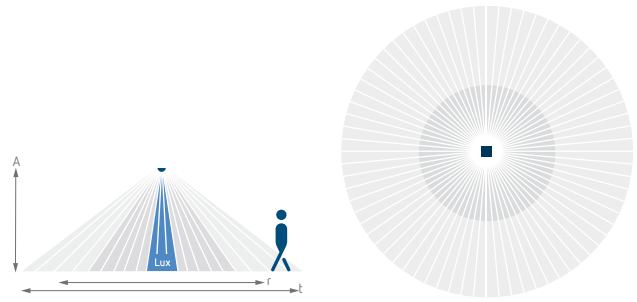

Scale drawings

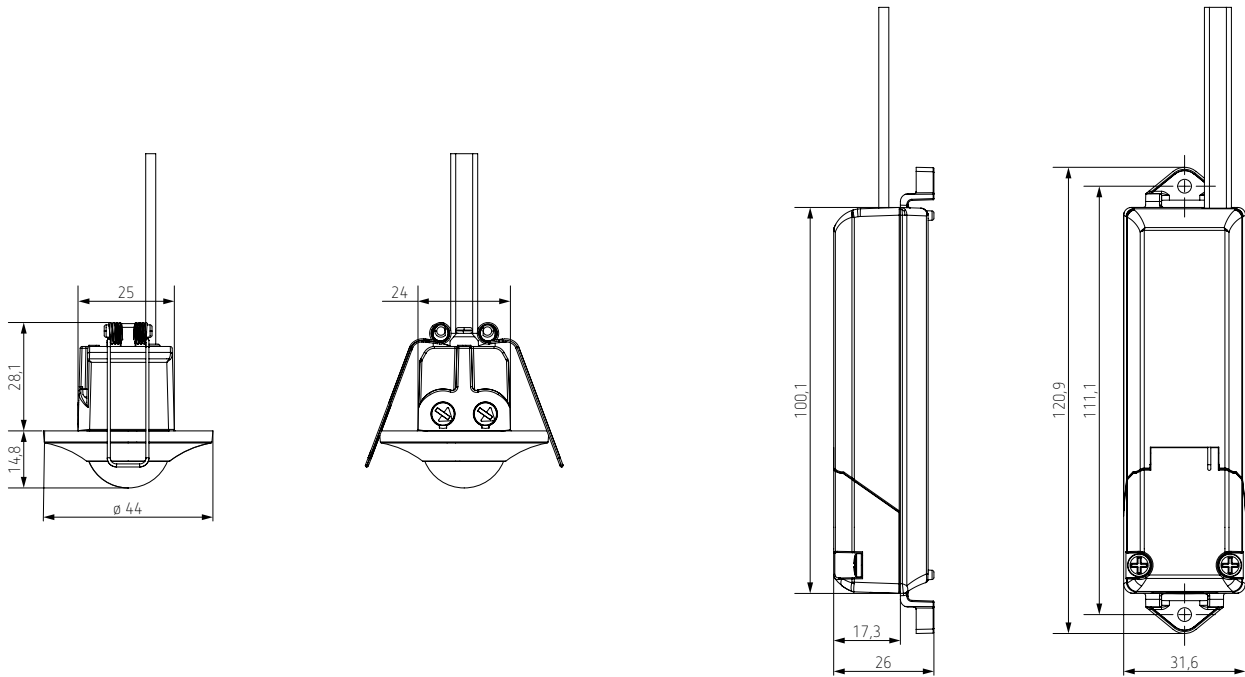

Connection diagrams

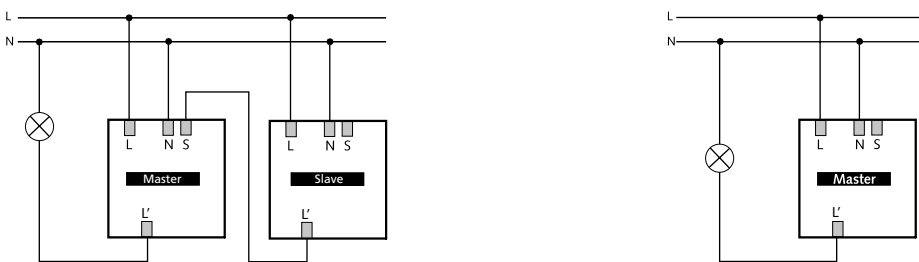

Presence and motion detectors

Motion detectors



Description

- Passive infrared motion detector for ceiling installation
- Circular detection area 360°, up to Ø 9 m (64 m²)
- Mixed light measurement suitable for fluorescent lamps (FL/PL/ESL), halogen/incandescent lamps and LEDs
- Channel A light: relay, 230 V
- Operation as fully automatic device
- Configurable brightness switching value, teach-in function
- Pulse function for staircase light timer switch
- Configurable time delay
- Configurable detection sensitivity
- Test mode for checking function and detection area
- Ready for immediate use due to factory presetting (brightness switching value 300 lux, time delay 10 minutes)
- One of these optional remote controls is required to change the values and settings:
 - theSenda B app remote control
 - theSenda P service remote control
 - Optional user remote control: theSenda S

theMova S360-100 FLAT DE

- Automatic motion and brightness-dependent control for lighting

theMova S360-101 FLAT DE

- Automatic motion and brightness-dependent control for lighting and HVAC
- Channel H, presence: relay, floating, e.g. for HVAC control
- Configurable switch-on delay and time delay

Product selection

Type	Channel	Operating voltage	Colour	Type	Article number
Motion detector	Light	230 V AC	White	theMova S360-100 FLAT DE WH	1030540
	Light Presence	230 V AC	White	theMova S360-101 FLAT DE WH	1030545

Technical data

	theMova S360-100 FLAT DE WH	theMova S360-101 FLAT DE WH
Operating voltage	230 V AC	
Frequency	50 Hz	
Power consumption	0.5 W	
Installation height	2–4 m	
Minimum height	> 1.7 m	
Brightness setting range	30–3000 lx, on	
Lighting time delay	Pulse (0.5 s), 10 s–60 min	
Incandescent/halogen lamp load	2300 W	
Compact/fluorescent lamp load	1150 VA (cos ϕ = 0.5)	
Inrush current	Max. 400 A/200 μ s	
LED lamp < 2 W (typ.)	25 W	
LED lamp > 2 W (typ.)	250 W	
Presence switching capacity	–	50 W/50 VA, max. 2 A
Presence switch-on delay	–	0 s–10 min
Presence time delay	–	10 s–120 min
Ambient temperature	–15 °C to +50 °C	
Protection rating	IP 54 (installed)	

Detection area (circular)

Installation height (A)	Head on to (R)	Transverse (T)
2 m	5 m ² 2.5 m	38 m ² 7 m
2.5 m	7 m ² 3 m	38 m ² 7 m
3 m	13 m ² 4 m	50 m ² 8 m
3.5 m	13 m ² 4 m	50 m ² 8 m
4 m	13 m ² 4 m	64 m ² 9 m

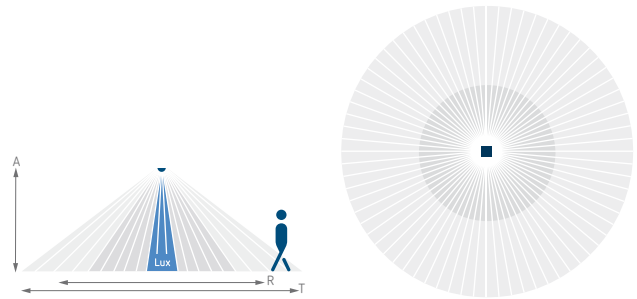

Accessories



theSenda B
↳ Art.No.: 9070985
Details page 359



theSenda P
↳ Art.No.: 9070910
Details page 359

theSenda S
Details page 359
Cover 85 FLAT GR
Details page 355



Scale drawings

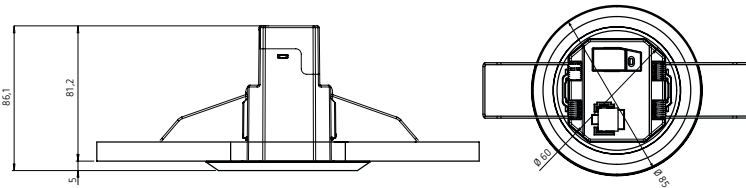

Connection example

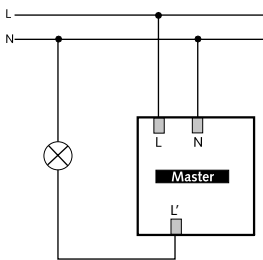

theMova S360-100

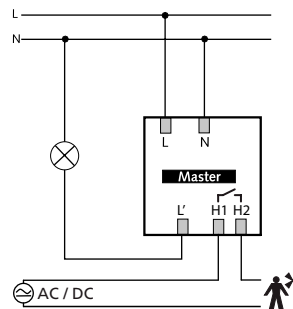

theMova S360-101

Presence and motion detectors/LED spotlights

Motion detectors



Description

- Passive infra-red motion detector for ceiling installation
 - Circular detection area 360°, up to Ø 9 m (64 m²)
 - Mixed light measurement suitable for fluorescent lamps (FL/PL/ESL), halogen/ incandescent lamps and LEDs
 - Channel A light: relay, 230 V
 - Operation as fully automatic device
 - Brightness switching value configurable, teach-in function
 - Pulse function for staircase light time switch
 - Detection sensitivity configurable
 - Test mode for checking function and detection area
 - Ready for immediate use due to factory presetting (Brightness switching value 300 lux, Time delay 10 min)
- One of these optional remote controls is required for changing the values and attitudes:
 - Management remote control theSenda B
 - Installation remote control theSenda P
 - Optional user remote control:
 - theSenda S
- theMova S360-100 DE**
- 1 channel light
 - Automatic motion and brightness-dependent control for lighting
- theMova S360-101 DE**
- 1 channel light and 1 channel presence
 - Automatic motion and brightness-dependent control for lighting and HVAC
 - Channel H, presence: relay, floating e.g. for HVAC control
 - Time delay configurable

Product selection

Installation type	Channel	Operating voltage	Colour	Type	Article number
Ceiling installation	Light	230 V AC	White	theMova S360-100 DE WH	1030560
	Light Presence	230 V AC	White	theMova S360-101 DE WH	1030565

Technical data

	theMova S360-100 DE	theMova S360-101 DE
Operating voltage	230 V AC	
Frequency	50 Hz	
Recommended installation height	2–3,5 m	
Power consumption	0,5 W	
Setting range brightness	30–3000 lx	
Light switch-off delay	10 s–60 min	
Type of contact light	Relay 230 V/10 A µ-contact	
Incandescent/halogen lamp load	2300 W	
Compact and fluorescent lamps	1150 VA (cos φ = 0,5)	
Inrush current	max. 400 A/200 µs	
LED lamp < 2 W (typ.)	25 W	
LED lamp > 2 W (typ.)	250 W	
Switching capacity presence	–	50 W/50 VA
Ambient temperature	–15 °C ... +50 °C	
Type of protection	IP 40 (when fitted)	

Detection range (Round)

Mounting height (A)	Head on to (r)	Diagonally (t)
2 m	5 m ² 2,5 m	38 m ² 7 m
2,5 m	7 m ² 3 m	38 m ² 7 m
3 m	13 m ² 4 m	50 m ² 8 m
3,5 m	13 m ² 4 m	50 m ² 8 m
4 m	13 m ² 4 m	64 m ² 9 m

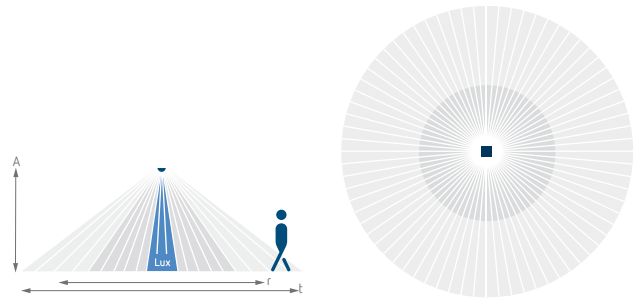

Accessories



theSenda B
↳ Art.No.: 9070985
Details page 359



theSenda P
↳ Art.No.: 9070910
Details page 359

theSenda S
Details page 359
Cover 85 GR
Details page 355

Scale drawings

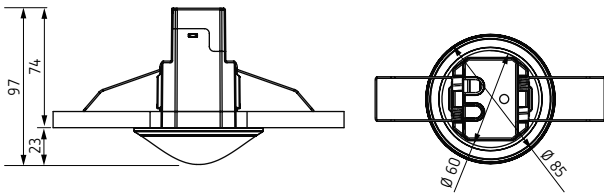

Connection diagrams

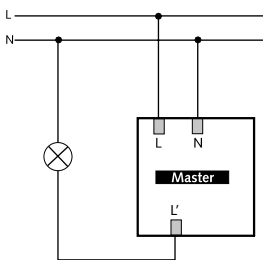

theMova S360-100 DE

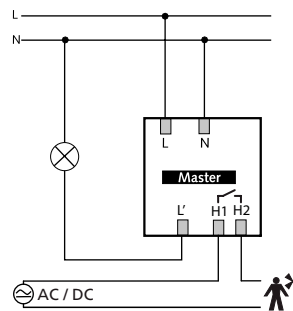

theMova S360-101 DE

Presence and motion detectors/LED spotlights

Motion detectors



Description

- Passive infra-red motion detector for ceiling installation
 - Circular detection area 360°, up to Ø 9 m (64 m²)
 - Mixed light measurement suitable for fluorescent lamps (FL/PL/ESL), halogen/ incandescent lamps and LEDs
 - Channel A light: relay, 230 V
 - Operation as fully automatic device
 - Brightness switching value configurable, teach-in function
 - Pulse function for staircase light time switch
 - Detection sensitivity configurable
 - Test mode for checking function and detection area
 - Ready for immediate use due to factory presetting (Brightness switching value 300 lux, Time delay 10 min)
- One of these optional remote controls is required for changing the values and attitudes:
 - Management remote control theSenda B
 - Installation remote control theSenda P
 - Optional user remote control:
 - theSenda S
- theMova S360-100 AP**
- 1 channel light
 - Automatic motion and brightness-dependent control for lighting
- theMova S360-101 AP**
- 1 channel light and 1 channel presence
 - Automatic motion and brightness-dependent control for lighting and HVAC
 - Channel H, presence: relay, floating e.g. for HVAC control
 - Time delay configurable

Product selection

Installation type	Channel	Operating voltage	Colour	Type	Article number
Ceiling installation	Light	230 V AC	White	theMova S360-100 AP WH	1030550
			Grey	theMova S360-100 AP GR	1030551
	Light Presence	230 V AC	White	theMova S360-101 AP WH	1030555
			Grey	theMova S360-101 AP GR	1030556

Technical data

	theMova S360-100 AP	theMova S360-101 AP
Operating voltage	230 V AC	
Frequency	50 Hz	
Recommended installation height	2–3,5 m	
Power consumption	0,5 W	
Setting range brightness	30–3000 lx	
Light switch-off delay	10 s–60 min	
Type of contact light	Relay 230 V/10 A µ-contact	
Incandescent/halogen lamp load	2300 W	
Compact and fluorescent lamps	1150 VA (cos φ = 0,5)	
Inrush current	max. 400 A/200 µs	
LED lamp < 2 W (typ.)	25 W	
LED lamp > 2 W (typ.)	250 W	
Switching capacity presence	–	50 W/50 VA
Ambient temperature	– 15 °C ... +50 °C	
Type of protection	IP 54	

Detection range (Round)

Mounting height (A)	Head on to (r)	Diagonally (t)
2 m	5 m ² 2,5 m	38 m ² 7 m
2,5 m	7 m ² 3 m	38 m ² 7 m
3 m	13 m ² 4 m	50 m ² 8 m
3,5 m	13 m ² 4 m	50 m ² 8 m
4 m	13 m ² 4 m	64 m ² 9 m

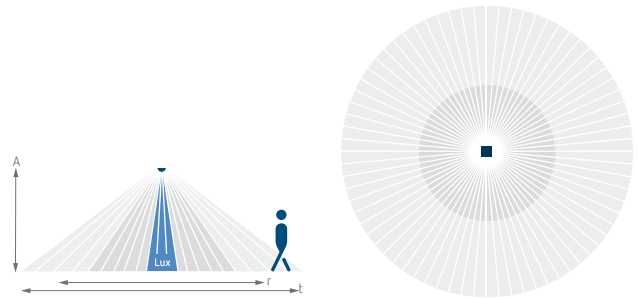

Accessories



theSenda B
↳ Art.No.: 9070985
Details page 359



theSenda P
↳ Art.No.: 9070910
Details page 359



theSenda S
↳ Art.No.: 9070911
Details page 359

Scale drawings

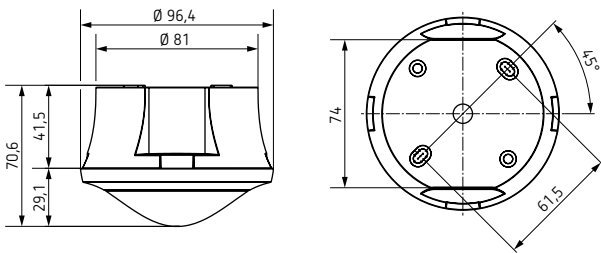

Connection diagrams

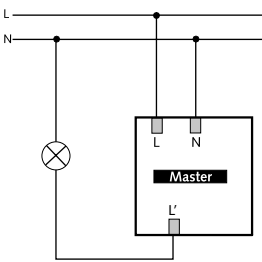

theMova S360-100 AP

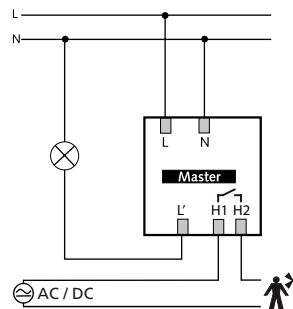

theMova S360-101 AP

Presence and motion detectors/LED spotlights

Motion detectors



Description

- Motion detector (PIR), with pre-configured cable and Wieland GSTi18 connector, cable length 1,50 meter
- Circular detection area 360°, up to Ø 9 m (64 m²)
- Automatic motion and brightness-dependent control for lighting
- Mixed light measurement
- Channel A light: relay, 230 V
- Operation as fully automatic device
- Brightness switching value configurable, teach-in function
- Pulse function for staircase light time switch
- Time delay configurable
- Detection sensitivity configurable
- Test mode for checking function and detection area
- Ready for immediate use due to factory presetting (Brightness switching value 300 lux, Time delay 10 min)
- One of these optional remote controls is required for changing the values and attitudes:
 - Management remote control theSenda B
 - Installation remote control theSenda P
- **Optional user remote control:**
 - theSenda S

Product selection

Installation type	Channel	Operating voltage	Colour	Type	Article number
Ceiling installation	Light	230 V AC	White	theMova S360-100 WH GST	1030570

Technical data

	theMova S360-100 WH
Operating voltage	230 V AC
Frequency	50 Hz
Installation height	2–4 m
Power consumption	0,5 W
Setting range brightness	30–3000 lx
Light switch-off delay	10 s–60 min
Type of contact light	Relay 230 V / 10 A µ-contact
Incandescent/halogen lamp load	2300 W
Compact and fluorescent lamps	1150 VA (cos φ = 0,5)
Inrush current	max. 400 A / 200 µs
LED lamp < 2 W (typ.)	25 W
LED lamp 2–8 W (typ.)	70 W
LED lamp > 8 W (typ.)	250 W
Ambient temperature	–15 °C ... +50 °C
Type of protection	IP 54 (when fitted)

Detection range (Round)

Mounting height (A)	Head on to (r)	Diagonally (t)
2 m	5 m ² 2,5 m	38 m ² 7 m
2,5 m	7 m ² 3 m	38 m ² 7 m
3 m	13 m ² 4 m	50 m ² 8 m
3,5 m	13 m ² 4 m	50 m ² 8 m
4 m	13 m ² 4 m	64 m ² 9 m

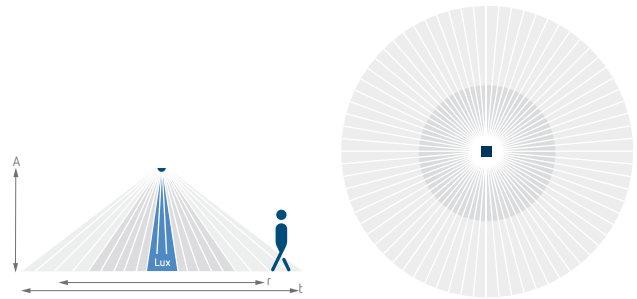

Accessories



theSenda B
↳ Art.No.: 9070985
Details page 359



theSenda P
↳ Art.No.: 9070910
Details page 359

theSenda S
Details page 359

Cover 85 GR
Details page 355

Scale drawings

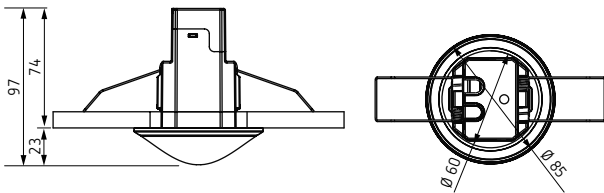

Connection diagrams

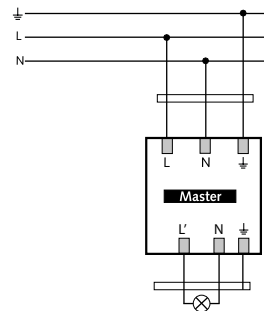

Presence and motion detectors/LED spotlights

Motion detectors



Description

- Passive infra-red motion detector for ceiling installation
- Circular detection area 360°, up to Ø 24 m (452 m²)
- Restriction of detection area with cover clips
- Automatic motion and brightness-dependent control for lighting
- Mixed light measurement suitable for fluorescent lamps (FL/PL/ESL), halogen/ incandescent lamps and LEDs
- Channel A light: relay, 230 V
- Operation as fully automatic device
- Brightness switching value configurable, teach-in function
- Pulse function for staircase light time switch
- Time delay configurable
- Detection sensitivity configurable
- Ready for immediate use due to factory presetting
- Test mode for checking function and detection area
- Ceiling installation in flush-mounted socket
- Ceiling installation possible with back box, IP44 (option)
- User remote control theSenda S (option)
- Management remote control theSenda B (option)
- Installation remote control theSenda P (option)

Product selection

Installation type	Channel	Operating voltage	Colour	Type	Article number
Ceiling installation	Light	110–230 V AC	White	theMova P360-100 UP WH	1030600

Technical data

	theMova P360-100 UP
Operating voltage	110–230 V AC
Frequency	50–60 Hz
Recommended installation height	2–10 m
Power consumption	0,15 W
Setting range brightness	30–3000 lx
Light switch-off delay	10 s–60 min
Type of contact light	Relay 230 V/10 A µ-contact
Incandescent/halogen lamp load	2300 W
Compact and fluorescent lamps	1150 VA (cos φ = 0,5)
Inrush current	max. 800 A/200 µs
LED lamp < 2 W (typ.)	60 W
LED lamp > 2 W (typ.)	600 W
Ambient temperature	–15 °C ... +50 °C
Type of protection	IP 54 (when fitted)

Detection range (Round)

Mounting height (A)	Head on to (r)	Diagonally (t)
2 m	28 m ² 6 m	380 m ² 22 m
2,5 m	38 m ² 7 m	415 m ² 23 m
3 m	50 m ² 8 m	452 m ² 24 m
3,5 m	50 m ² 8 m	452 m ² 24 m
6 m	50 m ² 8 m	452 m ² 24 m
10 m	50 m ² 8 m	452 m ² 24 m

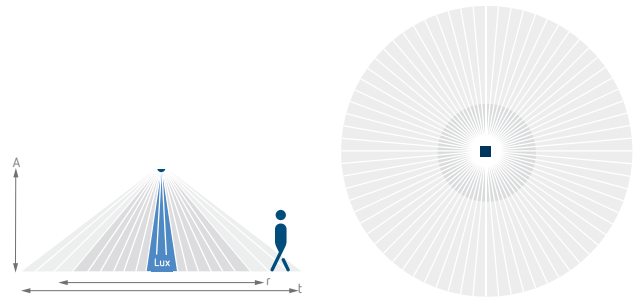

Accessories



Surface frame 110A WH
↳ Art.No.: 9070912
Details page 354



theSenda P
↳ Art.No.: 9070910
Details page 359



theSenda S
↳ Art.No.: 9070911
Details page 359

QuickSafe
Details page 355

theSenda B
Details page 359

Surface frame 110A GR
Details page 354

Ceiling installation box 68A
Details page 354

Masking clip
Details page 355

Cover 110 GR
Details page 354

Scale drawings

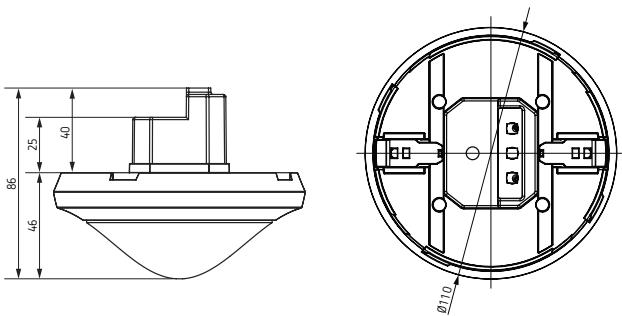

Connection diagrams

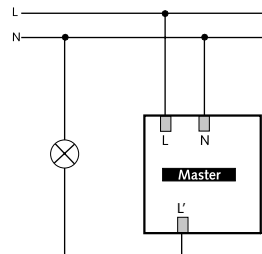

Presence and motion detectors/LED spotlights

Motion detectors



LUXA 103 DE

LUXA 103 AP

Description

Common functions

- Motion detector (PIR)
- Automatic lighting control based on presence and brightness
- Mixed light measurement suitable for the control of fluorescent, incandescent, halogen lamps and LED
- Zero-cross switching for relay-saving switching and high lamp loads
- Easy installation via two clamping brackets
- Large clamping area for quick installation
- Single-handed plug-in installation with captive screws
- Instant start-up possible via factory preset

- No unintentional adjustment due to covered up controls
- Adjustable brightness switching value and switch-off delay

LUXA 103-100 DE

- 1 channel
- System consists of power box and sensor with plugged connection cable

LUXA 103-101 DE

- 2 channels
- 2. Relay for HVAC control with adjustable switch-off delay, presence-dependent, potential-free

- HVAC control with programmable switch-off delay

- System consists of power box and sensor with plugged connection cable

LUXA 103-100 AP

- 1 channel

LUXA 103-101 AP

- 2 channels
- 2. Relay for HVAC control with adjustable switch-off delay, presence-dependent, potential-free
- HVAC control with programmable switch-off delay

Product selection

Installation type	Channel	Operating voltage	Colour	Type	Article number
False ceilings	Light	230 V AC	White	LUXA 103-100 DE WH	1030012
	Light Presence	230 V AC	White	LUXA 103-101 DE WH	1030013
Ceiling	Light	230 V AC	White	LUXA 103-100 AP WH	1030022
	Light Presence	230 V AC	White	LUXA 103-101 AP WH	1030023

Technical data

	LUXA 103-100 DE	LUXA 103-101 DE	LUXA 103-100 AP	LUXA 103-101 AP
Operating voltage	230 V AC			
Frequency	50–60 Hz			
Installation height	2–3 m			
Stand-by consumption	0,5 W			
Setting range brightness	10–2000 lx			
Light switch-off delay	5 s–30 min			
Switching capacity light	10 A (230 V AC, cos φ = 1)			
Incandescent lamp load	2000 W			
LED lamp < 2 W (typ.)	35 W			
LED lamp > 2 W (typ.)	400 W			
Switching capacity presence	–	5 A (250 V AC, cos φ = 1)	–	5 A (250 V AC, cos φ = 1)
Presence switch-off delay	–	10 s–60 min	–	10 s–60 min
Ambient temperature	0 °C ... +45 °C			
Type of protection	IP 44 (Sensor), IP 20 (power module)		IP 40	

Detection range (Round)

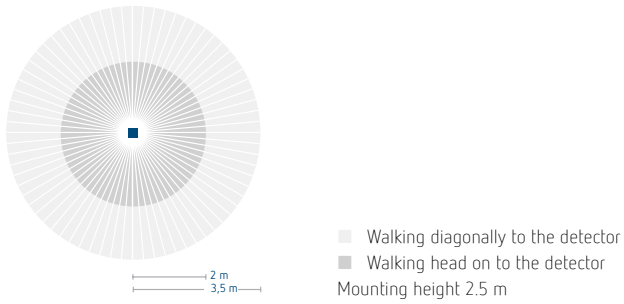

Dimensions

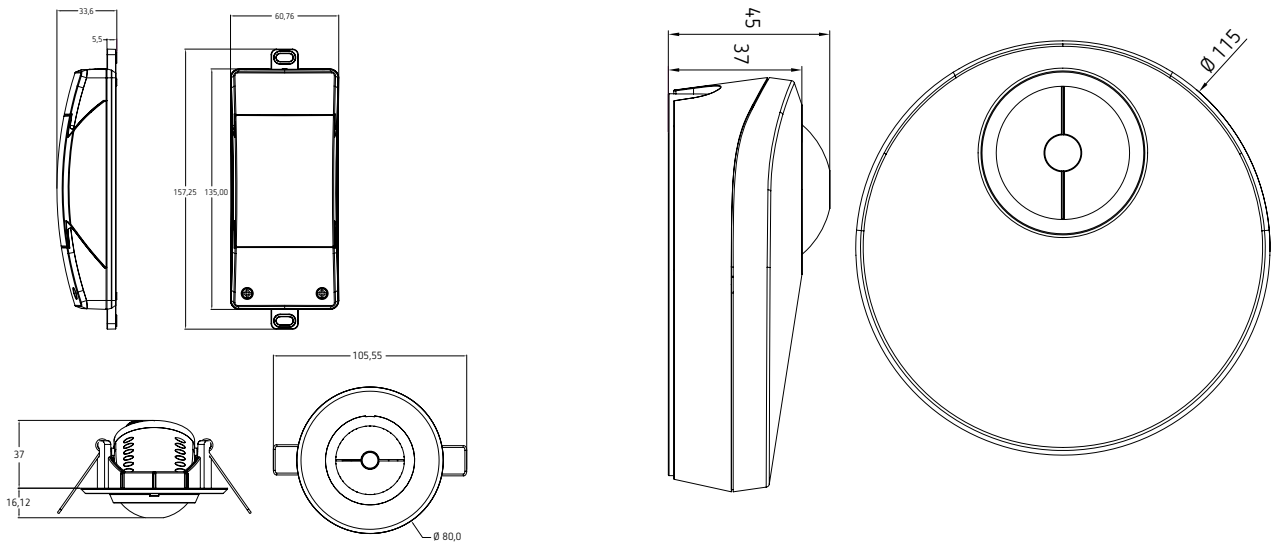

LUXA 103 DE

LUXA 103 AP

Connection diagrams

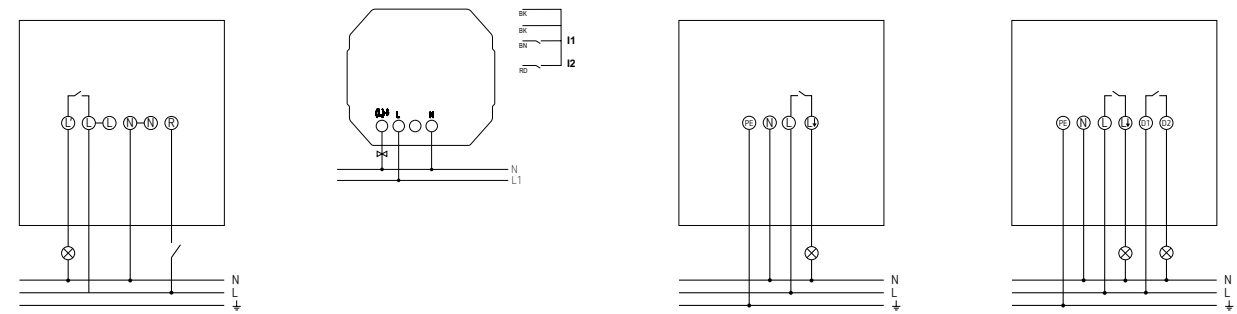

LUXA 103-100 DE

LUXA 103-101 DE

LUXA 103-100 AP

LUXA 103-101 AP

Presence and motion detectors/LED spotlights

Motion detectors



Description

- Motion detector (PIR)
- 1 channel
- Automatic lighting control based on presence and brightness
- Mixed light measurement suitable for the control of fluorescent, incandescent, halogen lamps and LED
- Zero-cross switching for relay-saving switching and high lamp loads
- Large clamping area for quick installation
- Single-handed plug-in installation with captive screws
- Instant start-up possible via factory preset
- No unintentional adjustment due to covered up controls
- Adjustable brightness switching value and switch-off delay

Product selection

Installation type	Channel	Colour	Type	Article number
Ceiling installation	Light	White	LUXA 103-100 C DE WH	1030016

Technical data

	LUXA 103-100 C DE
Operating voltage	230 V AC
Frequency	50–60 Hz
Installation height	2–3 m
Stand-by consumption	0,5 W
Setting range brightness	10–2000 lx
Light switch-off delay	5 s–30 min
Switching capacity light	10 A (230 V AC, $\cos \varphi = 1$)
Incandescent lamp load	2000 W
LED lamp < 2 W (typ.)	35 W
LED lamp > 2 W (typ.)	400 W
Ambient temperature	0 °C ... +45 °C
Type of protection	IP 44

Detection range (Round)

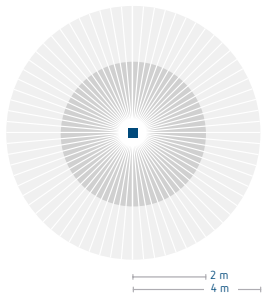

- Walking diagonally to the detector
 - Walking head on to the detector
- Mounting height 2.5 m



Dimensions

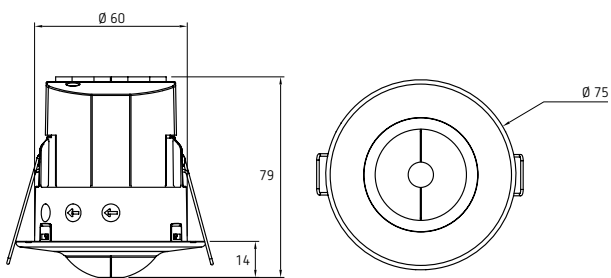

Connection diagrams

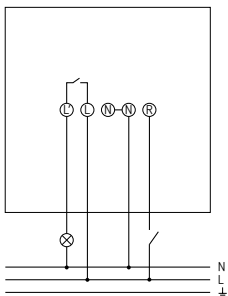

LUXA 103-100 C DE

Presence and motion detectors/LED spotlights

Motion detectors



Description

- Motion detector (PIR)
- Automatic lighting control based on presence and brightness
- 1 channel
- With acoustic function
- Activation by the PIR sensor and deactivation by the microphone (microphone can also be deactivated)
- Flexible installation options, ceiling installation using clamping brackets as well as flush-mounted or surface mounting using the optional surface frame
- Mixed light measurement suitable for the control of fluorescent, incandescent, halogen lamps and LED
- Zero-cross switching
- Detection area can be limited using three enclosed segments
- Instant start-up possible via factory preset
- No unintentional adjustment due to covered up controls
- Adjustable brightness switching value and switch-off delay
- Sensitivity can be reduced to limit detection area
- Pulse function
- Test function

Product selection

Installation type	Channel	With acoustic function	Colour	Type	Article number
Ceiling installation	Light	✓	White	LUXA 103-100 UA WH	1030045

Technical data

	LUXA 103-100 UA WH
Operating voltage	230 V AC
Frequency	50–60 Hz
Stand-by consumption	0,5 W
Installation height	2–4 m
Detection angle	360°
Setting range brightness	10–2000 lx
Light switch-off delay	5 s–30 min
Incandescent lamp load	2000 W
LED lamp < 2 W (typ.)	35 W
LED lamp > 2 W (typ.)	400 W
Ambient temperature	–20 °C ... +45 °C
Protection class	II
Type of protection	IP 40 (when fitted)

Detection range (Round)

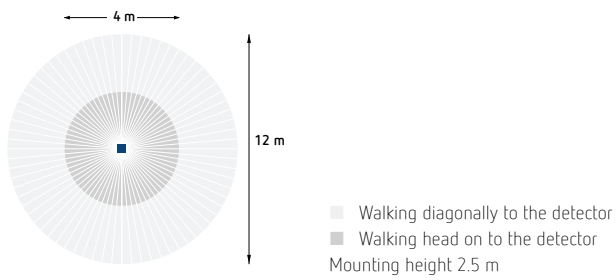

LUXA 103-100 UA WH



Dimensions

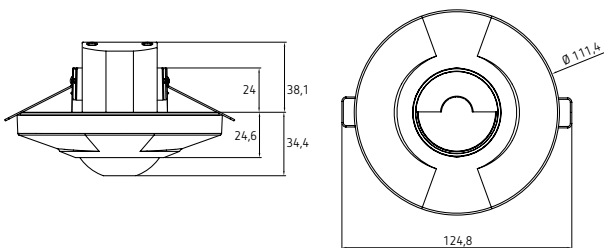

Connection diagrams

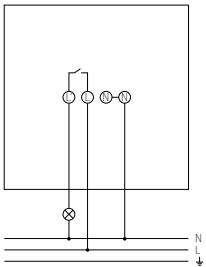

Accessories



Surface frame LUXA 103-100 U

↳ Art.No.: 9070986

Details page 357

Presence and motion detectors/LED spotlights

Motion detectors

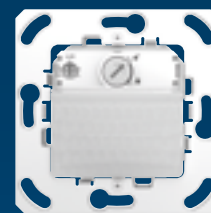

theMura S180-100 UP WH
theMura S180-101 UP WH
theMura S180 Slave UP WH
theMura S180-100 2W UP WH

theMura S180-101 B UP
theMura S180-100 B UP

theMura S180 Slave B UP

theMura S180-100 2W B UP



Description

Common functions

- Passive infrared motion/presence detector for flush-mounted wall mounting
- Semicircular detection area 170°, up to 14x17 m
- Mixed light measurement suitable for the control of fluorescent, incandescent, halogen lamps and LEDs
- Integrated button (can be blocked)
- Available with Theben frame or without frame
- Adapter frames for common switch ranges available as accessory, see www.theben.de/theMura

theMura S180-100 UP WH (with Theben frame) theMura S180-100 B UP (without frame)

- Motion detector,
- 1 channel light
- Fully or semi-automatic operation
- Adjustable brightness switching value, teach-in function
- Staircase light function
- Switch-on delay configurable
- Extension of detection area via master/slave switching
- Ready for immediate use due to factory presetting

theMura S180-101 UP WH (with Theben frame)

theMura S180-101 B UP (without frame)

- Presence detector
- 1 channel light
- 1 channel presence
- Fully or semi-automatic operation
- External button can be connected
- Adjustable brightness switching value, teach-in function
- Automatic calibration of brightness measurement
- Switch-on delay configurable
- Short-term presence
- Acoustic function
- Orientation light
- Configurable sensitivity
- External button can be connected
- Staircase light function
- Extension of detection area via master/slave switching
- Ready for immediate use due to factory presetting
- Remote operation with theSenda S, theSenda P, theSenda B

theMura S180 Slave UP WH

(with Theben frame)

theMura S180 Slave B UP (without frame)

- Slave version for:
 - theMura S180-100 UP WH
 - theMura S180-100 B UP
 - theMura S180-101 UP WH
 - theMura S180-101 B UP

theMura S180-100 2W UP WH

(with Theben frame)

theMura S180-100 2W B UP (without frame)

- Motion detector
- 1 channel light
- 2-wire version in combination with an ELPA staircase time switch for switching the lamp loads
- Adjustable brightness switching value, teach-in function
- Ideal for replacing existing buttons
- Switch-on delay configurable on the staircase time switch
- Parallel connection possible (up to 12 detectors towards an ELPA)

Product selection

With Theben frame	Channel	Product type	Type	Article number
✓	Light	Motion detector	theMura S180-100 UP WH	2060650
	Light Presence	Presence detector	theMura S180-101 UP WH	2060655
	Slave	Motion/presence detector	theMura S180 Slave UP WH	2060660
	Light (In combination with ELPA)	Motion detector	theMura S180-100 2W UP WH	2060670
–	Light	Motion detector	theMura S180-100 B UP	2060750
	Light Presence	Presence detector	theMura S180-101 B UP	2060755
	Slave	Motion/presence detector	theMura S180 Slave B UP	2060760
	Light (In combination with ELPA)	Motion detector	theMura S180-100 2W B UP	2060770

Presence and motion detectors/LED spotlights

Motion detectors



Technical data

	theMura S180-100	theMura S180-101	theMura S180 Slave	theMura S180-100 2W
Operating voltage	230 V AC			
Frequency	50–60 Hz			
Standby output	0.4 W			
Brightness setting range	5–1000 lx	5–3000 lx	–	5–1000 lx
Lighting time delay	10 s – 30 min/pulse	10 s – 60 min/pulse	–	Pulse
Incandescent/halogen lamp load	2300 W			–
LED lamp (typ.)	< 2 W = 40 W > 2 W = 450 W			–
Presence switch-on delay	–	0 s–10 min	–	–
Presence time delay	–	10 s–120 min	–	–
Switching capacity presence	–	50 W / 50 VA	–	–
Ambient temperature	–15 °C ... +45 °C			
Protection rating	IP 20			

Detection area

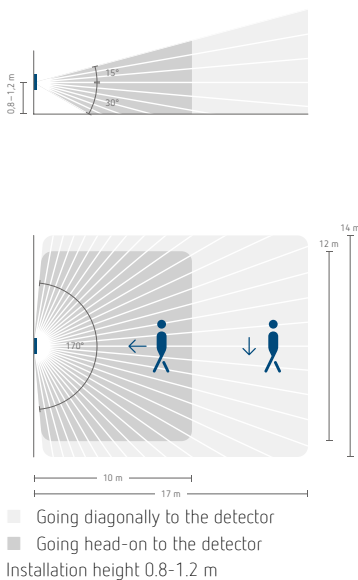

Connection examples

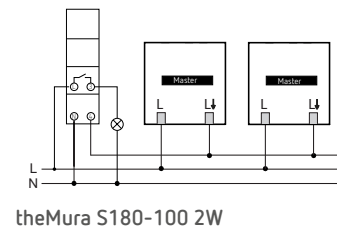
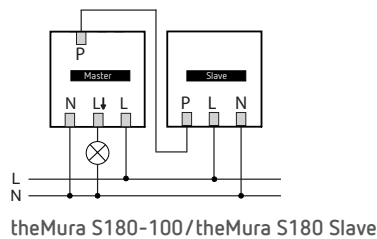
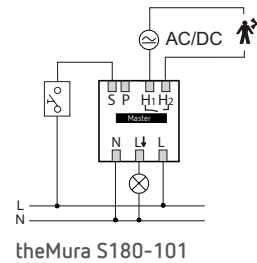
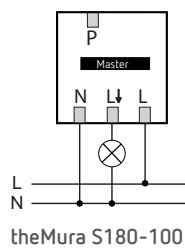

Dimensions

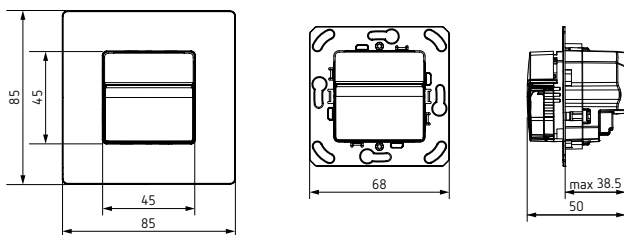

Accessories

theSenda B
 Details page 359
theSenda P
 Details page 359

theSenda S
 Details page 359
Cover frames theMura
 Details page 357

Application example

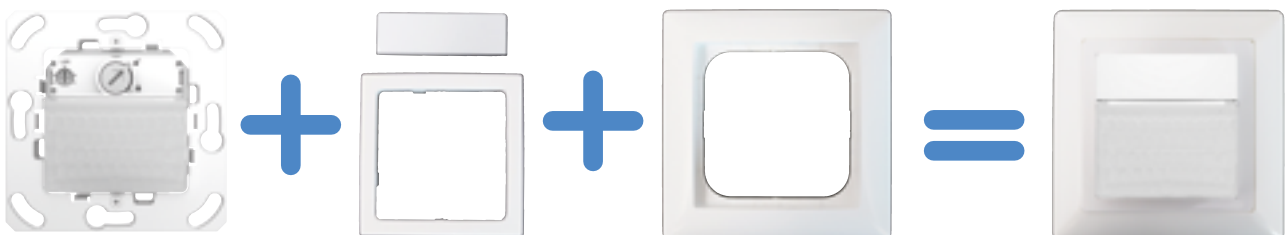

Presence and motion detectors/LED spotlights

Motion detectors



Description

- Motion detector (PIR)
- Automatic lighting control based on presence and brightness
- 2 wire connection, ideal for retrofitting
- Light switch output (triac, 230 V AC)
- Mixed light measurement suitable for incandescent and halogen lamps (no electronic ballast)
- Advance shut-off warning through dimming 15 seconds before light switches off
- Wall installation
- Compatible with branded switches, replaces conventional light switches
- Area limit via lens attachment
- Manual AUTO/ON/OFF switching by simple adjustment of cover flap
- Teach-in of current brightness value
- Instant start-up possible via factory preset
- No unintentional adjustment due to covered up controls
- Adjustable brightness switching value and switch-off delay
- Sensitivity can be reduced to limit detection area
- Pulse function

Product selection

Installation type	Channel	Colour	Detection angle	Type	Article number
Flush-mounted wall installation	Light	White	200°, circular	LUXA 103-200 T	1030031

Technical data

	LUXA 103-200 T
Operating voltage	230 V AC
Frequency	50 Hz
Stand-by consumption	0,7 W
Setting range brightness	10 – 1000 lx Infinitely adjustable
Switching capacity light	2 A (at 230 V AC, $\cos \varphi = 1$)
Detection angle	200°, circular
Installation height	1,2 – 2 m
Light switch-off delay	20 s – 30 min
Incandescent lamp load	400 W
Fluorescent lamp load (conventional) parallel-corrected	400 VA, 42 μ F
Ambient temperature	0 °C ... +45 °C
Protection class	II
Type of protection	IP 40

Detection range (Semicircular)

Mounting height (A)	Head on to (r)	Diagonally (t)
1,2 – 2 m	3,5 m	8 m

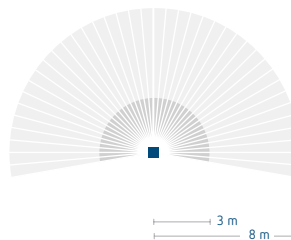

Accessories



Surface frame LUXA 103-200
↳ Art.No.: 9070504
Details page 357



RC filter
↳ Art.No.: 9070523
Details page 355



Scale drawings

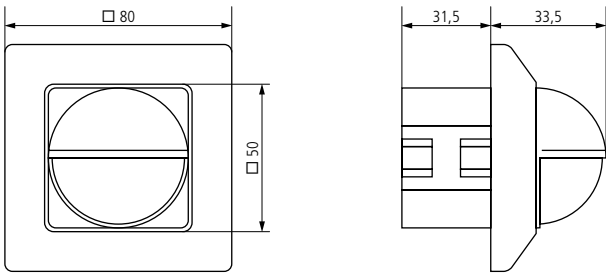

Connection diagrams

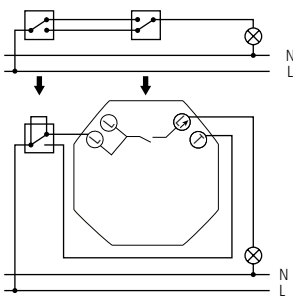

LUXA 103-200 T

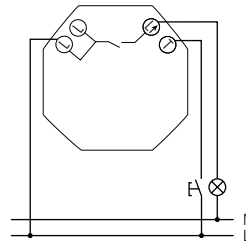

LUXA 103-200 T



A clear line theLuxa R, S and P motion detectors



Most people wouldn't even notice them. Or only at the point when the light comes on, a feeling of safety abounds and everyone can see the way: theLuxa motion detectors from Theben.

They contribute decisively to saving energy as well as increasing comfort and safety. The light is automatically switched on when needed, and only then. theLuxa always shows its best side – whether in white (WH) or in black (BK). Whatever wall it is on. Or even on the ceiling – thanks to the swivel joint on some versions.



theLuxa is available in the standard versions R180, S150/S180 and S360, or as a remote-controlled Performance version with floating contacts for simple, time-saving and thus inexpensive integration into KNX building system technology. For further information and technical data, see the pages that follow.

Presence and motion detectors/Spotlights

Outdoor motion detectors

	Installation tyoe	Detection angle	Detection range	Channel	LED lamps	Remote controllable	Type	Page
Outdoor								
	Wall	180°	12 m	Light	150 W	–	theLuxa E180	214
		180°	12 m	Light	500 W	–	theLuxa R180	216
		150°	12 m	Light	500 W	–	theLuxa S150	218
		180°	12 m	Light	500 W	–	theLuxa S180	218
	Wall or ceiling	360°	16 m	Light	500 W	–	theLuxa S360	220
		220°	16 m	Light	600 W	✓	theLuxa P220	222
		300°	16 m	Light	500 W	✓	theLuxa P300	222



Presence and motion detectors/LED spotlights

Motion detectors, outdoor



Description

Common functions

- Motion detector (PIR)
- Automatic lighting control based on presence and brightness
- 180° detection angle
- For outdoor use
- Sensor head can be turned by $\pm 90^\circ$ horizontally and by 30° downwards/upwards
- Adjustable brightness switching value and switch-off delay
- Mixed light measurement suitable for the control of fluorescent, incandescent, halogen lamps and LEDs
- Area limit via stickers
- Test function for checking detection area
- Single-handed plug-in installation

Product selection

Installation type	Channel	Detection angle	Colour	Type	Article number
Wall installation	Light	180°	White	theLuxa E180 WH	1010205
			Black	theLuxa E180 BK	1010206

Technical data

	theLuxa E180
Operating voltage	230 V AC
Frequency	50
Stand-by consumption	< 1 W
Setting range brightness	5 – 1000 lx
Switching capacity light	10 A (at 230 V AC, $\cos \varphi = 1$)
Detection angle	180°
Light switch-off delay	5 s – 15 min
Incandescent lamp load	2300 W
Fluorescent lamp load (conventional) parallel-corrected	350 VA, 37 μ F
Fluorescent lamp load (conventional) series-corrected	400 VA
LED lamp < 2 W (typ.)	50 W
LED lamp 2 – 8 W (typ.)	150 W
LED lamp > 8 W (typ.)	150 W
Ambient temperature	-20 °C ... +40 °C
Protection class	II
Type of protection	IP 55

Presence and motion detectors/LED spotlights

Motion detectors, outdoor

Detection range (Semicircular)

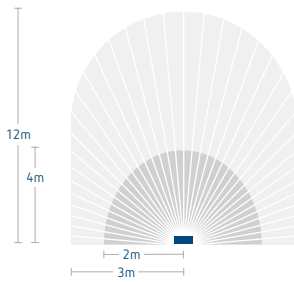

- Walking diagonally to the detector
 - Walking head on to the detector
- Mounting height: 2.5 m

Accessories



Corner angle theLuxe E WH
↳ Art.No.: 9070974
Details page 355



Corner angle theLuxe E BK
↳ Art.No.: 9070975
Details page 355

Scale drawings

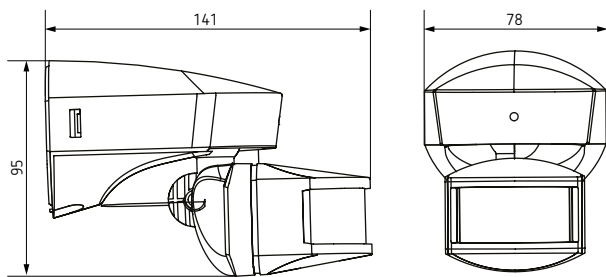

Connection diagrams

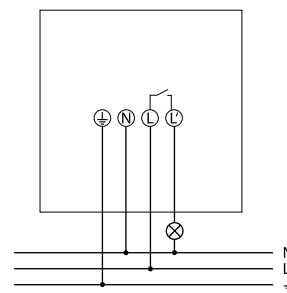

Presence and motion detectors/LED spotlights

Motion detectors, outdoor

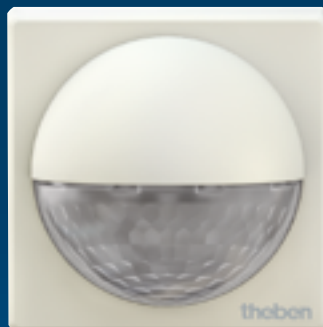

theLuxa R180 WH

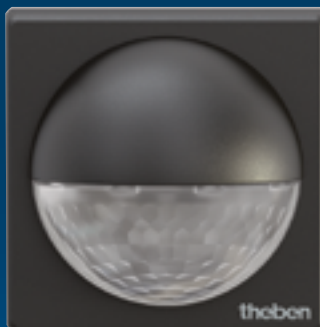

theLuxa R180 BK

Description

- Motion detector (PIR)
- Automatic lighting control based on presence and brightness
- 180° detection angle
- For outdoor use
- Protection from tampering thanks to the robust case design
- Compact dimensions
- Covered operating controls under the secured front cover
- Adjustable brightness switching value and switch-off delay
- Area limit via lens attachment
- Zero-cross switching for relay-saving switching and high lamp loads
- Test function for checking detection area
- Installation on flush-mounted socket possible (60 mm)
- Single-handed plug-in installation
- Instant start-up possible via factory preset
- Terminal for protective earth conductor

Product selection

Installation type	Channel	Detection angle	Colour	Type	Article number
Wall installation	Light	180°	White	theLuxa R180 WH	1010200
			Black	theLuxa R180 BK	1010201

Technical data

	theLuxa R180 WH	theLuxa R180 BK
Operating voltage	230 V AC	
Frequency	50–60 Hz	
Stand-by consumption	< 0,5 W	
Installation height	2,5	
Detection angle	180°	
Switching capacity light	10 A (at 230 V AC, $\cos \varphi = 1$)	
Setting range brightness	2–200 lx/ ∞	
Light switch-off delay	2 s–30 min	
Incandescent lamp load	2300 W	
Energy saving lamps	500 W	
LED lamp < 2 W (typ.)	50 W	
LED lamp > 2 W (typ.)	500 W	
Ambient temperature	–25 °C ... +45 °C	
Protection class	II	
Type of protection	IP 55	

Presence and motion detectors/LED spotlights

Motion detectors, outdoor

Detection range (Semicircular)

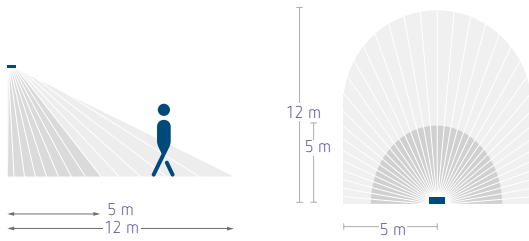

- Walking diagonally to the detector
 - Walking head on to the detector
- Mounting height: 2.5 m

Accessories



Spacer 10 WH
Details page 357

Corner angle 10 BK
Details page 356

Spacer 10 BK
Details page 357

Corner angle 10 WH
↳ Art.No.: 9070969
Details page 356

Scale drawings

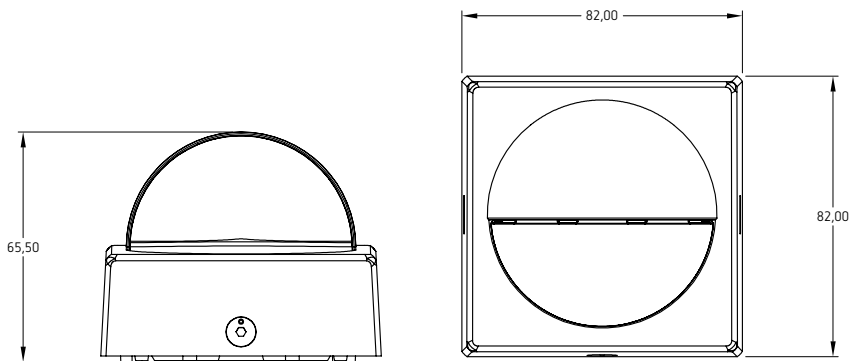

Connection diagrams

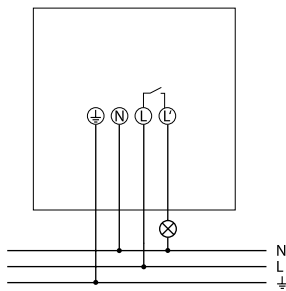

Presence and motion detectors/LED spotlights

Motion detectors, outdoor



Description

Common functions

- Motion detector (PIR)
- Automatic lighting control based on presence and brightness
- For outdoor use
- Additional creep under protection
- Sensor head can be turned by $\pm 90^\circ$ horizontally and by 30° downwards
- Adjustable brightness switching value and switch-off delay
- Zero-cross switching for relay-saving switching and high lamp loads
- Teach-in of current brightness value possible
- Pulse function
- Test function for checking detection area
- Installation on flush-mounted socket possible (60 mm)
- Single-handed plug-in installation
- Instant start-up possible via factory preset
- Controls are place protected
- Terminal for protective earth conductor

Product selection

Installation type	Channel	Detection angle	Colour	Type	Article number
Wall installation	Light	150°	White	theLuxa S150 WH	1010500
			Black	theLuxa S150 BK	1010501
		180°	White	theLuxa S180 WH	1010505
			Black	theLuxa S180 BK	1010506

Technical data

	theLuxa S150	theLuxa S180
Operating voltage	230 V AC	
Frequency	50 Hz	
Stand-by consumption	0,9 W	
Setting range brightness	5 – 1000 lx	
Switching capacity light	10 A (at 230 V AC, $\cos \varphi = 1$), 6 A (at 230 V AC, $\cos \varphi = 0.6$), 3 AX (at 230 V AC, $\cos \varphi = 0.3$)	
Detection angle	150°	180°
Light switch-off delay	1 s – 20 min	
Incandescent lamp load	2300 W	
Energy saving lamps	150 W	
LED lamp < 2 W (typ.)	50 W	
LED lamp > 2 W (typ.)	500 W	
Ambient temperature	-25 °C ... +45 °C	
Protection class	II	
Type of protection	IP 55	

Presence and motion detectors/LED spotlights

Motion detectors, outdoor

Detection range (Semicircular)

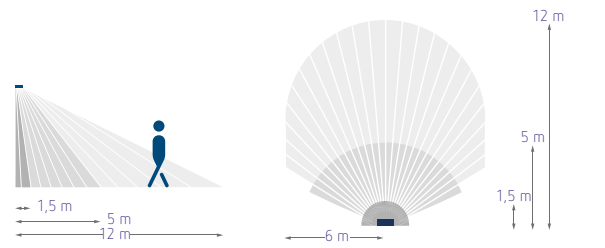

theLuxa S150

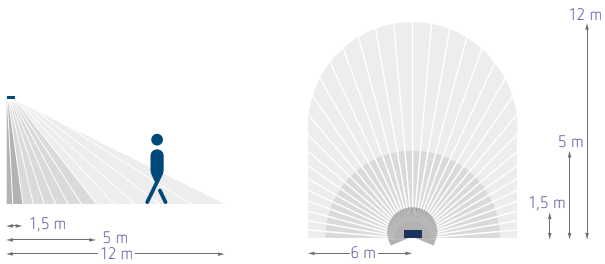

theLuxa S180

- Walking diagonally to the detector
 - Walking head on to the detector
 - Creep under protection
- Mounting height: 2.5 m



Accessories



Corner angle theLuxa S WH
↳ Art.No.: 9070902
Details page 356



Spacer theLuxa S WH
↳ Art.No.: 9070906
Details page 355



Corner angle theLuxa S BK
↳ Art.No.: 9070903
Details page 356



Spacer theLuxa S BK
↳ Art.No.: 9070907
Details page 355

Scale drawings

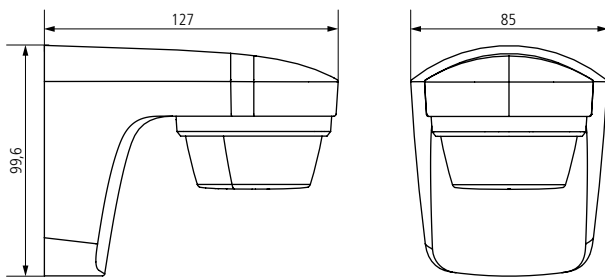

Connection diagrams

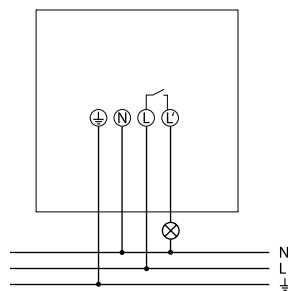

Presence and motion detectors/LED spotlights

Motion detectors, outdoor



theLuxa S360 WH

theLuxa S360 BK

Description

Common functions

- Motion detector (PIR)
- Automatic lighting control based on presence and brightness
- For outdoor use
- For installation on walls and ceilings
- 360° detection angle
- Sensor head can be turned by $\pm 90^\circ$ horizontally, by 45° downwards and by 90° upwards
- Adjustable brightness switching value and switch-off delay
- Sensitivity can be reduced to limit detection area
- Area limit via lens attachment
- Zero-cross switching for relay-saving switching and high lamp loads
- Teach-in of current brightness value possible
- Pulse function
- Test function for checking detection area
- Installation on flush-mounted socket possible (60 mm)
- Single-handed plug-in installation
- Instant start-up possible via factory preset
- Controls are place protected
- Terminal for protective earth conductor
- Corner angle included in delivery

Product selection

Installation type	Channel	Detection angle	Colour	Type	Article number
Wall and ceiling installation	Light	360°	White	theLuxa S360 WH	1010510
			Black	theLuxa S360 BK	1010511

Technical data

	theLuxa S360
Operating voltage	230 V AC
Frequency	50 Hz
Stand-by consumption	0,5 W
Setting range brightness	5 – 1000 lx
Switching capacity light	10 A (at 230 V AC, $\cos \varphi = 1$), 6 A (at 230 V AC, $\cos \varphi = 0.6$), 3 AX (at 230 V AC, $\cos \varphi = 0.3$)
Detection angle	360°
Light switch-off delay	1 s – 20 min
Incandescent lamp load	2300 W
Energy saving lamps	150 W
LED lamp < 2 W (typ.)	50 W
LED lamp > 2 W (typ.)	500W
Ambient temperature	-25 °C ... +45 °C
Protection class	II
Type of protection	IP 66

Detection range (Round)

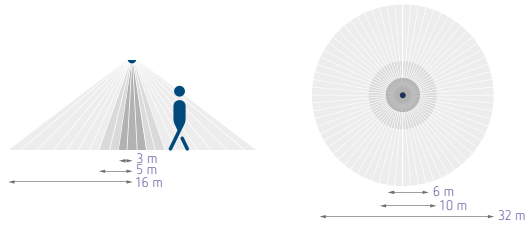

- Walking diagonally to the detector
 - Walking head on to the detector
 - Creep under protection
- Mounting height: 2.5 m

Accessories



Spacer theLuxe S WH
↳ Art.No.: 9070906
Details page 355



Spacer theLuxe S BK
↳ Art.No.: 9070907
Details page 355



Scale drawings

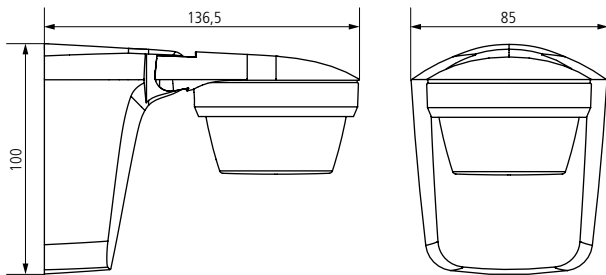

Connection diagrams

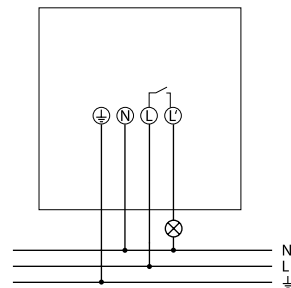

Presence and motion detectors/LED spotlights

Motion detectors, outdoor



Description

Common functions

- Motion detector (PIR)
- Automatic lighting control based on presence and brightness
- For outdoor use
- For installation on walls and ceilings
- Additional creep under protection
- For larger, commercial outdoors properties such as offices, public buildings, hotels, schools, car parks and warehouses
- Adjustable brightness switching value and switch-off delay
- Sensor head can be turned by $\pm 90^\circ$ horizontally, by 45° downwards and by 90° upwards
- Remote-controllable

- Sensitivity can be reduced to limit detection area
- Area limit via lens attachment
- Potential-free relay with tungsten pre-contact for relay-saving switching and high lamp loads
- Teach-in of current brightness value possible
- Pulse function
- Test function for checking detection area
- Installation on flush-mounted socket possible (60 mm)
- Single-handed plug-in installation
- Instant start-up possible via factory preset
- Controls are place protected

- Terminal for protective earth conductor
- Switching of FELV (Functional Extra Low Voltage) possible

theLuxa P220

- 220° detection angle
- Spacer included in delivery

theLuxa P300

- 300° detection angle
- Spacer and corner angle included in delivery

Product selection

Installation type	Channel	Detection angle	Colour	Type	Article number
Wall and ceiling installation	Light	220°	White	theLuxa P220 WH	1010605
			Black	theLuxa P220 BK	1010606
		300°	White	theLuxa P300 WH	1010610
			Black	theLuxa P300 BK	1010611

Technical data

	theLuxa P220	theLuxa P300
Operating voltage	230 V AC	
Frequency	50 Hz	
Stand-by consumption	0,3 W	
Setting range brightness	5 – 1000 lx	
Switching capacity light	10 A (at 230 V AC, $\cos \varphi = 1$), 10 AX (at 230 V AC, $\cos \varphi = 0.3$)	
Detection angle	220°	300°
Light switch-off delay	1 s – 20 min	
Incandescent lamp load	2300 W	
Energy saving lamps	300 W	
LED lamp < 2 W (typ.)	60 W	
LED lamp > 2 W (typ.)	600 W	

Presence and motion detectors/LED spotlights

Motion detectors, outdoor

	theLuxa P220	theLuxa P300
Ambient temperature	-25 °C ... +45 °C	
Protection class	II	
Type of protection	IP 55	

Detection range (Semicircular)

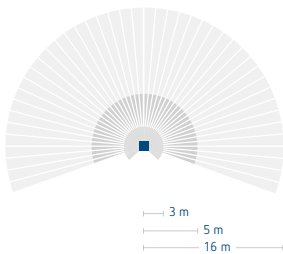

theLuxa P220

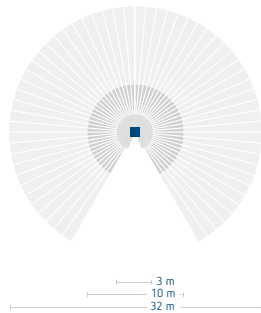

theLuxa P300

- Walking diagonally to the detector
 - Walking head on to the detector
 - Creep under protection
- Mounting height: 2.5 m



Accessories



Corner angle theLuxa P WH

↳ Art.No.: 9070904
Details page 356



Corner angle theLuxa P BK

↳ Art.No.: 9070905
Details page 356



theSenda P

↳ Art.No.: 9070910
Details page 359



theSenda S

↳ Art.No.: 9070911
Details page 359

Scale drawings

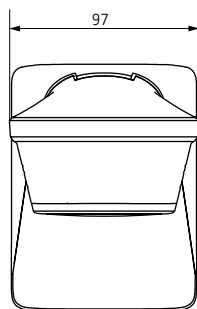
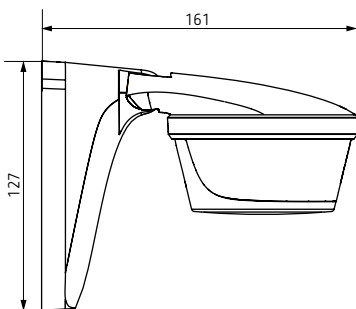

Connection diagrams

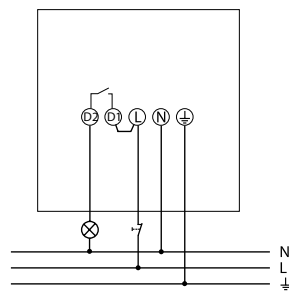

Uniform yet diverse: theLeda D LED light









Whether you are looking for indirect lighting for your house facade or impressive illumination for your garden, front door or patio, you need look no further than theLeda D. With their matt anodised aluminium housing and pleasant warm white light, these LED lights look stunning wherever they are used.



The theLeda D line offers you plenty of flexibility. You can choose between direct lighting with LED spotlights, indirect lighting with uplighters and downlighters and two bollard lights in different lengths. There is also the option of a practical socket on the rear. And the best part is that no matter which model you opt for, you are always guaranteed a uniform look for your home. All theLeda D models are available with or without an integrated motion detector. Further information and technical data on page 236 onwards.

Presence and motion detectors/Spotlights

Spotlights with/without motion detector

Installation tyoe	Detection angle	Detection range	Remote controllible	Type	Page
 Wall	–	–	(√)	theLeda B20L/B30L/ B50L/B100L	226
	180°	10 m	–	theLeda S10	228
				theLeda S20	228
	–	–	–	theLeda S10L	230
				theLeda S20L	230
	180°	12 m	√	theLeda P12	232
				theLeda P24	232
	–	–	–	theLeda P12L	234
				theLeda P24L	234
	180°	10 m	√	theLeda D S AL theLeda D SU AL theLeda D U AL theLeda D UD AL	236
	–	–	–	theLeda D SL AL theLeda D SUL AL theLeda D UL AL theLeda D UDL AL	238
 Floor	180°	12 m	√	theLeda D B AL theLeda D B plus AL theLeda D B plus S AL	240
	–	–	–	theLeda D BL AL theLeda D BL plus AL	240



Presence and motion detectors

LED spotlights, Motion detector/light sensor as accessory



Description

Common functions

- LED spotlight
- Suitable for outdoor use
- Flexible extension options thanks to optional module with motion detector including switch output or light sensor incl. switch output
- Spotlight can be turned by 360°
- Not dimmable

theLeda B20L

- 20 W LED spotlight

theLeda B30L

- 30 W LED spotlight

theLeda B50L

- 50 W LED spotlight

theLeda B100L

- 100 W LED spotlight

theLeda B motion module RC

- theLeda B radio-controlled motion detector module
- 180° detection angle at 12 m range
- Additional light switch output
- Sensor can turned horizontally by $\pm 90^\circ$ and downwards/backwards by 90°
- IP 55 protection rating
- theLeda B remote control included in scope of supply for the motion detector module
- A remote control can be combined with different motion detector modules
- Up to 6 remote controls can be combined with a single motion detector module
- Remote control range up to 100 m on open air test site

theLeda B motion module

- 180° detection angle at 12 m range
- Additional light switch output
- Sensor can turned horizontally by $\pm 90^\circ$ and downwards/backwards by 90°
- Protection rating IP 55

theLeda B light module

- Duty cycle range: 2, 4, 6, 8 hours, on/ permanent on at night
- Switch-on brightness can be set from 2–200 lux
- Additional light switch output
- Protection rating IP 55

Produktauswahl

Installation type	LED	Colour	Type	Article number	
Wall mounting	20 W	White	theLeda B20L WH	1020683	
		Black	theLeda B20L BK	1020684	
	30 W	White	theLeda B30L WH	1020685	
		Black	theLeda B30L BK	1020686	
	50 W	White	theLeda B50L WH	1020687	
		Black	theLeda B50L BK	1020688	
	100 W	White	theLeda B100L WH	1020681	
		Black	theLeda B100L BK	1020682	
	-		White	Light module theLeda B WH	9070762
			Black	Light module theLeda B BK	9070763
White			Motion module theLeda B WH	9070760	
Black			Motion module theLeda B BK	9070761	
White			Motion module RC theLeda B WH	9070800	
Black			Motion module RC theLeda B WH	9070801	
Black			Remote control theLeda B	9070802	

Presence and motion detectors LED spotlights, Motion detector/light sensor as accessory

Technical data

	theLeda B20L WH	theLeda B20L BK	theLeda B30L WH	theLeda B30L BK	theLeda B50L WH	theLeda B50L BK	theLeda B100L WH	theLeda B100L BK
Operating voltage	230 V AC							
Frequency	50 Hz							
LED output (luminous flux)	1500 lm	1400 lm	2100 lm	2050 lm	3600 lm	3500 lm	10.200 lm	9.800 lm
Colour temperature	5000 K							
Service life	L80/B10/50,000 h							
Colour rendering index	CRI > 80							
Ambient temperature	-20 °C ... +40 °C							
Protection class	I							
Protection rating	IP 65							

Application example



Version 1:
LED spotlight

For lighting control via a switch or a button



Version 2:
LED spotlight with light sensor

For lighting-based lighting control



Version 3:
LED spotlight with motion detector

For motion- and lighting-based lighting control



Version 4:
LED spotlight with RC motion detector

For motion- and lighting-based lighting control

Each RC motion detector is supplied with a remote control

Scale drawings

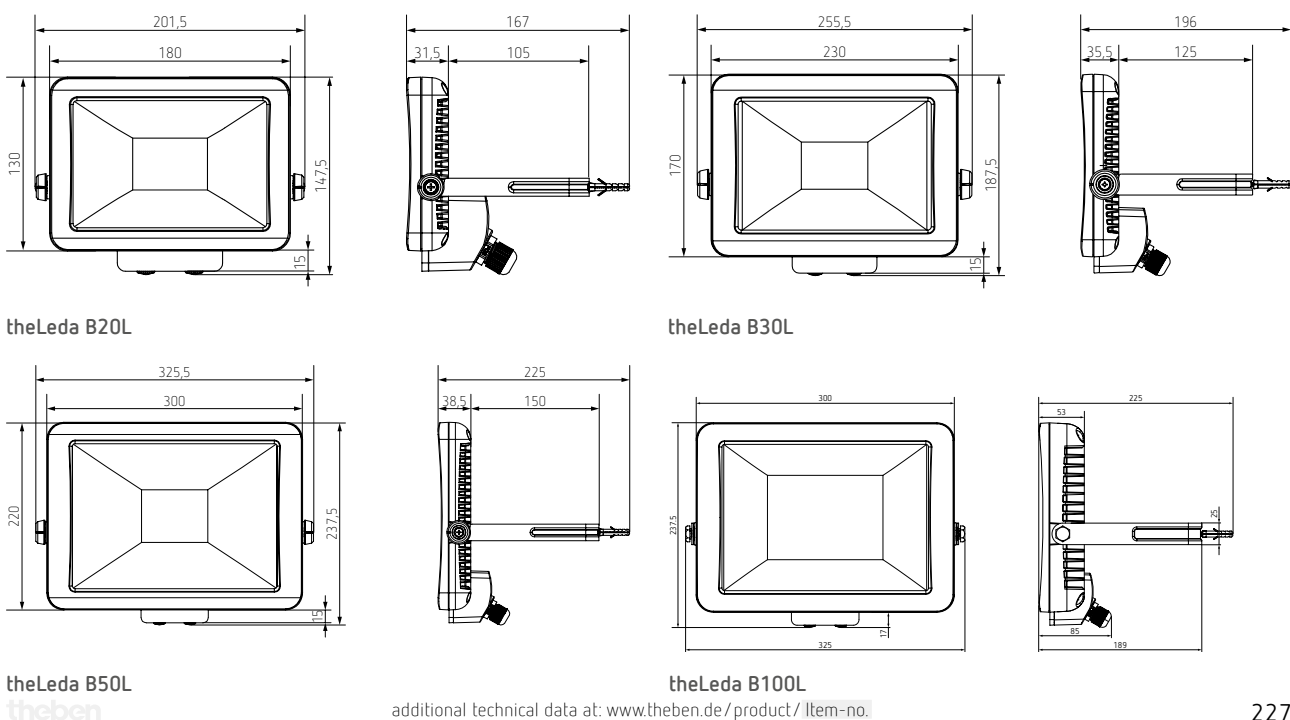

Presence and motion detectors

Spotlights, with motion detector

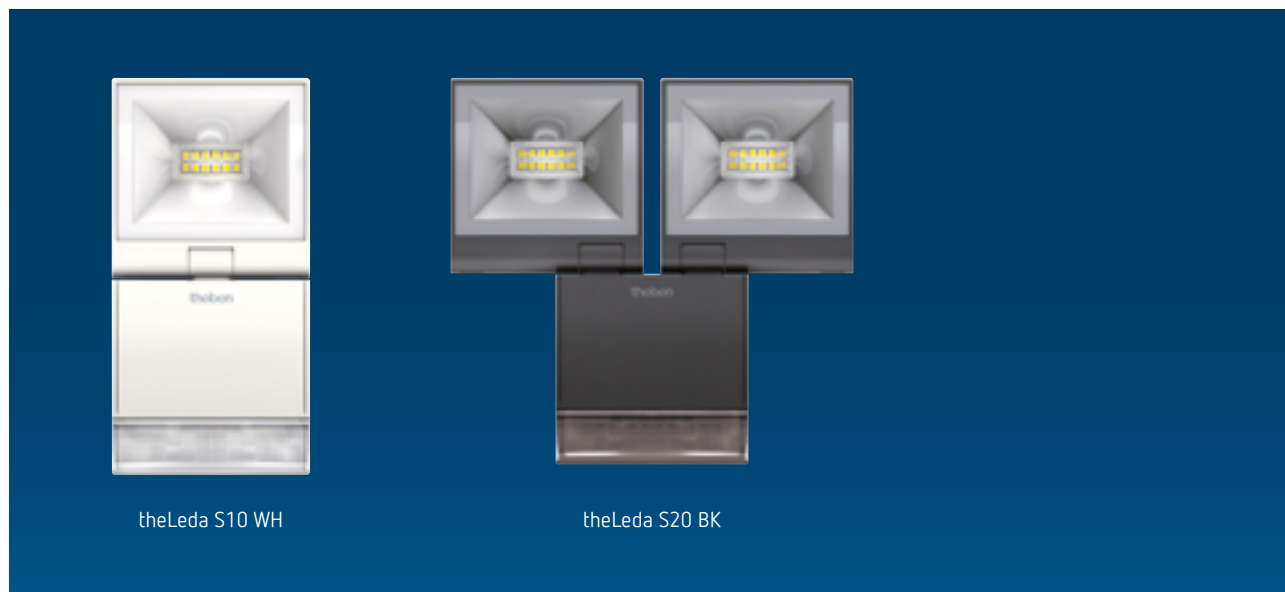

Description

Common functions

- LED spotlight with motion detector
- Suitable for outdoor use
- Automatic lighting control based on presence and brightness
- 180° detection angle at a detection range of 10 m
- Area limit via lens attachment
- Orientation light with configurable dimming level

- Short and extended function via manual control system
- Integrated heat sink in housing color
- Single-handed plug-in installation
- Instant start-up possible via factory preset
- Adjustable lux value and switch-off delay
- Setting elements easily accessible on the side

theLeda S10

- 1 LED spot with 10 W

- Spotlight can be swivelled $\pm 40^\circ$ horizontally, and adjusted 70° downwards, wall-wash functionality by swivelling 180°

theLeda S20

- 2 LED spot with 10 W each
- Spotlights can be swivelled $\pm 20^\circ$ horizontally, and adjusted 70° downwards

Product selection

Installation type	LED	Colour temperature	Colour	Type	Article number
Wall installation	10 W	4000 K, neutral white	White	theLeda S10 WH	1020921
			Black	theLeda S10 BK	1020922
	3000 K, warm white	White	theLeda S10 W WH	1020931	
		Black	theLeda S10 W BK	1020932	
	2 x 10 W	4000 K, neutral white	White	theLeda S20 WH	1020923
			Black	theLeda S20 BK	1020924
3000 K, warm white		White	theLeda S20 W WH	1020933	
		Black	theLeda S20 W BK	1020934	

Technical data

	theLeda S10	theLeda S10 W	theLeda S20	theLeda S20 W
Operating voltage	230 V AC			
Frequency	50–60 Hz			
Stand-by consumption	0,4 W			
Setting range brightness	5–200 lx			
LED output (lighting current)	840 lm	770 lm	2 x 840 lm	2 x 770 lm

Presence and motion detectors

Spotlights, with motion detector

	theLeda S10	theLeda S10 W	theLeda S20	theLeda S20 W
Colour temperature	4000 K, neutral white	3000 K, warmwhite	4000 K, neutral white	3000 K, warmwhite
Service life	L80/B10/20,000 h			
Colour rendering index	CRI > 80			
Detection angle	180°			
Installation height	1,8–2,5 m			
Light switch-off delay	2 s–30 min			
Ambient temperature	–20 °C ... +45 °C			
Protection class	I			
Type of protection	IP 55			

Detection range (Semicircular)

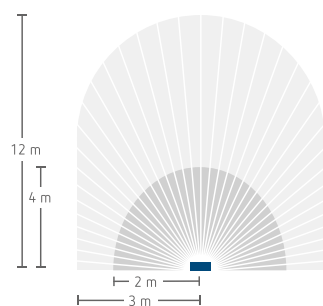

- Walking diagonally to the detector
 - Walking head on to the detector
- Mounting height: 2.5 m

Connection diagrams

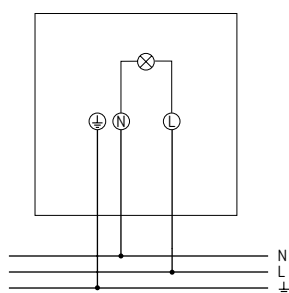

Accessoires



Corner angle 10 WH
↳ Art.No.: 9070969
Details page 356



Spacer 10 WH
↳ Art.No.: 9070971
Details page 357



Corner angle 10 BK
↳ Art.No.: 9070987
Details page 356



Spacer 10 BK
↳ Art.No.: 9070988
Details page 357

Dimensions

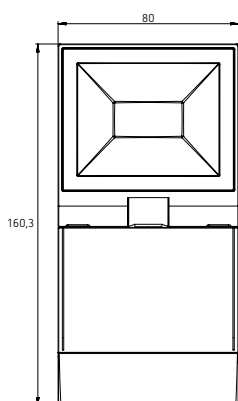

theLeda S10

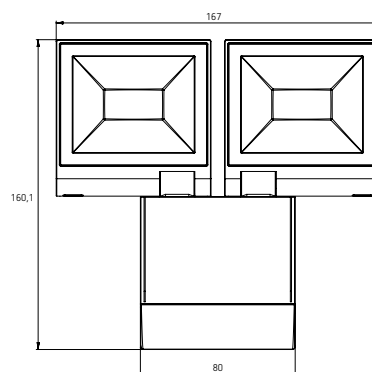
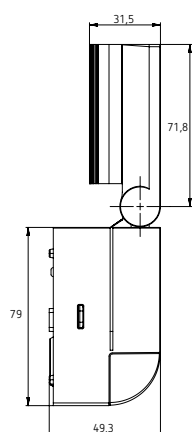

theLeda S20

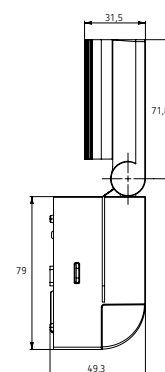

Presence and motion detectors

Spotlights

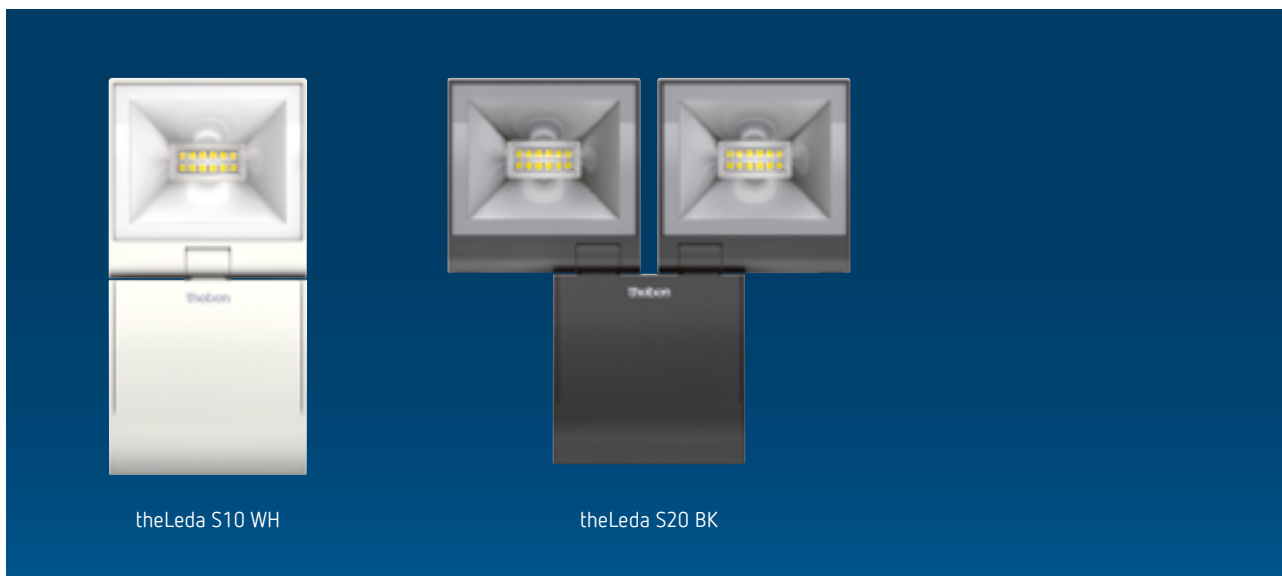

theLeda S10 WH

theLeda S20 BK

Description

Common functions

- LED spotlight
- Suitable for outdoor use
- Single-handed plug-in installation
- Integrated heat sink in housing color

theLeda S10L

- 1 LED spot with 10 W
- Spotlight can be swivelled $\pm 40^\circ$ horizontally, and adjusted 70° downwards, wall-wash functionality by swivelling 180°

theLeda S20L

- 2 LED spot with 10 W each
- Spotlights can be swivelled $\pm 20^\circ$ horizontally, and adjusted 70° downwards

Product selection

Installation type	LED	Colour	Type	Article number
Wall installation	10 W	White	theLeda S10L WH	1020721
		Black	theLeda S10L BK	1020722
	2 x 10 W	White	theLeda S20L WH	1020723
		Black	theLeda S20L BK	1020724

Technical data

	theLeda S10L	theLeda S20L
Operating voltage	230 V AC	
Frequency	50–60 Hz	
LED output (lighting current)	840 lm	2 x 840 lm
Colour temperature	4000 K, neutral white	
Service life	L80/B10/20,000 h	
Colour rendering index	CRI > 80	
Installation height	1,8–2,5 m	
Ambient temperature	–20 °C ... +45 °C	
Protection class	II	
Type of protection	IP 55	

Accessoires



Corner angle 10 WH
↳ Art.No.: 9070969
Details page 356



Spacer 10 WH
↳ Art.No.: 9070971
Details page 357



Corner angle 10 BK
↳ Art.No.: 9070987
Details page 356



Spacer 10 BK
↳ Art.No.: 9070988
Details page 357

Connection diagrams

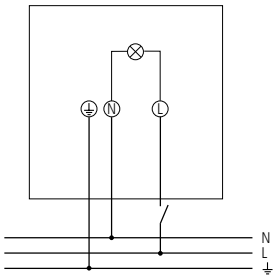

theLeda S L



Dimensions

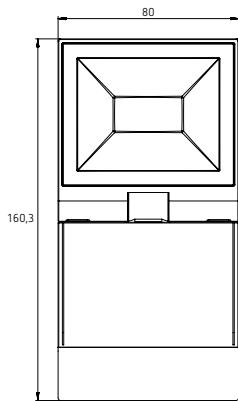

theLeda S10L

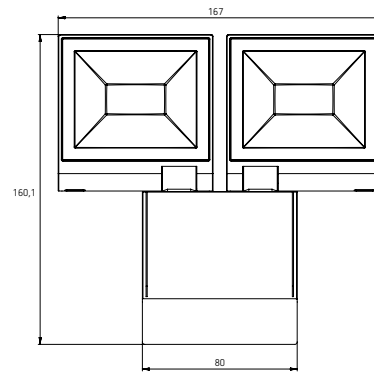
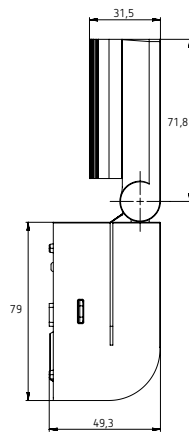

theLeda S20L

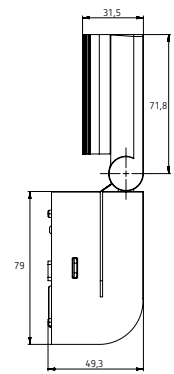

Presence and motion detectors

Spotlights, with motion detector



theLeda P12 WH

theLeda P24 AL

Description

Common functions

- LED light with motion detector
- Suitable for outdoor use
- Automatic lighting control based on presence and brightness
- 180° detection angle at a detection range of 12 m and creep under protection
- Diffused glare-free light
- Functions teach-in, test, twilight switch, dimmable orientation light and night interruption adjustable
- Area limit via lens attachment

- Controls are place protected
- Remote controllable with optionally remote controls theSenda P and theSenda S
- Back side made of high-quality aluminum die-cast for an optimally cooling of the high-power LEDs

theLeda P12

- 11 W (900 lm)
- Spotlight can be swivelled 35° left/right, 60° upwards/downwards and 180° backwards
- Spacer included in delivery

theLeda P24

- 20 W (2 x 900 lm)
- Spotlight can be swivelled 30° backwards, 60° downwards
- Spacer and corner angle included in delivery

Product selection

Installation type	LED	Colour	Type	Article number
Wall installation	11 W (900 lm)	White	theLeda P12 WH	1020941
		Aluminium	theLeda P12 AL	1020942
	20 W (2 x 900 lm)	White	theLeda P24 WH	1020943
		Aluminium	theLeda P24 AL	1020944

Technical data

	theLeda P12	theLeda P24
Operating voltage	230 V AC	
Frequency	50–60 Hz	
Stand-by consumption	0,4 W	
Setting range brightness	5–800 lx or just presence dependent	
LED output (lighting current)	11 W (900 lm)	20 W (2 x 900 lm)
Colour temperature	4000 K, neutral white	
Service life	L80/B10/50,000 h	
Colour rendering index	CRI > 80	
Detection angle	180°	
Installation height	1,8–2,5 m	
Light switch-off delay	10 s–20 min	
Ambient temperature	–25 °C ... +45 °C	

Presence and motion detectors Spotlights, with motion detector

	theLeda P12	theLeda P24
Protection class	II	
Type of protection	IP 55	

Detection range (Semicircular)

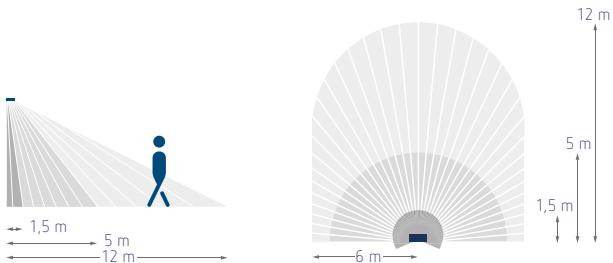

Accessories



theSenda P

↳ Art.No.: 9070910
Details page 359



theSenda S

↳ Art.No.: 9070911
Details page 359

Corner angle 10 WH

Details page 356

Spacer 10 WH

Details page 357

Corner angle 10 AL

Details page 356

Spacer 10 AL

Details page 356



Scale drawings

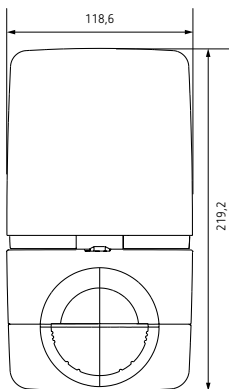

theLeda P12

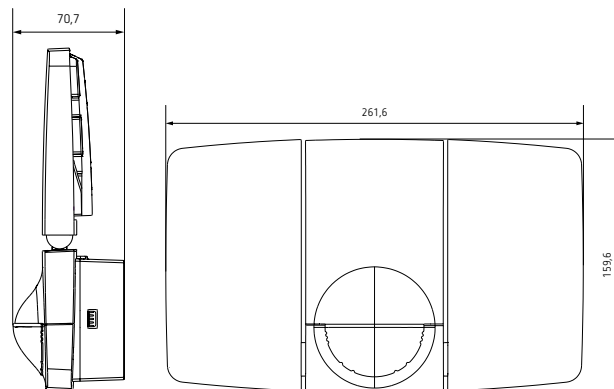

theLeda P24

Connection diagrams

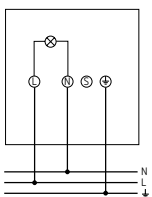

theLeda P12, theLeda P24
(Standard operation)

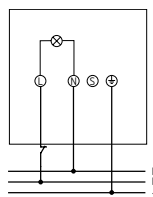

theLeda P12, theLeda P24
(Manual operation via circuit
breaker button)

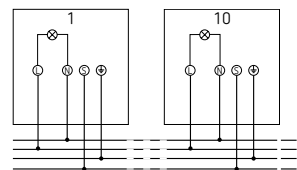

theLeda P12, theLeda P24
(Connection Master/Master)

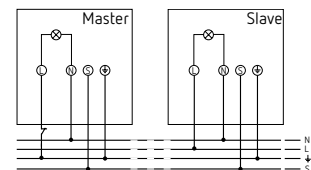

Master/Slave

Presence and motion detectors

Spotlights



Description

Common functions

- LED light
- Suitable for outdoor use
- Diffused glare-free light
- Back side made of high-quality aluminum die-cast for an optimally cooling of the high-power LEDs

theLeda P12L

- 11 W (900 lm)
- Spotlight can be swivelled 35° left/right, 60° upwards/downwards and 180° backwards
- Spacer included in delivery

theLeda P24L

- 20 W (2 x 900 lm)
- Spotlight can be swivelled 30° backwards, 60° downwards
- Spacer and corner angle included in delivery

Product selection

Installation type	LED	Colour	Type	Article number
Wall installation	11 W (900 lm)	White	theLeda P12L WH	1020741
		Aluminium	theLeda P12L AL	1020742
	20 W (2 x 900 lm)	White	theLeda P24L WH	1020743
		Aluminium	theLeda P24L AL	1020744

Technical data

	theLeda P12L	theLeda P24L
Operating voltage	230 V AC	
Frequency	50–60 Hz	
Stand-by consumption	0,4 W	
LED output (lighting current)	11 W (900 lm)	20 W (2 x 900 lm)
Colour temperature	4000 K, neutral white	
Service life	L80/B10/50,000 h	
Colour rendering index	CRI > 80	
Installation height	1,8–2,5 m	
Ambient temperature	–25 °C ... +45 °C	
Protection class	II	
Type of protection	IP 55	

Accessories



Corner angle 10 WH
↳ Art.No.: 9070969
Details page 356



Spacer 10 WH
↳ Art.No.: 9070971
Details page 357



Corner angle 10 AL
↳ Art.No.: 9070970
Details page 356



Spacer 10 AL
↳ Art.No.: 9070972
Details page 356

Scale drawings

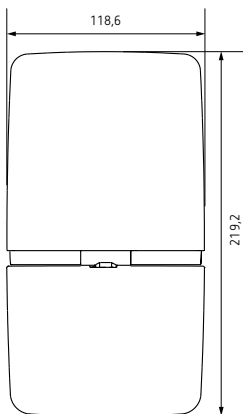

theLeda P12L

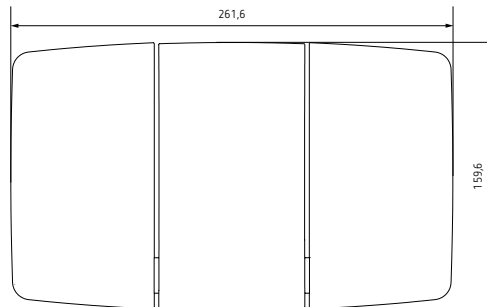
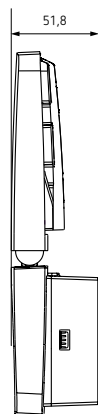

theLeda P24L

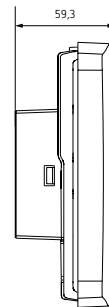

Connection diagrams

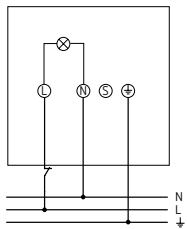

theLeda P12L, theLeda P24L

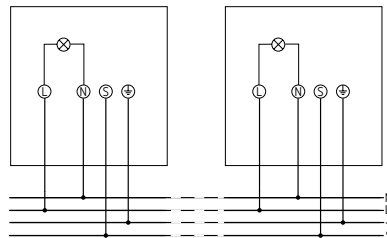

theLeda P12, theLeda P24L
(Connection Master/Slave)

Presence and motion detectors

LED light

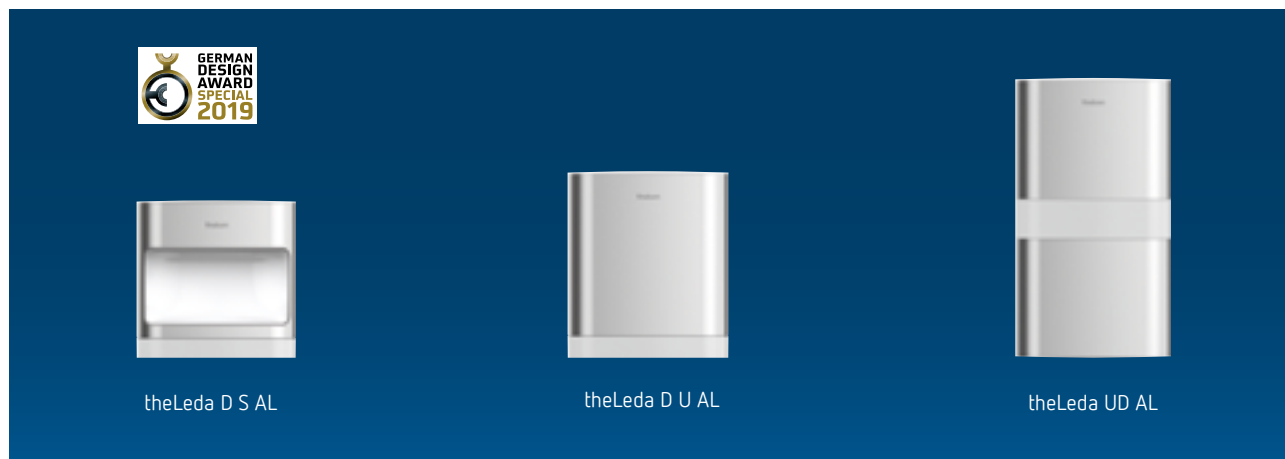

Description

Common functions

- Stylish LED light with motion detector (PIR)
- High-quality housing made from anodised extruded-aluminium profiles
- Suitable for outdoor use
- Automatic lighting control based on presence and brightness
- 180° detection angle at 10 m range
- Teach-in, test, twilight switch, dimmable orientation light and self-calculating night interruption functions can be adjusted
- High IP 55 protection rating for outdoor installation
- Easy installation with socket

- Wireless connectivity
- Long-lasting LEDs: service life of 50,000 hours
- Manual control via an interrupter switch (PERM ON 6 h)

theLeda D S AL

- 8.5 W LED light
- Light emission at front (spotlight)

theLeda D SU AL

- 14 W LED light
- Light emission at front (spotlight) and at top (uplighter)

theLeda D U AL

- 8.5 W LED light
- Light emission at top (uplighter)

theLeda D UD AL

- 11.5 W LED light
- Light emission at top (uplighter) and bottom (downlighter)

Product selection

Type of installation	Light emission	Colour	Type	Article number
Wall mounting	Spotlight (at front)	Aluminium	theLeda D S AL	1020901
	Spot/up-light (at front/top)	Aluminium	theLeda D SU AL	1020902
	Up-light (at top)	Aluminium	theLeda D U AL	1020903
	Up-light/down-light (at top/bottom)	Aluminium	theLeda D UD AL	1020904

Technical data

	theLeda D S AL	theLeda D SU AL	theLeda D U AL	theLeda D UD AL
Operating voltage	230 V AC			
Frequency	50–60 Hz			
Stand-by consumption	0,5 W			
Setting range brightness	2–800 lx			
LED output (lighting current)	760 lm	760 lm 475 lm	760 lm	2 x 475 lm
Colour temperature	3000 K, warmwhite			
Service life	L80/B10/50,000 h			
Colour rendering index	CRI > 80			
Light switch-off delay	10 s–20 min			
Ambient temperature	–25 °C ... +45 °C			
Protection class	II			
Type of protection	IP 55			

Detection area (semicircle)

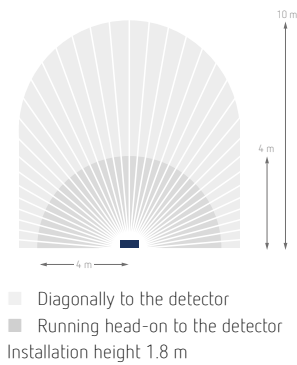

Connection example

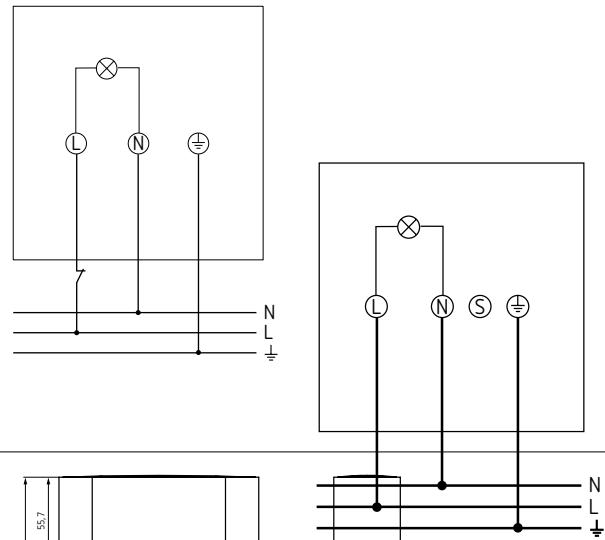

Scale drawings

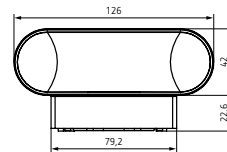
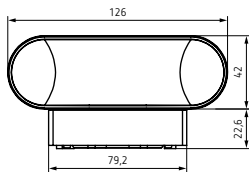
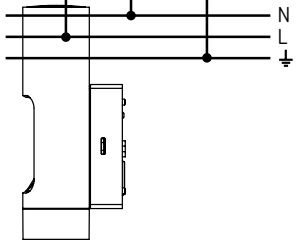
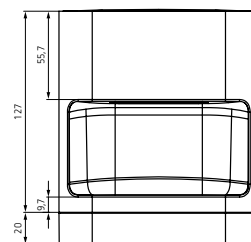
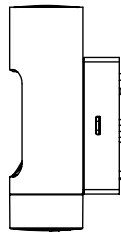
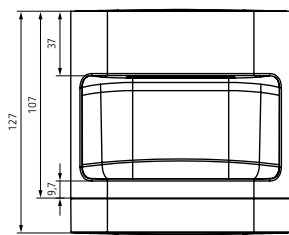

theLeda D S AL

theLeda D SU AL

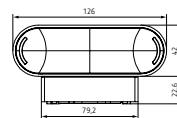
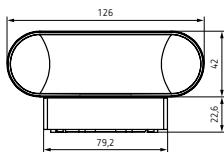
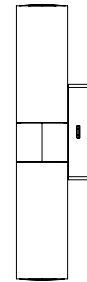
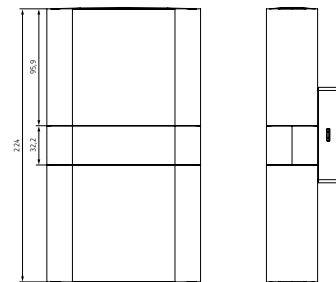
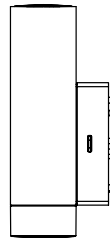
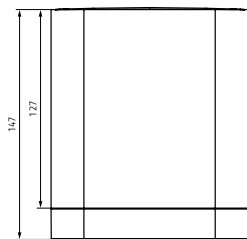

theLeda D U AL

theLeda D UD AL

Accessories



theSenda P

↳ Art.No.: 9070910
Details page 359



theSenda S

↳ Art.No.: 9070911
Details page 359



theSenda B

↳ Art.No.: 9070985
Details page 359

Spacer 10 AL

Details page 356

Corner angle 10 AL

Details page 356

Presence and motion detectors

LED light



Description

Common functions

- Stylish LED light
- High-quality housing made from anodised extruded-aluminium profiles
- Suitable for outdoor use
- High IP 55 protection rating for outdoor installation
- Easy installation with socket
- Wireless connectivity
- Long-lasting LEDs: service life of 50,000 hours

theLeda D SL AL

- Stylish LED light 8.5 W
- Light emission at front (spot-light)

theLeda D SUL AL

- Stylish LED light 14 W
- Light emission at front (spot-light) and at top (up-light)

theLeda D UL AL

- Stylish LED light 8.5 W
- Light emission at top (up-light)

theLeda D UDL AL

- Stylish LED light 11.5 W
- Light emission at top (up-light) and bottom (down-light)

Product selection

Type of installation	Light emission	Colour	Type	Article number
Wall mounting	Spotlight (at front)	Aluminium	theLeda D SL AL	1020701
	Spot/up-light (at front/top)	Aluminium	theLeda D SUL AL	1020702
	Up-light (at top)	Aluminium	theLeda D UL AL	1020703
	Up-light/down-light (at top/bottom)	Aluminium	theLeda D UDL AL	1020704

Technical data

	theLeda D SL AL	theLeda D SUL AL	theLeda D UL AL	theLeda D UDL AL
Operating voltage	230 V AC			
Frequency	50–60 Hz			
Stand-by consumption	0,5 W			
LED output (lighting current)	760 lm	760 lm 475 lm	760 lm	2 x 475 lm
Colour temperature	3000 K, warmwhite			
Service life	L80/B10/50,000 h			
Colour rendering index	CRI > 80			
Ambient temperature	–25 °C ... +45 °C			
Protection class	II			
Type of protection	IP 55			

Connection example

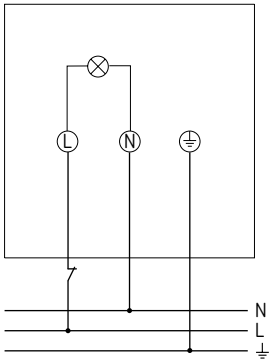

Accessories



Corner angle 10 AL
↳ Art.No.: 9070970
Details page 356



Spacer 10 AL
↳ Art.No.: 9070972
Details page 356

Scale drawings

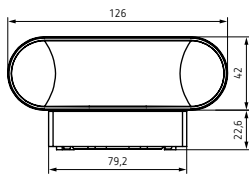
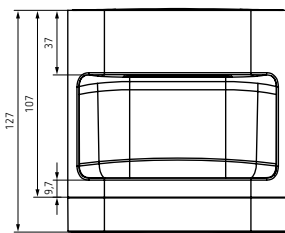

theLeda D SL AL

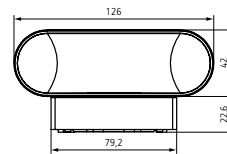
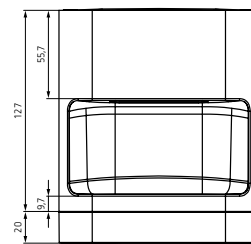

theLeda D SUL AL

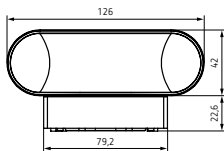
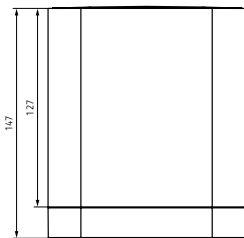

theLeda D UL AL

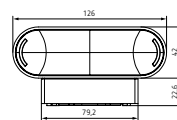
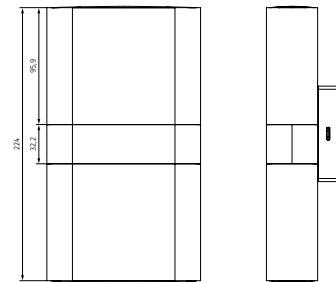

theLeda D UDL AL

Presence and motion detectors

LED bollard light, with/without motion detector



Description

Common functions

(theLeda D with motion detector)

- Stylish LED bollard light with motion detector (PIR)
- High-quality housing made from anodised extruded-aluminium profiles
- Suitable for outdoor use
- Automatic lighting control based on presence and brightness
- 180° detection angle with 12 m diameter, optimised for paths
- Teach-in, test, twilight switch, dimmable orientation light and self-calculating night interruption functions can be adjusted
- Can be adjusted via the theSenda S and P remote controls, via theSenda B and the theSenda Plug app, or by setting the potentiometer on the device itself
- High IP 55 protection rating for outdoor installation (with IP 54 socket)

- Wireless connectivity, can only be set via theSenda B with theSenda Plug
- Exceptionally efficient thanks to high light output
- Long-lasting LEDs: service life of 50,000 hours
- Manual control via an interrupter switch (PERM ON 6 h)

theLeda D B AL

- 8,5 W short LED bollard light
- Light emission at front (spotlight)

theLeda D B plus AL

- 8,5 W long LED bollard light
- Light emission at front (spotlight)

theLeda D B plus S AL

- 8,5 W long LED bollard light
- Light emission at front (spotlight)
- With socket on the back of the housing

Common functions

(theLeda D without motion detector)

- Stylish LED bollard light
- High-quality housing made from anodised extruded-aluminium profiles
- Suitable for outdoor use
- High IP 55 protection rating for outdoor installation
- Wireless connectivity, can only be set via theSenda B with theSenda Plug
- Exceptionally efficient thanks to high light output
- Long-lasting LEDs: service life of 50,000 hours

theLeda D BL AL

- 8,5 W short LED bollard light
- Light emission at front (spotlight)

theLeda D BL plus AL

- 8,5 W long LED bollard light
- Light emission at front (spotlight)

Product selection

Type of installation	With motion detector	Version	With socket	Colour	Type	Article number
Floor installation	✓	Short	-	Aluminium	theLeda D B AL	1020905
		Long	-	Aluminium	theLeda D B plus AL	1020906
		Long	✓	Aluminium	theLeda D B plus S AL	1020907
-	-	Short	-	Aluminium	theLeda D BL AL	1020705
		Long	-	Aluminium	theLeda D BL plus AL	1020706

Technical data

	theLeda D B AL	theLeda D B plus AL	theLeda D B plus S AL	theLeda D BL AL	theLeda D BL plus AL
Operating voltage	230 V AC				
Frequency	50–60 Hz				
Setting range brightness	2–800 lx			-	
LED output (lighting current)	760 lm				
Colour temperature	3000 K, warmwhite				
Service life	L80/B10/50,000 h				
Colour rendering index	CRI > 80				
Light switch-off delay	10 s–20 min			-	

Presence and motion detectors LED bollard light, with/without motion detector

	theLeda D B AL	theLeda D B plus AL	theLeda D B plus S AL	theLeda D BL AL	theLeda D BL plus AL
Ambient temperature	-25 °C ... +45 °C				
Protection class	II		I	II	
Type of protection	IP 55		IP 54	IP 55	

Detection area (semicircle)

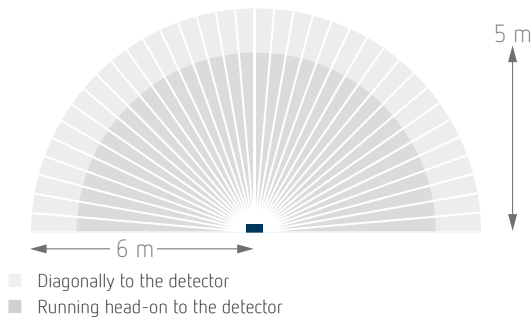

Connection example

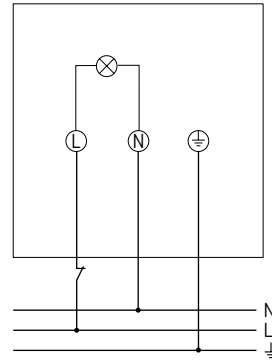

Scale drawings

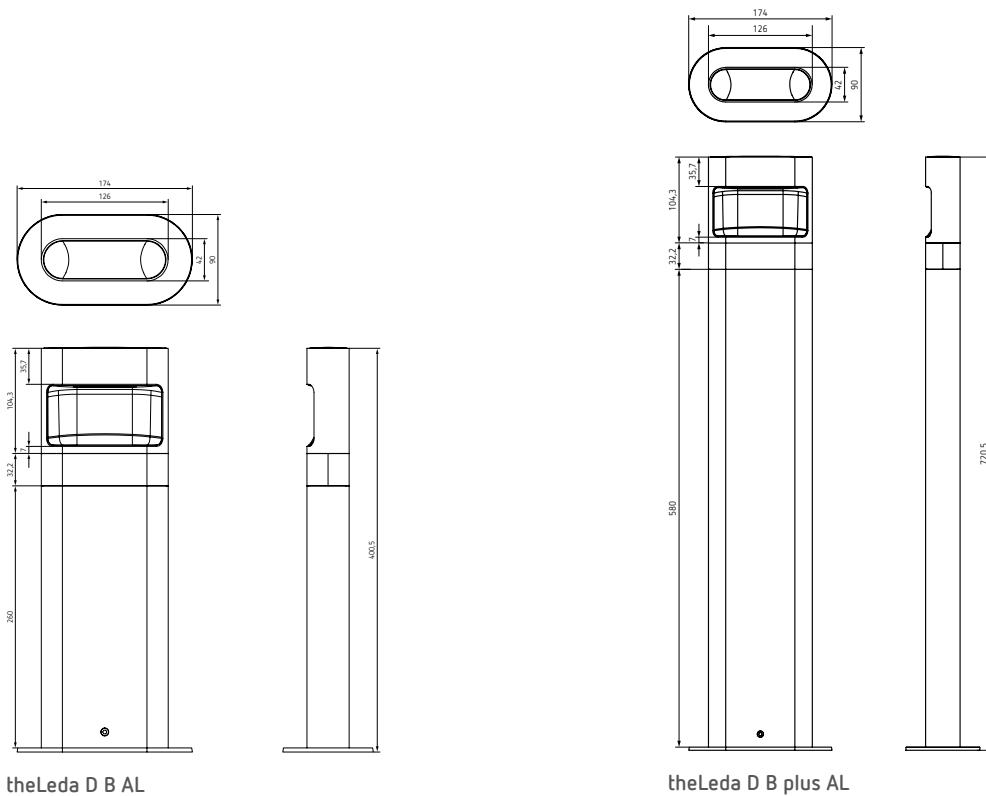

Accessories



theSenda B/P
↳ Art.No.: 9070985/9070910
Details page 359



theSenda S
↳ Art.No.: 9070911
Details page 359



theLeda D B ground spike
↳ Art.No.: 9070765
Details page 358

top3 is ready to move: out of the control cabinet and into the switch range itself



Now you can enjoy all the familiar benefits of the DIN rail-mounted devices from the top3 Performance range in a new flush-mounting version. The new top3 flush-mounted digital time switches fit in elegantly with different switch ranges while offering all the functionality of the top3 Performance range.

For more information, see page 256 onwards

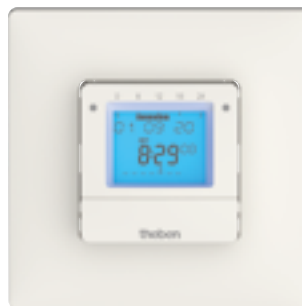

TR 030 top3 UP
(0300130)

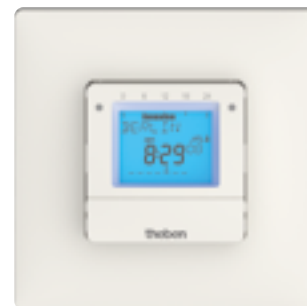

SELEKTA 070 top3 UP
(0700130)



Programming, whenever
and wherever you like
It couldn't be more flexible and convenient!

Create your programs directly on the top3 device, on a PC or laptop, or on a tablet or smartphone using the app – the choice is yours. The app is available for Android and iOS.



TIME AND LIGHT CONTROL

Digital time switches

Program	Number of channels	Memory locations	External inputs	PC Interface	Programmable by App	Type of connection	Type	Page
---------	--------------------	------------------	-----------------	--------------	---------------------	--------------------	------	------

DIN rail, 2 modules

	Weekly program	1	56	–	✓	✓	DuoFix spring terminals	TR 610 top3	244
		2	56	–	✓	✓	DuoFix spring terminals	TR 612 top3	244
		1	84	1	✓	✓	DuoFix spring terminals	TR 611 top3 TR 611 top3 RC	246 246
		2	84	2	✓	✓	DuoFix spring terminals	TR 622 top3	246
	Weekly program, astronomical program	1	56	–	✓	✓	DuoFix spring terminals	SELEKTA 170 top3	248
		2	56	–	✓	✓	DuoFix spring terminals	SELEKTA 174 top3	248
	2	84	2	✓	✓	DuoFix spring terminals	SELEKTA 172 top3	248	

DIN rail, 3 modules

	Yearly program, astronomical program	1	800	1	✓	–	DuoFix spring terminals	TR 641 top2 TR 641 top2 RC	250 250
		2	800	2	✓	–	DuoFix spring terminals	TR 642 top2 TR 642 top2 RC	250 250
		1	800	1	✓	–	DuoFix spring terminals	TR 641 top2 TR 641 top2 RC	250 250
		2	800	2	✓	–	DuoFix spring terminals	TR 642 top2 TR 642 top2 RC	250 250

DIN rail, 4 modules

	Yearly program, astronomical program	4	800	4	✓	–	DuoFix spring terminals	TR 644 top2 TR 644 top2 RC	250 250
		–	4	–	4	–	–	DuoFix spring terminals	EM 4 top2
	–	4	–	4	–	–	–	DuoFix spring terminals	EM 4 top2

DIN rail, 4 modules, LAN time switch

	Yearly program, astronomical program	4	800	–	–	–	Screw terminals	TC 649 E	253
---	--------------------------------------	---	-----	---	---	---	-----------------	----------	-----

DIN rail, 1 module

	Weekly program	1	56	–	✓	–	DuoFix spring terminals	TR 608 top2 S	254
			84	1	✓	–	DuoFix spring terminals	TR 609 top2 S	254
	Weekly program, astronomical program	1	56	1	✓	–	DuoFix spring terminals	SELEKTA 175 top2	254

Front panel installation/wall installation

	Weekly program	1	84	–	✓	–	Screw terminals	TR 635 top2	256
		2	84	–	✓	–	Screw terminals	TR 636 top2	256

Wall installation

	Weekly program	1	84	–	✓	✓	DuoFix spring terminals	TR 030 top3 UP	258
	Weekly program, astronomical program	1	84	–	✓	✓	DuoFix spring terminals	SELEKTA 070 top3 UP	258

Wall installation

	Weekly program	1	56	–	–	–	–	TR 684-1 top2	260
---	----------------	---	----	---	---	---	---	---------------	-----

Plug-in

	Weekly program	1	36	–	–	–	Plug-in	theben-eltimo 020 S	262
			33	–	–	–	Plug-in	theben-eltimo 020 S DCF	262

Time and light control

Digital time switches, DIN rail, 2 modules



TR 610 top3

TR 612 top3

TR 612 top2

Description

Common functions

- Digital time switch with weekly program
- DuoFix spring terminals
- Text-oriented user guidance in display
- 56 memory locations
- Interface for OBELISK top2 memory card (PC programming)
- 10 year power reserve (lithium battery)
- Zero-cross switching for relay-saving switching and high lamp loads (not with 24 V devices)
- ON-OFF switching times
- Switching preselection
- Permanent switching ON/OFF
- Integrated operating hour counter

- Holiday program
- Display back light (can be turned off)
- PIN coding
- Automatic summer/winter time changeover

TR 610 top3

- 1 channel
- Programming by app possible
- Safe transfer via optional Bluetooth Low Energy OBELISK top3
- Maximum manipulation security, time switch programs can only be transferred from the app to the time switch when the Bluetooth OBELISK top3 is plugged into the time switch
- 100 % compatible with top2

TR 612 top3

- 2 channels
- Programming by app possible
- Safe transfer via optional Bluetooth Low Energy OBELISK top3
- Maximum manipulation security, time switch programs can only be transferred from the app to the time switch when the Bluetooth OBELISK top3 is plugged into the time switch
- 100 % compatible with top2

TR 610 top2

- 1 channel

TR 612 top2

- 2 channels

Product selection

Program	Program functions	Number of channels	Switching load < 1 mA	Operating voltage	Type	Article number
Weekly program	ON-OFF	1	-	230 V AC	TR 610 top3	6100130
		2	-	230 V AC	TR 612 top3	6120130
		1	-	230-240 V AC	TR 610 top2	6100100
			✓	230-240 V AC	TR 610 top2 G	6100110
			-	12-24 V UC	TR 610 top2 24V	6104100
		2	-	230-240 V AC	TR 612 top2	6120100
-	12-24 V UC		TR 612 top2 24V	6124100		

Time and light control

Digital time switches, DIN rail, 2 modules

Technical data

	TR 610 top3	TR 612 top3	TR 610 top2 G	TR 610 top2 24V	TR 612 top2 24V
Operating voltage	230 V AC		230–240 V AC	12–24 V UC	12–24 V UC
Frequency	50–60 Hz				
Width	2 modules				
Installation type	DIN rail				
Type of contact	Changeover contact	Two-way changeover contact	Changeover contact		Two-way changeover contact
Power reserve	10 years				
Switching capacity at 250 V AC, $\cos \varphi = 1$	16 A				
Switching capacity at 250 V AC, $\cos \varphi = 0,6$	10 A		2 A		
Incandescent/halogen lamp load	2600 W		1400 W		
Energy saving lamps	1100 W		30 W		
LED lamp < 2 W (typ.)	50 W		6 W		
LED lamp > 2 W (typ.)	600 W		25 W		
Switching capacity min.	ca. 10 mA		< 1 mA	ca. 10 mA	
Shortest switching times	1 min				
Time accuracy at 25 °C	typical $\pm 0,25$ s/day (quartz)				
Stand-by consumption	0,4 W		0,8 W	0,3 W	
Type of protection	IP 20				
Protection class	II according to EN 60 730-1				
Ambient temperature	–30 °C ... +60 °C		–30 °C ... +55 °C		

18:00

Accessories

Front panel kit

Details page 352

Wall mounting kit 35 mm

Details page 352

Bluetooth OBELISK top3

Details page 353

Memory card OBELISK top2

Details page 353

PC set OBELISK top2/3

Details page 352

Connection diagrams

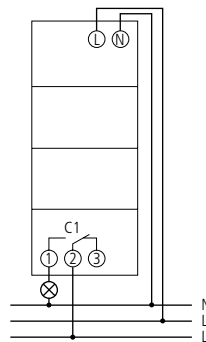

TR 610 top3, TR 610 top2

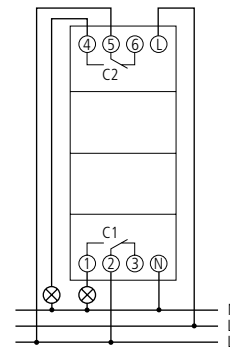

TR 612 top3, TR 612 top2

Time and light control

Digital time switches, DIN rail, 2 modules



TR 611 top3

TR 611 top3 RC

TR 622 top3

Description

Common functions

- Digital time switch with weekly program
- DuoFix spring terminals
- Text-oriented user guidance in display
- 84 memory locations
- Interface for OBELISK top2 memory card (PC programming)
- 10 year power reserve (lithium battery)
- Zero-cross switching for relay-saving switching and high lamp loads (not with 24 V devices)
- ON-OFF switching times
- Pulse program
- Cycle program
- Switching preselection
- Permanent switching ON/OFF
- Timer countdown
- Integrated operating hour counter
- Holiday program
- 2 random programs
- Display back light (can be turned off)
- PIN coding
- Automatic summer/winter time changeover

Functions top3 devices

- Programming by app possible
- Safe transfer via optional Bluetooth Low Energy OBELISK top3
- Maximum manipulation security, time switch programs can only be transferred from the app to the time switch when the Bluetooth OBELISK top3 is plugged into the time switch
- 100 % compatible with top2

TR 611 top3

- 1 channel, external input
- 3 special programs (small annual program)
- 84 memory locations

TR 611 top3 RC

- Time synchronisation option via connection of an external DCF or GPS antenna (GPS not with 24 V device)
- Additional power unit required for GPS if only one device is connected to the antenna
- 1 channel, external input
- 3 special programs (small annual program)
- 84 memory locations

TR 611 top3

- 2 channels, 2 external inputs
- 3 special programs (small annual program)
- 84 memory locations
- Channel switching and channel locking possible

TR 611 top2

- 1 channel
- External input
- 84 memory locations

TR 622 top2

- 2 channel
- 2 external inputs
- 84 memory locations

Produktauswahl

Program	Program functions	Number of channels	App programming	Time basis	Operating voltage	Type	Article number
Weekly program	ON-OFF, Pulse, Cycle	1	✓	Quarz	230 V AC	TR 611 top3	6110130
			-		12-24 V UC	TR 611 top2 24V	6114100
		2	✓	Quarz/ DCF77/GPS	110-230 V AC	TR 611 top3 RC	6110330
			-		12-24 V UC	TR 611 top2 RC 24V	6114300
		2	✓	Quarz	230 V AC	TR 622 top3	6220130
			-		12-24 V UC	TR 622 top2 24V	6224100

Technische Daten

	TR 611 top3	TR 611 top2 24V	TR 611 top3 RC	TR 611 top2 RC 24V	TR 622 top3	TR 622 top2 24V
Operating voltage	230 V AC	12–24 V UC	110–230 V AC	12–24 V UC	230 V AC	12–24 V UC
Frequency	50–60 Hz					
Width	2 TE					
Installation type	DIN-Schiene					
Type of contact	Wechsler					
Power reserve	10 Jahre					
Switching capacity at 250 V AC, cos φ = 1	16 A					
Switching capacity at 250 V AC, cos φ = 0,6	10 A	2 A	10 A	2 A	10 A	2 A
Incandescent/halogen lamp load	2600 W	1400 W	2600 W	1400 W	2600 W	1400 W
Energy saving lamps	1100 W	30 W	1100 W	30 W	1100 W	30 W
LED lamp < 2 W (typ.)	50 W	6 W	50 W	6 W	50 W	6 W
LED lamp > 2 W (typ.)	600 W	25 W	600 W	25 W	600 W	25 W
Switching capacity min.	ca. 10 mA					
Shortest switching times	1 s					
Time accuracy at 25 °C	typisch ± 0,25 s/Tag (Quarz)	typisch ± 0,25 s/Tag (Quarz) oder DCF77/ GPS			typisch ± 0,25 s/Tag (Quarz)	
Stand-by consumption	0,4 W	0,3 W	0,75 W	0,9 W	0,4 W	0,3 W
Type of protection	IP 20					
Protection class	II nach EN 60 730-1					
Ambient temperature	-30 °C ... +60 °C	-25 °C ... +55 °C			-30 °C ... +55 °C	-25 °C ... +55 °C

Accessories



PC set OBELISK top2/3
↳ Art.No.: 9070409
Details page 352



Memory card OBELISK top2
↳ Art.No.: 9070404
Details page 353



Bluetooth OBELISK top3
↳ Art.No.: 9070130
Details page 353

Front panel kit
Details page 352

Antenna RC-DCF
Details page 353

Antenna RC-GNSS
Details page 353

Antenna RC-GNSS R
Details page 353

Wall mounting kit
Details page 353

Connection diagrams

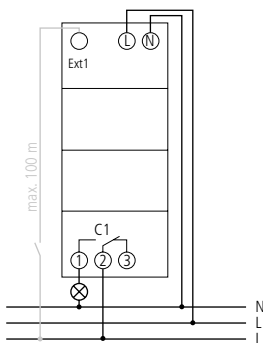

TR 611 top3

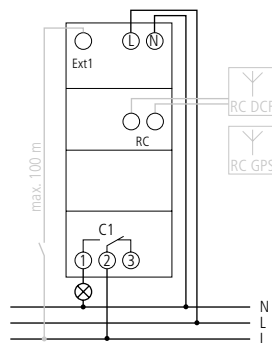

TR 611 top3 RC

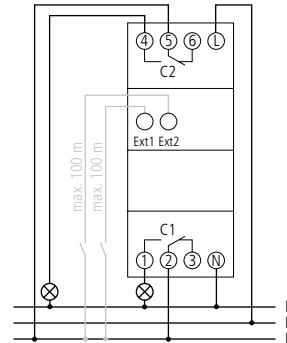

TR 622 top3

Time and light control

Digital time switches, DIN rail, 2 modules



SELEKTA 170 top3

SELEKTA 174 top3

SELEKTA 175 top2

Description

Common functions

- Astronomical time switch with weekly program
- Astronomical time switch function (automatic calculation of sunrise and sunset times for the whole year)
- DuoFix spring terminals
- Text-oriented user guidance in display
- Interface for OBELISK top2 memory card (PC programming)
- 10 year power reserve (lithium battery)
- Zero-cross switching for relay-saving switching and high lamp loads (not with 24 V devices)
- Calculated astronomical switching times
- Programmable ON-OFF switching times
- Switching preselection
- Permanent switching ON/OFF
- Integrated operating hour counter
- Holiday program
- Display back light (can be turned off)
- PIN coding
- Automatic summer/winter time changeover

Functions top3 devices

- Programming by app possible
- Safe transfer via optional Bluetooth Low Energy OBELISK top3
- Maximum manipulation security, time switch programs can only be transferred from the app to the time switch when the Bluetooth OBELISK top3 is plugged into the time switch
- 100 % compatible with top2

SELEKTA 170 top3

- 1 channel
- 56 memory locations

SELEKTA 174 top3

- As SELEKTA 170 top3, but:
- 2 channels

SELEKTA 171 top3 RC

- Time synchronisation via connection of external DCF or GPS antennas, additional positioning for astronomical program with GPS (GPS not with 24 V device)
- 1 channel, external input
- 3 special programs (small annual program)

- 3 custom twilight ranges plus adjustable offset (sunset, twilight, darkness)
- Astro-pulse, 84 memory locations

SELEKTA 172 top3

- 2 channels, 2 external inputs
- 3 special programs (small annual program)
- 3 custom twilight ranges plus adjustable offset (sunset, twilight, darkness)
- Astro-pulse, 84 memory locations
- Channel switching and channel locking possible

SELEKTA 172 top3 RC

- As SELEKTA 171 top3 RC, but:
- 2 channels, without external inputs

SELEKTA 170 top2

- 1 channel
- 56 memory locations

SELEKTA 175 top2

- 1 channel
- 56 memory locations
- External input

Product selection

Program	Number of channels	App programming	Time basis	Operating voltage	Type	Article number
Weekly program, astronomical program	1	✓	Quarz	230 V AC	SELEKTA 170 top3	1700130
	2	✓	Quarz	230 V AC	SELEKTA 174 top3	1740130
	1	-	Quarz	12-24 V UC	SELEKTA 170 top2 24V	1704100
		✓	Quarz/DCF77/GPS	110-230 V AC	SELEKTA 171 top3 RC	1710330
		-		12-24 V UC	SELEKTA 171 top2 RC 24V	1714100
	2	✓	Quarz	230 V AC	SELEKTA 172 top3	1720130
		-		12-24 V UC	SELEKTA 172 top2 24V	1724100
✓		Quarz/DCF77/GPS	110-230 V AC	SELEKTA 172 top3 RC	1710330	
1	-	Quarz	230-240 V AC	SELEKTA 175 top2	1750100	

Time and light control

Digital time switches, DIN rail, 2 modules

Technical data

	SELEKTA 170 top3	SELEKTA 174 top3	SELEKTA 170 top2 24V	SELEKTA 171 top3 RC	SELEKTA 172 top3 RC	SELEKTA 171 top2 RC 24V	SELEKTA 172 top3	SELEKTA 172 top2 24V	SELEKTA 175 top2
Operating voltage	230 V AC		12–24 V UC	110–230 V AC		12–24 V UC	230 V AC	12–24 V UC	230–240 V AC
Frequency	50–60 Hz								
Width	2 modules								1 module
Installation type	DIN rail								
Power reserve	10 years								
Switching capacity at 250 V AC, $\cos \phi = 1$	16 A								
Switching capacity at 250 V AC, $\cos \phi = 0,6$	10 A	2 A	10 A	2 A	10 A	2 A	10 A	2 A	4 A
Incandescent/halogen lamp load	2600 W	1400 W	2600 W	1400 W	2600 W	1400 W	2600 W	1400 W	2000 W
Energy saving lamps	1100 W	30 W	1100 W	30 W	1100 W	30 W	1100 W	30 W	300 W
LED lamp < 2 W (typ.)	50 W	6 W	50 W	6 W	50 W	6 W	50 W	6 W	55 W
LED lamp > 2 W (typ.)	600 W	20 W	600 W	20 W	600 W	20 W	600 W	20 W	180 W
Switching capacity min.	ca. 10 mA								
Shortest switching times	1 min								
Time accuracy at 25 °C	typical $\pm 0,25$ s/day (Quarz)			typical $\pm 0,25$ s/day (quartz) or DCF77/GPS			typical $\pm 0,25$ s/day (Quarz)		
Stand-by consumption	0,4 W	0,2 W	0,75 W	0,8 W	0,4 W	0,2 W	0,4 W	0,2 W	0,4 W
Type of protection	IP 20								
Protection class	II according to EN 60 730-1								
Ambient temperature	-30 °C ... +60 °C	-30 °C ... +55 °C	-25 °C ... +55 °C			-30 °C ... +55 °C	-25 °C ... +55 °C		

Accessories



PC set OBELISK top2/3
↳ Art.No.: 9070409
Details page 352



Memory card OBELISK top2
↳ Art.No.: 9070404
Details page 353



Bluetooth OBELISK top3
↳ Art.No.: 9070130
Details page 353

Front panel kit
Details page 352

Antenna RC-DCF
Details page 353

Antenna RC-GNSS R
Details page 353

Antenna RC-GNSS
Details page 353

Wall mounting kit
Details page 352

Connection diagrams

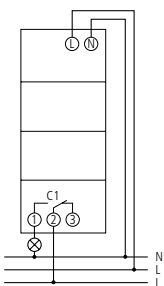

SELEKTA 170 top3

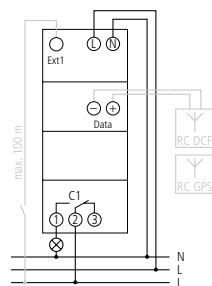

SELEKTA 171 top3 RC

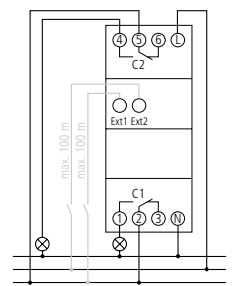

SELEKTA 172 top3

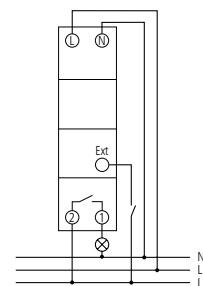

SELEKTA 175 top2

Time and light control

Digital time switches, DIN rail, 3 modules, 4 modules



TR 641 top2

TR 642 top2 RC

TR 644 top2

Description

Common functions

- Digital time switch with yearly and astronomical time program
- DuoFix spring terminals
- Text-oriented user guidance in display
- 800 memory locations
- Interface for OBELISK top2 memory card (PC programming)
- 8 year power reserve (lithium battery)
- Zero-cross switching for leay-saving switching and high lamp loads (not with 24 V devices)
- Automatic summer/winter time changeover
- ON-OFF switching times
- Pulse program
- Cycle program
- Extensive yearly clock functions
- Astronomical time switch function (automatic calculation of sunrise and sunset times for the whole year)
- Switching preselection

- Permanent switching ON/OFF
- Count-down timer
- Integrated operating hour counter
- Holiday program
- 2 random programs
- Display back light (can be turned off)
- PIN coding

TR 641 top2

- 1 channel
- External input

TR 641 top2 RC

- Time synchronisation via connection of external DCF or GPS antennas, additional positioning for astronomical program with GPS
- 1 channel
- External input
- Extension module can be connected
- Memory card OBELISK top2 included in delivery

TR 642 top2

- 2 channels
- 2 external inputs

TR 642 top2 RC

- As TR 641 top2 RC but:
- 2 channels
- 2 external inputs

TR 644 top2

- 4 channels
- 4 external inputs

TR 644 top2 RC

- As TR 641 top2 RC but:
- 4 channels
- 4 external inputs

Product selection

Program	Number of channels	External inputs	Time basis	Memory card supplied	Program functions	Operating voltage	Type	Article number
Yearly program, astronomical program	1	1	Quartz	-	ON-OFF, Pulse, Cycle	110–240 V AC	TR 641 top2	6410100
			Quartz/DCF77/GPS	✓	ON-OFF, Pulse, Cycle	110–240 V AC	TR 641 top2 RC	6410300
	2	2	Quartz	-	ON-OFF, Pulse, Cycle	110–240 V AC	TR 641 top2 RC 24V	6414300
			Quartz	-	ON-OFF, Pulse, Cycle	12–24 V UC	TR 641 top2 RC 24V	6414300
			Quartz	-	ON-OFF, Pulse, Cycle	110–240 V AC	TR 642 top2	6420100
			Quartz/DCF77/GPS	✓	ON-OFF, Pulse, Cycle	110–240 V AC	TR 642 top2 RC	6420300
4	4	Quartz	-	ON-OFF, Pulse, Cycle	110–240 V AC	TR 642 top2 RC 24V	6424300	
		Quartz	-	ON-OFF, Pulse, Cycle	12–24 V UC	TR 642 top2 RC 24V	6424300	
4	4	Quartz	-	ON-OFF, Pulse, Cycle	110–240 V AC	TR 644 top2	6440100	
		Quartz/DCF77/GPS	✓	ON-OFF, Pulse, Cycle	110–240 V AC	TR 644 top2 RC	6440300	

Time and light control

Digital time switches, DIN rail, 3 modules, 4 modules

Technical data

	TR 641 top2	TR 642 top2	TR 641 top2 RC	TR 642 top2 RC	TR 644 top2	TR 644 top2 RC	TR 641 top2 RC 24V	TR 642 top2 RC 24V
Operating voltage	110–240 V AC						12–24 V UC	
Frequency	50–60 Hz							
Width	3 modules				4 modules		3 modules	
Installation type	DIN rail							
Power reserve	8 years							
Switching capacity at 250 V AC, $\cos \varphi = 1$	16 A				2 x 16 A 2 x 10 A		16 A	
Switching capacity at 250 V AC, $\cos \varphi = 0,6$	10 A						2 A	
Incandescent/halogen lamp load 230 V	2600 W				2300 W		1400 W	
Incandescent/halogen lamp load 120 V	1300 W				1150 W		–	
Energy saving lamps 230 V	37 x 7 W, 30 x 11 W, 26 x 15 W, 26 x 20 W, 11 x 23 W						7 x 7 W, 6 x 11 W, 5 x 15 W, 5 x 20 W, 4 x 23 W	
Energy saving lamps 120 V	18 x 7 W, 15 x 11 W, 13 x 15 W, 13 x 20 W, 11 x 23 W						–	
LED lamp < 2 W (typ.)	50 W						–	
LED lamp > 2 W (typ.)	200 W						–	
Switching capacity min.	Approx. 10 mA							
Shortest switching time	1 s							
Time accuracy at 25 °C	$\leq \pm 0,5$ s/day (quartz)		$\leq \pm 0,5$ s/day (quartz) or DCF77/GPS		$\leq \pm 0,5$ s/day (quartz)	$\leq \pm 0,5$ s/day (quartz) or DCF77/GPS		
Stand-by consumption	0,6 W	0,6 W	1,2 W	1,2 W	0,5 W	1,3 W	1,5 W	
Type of protection	IP 20							
Protection class	II according to EN 60 730-1							
Ambient temperature	–30 °C ... +45 °C							



Accessories



EM 4 top2
for TR RC
↳ Art.No.: 6490104
Details page 252



Antenna RC-DCF
for TR RC
↳ Art.No.: 9070410
Details page 353

Wall mounting kits

Details page 352

Front panel kit

Details page 352

Antenna RC-GNSS

Details page 353

Antenna RC-GNSS R

Details page 353

Memory card OBELISK top2

Details page 353

PC set OBELISK top2/3

Details page 352

Connection diagrams

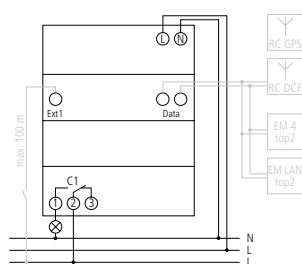

TR 641 top2 RC

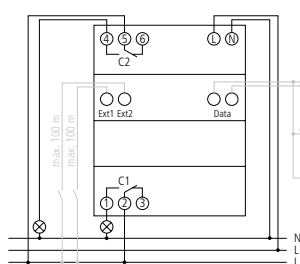

TR 642 top2 RC

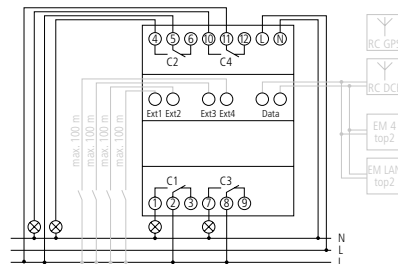

TR 644 top2 RC

Time and light control

Digital time switches, DIN rail, 4 modules



EM 4 top2

Description

- Extension module for TR 641 top2 RC, TR 642 top2 RC and TR 644 top2 RC
- 4 channels
- Width: 4 modules
- DuoFix spring terminals
- 4 external inputs
- Switching preselection
- Permanent ON/OFF switching
- 4 LEDs for displaying switching status
- Zero-cross switching for relay-saving switching and high lamp loads

Product selection

Type	Article number
EM 4 top2	6490104

Technical data

	EM 4 top2
Operating voltage	110–240 V AC
Frequency	50–60 Hz
Width	4 modules
Installation type	DIN rail
Type of contact	Two-way switch
Switching capacity at 250 V AC, $\cos \varphi = 1$	16 A
Switching capacity channels 1+3	10 A
Switching capacity at 250 V AC, $\cos \varphi = 0,6$	10 A
Incandescent/halogen lamp load 230 V	2300 W
Incandescent/halogen lamp load 120 V	1150 W
Energy saving lamps 230 V	22 x 7 W, 18 x 11 W
Energy saving lamps 120 V	11 x 7 W, 9 x 11 W
Switching capacity min.	ca. 10 mA
Stand-by consumption	1,5 W
Type of protection	IP 20
Protection class	II according to EN 60 730-1
Ambient temperature	-30 °C ... +55 °C

Accessories

Front panel kit

Details page 352

Wall mounting kit 70 mm

Details page 352

Connection diagram

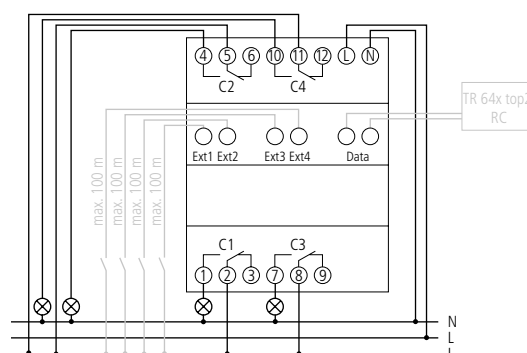



TC 649 E

Description

- Digital time switch / astro time switch with weekly program and annual program
- With integrated webserver, can be controlled via LAN / smartphone
- 4 channels
- 800 memory programs
- Channel 1 to 4 can be switched over as time or astro time switch program
- 3 special programs per channel: switching program / astro program; Duration Off; Duration Each with year date function
- Local holidays, fixed date ranges, recurring date ranges and Easter-themed holidays
- Astro times with other night interruption / fixed ON circuit
- Permanent ON or OFF switching via LAN switchable
- Pulse program
- Automatic summer winter time changeover Europe; Canada; UNITED STATES; Iran, Australia and freely definable
- Deactivate summer / winter time change over
- Hour counter

Product selection

Type	Article number
TC 649 E	6490130

Technical data

	TC 649 E
Operating voltage	230 V AC
Frequency	50 – 60 Hz
Width	4 modules
Installation type	DIN rail
Switching capacity at 250 V AC, $\cos \phi = 1$	6 A
Stand-by consumption	3 W
Type of protection	IP 30
Protection class	II according to EN 60 730-1
Ambient temperature	-25 °C ... +55 °C

Connection diagram

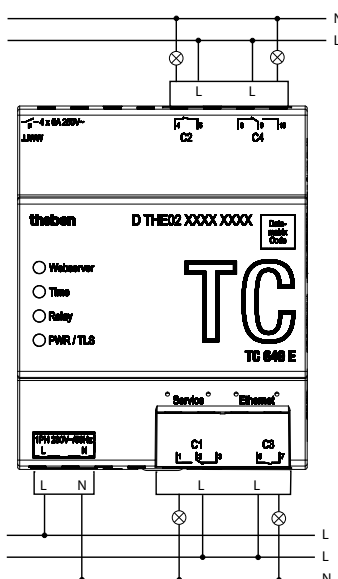

Time and light control

Digital time switches, DIN rail, 1 module



TR 608 top2 S

TR 609 top2 S

SELEKTA 175 top2

Description

Common functions

- 1 channel
- DuoFix spring terminals
- Text-oriented user guidance in display
- Interface for OBELISK top2 memory card (PC programming)
- 10 year power reserve (lithium battery)
- Switching preselection
- Integrated operating hour counter
- Holiday program
- PIN coding
- Automatic summer/winter time changeover

TR 608 top2 S

- Digital time switch with weekly program
- 56 memory locations
- ON-OFF switching times
- Permanent switching ON/OFF

TR 609 top2 S

- Digital time switch with weekly program
- 84 memory locations
- External input
- Pulse program
- Cycle program
- Timer countdown
- 2 random programs
- ON-OFF switching times
- Permanent switching ON/OFF

SELEKTA 175 top2

- Astronomical time switch with weekly program
- External input
- 56 memory locations
- Astronomical time switch function (automatic calculation of sunrise and sunset times for the whole year)
- Offset for adjusting of sunrise and sunset times
- Calculated astronomical switching times
- Fixed ON-OFF switching times can be programmed (e.g. night time interruption)
- Permanent switching ON/OFF

Product selection

Program	Number of channels	Memory locations	Program functions	Operating voltage	Type	Article number
Weekly program	1	56	-	230–240 V AC	TR 608 top2 S	6080101
		84	-	230–240 V AC	TR 609 top2 S	6090101
Weekly program, astronomical program	1	1	Quartz	230–240 V AC	SELEKTA 175 top2	1750100

Technical data

	TR 608 top2 S	TR 609 top2 S	SELEKTA 175 top2
Operating voltage	230–240 V AC		
Frequency	50–60 Hz		
Width	1 module		
Installation type	DIN rail		
Type of contact	Changeover contact	NO contact	
Power reserve	10 years		
Switching capacity at 250 V AC, $\cos \phi = 1$	16 A		
Switching capacity at 250 V AC, $\cos \phi = 0,6$	4 A		
Incandescent/halogen lamp load 230 V	1000 W	2000 W	
Energy saving lamps 230 V	30 W	300 W	
LED lamp < 2 W (typ.)	6 W	55 W	
LED lamp > 2 W (typ.)	60 W	600 W	
Switching capacity min.	10 mA		
Shortest switching times	1 min		
Time accuracy at 25 °C	typical $\pm 0,25$ s/day (quartz)		
Stand-by consumption	0,4 W		
Type of protection	IP 20		
Protection class	II according to EN 60 730-1		
Ambient temperature	–25 °C ... +55 °C		

18:00

Accessories

Front panel kit

Details page 352

Wall mounting kit 17,5 mm

Details page 352

Memory card OBELISK top2

Details page 353

PC set OBELISK top2/3

Details page 352

Connection diagrams

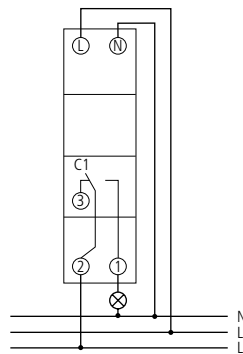

TR 608 top2 S

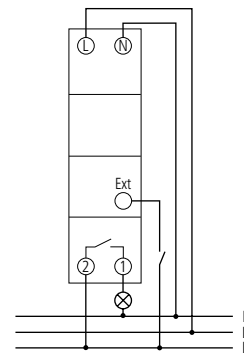

TR 609 top2 S, SELEKTA 175 top2

Time and light control

Digital time switches, Front panel installation/wall installation



TR 635 top2

TR 636 top2

Description

Common functions

- Digital time switch with weekly program
- Text-based operator guidance in the display
- 84 memory locations
- Interface for OBELISK top2 memory card (PC programming)
- 10 year power reserve (lithium battery)
- ON-OFF switching times
- Pulse program
- Cycle program

- Switching preselection
- Permanent ON/OFF switching
- Count-down timer
- Integrated hour counter
- Holiday program
- 2 random programs
- Back lighting (can be turned off)
- PIN coding
- Automatic summer/winter time changeover

TR 635 top2

- 1 channel

TR 636 top2

- 2 channels

Product selection

Program	Number of channels	Memory locations	Program functions	Operating voltage	Type	Article number
Weekly program	1	84	ON-OFF, Pulse, Cycle	230–240 V AC	TR 635 top2	6350100
	2	84	ON-OFF, Pulse, Cycle	230–240 V AC	TR 636 top2	6360100

Time and light control

Digital time switches, Front panel installation/wall installation

Technical data

	TR 635 top2	TR 636 top2
Operating voltage	230–240 V AC	
Frequency	50–60 Hz	
Installation type	Front panel installation/wall installation	
Type of contact	Changeover contact	
Power reserve	10 years	
Switching capacity at 250 V AC, $\cos \varphi = 1$	16 A	6 A
Switching capacity at 250 V AC, $\cos \varphi = 0,6$	10 A	6 A
Incandescent/halogen lamp load	2300 W	1200 W
Energy saving lamps 230 V	90 W	
LED lamp < 2 W (typ.)	20 W	
LED lamp > 2 W (typ.)	50 W	
Shortest switching times	1 s	
Time accuracy at 25 °C	$\leq \pm 0.5$ s/day (quartz) at 25 °C	
Stand-by consumption	0,9 W	1,1 W
Type of protection	IP 20	
Protection class	II according to EN 60 730-1	
Ambient temperature	–30 °C ... +55 °C	

Accessories



PC set OBELISK top2/3

↳ Art.No.: 9070409
Details page 352



Memory card OBELISK top2

↳ Art.No.: 9070404
Details page 353



Snap-on mounting 72 x 72

↳ Art.No.: 9070071
Details page 352

Scale drawings

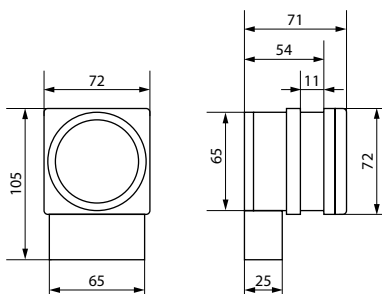

TR 635 top2, TR 636 top2

Connection diagrams

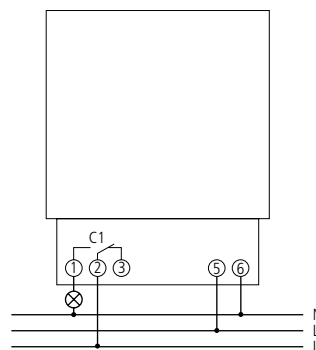

TR 635 top2

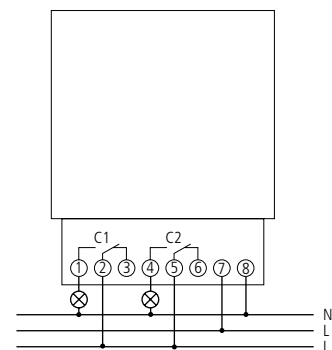

TR 636 top2

Time and light control

Digital time switches, Wall installation



TR 030 top3 UP

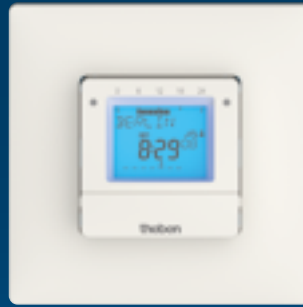

SELEKTA 070 top3 UP

Description

Common functions

- Digital time switch with weekly program for flush-mounted wall mounting
- 1 channel
- Programming by app possible
- Safe transfer via optional Bluetooth Low Energy OBELISK top3
- Maximum manipulation security, time switch programs can only be transferred from the app to the time switch when the Bluetooth OBELISK top3 is plugged into the time switch
- 3 special programs (small annual program)
- 84 memory locations
- DuoFix spring terminals
- Text-oriented user guidance in display
- 6 year power reserve

- Interface for OBELISK top2 memory card (PC programming)
- Switching preselection
- Permanent switching ON/OFF
- Integrated operating hour counter
- Holiday program
- PIN coding
- Automatic summer / winter time changeover
- Adapter frames for common switch ranges available as accessory

TR 030 top3 UP

- Digital time switch with weekly program
- Pulse program
- Cycle program
- Random program

SELEKTA 070 top3 UP

- Astronomical time switch with weekly program
- Astronomical time switch function (automatic calculation of sunrise and sunset times for the whole year)
- Offset to adjust sunrise and sunset times
- 3 custom twilight ranges plus adjustable offset (sunset, twilight, darkness)
- Astro-pulse
- Programmable ON-OFF switching times, for example for night interruption

Product selection

Program	Number of channels	Memory locations	Program functions	Operating voltage	Type	Article number
Weekly program	1	84	ON-OFF, Pulse, Cycle	230 V AC	TR 030 top3 UP	0300130
Weekly program, Astro program	1	84	ON-OFF, Pulse	230 V AC	SELEKTA 070 top3 UP	0700130

Technical data

	TR 030 top3 UP/SELEKTA 070 top3 UP
Operating voltage	230 V AC
Frequency	50 Hz
Type of contact	NO contact
Power reserve	6 years
Switching capacity at 250 V AC, $\cos \varphi = 1$	10 A
Switching capacity at 250 V AC, $\cos \varphi = 0,6$	2 A
Incandescent/halogen lamp load 230 V	2300 W
LED lamp < 2 W (typ.)	50 W
LED lamp < 2 W (typ.)	600 W
Switching capacity min.	10 mA
Shortest switching times	1 s
Time accuracy at 25 °C	typical $\pm 0,25$ s/day (quartz)
Stand-by consumption	0,4 W
Type of protection	IP 20
Protection class	II according to EN 60 730-1
Ambient temperature	-5 °C ... +55 °C

18:00

Accessories



Bluetooth OBELISK top3

↳ Art.No.: 9070130

Details page 353



PC set OBELISK top2/3

↳ Art.No.: 9070409

Details page 352



Memory card OBELISK top2

↳ Art.No.: 9070404

Details page 353

Scale drawings

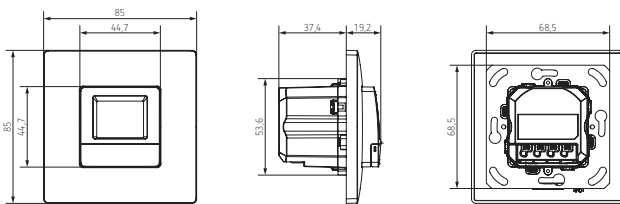

Connection diagram

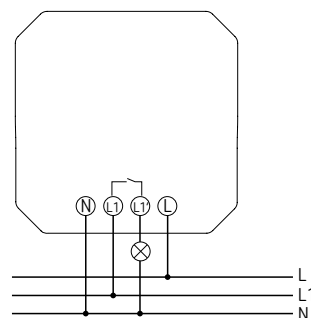

Time and light control

Digital time switches, Front panel installation/wall installation



TR 684-1 top2

Description

Common functions

- Digital time switch with weekly program
- 1 channel
- Timer module without plug-in base
- Connection by 4.8 mm AMP flat plug for original installation standard devices
- For installation in regulation and control

- Text-based operator guidance in the display
- 56 memory locations
- Interface for OBELISK top2 memory card (PC programming)
- 10 year power reserve (lithium battery)
- ON-OFF switching times
- Switching preselection

- Permanent ON/OFF switching
- Integrated hour counter
- Holiday program
- Back lighting (can be turned off)
- PIN coding
- Automatic summer/winter time changeover

Product selection

Program	Number of channels	Memory locations	Program functions	Operating voltage	Type	Article number
Weekly program	1	56	ON-OFF	230–240 V AC	TR 684-1 top2	6840100

Technical data

	TR 684-1 top2
Operating voltage	230–240 V AC
Frequency	50–60 Hz
Installation type	Front panel installation/wall installation
Type of contact	Changeover contact
Power reserve	10 years
Switching capacity at 250 V AC, cos φ = 1	6 A
Switching capacity at 250 V AC, cos φ = 0,6	1 A
Shortest switching times	1 min
Time accuracy at 25 °C	≤ ± 0.5 s/day (quartz) at 25 °C
Stand-by consumption	1 W
Type of protection	IP 20
Protection class	II according to EN 60 730-1
Ambient temperature	– 10 °C ... +55 °C

Accessories



PC set OBELISK top2/3

↳ Art.No.: 9070409

Details page 352



Memory card OBELISK top2

↳ Art.No.: 9070404

Details page 353

Scale drawings

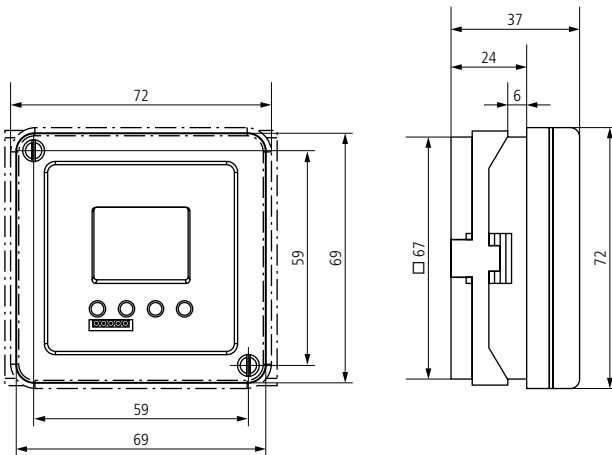

Connection diagrams

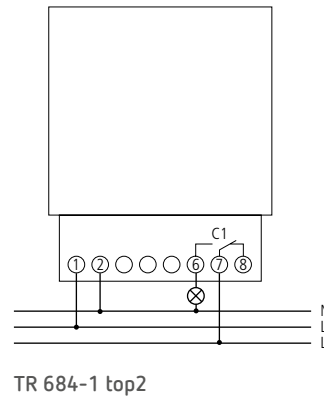

18:00

Time and light control

Digital time switches, Plug-in



theben-eltimo 020 S

theben-eltimo 020 S DCF

Description

Common functions

- Digital plug-in timer with weekly program
- Use with earthed sockets
- 1 channel
- Easy operation via keys for program function and day of the week, hours, minutes

- ON-OFF switching times
- Switching preselection
- Permanent switching ON/OFF
- Random program
- Automatic summer/winter time changeover

theben-eltimo 020 S

- 36 memory locations

theben-eltimo 020 S DCF

- DCF radio control
- 33 memory locations

Product selection

Program	Number of channels	Memory locations	Time basis	Operating voltage	Type	Article number
Weekly program	1	36	Quartz	230 V AC	theben-eltimo 020 S	0200000
		33	Quartz/DCF77	230 V AC	theben-eltimo 020 S DCF	0200300

Technical data

	theben-eltimo 020 S	theben-eltimo 020 S DCF
Operating voltage	230 V AC	
Frequency	50 Hz	
Installation type	Plug-in	
Type of contact	NO contact	
Power reserve	20 days	
Switching capacity at 250 V AC, $\cos \varphi = 1$	16 A	
Switching capacity at 250 V AC, $\cos \varphi = 0,6$	2 A	
Incandescent/halogen lamp load 230 V	1000 W	
Shortest switching times	1 min	
Time accuracy at 25 °C	$\leq \pm 1$ s/day (quartz)	DCF77 synchronous or $\leq \pm 1$ s/day (quartz)
Stand-by consumption	0,8 W	
Type of protection	IP 20	
Protection class	II for housing, I for plug system as per EN 62 730-1	
Ambient temperature	-10 °C ... +40 °C	

Scale drawings

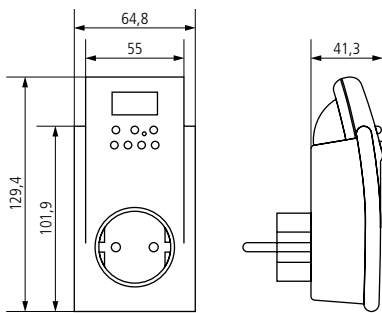

theben-eltimo 020 S, theben-eltimo 020 S DCF

18:00

theben-timer 26

It just keeps on running

There is one product that captures the development and success of our company better than almost any other: the theben-timer 26. This analogue plug-in time switch was launched in 1977, bringing automatic timers into more than 30 million homes. It is an early example of energy awareness that appeared well before the word sustainability was on anyone's lips – and certainly before any of the associated implications came into play.

For more information, see page 279



More than
30 million
units have
been sold
and are
helping to
achieve
energy
savings.

TIME AND LIGHT CONTROL

Analogue time switches

	Program	Number of channels	Type of contact	Power reserve	Shortest switching times	Programmable every	Type of connection	Type	Page
--	---------	--------------------	-----------------	---------------	--------------------------	--------------------	--------------------	------	------



DIN rail, 1 module

	Daily program	1	NO contact	–	15 min	15 min	Screw terminals	SYN 160 a	266
				3 days	15 min	15 min	Screw terminals	SUL 180 a	266
	Weekly program	1	NO contact	3 days	2 h	2 h	Screw terminals	MEM 190 a	266

DIN rail, 3 modules

	60 minutes program	1	Changeover contact	–	37,5 s	37,5 s	DuoFix spring terminals	SYN 151 h	268
	Daily program	1	Changeover contact	–	15 min	15 min	DuoFix spring terminals	SYN 161 d	268
				200 hours	15 min	15 min	DuoFix spring terminals	SUL 181 d	268
	Weekly program	1	Changeover contact	200 hours	2 h	2 h	DuoFix spring terminals	SUL 191 w	268
	Daily program	2	Changeover contact	3 days	30 min	15 min	Screw terminals	SUL 188 g	270
	Daily/weekly program with 1/2 day OFF function	1	Changeover contact	3 days	45 min, 12 h	15 min, 12 h	Screw terminals	SUL 188 hw	270

Front panel installation/wall installation

	Daily program	1	Changeover contact	–	15 min	15 min	Screw terminals	SYN 169 s	272
				3 days	15 min	15 min	Screw terminals	SUL 189 s	272
	Daily program	1	Changeover contact	–	20 min, 2 h	5 min, 30 min	Screw terminals	SYN 269 h	274
				3 days	20 min, 2 h	5 min, 30 min	Screw terminals	SUL 289 h	274
			2	Changeover contact	3 days	20 min, 2 h	5 min, 30 min	Screw terminals	SUL 289 g
	60 minutes program	1	Changeover contact	–	1,25 min	18,5 s	Screw terminals	TM 179 h	276
	Daily/weekly program with 1/2 day OFF function	1	Changeover contact	3 days	30 min, 12 h	15 min, 12 h	Screw terminals	SUL 189 hw	276

Wall installation/3-point mounting

	Daily program	2	Changeover contact	6 days	20 min	5 min	Screw terminals	SUL 285/2 T	278
---	---------------	---	--------------------	--------	--------	-------	-----------------	-------------	-----

Plug-in

	Daily program	1	NO contact	–	15 min	15 min	Plug-in	theben-timer 26	279
								theben-timer 26 IP 44	279
		Weekly program	1	NO contact	–	2 h	2 h	Plug-in	theben-timer 27

Surface-mounted

	Daily and defrost program	2	Changeover contact	–	2 min, 1 h	1 min, 1 h	Screw terminals	FRI 77 g	280
---	---------------------------	---	--------------------	---	------------	------------	-----------------	----------	-----

Drive with quick fastening for DIN rail

	Daily and defrost program	1	Changeover contact	–	2 min, 1 h	1 min, 1 h	Screw terminals	FRI 77 h-2	280
		2	Changeover contact	–	2 min, 1 h	1 min, 1 h	Screw terminals	FRI 77 g-2	280

Time and light control

Analogue time switches, DIN rail, 1 module



Description

Common functions

- Analogue time switch
- 1 channel
- Screw terminals
- Manual switch with 3 positions: Permanent ON/AUTO/continuous OFF

SYN 160 a

- Daily program
- Without power reserve
- 96 switching segments
- Synchronised with mains
- Shortest switching time: 15 minutes

SUL 180 a

- Daily program
- With power reserve
- 96 switching segments
- Quartz controlled
- Shortest switching time: 15 minutes

MEM 190 a

- Weekly program
- With power reserve
- 84 switching segments
- Quartz controlled
- Shortest switching time: 2 hours

Product selection

Program	Number of channels	Power reserve	Shortest switching times	Programmable every	Type of contact	Operating voltage	Type	Article number
Daily program	1	-	15 min	15 min	NO contact	230 V AC	SYN 160 a	1600001
		3 days	15 min	15 min	NO contact	230–240 V AC	SUL 180 a	1800001
Weekly program	1	3 days	2 h	2 h	NO contact	230–240 V AC	MEM 190 a	1900001

Time and light control

Analogue time switches, DIN rail, 1 module

Technical data

	SYN 160 a	SUL 180 a	MEM 190 a
Operating voltage	230 V AC	230–240 V AC	
Frequency	50 Hz	50–60 Hz	
Width	1 module		
Installation type	DIN rail		
Program	Daily program		Weekly program
Power reserve	–	3 days	
Switching capacity at 250 V AC, $\cos \varphi = 1$	16 A		
Switching capacity at 250 V AC, $\cos \varphi = 0,6$	4 A		
Incandescent/halogen lamp load	1000 W		
Energy saving lamps	150 W		
LED lamp < 2 W (typ.)	30 W		
LED lamp 2–8 W (typ.)	90 W		
LED lamp > 8 W (typ.)	300 W		
Shortest switching times	15 min		2 h
Programmable every	15 min		2 h
Time accuracy at 25 °C	Synchronised with mains	$\leq \pm 1$ s/day (quartz)	
Stand-by consumption	0,9 W	0,5 W	
Test approval	VDE		
Type of protection	IP 20		
Protection class	II according to EN 60 730-1		
Ambient temperature	–25 °C ... +50 °C	–10 °C ... +50 °C	

Accessories



Front panel kit
↳ Art.No.: 9070001
Details page 352



Wall mounting kit 17,5 mm
↳ Art.No.: 9070065
Details page 352

Connection diagrams

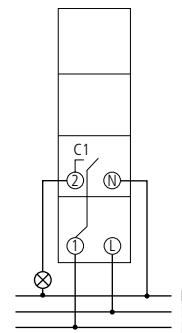

SYN 160 a, SUL 180 a, MEM 190 a

Time and light control

Analogue time switches, DIN rail, 3 modules



SYN 151 h

SUL 181 d

SUL 191 w

Description

Common functions

- Analogue time switch
- 1 channel
- DuoFix spring terminals
- Switching preselection
- Manual switch with 3 positions: Continuous ON/AUTO/continuous OFF
- Switching status display

SYN 151 h

- 60 minute program
- Without power reserve
- 96 switching segments
- Synchronised with mains
- Shortest switching time: 37.5 seconds

SYN 161 d

- Daily program
- Without power reserve
- 96 switching segments
- Synchronised with mains
- Shortest switching time: 15 minutes
- Clock hands for time display and in addition 12/24 hour recognition
- Simple summer/winter time correction

SUL 181 d

- Daily program
- With power reserve
- 96 switching segments
- Quartz controlled
- Shortest switching time: 15 minutes
- Clock hands for time display and in addition 12/24 hour recognition
- Simple summer/winter time correction

SUL 191 w

- Weekly program
- With power reserve
- 84 switching segments
- Quartz controlled
- Shortest switching time: 2 hours
- Clock hands for time display and in addition 12/24 hour recognition
- Simple summer/winter time correction

Product selection

Program	Number of channels	Power reserve	Shortest switching time	Programmable every	Type of contact	Operating voltage	Type	Article number	
60 minutes program	1	-	37,5 s	37,5 s	Changeover contact	230 V AC	SYN 151 h	1510011	
Daily program	1	-	15 min	15 min	Changeover contact	230 V AC	SYN 161 d	1610011	
			200 h	15 min	15 min	Changeover contact	110-230 V AC	SUL 181 d	1810011
							12-24 V UC	SUL 181 d 24V	1814011
Weekly program	1	200 h	2 h	2 h	Changeover contact	110-230 V AC	SUL 191 w	1910011	

Time and light control

Analogue time switches, DIN rail, 3 modules

Technical data

	SYN 151 h	SYN 161 d	SUL 181 d	SUL 191 w	SUL 181 d 24V
Operating voltage	230 V AC		110–230 V AC		12–24 V UC
Frequency	50 Hz		50–60 Hz		
Width	3 modules				
Installation type	DIN rail				
Program	60 minutes program	Daily program		Weekly program	Daily program
Power reserve	–		100 hours, approx. 50 hours at 110 V		100 hours
Switching capacity at 250 V AC, $\cos \varphi = 1$	10 A	16 A			
Switching capacity at 250 V AC, $\cos \varphi = 0,6$	4 A				
Incandescent/halogen lamp load	1100 W				
LED lamp < 2 W (typ.)	20 W				
LED lamp > 2 W (typ.)	180 W				
Shortest switching time	37,5 s	15 min		2 h	15 min
Programmable every	37,5 s	15 min		2 h	15 min
Time accuracy at 25 °C	Synchronised with mains		$\leq \pm 1 \text{ s/day}$ (quartz)		
Stand-by consumption	0,9 W	0,5 W			
Test approval	VDE				–
Type of protection	IP 20				
Protection class	II according to EN 60 730-1				
Ambient temperature	–20 °C ... +55 °C				

Accessories



Wall mounting kit 52,5 mm
 ↳ Art.No.: 9070050
 Details page 352



Front panel kit
 ↳ Art.No.: 9070001
 Details page 352

Connection diagrams

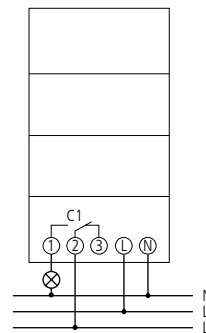

SYN 151 h, SYN 161 d,
 SUL 181 d, SUL 191 w

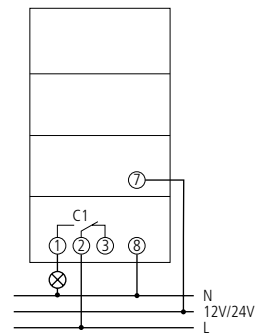

SUL 181 d 24V

Time and light control

Analogue time switches, DIN rail, 3 modules



SUL 188 g

SUL 188 hw

Description

Common functions

- Analogue time switch
- With power reserve
- Quartz controlled
- Tappets
- Screw terminals
- Switching status display
- Operating indication

SUL 188 g

- Daily program
- 2 channels
- Fine adjustment to set the time to the minute
- Shortest switching time: 30 minutes
- 10 tappets included in delivery

SUL 188 hw

- Daily/weekly program and 1/2 day OFF function for the weekdays
- 1 channel (with series connection of the 2 contacts)
- Tappets and turning segments
- Shortest switching time: 45 minutes (12 hours for the 1/2 day OFF function)
- 6 tappets included in delivery

Product selection

Program	Number of channels	Power reserve	Shortest switching times	Programmable every	Type of contact	Operating voltage	Type	Article number
Daily program	2	3 days	30 min	15 min	Changeover contact	230 V AC	SUL 188 g	1880033
Daily/weekly program with 1/2 day OFF function	1	3 days	45 min, 12 h	15 min, 12 h	Changeover contact	230 V AC	SUL 188 hw	1880108

Time and light control

Analogue time switches, DIN rail, 3 modules

Technical data

	SUL 188 g	SUL 188 hw
Operating voltage	230 V AC	
Frequency	45–60 Hz	
Width	3 modules	
Installation type	DIN rail	
Program	Daily program	Daily/weekly program with 1/2 day OFF function
Power reserve	3 days	
Switching capacity at 250 V AC, $\cos \varphi = 1$	10 A	
Switching capacity at 250 V AC, $\cos \varphi = 0,6$	4 A	
Shortest switching times	30 min	45 min, 12 h
Programmable every	15 min	15 min, 12 h
Time accuracy at 25 °C	$\leq \pm 1 \text{ s/day}$ (quartz)	
Stand-by consumption	0,5 W	
Test approval	VDE	
Type of protection	IP 20	
Protection class	II according to EN 60 730-1	
Ambient temperature	-20 °C ... +55 °C	

Accessories



Front panel kit

↳ Art.No.: 9070001
Details page 352



Terminal cover 52,5 mm

↳ Art.No.: 9070061
Details page 352

Connection diagrams

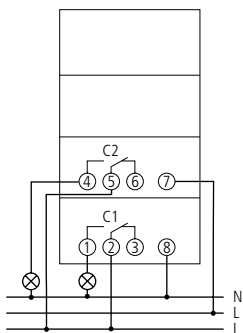

SUL 188 g

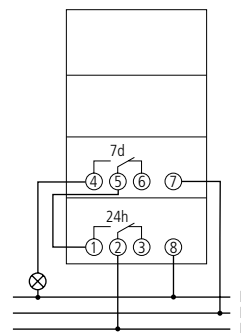

SUL 188 hw

Time and light control

Analogue time switches, Front panel installation / wall installation



SYN 169 s

SUL 189 s

Description

Common functions

- Analogue time switch
- 1 channel
- Daily program
- 96 switching segments
- Shortest switching time: 15 minutes
- Clock hands for time display
- Switching preselection
- Permanent ON/OFF switch
- Switching status display
- Simple summer / winter time correction

SYN 169 s

- Without power reserve
- Synchronised with mains

SUL 189 s

- With power reserve
- Quartz controlled

Product selection

Program	Number of channels	Power reserve	Shortest switching times	Programmable every	Type of contact	Operating voltage	Type	Article number
Daily program 1	1	–	15 min	15 min	Changeover contact	230 V AC	SYN 169 s	1690801
		3 days	15 min	15 min	Changeover contact	230 V AC	SUL 189 s	1890801
						110 V AC	SUL 189 s 110V	1891801

Time and light control

Analogue time switches, Front panel installation/wall installation

Technical data

	SYN 169 s	SUL 189 s	SUL 189 s 110V
Operating voltage	230 V AC		110 V AC
Frequency	50 Hz	50–60 Hz	
Installation type	Front panel installation/wall installation		
Program	Daily program		
Power reserve	–	3 days, full power reserve approx. 3 days after connection to operating voltage	
Switching capacity at 250 V AC, $\cos \varphi = 1$	10 A		
Switching capacity at 250 V AC, $\cos \varphi = 0,6$	2 A		
Shortest switching times	15 min		
Programmable every	15 min		
Time accuracy at 25 °C	Synchronised with mains	$\leq \pm 1$ s/day (quartz)	
Stand-by consumption	0,9 W	0,5 W	
Type of protection	IP 20		
Protection class	II according to EN 60 730-1		
Ambient temperature	– 10 °C ... +55 °C		

Accessories



Snap-on mounting 72 x 72

↳ Art.No.: 9070071

Details page 352

Scale drawings

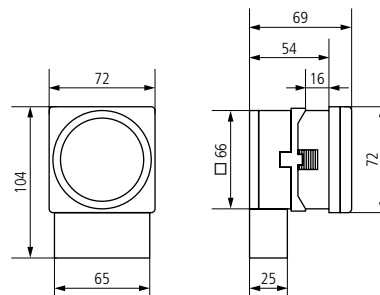

SYN 169 s, SUL 189 s

Connection diagrams

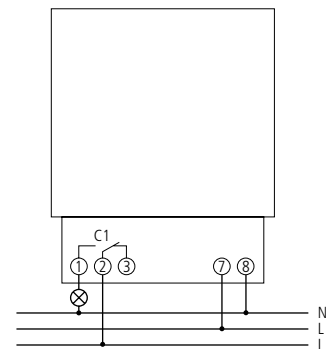

SYN 169 s, SUL 189 s



Time and light control

Analogue time switches, Front panel installation / wall installation



SYN 269 h

SUL 289 g

Description

Common functions

- Analogue time switch with daily or weekly program (switching disc can be turned)
- Tappets
- Shortest switching time: 20 minutes or 2 hours
- Clock hands for time display
- Switching status display

SYN 269 h

- 1 channel
- Without power reserve
- Synchronised with mains
- Switching preselection
- Permanent ON/OFF switch
- Simple summer/winter time correction
- 32 tappets included in delivery

SUL 289 h

- 1 channel
- With power reserve
- Quartz controlled
- Switching preselection
- Permanent ON/OFF switch
- Simple summer/winter time correction
- 32 tappets included in delivery

SUL 289 g

- 2 channels
- With power reserve
- Quartz controlled
- 49 tappets included in delivery

Product selection

Program	Number of channels	Power reserve	Shortest switching times	Programmable every	Type of contact	Operating voltage	Type	Article number
Daily program	1	-	20 min, 2 h	5 min, 30 min	Changeover contact	230 V AC	SYN 269 h	2690008
		3 days	20 min, 2 h	5 min, 30 min	Changeover contact	230 V AC	SUL 289 h	2890008
	2	3 days	20 min, 2 h	5 min, 30 min	Changeover contact	230 V AC	SUL 289 g	2890033

Time and light control

Analogue time switches, Front panel installation/wall installation

Technical data

	SYN 269 h	SUL 289 h	SUL 289 g
Operating voltage	230 V AC		
Frequency	50 Hz	50–60 Hz	
Installation type	Front panel installation/wall installation		
Program	Daily program, Weekly program		
Power reserve	–	3 days, full power reserve approx. 3 days after connection to operating voltage	
Switching capacity at 250 V AC, $\cos \varphi = 1$	10 A		
Switching capacity at 250 V AC, $\cos \varphi = 0,6$	2 A		
Shortest switching times	20 min, 2 h		
Programmable every	5 min, 30 min		
Time accuracy at 25 °C	Synchronised with mains	$\leq \pm 1$ s/day (quartz)	
Stand-by consumption	0,9 W	0,5 W	
Type of protection	IP 20		
Protection class	II according to EN 60 730-1		
Ambient temperature	– 10 °C ... +55 °C		

Accessories



Snap-on mounting 72 x 72

↳ Art.No.: 9070071

Details page 352

Scale drawings

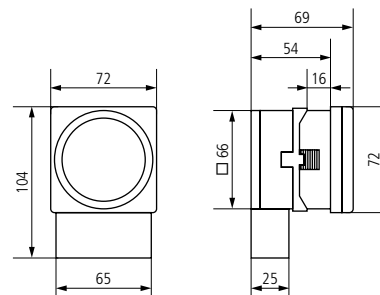

Connection diagrams

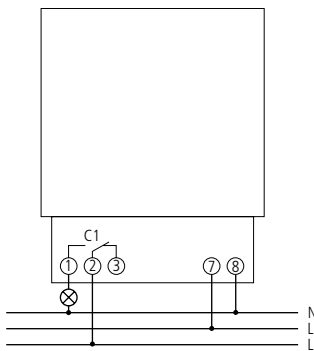

SYN 269 h, SUL 289 h

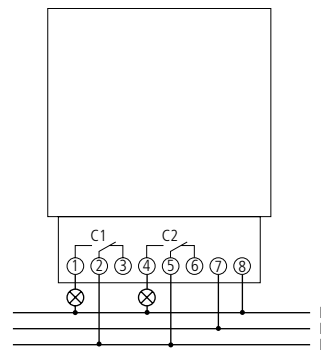

SUL 289 g

Time and light control

Analogue time switches, Front panel installation/wall installation



TM 179 h

SUL 189 hw

Description

Common functions

- Analogue time switch
- Switching status display
- 6 tappets included in delivery

TM 179 h

- 60 minute program
- 1 channel
- Without power reserve
- Synchronised with mains
- Tappets
- Shortest switching time: 75 seconds
- Switching preselection

SUL 189 hw

- Daily/weekly program and 1/2 day OFF function for the weekdays
- 1 channel (with series connection of 2 the contacts)
- With power reserve
- Quartz controlled
- Tappets and turning segments
- Shortest switching time: 30 minutes (12 hours for the 1/2 day OFF function)

Product selection

Program	Number of channels	Power reserve	Shortest switching times	Programmable every	Type of contact	Operating voltage	Type	Article number
60 minutes program	1	-	1,25 min	18,5 s	Changeover contact	230 V AC	TM 179 h	1790008
Daily/weekly program with 1/2 day OFF function	1	3 days	30 min, 12 h	15 min, 12 h	Changeover contact	230 V AC	SUL 189 hw	1890108

Time and light control

Analogue time switches, Front panel installation/wall installation

Technical data

	TM 179 h	SUL 189 hw
Operating voltage	230 V AC	
Frequency	50 Hz	50–60 Hz
Installation type	Front panel installation/wall installation	
Program	60 minutes program	Daily/weekly program with 1/2 day OFF function
Power reserve	–	3 days, full power reserve approx. 3 days after connection to operating voltage
Switching capacity at 250 V AC, $\cos \varphi = 1$	10 A	
Switching capacity at 250 V AC, $\cos \varphi = 0,6$	2 A	
Shortest switching times	1,25 min	30 min, 12 h
Programmable every	18,5 s	15 min, 12 h
Time accuracy at 25 °C	Synchronised with mains	$\leq \pm 1$ s/day (quartz)
Stand-by consumption	0,9 W	0,5 W
Type of protection	IP 20	
Protection class	II according to EN 60 730-1	
Ambient temperature	–10 °C ... +55 °C	

Accessories



Snap-on mounting 72 x 72

↳ Art.No.: 9070071

Details page 352

Scale drawings

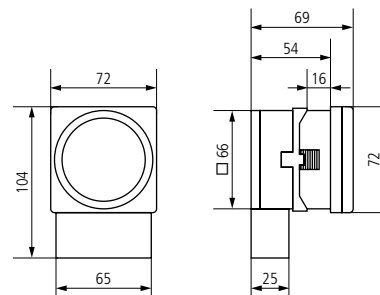

Connection diagrams

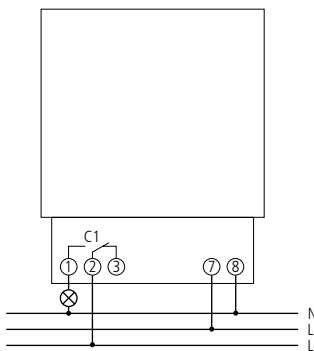

TM 179 h

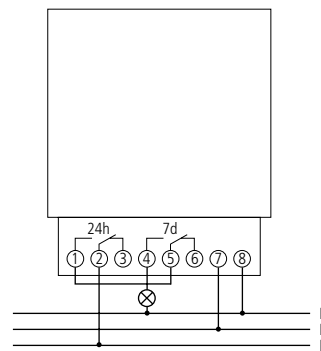

SUL 189 hw

Time and light control

Analogue time switches, Wall installation/3-point mounting



SUL 285/2 T

Description

- Analogue tariff time switch with daily program
- 2 channels
- With power reserve (exchangeable NiMH rechargeable battery)
- Quartz controlled
- Tappets
- Shortest switching time: 20 minutes
- Clock hands for time display
- Switching status display
- Simple summer/winter time correction
- Control LED for battery change
- 32 tappets included in delivery

Product selection

Program	Number of channels	Power reserve	Shortest switching times	Programmable every	Type of contact	Operating voltage	Type	Article number
Daily program	2	6 days	20 min	5 min	Changeover contact	110–230 V AC	SUL 285/2 T	2850033

Technical data

SUL 285/2 T			
Operating voltage	110–230 V AC	Shortest switching times	20 min
Frequency	50–60 Hz	Programmable every	5 min
Installation type	Wall installation/3-point mounting	Time accuracy at 25 °C	± 1 s/day (quartz)
Program	Daily program	Stand-by consumption	0,6 W
Power reserve	6 days, full power reserve approx. 3 days after connection to operating voltage	Type of protection	IP 54
Switching capacity at 250 V AC, cos φ = 1	6 A	Protection class	II according to EN 62 054-21
Switching capacity at 250 V AC, cos φ = 0,6	2 A	Ambient temperature	–10 °C ... +55 °C

Scale drawings

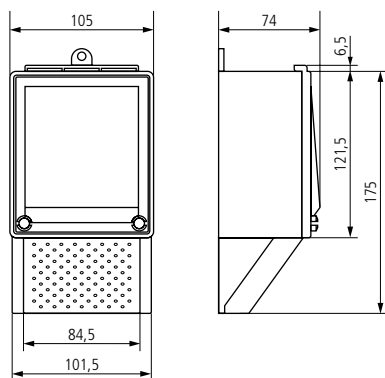

SUL 285/2 T

Connection diagrams

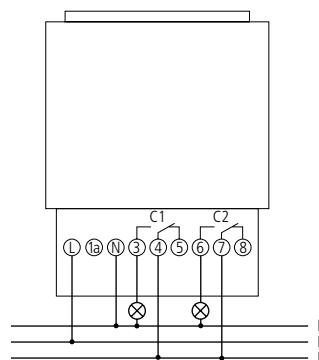

SUL 285/2 T



Description

Common functions

- Analogue plug-in timer
- 1 channel
- Without power reserve
- Synchronised with mains
- Use with earthed sockets
- Switching preselection
- Switching status display

theben-timer 26

- Daily program
- 96 switching segments
- Shortest switching time: 15 minutes

theben-timer 26 IP 44

As theben-timer 26, but:

- Waterproof protection for damp locations and outdoor areas
- Transparent cover

theben-timer 27

- Weekly program
- 84 switching segments
- Shortest switching time: 2 hours

* According to guarantee conditions, see www.theben.de/en/guarantee

Product selection

Program	Shortest switching times	Programmable every	Type of contact	Operating voltage	Type	Article number
Daily program	15 min	15 min	NO contact	230 V AC	theben-timer 26	0260030
				230 V AC	theben-timer 26 IP 44	0260855
Weekly program	2 h	2 h	NO contact	230 V AC	theben-timer 27	0270930

Technical data

	theben-timer 26	theben-timer 26 IP 44	theben-timer 27
Operating voltage	230 V AC		
Frequency	50 Hz		
Installation type	Plug-in		
Program	Daily program		Weekly program
Switching capacity at 250 V AC, cos φ = 1	16 A		
Switching capacity at 250 V AC, cos φ = 0,6	4 A		
LED lamp < 2 W (typ.)	40 W		
LED lamp > 2 W (typ.)	400 W		
Shortest switching times	15 min		2 h
Programmable every	15 min		2 h
Time accuracy at 25 °C	Synchronised with mains		
Stand-by consumption	0,8 W		
Type of protection	IP 20	IP 44	IP 20
Protection class	II according to EN 60 730-1		
Ambient temperature	-40 °C ... +55 °C		

Time and light control

Analogue time switches, Surface-mounted, Drive with quick fastening for DIN rail



FRI 77 g

FRI 77 g-2

Description

Common functions

- Analogue cooling time switch with daily and short time program
- Tappet
- 2 separate switching discs

FRI 77 g

- 2 channels
- Wall-mounted
- 8 tappets included in delivery
- Optional delayed switching on of fan

FRI 77 h-2

- 1 channel
- Drive with quick fastening for DIN rail
- 6 tappets included in delivery

FRI 77 g-2

- 2 channels
- Drive with quick fastening for DIN rail
- 8 tappets included in delivery
- Optional delayed switching on of fan

Product selection

Type of contact	Installation type	Shortest switching times	Programmable every	Operating voltage	Type	Article number
Changeover contact	Surface-mounted	2 min, 1 h	1 min, 1 h	230 V AC	FRI 77 g	0770033
	Drive with quick fastening for DIN rail	2 min, 1 h	1 min, 1 h	230 V AC	FRI 77 h-2	0770802
					FRI 77 g-2	0770832

Analogue time switches, Surface-mounted, Drive with quick fastening for DIN rail

Technical data

	FRI 77 g	FRI 77 h-2	FRI 77 g-2
Operating voltage	230 V AC		
Frequency	50 Hz		
Installation type	Surface-mounted	Drive with quick fastening for DIN rail	
Program	Daily and defrost program		
Switching capacity at 250 V AC, $\cos \varphi = 1$	16 A		
Switching capacity at 250 V AC, $\cos \varphi = 0,6$	2,5 A		
Shortest switching times	2 min, 1 h		
Programmable every	1 min, 1 h		
Time accuracy at 25 °C	Synchronised with mains		
Stand-by consumption	0,9 W		
Type of protection	IP 20	IP 00	
Protection class	II according to EN 60 730-1		
Ambient temperature	-10 °C ... +50 °C		

Scale drawings

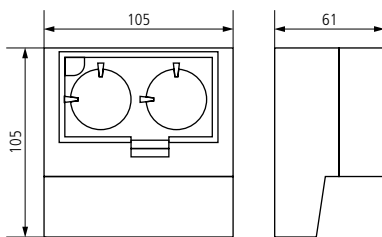

FRI 77 g

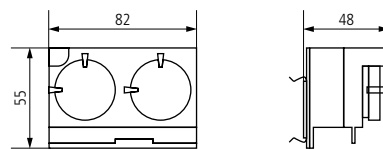

FRI 77 h-2, FRI 77 g-2

Connection diagrams

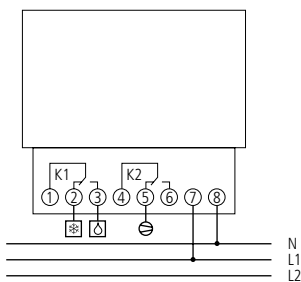

FRI 77 g, FRI 77 g-2

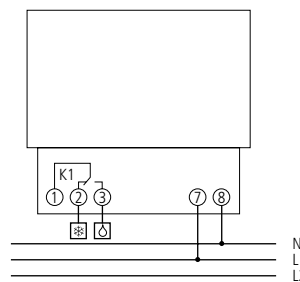

FRI 77 h-2

ELPA 8

Getting you safely up and down the stairs



Tried and tested millions of times over

The production figures speak for themselves – millions of ELPA 8 units have been produced and put into service over the past few years.

5 year warranty*

0 W standby

With features such as the following, it is little wonder that the ELPA 8 is the best selling staircase light timer switch on the market: incredibly easy time setting, an absolute scale that allows you to read the delay time directly and 0 W consumption during standby.

0 Watt 0 W standby power

The ELPA 8 consumes 0 W of power during standby operation so it saves energy as well.

Simple setting

The ELPA 8 features a rotary control with an absolute scale, making it really easy for you to see, access and change the settings.

5 5 year warranty

The ELPA 8 stands out thanks to its top quality and reliability. And it comes with a five-year warranty.

Reliable: Install and forget all about it

Due to the stringent testing requirements at our in-company laboratory (e.g. 40,000 switching cycles), we more than meet the standard. This quality is also confirmed by an external VDE test. The brand on the outside is what is being installed!

Toggle switch for continuous light

The toggle switch allows you to change the setting to continuous light with a simple flick of the finger. And that means no more fumbling around in the dark when you are trying to cleaning the stairs, for example.

Cadmium-free contacts

We use environmentally friendly AgSnO_2 materials for our switching contacts. These offer very good contact and switching properties, such as higher burn-off resistance, increased welding resistance and a significantly reduced tendency towards material migration during direct current operation.

For technical details, see page 286 onwards.

* In accordance with the warranty conditions, see www.theben.de/guarantee



Optimised for LEDs

LED behaviour can vary significantly. To respond to this correctly, it's good to have a safe and reliable solution, such as the ELPA 6 plus from Theben (page 288).

You can find additional products and versions at www.theben.de/elpa-en

TIME AND LIGHT CONTROL

Staircase time switches

	Setting range time	Key input	Multi-voltage input	Switch-off pre-warning	Long-time function	Zero-cross switching	Without stand-by consumption	Type	Page
DIN rail, electronic with multi-function									
	0,5–20 min	150 mA	✓	✓	60 min	✓	–	ELPA 1	284
			–	✓	60 min	✓	–	ELPA 6	284
								ELPA 6 plus	284
DIN rail, Electronic									
	0,5–20 min	150 mA	✓	–	–	–	–	ELPA 3	286
			–	–	–	–	–	ELPA 7	286
DIN rail, Electro-mechanical									
	1–7 min	50 mA	–	–	–	–	✓	ELPA 8	288
								ELPA 9	288
Flush-mounted, electronic with multi-function									
	0,5–20 min	30 mA	✓	✓	60 min	✓	–	ELPA 041	290
Flush-mounted, electronic with switch-off pre-warning									
	0,5–20 min	30 mA	–	–	–	✓	–	ELPA 047	290



Time and light control

Staircase time switches, DIN rail, electronic with multi-function, Electronic



Description

Common functions

- Staircase time switch, electronic
- Terminal layout same as ELPA 8
- Extremely accurate
- Push button input with electronic overload protection
- Automatic 3 or 4 conductor detection (4 conductor with connection for floor lighting, 3 conductor no longer permitted for new systems)

ELPA 1

- Zero-cross switching for relay-saving switching and high lamp loads
- Multi-functional device with 10 available functions, set at the front of the device
- Additional multi-voltage input electrically isolated for AC/DC 8...240 V, e.g. für inter-coms
- Switch-off pre-warning (two double flashes) in accordance with DIN 18015-2 to avoid sudden darkness

- Extended function activated via long button press
- Immediate secondary switching (stair light switch) or prematurely switched off (pulse switch with switch-off delay)
- Permanent switch
- Electronic pulse light

ELPA 6

- Zero-cross switching for relay-saving switching and high lamp loads
- Multi-functional device with 10 available functions, set at the front of the device
- Switch-off pre-warning (two double flashes) in accordance with DIN 18015-2 to avoid sudden darkness
- Extended function activated via long button press
- Immediate secondary switching (stair light switch) or prematurely switched off (pulse switch with switch-off delay)
- Permanent switch
- Electronic pulse light

ELPA 6 plus

As ELPA 6 but:

- Switch-off pre-warning (two flashes) optimized for switching LEDs

ELPA 3

- Additional multi-voltage input electrically isolated for AC/DC 8...240 V, e.g. für inter-coms
- Immediate secondary switching
- Toggle switch for permanent light

ELPA 7

As ELPA 3 but:

- Without multi-voltage input

Product selection

Incandescent lamp load	Multi-function	Multi-voltage input	Switch-off pre-warning	Zero-cross switching	Type	Article number
3600 W	✓	✓	✓	✓	ELPA 1	0010002
		–	✓	✓	ELPA 6	0060002
		–	–	–	ELPA 6 plus	0060003
2300 W	–	✓	–	–	ELPA 3	0030002
		–	–	–	ELPA 7	0070002

Technical data

	ELPA 1	ELPA 6	ELPA 6 plus	ELPA 3	ELPA 7
Operating voltage	220–240 V AC				
Frequency	50–60 Hz				
Stand-by consumption	0,9 W		0,7 W		
Glow lamp load	150 mA				
Setting range time	0,5–20 min				
3/4-way conductors	Automatic				
Type of contact	NO contact				
Switching output	Not potential-free (230 V)				
Incandescent/halogen lamp load	3600 W			2300 W	
Fluorescent lamp load (conventional) lead-lag circuit	3600 VA			2300 VA	
Energy saving lamps	250 W			90 W	
LED lamp < 2 W (typ.)	55 W			20 W	
LED lamp 2–8 W (typ.)	600 W			180 W	
LED lamp > 8 W (typ.)	600 W			180 W	
Switching capacity	16 AX (at 230 V AC, cos φ = 0.3), 16 A (at 230 V AC, cos φ = 1)			10 AX (at 230 V AC, cos φ = 0.3), 16 A (at 230 V AC, cos φ = 1)	
Test approval	VDE				
Ambient temperature	–25 °C ... +50 °C				
Protection class	II				
Type of protection	IP 20				

Accessories



Wall mounting kit 17,5 mm

↳ Art.No.: 9070065

Details page 352



Front panel kit

↳ Art.No.: 9070001

Details page 352



Connection diagrams

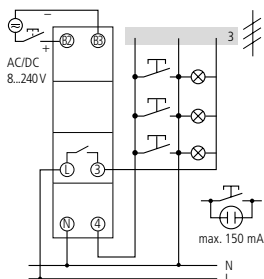

ELPA 1, ELPA 3

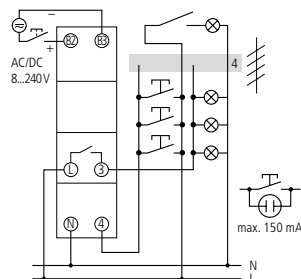

ELPA 1, ELPA 3

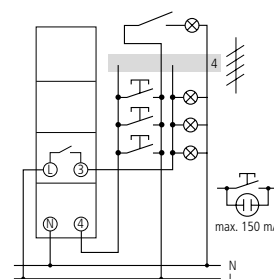

ELPA 6, ELPA 6 plus, ELPA 7

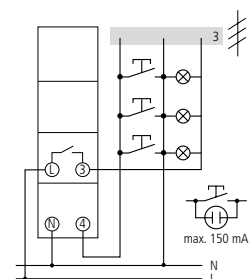

ELPA 6, ELPA 6 plus, ELPA 7

Time and light control

Staircase time switches, DIN rail, Electro-mechanical



Description

Common functions

- Staircase time switch, electro-mechanical
- No closed-circuit current consumption
- Toggle switch for permanent light ON
- Reliable due to synchronous motor drive
- Simplest possible time setting and direct delay time readout on absolute scale
- Precision mechanics and therefore exact switching period
- Very low sensitivity to interference

* According to guarantee conditions, see www.theben.de/en/guarantee

ELPA 8

- 4 conductor with floor lighting connection
- 3 conductor without floor lighting (no longer permitted for new systems)
- Retriggerable

ELPA 9

- 3 conductor connection and floor lighting, but without secondary switching (no longer permitted for new systems)
- Terminal layout same as ELPA 8

Product selection

Incandescent lamp load	Setting range time	Without stand-by consumption	Switch-off pre-warning	3/4-way conductors	Secondary switching	Type	Article number
2300 W	1–7 min	✓	–	Yes	After 30 s	ELPA 8	0080002
				Only 3-way conductor	No	ELPA 9	0090001

Time and light control

Staircase time switches, DIN rail, Electro-mechanical

Technical data

	ELPA 8	ELPA 9
Operating voltage	230 V AC	
Frequency	50 Hz	
Stand-by consumption	0 W	
Glow lamp load	50 mA	
Setting range time	1 – 7 min	
3/4-way conductors	Yes	Only 3-way conductor
Type of contact	NO contact	
Switching output	Not potential-free (230 V)	
Incandescent/halogen lamp load	2300 W	
Energy saving lamps	150 W	
LED lamp < 2 W (typ.)	30 W	
LED lamp 2 – 8 W (typ.)	300 W	
LED lamp > 8 W (typ.)	300 W	
Switching capacity	6 AX (at 230 V AC, $\cos \varphi = 0.3$), 16 A (at 230 V AC, $\cos \varphi = 1$)	
Test approval	VDE	–
Ambient temperature	–10 °C ... +50 °C	
Protection class	II	
Type of protection	IP 20	

Accessories



Wall mounting kit 17,5 mm

↳ Art.No.: 9070065

Details page 352



Front panel kit

↳ Art.No.: 9070001

Details page 352



Connection diagrams

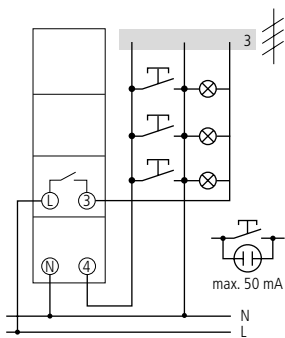

ELPA 8

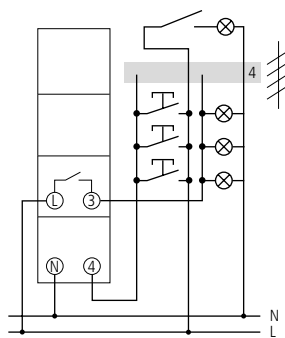

ELPA 8

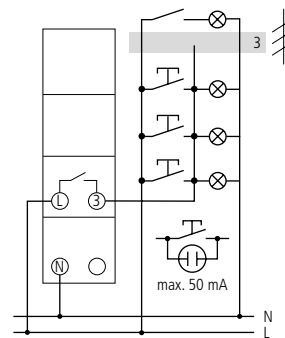

ELPA 9

Time and light control

Staircase time switches, Flush-mounted

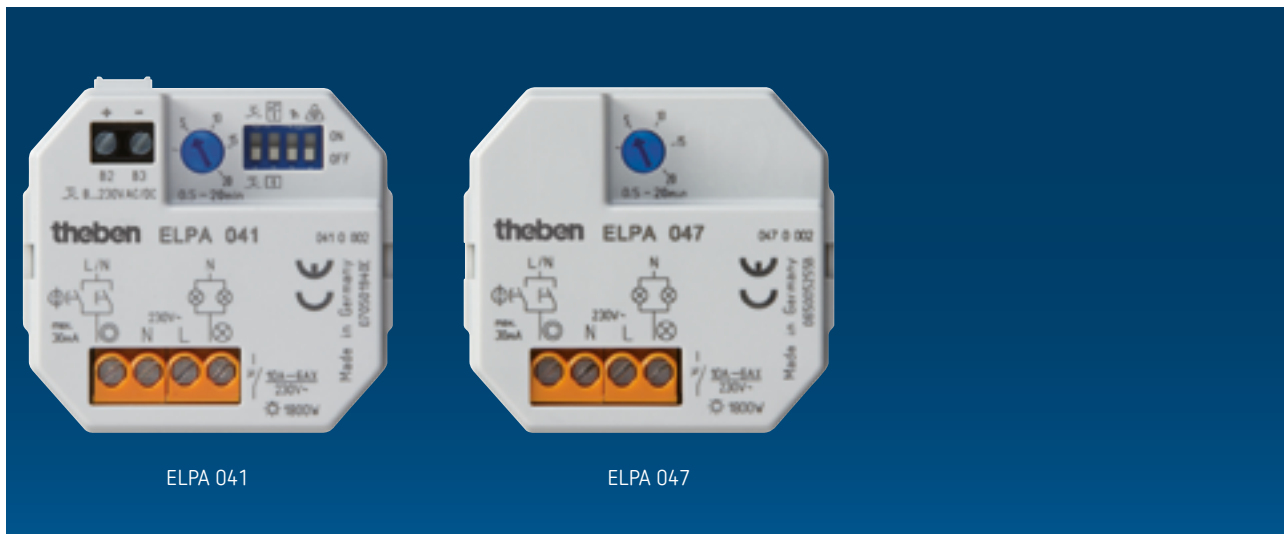

ELPA 041

ELPA 047

Description

Common functions

- Flush-mounted staircase time switch, electronic
- Suitable for upgrades and new installation
- Zero-cross switching for relay-saving switching and high lamp loads
- Push button input with electronic overload protection
- Automatic 3 or 4 conductor detection (4 conductor with connection for floor lighting, 3 conductor no longer permitted for new systems)
- Extremely accurate
- Immediate secondary switching

ELPA 041

- Multi-functional device with 12 available functions, set at the front of the device
- Switch or push button connectable, i.e. existing switches can be used (e.g. when updating)
- Additional multi-voltage input electrically isolated for AC/DC 8...240 V, e.g. für inter-coms
- Switch-off pre-warning (two double flashes) in accordance with DIN 18015-2 to avoid sudden darkness
- 60 min. extended function activated via long button press
- Immediate secondary switching (stair light switch) or prematurely switched off (pulse switch with switch-off delay)

ELPA 047

- Push button connectable

Product selection

Incandescent lamp load	Multi-function	Multi-voltage input	Switch-off pre-warning	Zero-cross switching	Type	Article number
1800 W	✓	✓	✓	✓	ELPA 041	0410002
	-	-	-	✓	ELPA 047	0470002

Technical data

	ELPA 041	ELPA 047
Operating voltage	230 V AC	
Frequency	50–60 Hz	
Stand-by consumption	0,1 W	
Glow lamp load	30 mA	
Setting range time	0,5–20 min	
3/4-way conductors	Automatic	
Type of contact	NO contact	

Time and light control

Staircase time switches, Flush-mounted

	ELPA 041	ELPA 047
Switching output	Not potential-free (230 V)	
Incandescent/halogen lamp load	1800 W	
Fluorescent lamp load (conventional) lead-lag circuit	1200 VA	
Fluorescent lamp load (conventional) parallel-corrected	580 VA, 54 μ F	
Energy saving lamps	110 W	
LED lamp < 2 W (typ.)	20 W	
LED lamp 2-8 W (typ.)	250 W	
LED lamp > 8 W (typ.)	250 W	
Switching capacity	6 AX (at 230 V AC, $\cos \varphi = 0.3$), 10 A (at 230 V AC, $\cos \varphi = 1$)	
Test approval	VDE	
Ambient temperature	-25 °C ... +45 °C	
Protection class	II	
Type of protection	IP 20	

Scale drawings

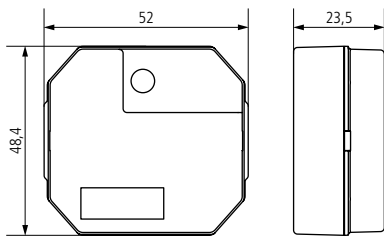

ELPA 041, ELPA 047

Connection diagram

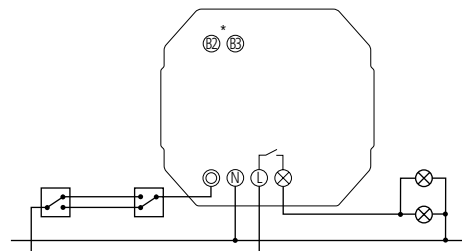

ELPA 041

* with switch
(with three-way switch the multi-voltage input is not usable)



Connection diagrams

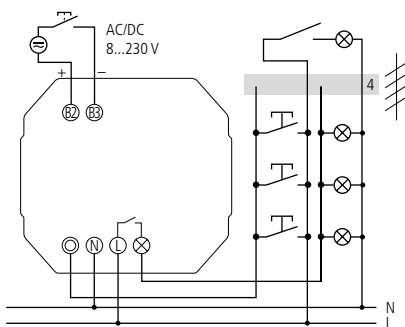

ELPA 041

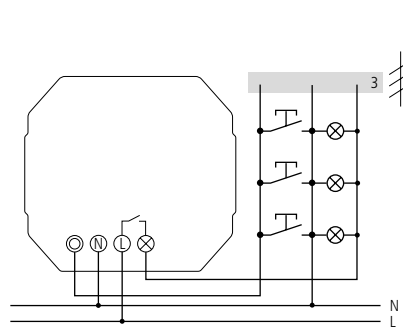

ELPA 047

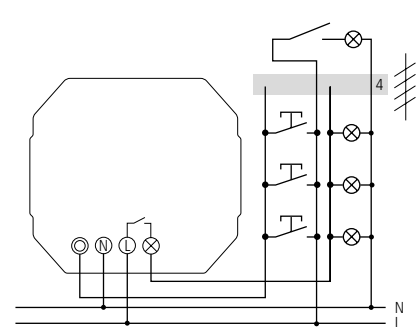

ELPA 047

Premium class!

DIMAX 544 plus P

Flush-mounted universal dimmer



Minimum width. Maximum power.

Thanks to the compact housing measuring just 44 x 44 x 20 mm, the new DIMAX can be quickly mounted in the flush-mounted box, even behind a switch.

The DIMAX 544 plus P boasts a whole range of setting options for various LED dimming responses as well as convenient programming via the smartphone app.



Compact housing

For convenient installation in the flush-mounted box



Ideal for LEDs

Thanks to optimised zero-cross switching



Handy memory function

Saves the most recent light level value set



Load detection for R, L and C loads

For controlling ventilation systems



Convenient snooze function

Lets you glide gently into the realm of dreams



Adjustable dimming response

For ideal dimming of LEDs



Password protection possible

Prevents unauthorised access to your devices



App for Android and iOS

Convenient operation via the app



Safety first

The switch-off pre-warning of the DIMAX 544 plus P does not leave you standing in the dark in the staircase, but warns you by gently dimming the light.



Safety first

The switch-off pre-warning of the DIMAX 544 plus P does not leave you standing in the dark in the staircase, but warns you by gently dimming the light.



Custom lighting scenarios

Conveniently configured and activated via smartphone





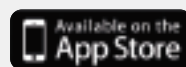

Adjustable staircase light function

Convenient operation via the app



Long range. Easy programming.

Activate the desired lighting scenarios conveniently via your smartphone. The MAXplus app is available for Android and iOS.

	Universal dimmer for R, L, and C loads	Mounting type	Multi-voltage input	Multifunction	Operation via App possible	Type	Page
	✓	DIN rail	✓	–	–	DIMAX 532 plus	292
				✓	–	DIMAX 534 plus	292
		Flush-mounted	–	–	–	DIMAX 541 plus E	294
				–	–	DIMAX 542 plus S	294
				–	✓	DIMAX 544 plus P	294



Time and light control

Dimmer



DIMAX 532 plus

DIMAX 534 plus

Description

Common functions

- Universal dimmer for R, L and C loads with automatic load detection
- Switch-on brightness can be saved individually
- Adjustable minimum brightness (required for ESL and LED)
- Multi-voltage input, e.g. for intercoms
- Low stand-by consumption
- Memory function in the event of power failure
- Automatic electronic overload and overheating switch-off
- Dimming switch-on function

- Permanent ON function (test function)
- No minimum load requirement
- Soft ON and Soft OFF protects the light
- The dimming output can be upgraded by using additional dimmboosters „DMB 1 T KNX“ - dimming output 300 W/VA for each dimmbooster

DIMAX 534 plus

- Comfort setting with wake-up and snooze function (can be deactivated), e.g. for children's bedrooms
- Adjustable dimming rate (with automatic functions)

- One and two button operation for ease of use
- Up to 3 light scenes can be called up via separate input (diode module required for more than one light scene)
- Central OFF/ON or light scene for up to 10 devices possible with one push button
- Staircase light function with dimming function in accordance with DIN 18015-2 (resettable, long-time function)
- Can be controlled by push buttons or switches e.g. for combination with presence detectors or time switch

Product selection

Load detection	Optimized for energy-saving lamps	Light settings	Multi-function	Type	Article number
√	√	-	-	DIMAX 532 plus	5320001
		√	√	DIMAX 534 plus	5340001

Technical data

	DIMAX 532 plus	DIMAX 534 plus
Operating voltage	230 V AC	
Frequency	50 Hz	
Stand-by consumption	0,2 W	
Incandescent/halogen lamp load	400 W	
Transformer electronic (C)	300 W	
Transformer inductive (L)	400 W	
Energy saving lamps	Trailing edge: 400 W	
LED lamp (typ.)	Trailing edge: 400 W	
Ambient temperature	-30 °C ... +50 °C	
Protection class	II	
Type of protection	IP 20	

Accessories



Wall mounting kit 17,5 mm
↳ Art.No.: 9070065
Details page 352



Front panel kit
↳ Art.No.: 9070001
Details page 352

Diode module

for DIMAX 534 plus
↳ Art.No.: 9070367
Details page 360

Compensation module LED

↳ Art.No.: 9070825
Details page 360

Connection diagrams

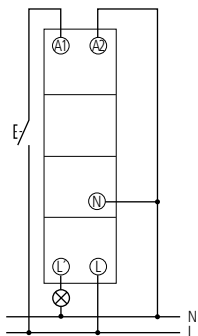

DIMAX 532 plus

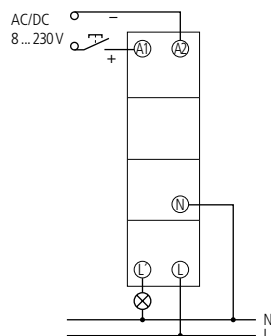

DIMAX 532 plus

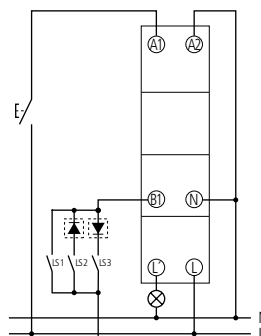

DIMAX 534 plus

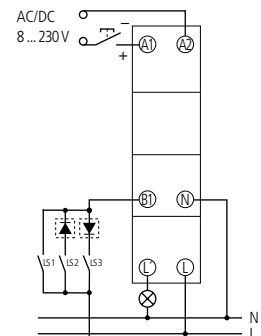

DIMAX 534 plus



Time and light control

Dimmer



DIMAX 541 plus E

DIMAX 542 plus S

DIMAX 544 plus P

Description

Common functions

- Universal dimmer for R, L and C loads with automatic load detection
- Optimised settings for LEDs, incandescent lamps
- Easy installation thanks to a highly compact housing
- Ideal for all dimmable LEDs and halogen lamps
- Memory function saves the most recently set light level value and then dims to this value the next time it is switched on
- Convenient snooze function

DIMAX 541 plus E

- Push button operation

DIMAX 542 plus S

- Push button operation, setting via potentiometer
- Adjustable minimum brightness for LEDs
- „Gentle” lamp-conserving function for switching on and off
- Automatic detection of the load type
- Overheating protection against overload
- Short-circuit protection

DIMAX 544 plus P

- Operation by button or app via Bluetooth Low Energy
- Adjustable minimum brightness for LEDs
- Adjustable dimming response
- Adjustable staircase light function
- App for Android and iOS
- Special load setting
- Sequential scenes
- Password protection possible
- „Gentle” lamp-conserving function for switching on and off
- Automatic detection of the load type
- Overheating protection against overload
- Short-circuit protection

Product selection

Load detection	Optimized for energy-saving lamps/LED	Light settings	Operation via App possible	Type	Article number
✓	✓	–	–	DIMAX 541 plus E	5410130
		–	–	DIMAX 542 plus S	5420130
		✓	✓	DIMAX 544 plus P	5440130

Technical data

	DIMAX 541 plus E	DIMAX 542 plus S	DIMAX 544 plus P
Operating voltage		230 V AC	
Frequency		50–60 Hz	
Stand-by consumption		0,15 W	
Incandescent/halogen lamp load		250 W	
Transformer electronic (C)		250 W	
Energy saving lamps		Trailing edge: 200 W	
LED lamp (typ.)		Trailing edge: 250 W	
Ambient temperature		–25 °C ... +45 °C	

Accessories



Compensation module LED

↳ Art.No.: 9070825

Details page 360

Scale drawings

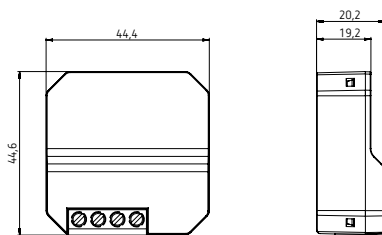

Connection diagrams

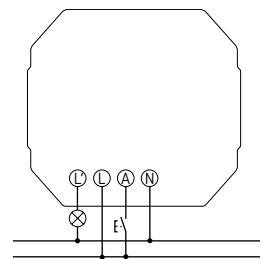

Easy operation via app (DIMAX 544 plus P)



LUNA top3 – Daylight-based adjustments

Now possible via a smartphone app



The new LUNA top3 digital twilight switches from Theben are reaching new heights in terms of functionality, programmability and energy efficiency. Twilight programmes can be easily controlled using an app and transferred to the twilight switch via Bluetooth Low Energy. Thanks to the newly developed zero-cross switching, you can keep the high inrush currents of LEDs firmly under control. top3 can handle 5 times more LED power than top2 (max. 600 W/ 800 A/200 μ s).

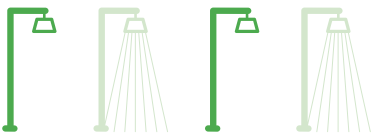

Practical, reliable and low-maintenance: Channel switching and locking

The new dual-channel LUNA 122 top3 twilight switch now offers a channel switching and locking feature. The channel switching option allows you to activate basic lighting while at the same time saving energy. For example, this can ensure even loads for street lighting while also increasing the maintenance intervals and life of the lamps. The channel locking feature prevents a channel from using conflicting commands which could damage connected devices (e.g. forward and return for motors).



Special programmes with yearly functions

The new LUNA 121 top3 and LUNA 122 top3 twilight switches feature a small annual program so that you can program one-off and recurring events (e.g. pre-programmed holidays which you need only select).









Maximum security against tampering

Time switch programs can only be transferred from the app to the timer if the Bluetooth OBELISK top3 is plugged into the timer. This protects your device against unwanted access by third parties and ensures maximum security against tampering. This is particularly important for devices installed in public places.

For technical details, see page 300 onwards.

TIME AND LIGHT CONTROL

Twilight switches

	Number of channels	Setting range brightness	Switch-on delay	Separate on / off switching delay	External inputs	PC interface	Program	Type of connection	Type	Page
Analogue, DIN rail										
	1	2–2000 lx	20 s	–	–	–	–	Screw terminals	LUNA 108 plus	298
		2–50000 lx	0–20 min	–	–	–	–	DuoFix spring terminals	LUNA 110 plus	298
Digital without clock, DIN rail										
	1	1–99000 lx	0–59 min	✓	1	✓	–	DuoFix spring terminals	LUNA 111 top3	300
	2	1–99000 lx	0–59 min	✓	–	✓	–	DuoFix spring terminals	LUNA 112 top3	300
Digital, DIN rail										
	1	1–99000 lx	0–59 min	✓	1	✓	Weekly program	DuoFix spring terminals	LUNA 121 top3 RC	302
	2	1–99000 lx	0–59 min	✓	–	✓	Weekly program	DuoFix spring terminals	LUNA 122 top3 RC	302
Analogue, Wall installation or mast bracket										
	1	2–200 lx	20 s	–	–	–	–	Screw terminals	LUNA 126 star E	304
		2–2000 lx	2–100 s	–	–	–	–	Screw terminals	LUNA 127 star S	304



Zeit- und Lichtsteuerung

Dämmerungsschalter, Analog, DIN-Schiene



LUNA 108 plus

LUNA 110 plus

Description

Common functions

- Analogue twilight switch
- External light sensor included in delivery
- Display of channel and switching status
- Infinitely adjustable switching brightness

LUNA 108 plus

- Fixed On and Off switching delay

LUNA 110 plus

- Adjustable On and Off switching delay
- DuoFix spring terminals
- Extended brightness levels and adjustable delay
- Five adjustable brightness levels for simple setting of lux value

- Zero-cross switching for relay-saving switching and high lamp loads (not with 24 V devices)
- Permanent OFF and permanent ON function can be set on the potentiometer
- Test function

Product selection

Setting range brightness	Switch-on delay	Type of connection	Operating voltage	Sensor (included)	Type of protection	Type	Article number
2–2000 lx	20 s	Screw terminals	230 V AC	Flush-mounted light sensor	IP 20, sensor IP 66	LUNA 108 plus EL	1080900
				Surface-mounted light sensor	IP 20, sensor IP 55	LUNA 108 plus AL	1080910
2–50000 lx	0–20 min	DuoFix spring terminals	110–230 V AC	Flush-mounted light sensor	IP 20, sensor IP 66	LUNA 110 plus EL	1080900
				Surface-mounted light sensor	IP 20, sensor IP 55	LUNA 110 plus AL	1080910



Zeit- und Lichtsteuerung Dämmerungsschalter, Analog, DIN-Schiene

Technical data

	LUNA 108 plus	LUNA 110 plus
Operating voltage	230 V AC	110–230 V AC
Frequency	50–60 Hz	
Stand-by consumption	0,3 W	0,4 W
Setting range brightness	2–2000 lx	2–50000 lx
Switch-on delay	20 s	0–20 min
Type of contact	NO contact	Changeover contact
Switching output	Potential-free	Not for SELV
Width	1 module	2 modules
Switching capacity	16 A (at 250 V AC, $\cos \varphi = 1$), 10 AX (Fluorescent lamp load)	16 A (at 250 V AC, $\cos \varphi = 1$), 16 AX (Fluorescent lamp load)
Switching capacity min.	–	<10 mA
Incandescent lamp load	2600 W	2600 W
LED lamp < 2 W (typ.)	30 W	50 W
LED lamp 2–8 W (typ.)	350 W	600 W
LED lamp > 8 W (typ.)	350 W	600 W
Energy saving lamps	90 W	270 W
Ambient temperature	–30 °C ... +55 °C	–25 °C ... +55 °C
Protection class	II, Sensor III	
Max. cable length to sensor	25 m	100 m

Accessories



Wall mounting kit 17,5 mm
for LUNA 108 plus
↳ Art.No.: 9070065
Details page 352



Wall mounting kit 35 mm
for LUNA 110 plus
↳ Art.No.: 9070064
Details page 352



Front panel kit
↳ Art.No.: 9070001
Details page 352

Surface-mounted light sensor
Details page 359

Flush-mounted light sensor
Details page 359

Connection diagrams

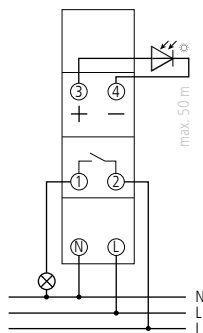

LUNA 108 plus

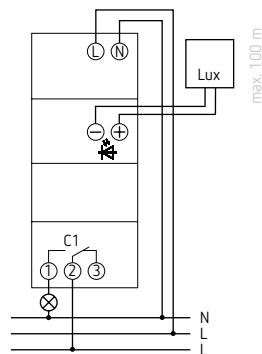

LUNA 110 plus

Time and light control

Twilight switches, Digital without clock, DIN rail



Description

Common functions

- Twilight switch/light controller
- External light sensor included in the scope of supply
- Programming by app possible
- Safe transfer via optional Bluetooth Low Energy with OBELISK top3
- Maximum security against tampering, time switch programmes can only be transferred from the app to the timer if the Bluetooth OBELISK top3 is plugged in
- Switching brightness digitally adjustable
- Adjustable on and off switching delay
- Switching brightness and switching delay can be set separately for switching on and off
- Onscreen display of channel and switching status as well as current lux value

- DuoFix load line connections
- Zero-cross switching for relay-saving switching and high lamp loads
- Up to 4 sensors can be attached
- Up to 10 devices can be connected to a digital sensor
- Interface for OBELISK top2 memory card (PC programming)
- Extended brightness range
- Permanent ON/OFF switching
- Test function
- Switching pre-selection
- Display lighting
- PIN coding
- Hour counter

LUNA 111 top3

- 1 channel
- External input

LUNA 112 top3

- 2 channels

Product selection

Number of channels	External inputs	On/off switching delay	Sensor (included)	Protection rating	Type	Article number
1	1	0–59 min	Surface-mounted light sensor	IP 20, sensor IP 55	LUNA 111 top3 AL	1110130
			Flush-mounted light sensor	IP 20, sensor IP 66 (front), ball throw tested IP 40 (back)	LUNA 111 top3 EL	1110230
2	–	0–59 min	Surface-mounted light sensor	IP 20, sensor IP 55	LUNA 112 top3 AL	1120130
			Flush-mounted light sensor	IP 20, sensor IP 66 (front), ball throw tested IP 40 (back)	LUNA 112 top3 EL	1120230

Time and light control

Twilight switches, Digital without clock, DIN rail

Technical data

	LUNA 111 top3	LUNA 112 top3
Operating voltage	110–230 V AC	
Frequency	50–60 Hz	
Standby output	0.75 W	
Brightness setting range	1–99,000 lx	
On/off switching delay	0–59 min	
Type of contact	Changeover contact	
Width	2 units	
Switching capacity	16 A (at 250 V AC, $\cos \varphi = 1$), 10 A (at 250 V AC, $\cos \varphi = 0.6$)	
Incandescent/halogen lamp load	2600 W	
LED lamp < 2 W (typ.)	50 W	
LED lamp > 2 W (typ.)	600 W	
Fluorescent lamps uncompensated	2600 W	
Fluorescent lamps, parallel-compensated	130 μ F	
Ambient temperature	–25 °C ... +55 °C	
Protection class	II, sensor III	
Max. line length to sensor	100 m	

Accessories



Bluetooth OBELISK top3

↳ Art.No.: 9070130
Details page 353



OBELISK top2 memory card

↳ Art.No.: 9070404
Details page 353



Front panel mounting kit

↳ Art.No.: 9070001
Details page 352

Light sensors

Details page 359

Wall mounting kits

Details page 352

Front panel kit

Details page 352

Connection example

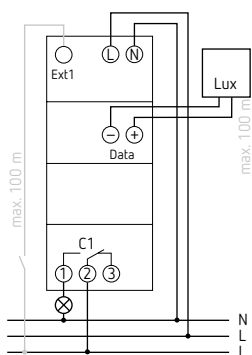

LUNA 111 top3

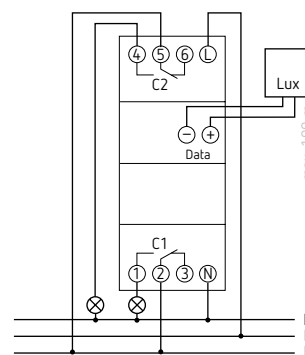

LUNA 112 top3

Time and light control

Twilight switches, Digital, DIN rail, Analogue



LUNA 121 top3

LUNA 122 top3

Description

Common functions

- Twilight switch/light controller with integrated time switch with weekly programme
- External light sensor included in the scope of supply
- Time synchronisation option via connection of an external antenna, e.g. top2/3 RC-DCF or top2/3 GPS antennas
- 3 special programmes (small annual programme)
- 84 memory locations
- Programming by app possible
- Safe transfer via optional Bluetooth Low Energy with OBELISK top3
- Maximum security against tampering, time switch programmes can only be transferred from the app to the timer if the Bluetooth OBELISK top3 is plugged in
- Switching brightness digitally adjustable
- Adjustable on and off switching delay

- Switching brightness and switching delay can be set separately for switching on and off
- Onscreen display of channel and switching status as well as current lux value
- DuoFix load line connections
- Zero-cross switching for relay-saving switching and high lamp loads
- Up to 4 sensors can be attached
- Up to 10 devices can be connected to a digital sensor
- Interface for OBELISK top2 memory card (PC programming)
- Extended brightness range
- Permanent ON/OFF switching
- Test function
- Switching pre-selection
- Display lighting
- PIN coding
- Hour counter

LUNA 121 top3 RC

- 1 channel
- External input

LUNA 122 top3 RC

- 2 channels
- Channel switching and channel lock possible

Product selection

Number of channels	External inputs	On/off switching delay	Sensor (included)	Protection rating	Type	Article number
1	1	0–59 min	Surface-mounted light sensor	IP 20, sensor IP 55	LUNA 121 top3 RC AL	1210130
			Flush-fitting light sensor	IP 20, sensor IP 66 (front), ball throw tested IP 40 (back)	LUNA 121 top3 RC EL	1210230
2	–	0–59 min	Surface-mounted light sensor	IP 20, sensor IP 55	LUNA 122 top3 RC AL	1220130
			Flush-fitting light sensor	IP 20, sensor IP 66 (front), ball throw tested IP 40 (back)	LUNA 122 top3 RC EL	1220230

Time and light control

Twilight switches, Digital, DIN rail, Analogue

Technical data

	LUNA 121 top3	LUNA 122 top3
Operating voltage	110–230 V AC	
Frequency	50–60 Hz	
Standby output	0.75 W	
Brightness setting range	1–99,000 lx	
On/off switching delay	0–59 min	
Type of contact	Changeover contact	
Width	2 units	
Switching capacity	16 A (at 250 V AC, $\cos \varphi = 1$), 10 A (at 250 V AC, $\cos \varphi = 0.6$)	
Incandescent/halogen lamp load	2600 W	
LED lamp < 2 W (typ.)	50 W	
LED lamp > 2 W (typ.)	600 W	
Fluorescent lamps uncompensated	2600 W	
Fluorescent lamps, parallel-compensated	130 μ F	
Ambient temperature	–25 °C ... +55 °C	
Protection class	II, sensor III	
Max. line length to sensor	100 m	

Accessories



Bluetooth OBELISK top3

↳ Art.No.: 9070130
Details page 353



OBELISK top2 memory card

↳ Art.No.: 9070404
Details page 353



Front panel mounting kit

↳ Art.No.: 9070001
Details page 352

Light sensors

Details page 359

Wall mounting kits

Details page 352

Front panel kit

Details page 352

Antenna RC-DCF

Details page 353

Antenna RC-GNSS

Details page 353

Antenna RC-GNSS R

Details page 353

Connection example

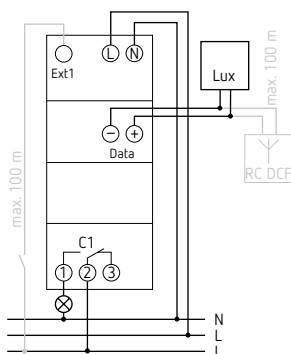

LUNA 121 top3

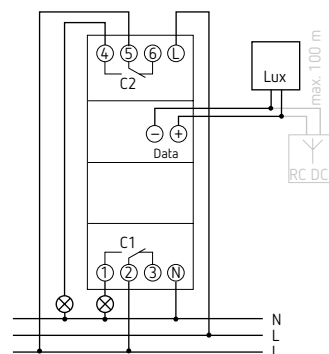

LUNA 122 top3

Time and light control

Twilight switches, Wall installation or mast bracket



Description

Common functions

- Twilight switch with integrated light sensor
- Cable feed from the back and from below
- Captive screws
- Large terminal area
- Brightness value can be set without opening the device
- Large light exposure angle (approx. 180 degrees)

LUNA 126 star E

- Fixed On and Off switching delay
- Infinitely adjustable switching brightness

LUNA 127 star S

- Adjustable On and Off switching delay
- Infinitely adjustable switching brightness
- Test function
- Teach-in function
- Timer function (1 hour on)
- Switchable brightness range: 2-100/100-2000 lux

Product selection

Setting range brightness	Switch-on delay	Switching capacity at 230 V AC	Time program	Type	Article number
2-200 lx	20 s	16 (6) A AX	-	LUNA 126 star E	1260900
2-2000 lx	2-100 s	16 (10) A AX	-	LUNA 127 star S	1270900



Time and light control

Twilight switches, Wall installation or mast bracket

Technical data

	LUNA 126 star E	LUNA 127 star S
Operating voltage	230 V AC	
Frequency	50–60 Hz	
Stand-by consumption	0,6 W	
Setting range brightness	2–200 lx	2–2000 lx
Switch-on delay	20 s	2–100 s
Type of contact	NO contact	
Switching output	Not potential-free (230 V)	
Switching capacity	16 A (at 230 V AC, $\cos \varphi = 1$), 10 AX (at 230 V AC, $\cos \varphi = 0.3$)	
Incandescent lamp load	2300 W	
Energy saving lamps	90 W	
LED lamp < 2 W (typ.)	30 W	50 W
LED lamp > 2 W (typ.)	350 W	600 W
Ambient temperature	-35 °C ... +55 °C	
Type of protection	IP 55	
Protection class	II	

Scale drawings

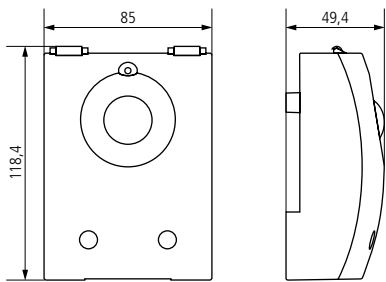

Accessories



Adapter plate LUNA star
↳ Art.No.: 9070486
Details page 359



Mast fixing S
↳ Art.Nr.: 9070928
Details page 363



LUNA star adapter mast fixing
↳ Art.Nr.: 9070793
Details page 359

Connection diagrams

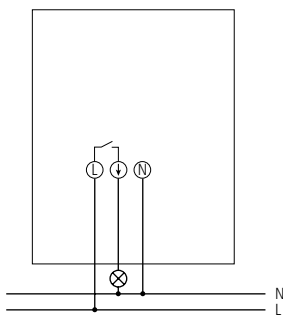

LUNA 126 star E, LUNA 127 star S





Absolute classics! Hour counters



Our tried-and-tested counters are very quick to install and can be used to record operating and service times reliably. In turn, this allows precise planning and monitoring of your production processes, maintenance cycles and warranty periods.





Description	Type	Page
-------------	------	------

Time relays



 Multi-function relay	TM 345 M	308
 Time relay with switch function	TM 345 B	308

Installation type	Size front plate	Type	Page
-------------------	------------------	------	------

Hour counters, analogue

 Front panel installation	48 x 48 mm	BZ 142-1	310
 Front panel installation		BZ 142-3	310
 Front panel installation	52 x 52 mm	BZ 143-1	310
 DIN rail	35 x 45 mm	BZ 145	310

Hour counters, digital

 Front panel installation	24 x 48 mm	BZ 146	312
 Front panel installation	48 x 48 mm	BZ 147	312
 DIN rail	35 x 45 mm	BZ 148	312

Time and light control

Time relays

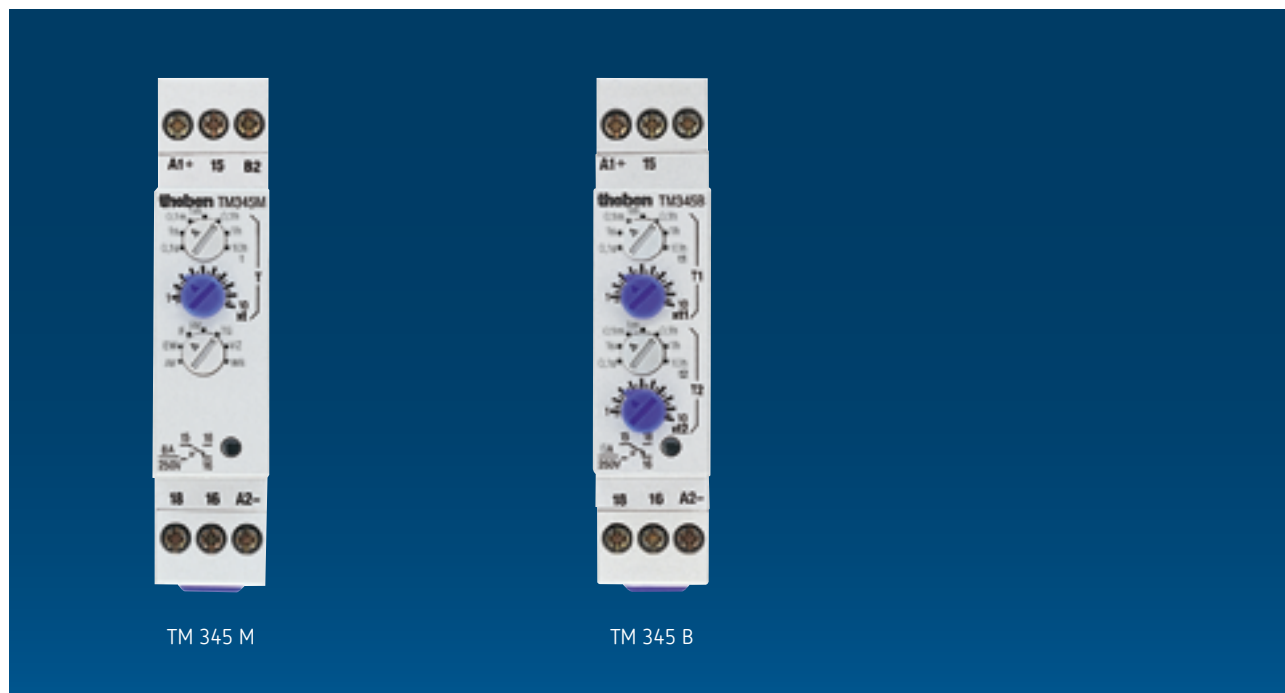

Description

Common functions

- Electronic time relay
- Can be used universally for controlling automatic processes in machines, lighting, ventilation, heating, cupboards etc.
- Precise analogue time setting
- Multi-voltage input for all supply and control voltages, no jumpers or additional terminals are required

- LED to display the switching status

TM 345 M

- Locking snap switch to select the period of time, as well as the following operating modes:
 - Response delay (AV), without control contact
 - Wipe contact (EW), without control contact
 - Release delay (RV), with control contact
 - Pulse former (IF), with control contact

- Response and release delay (VZ), with control contact
- Pulse output (WR), with control contact
- Flip-flop (TG)

TM 345 B

- With flip-flop function
- Pulse and break time independently adjustable

Product selection

Multi-function	Type	Article number
✓	TM 345 M	3450731
-	TM 345 B	3450730

1234h

Technical data

	TM 345 M	TM 345 B
Operating voltage	12–240 V AC/DC	24–240 V AC/24 V DC
Frequency	50–60 Hz	
Width	1 module	
Stand-by consumption	1 W	
Type of contact	Changeover contact	
Housing and insulation material	High-temperature resistant, self-extinguishing thermoplastic	
Switching capacity at 250 V AC, $\cos \phi = 1$	8 A	
Switching output	Potential-free	
Nominal current	10 mA–20 A < 10 ms	
Electrical service life	10 ⁵ operating cycles	
Fall back value of nominal input voltage	< 10.2 V AC/DC (as per EN 61812-1)	< 20.4 V AC/DC (as per EN 61812-1)
Type of protection	IP 20	
Protection class	II	
Ambient temperature	–20 °C ... +60 °C	

Accessories



Wall mounting kit 35 mm

for BZ 145

↳ Art.No.: 9070064

Details page 352

Connection diagrams

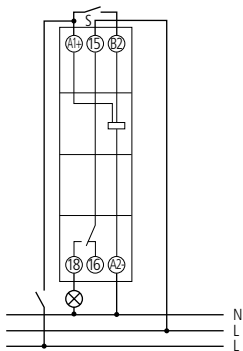

TM 345 M

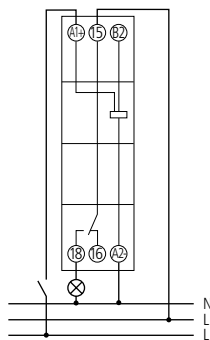

TM 345 M

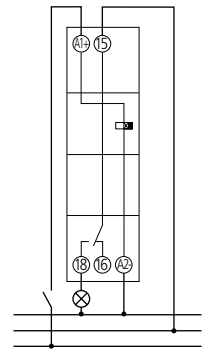

TM 345 B

1234h

Time and light control

Hour counters, analogue, front panel and DIN rail



Description

Common functions

- Hour counter with synchronous motor drive

BZ 142-1

- Front panel devices with click-in or stretch clamp supports for walls up to a maximum of 10 mm thick
- Clamp or flat plug connection 6.3 mm
- Versions for direct voltage with quartz-controlled stepper motor
- Progress display

BZ 142-3

- With plug-in base for wall installation (terminal cover required)
- Plug-in base with quick fastening for 35 mm profile rails (DIN EN 60 715)
- Screw terminals
- Contact protection to comply with accident prevention regulation BGV A3
- Housing colour: anthracite
- Versions for direct voltage with quartz-controlled stepper motor
- Progress display

BZ 143-1

As BZ 142-1

BZ 145

- Built in distributor device with quick fastening for 35 mm profile rails (DIN EN 60 715)
- Top mounting with additional terminal box cover plate, sealable
- Control panel installation with assembly kit No. 907 0 001
- Contact protection to comply with accident prevention regulation BGV A3
- Captive screw terminals

Product selection

Counting range	Installation type	Size front plate	Size of Installation section	Operating voltage	Type	Article number
99 999,99 hours without reset	Front panel installation	48 x 48 mm	46 x 46 mm	230 V AC	BZ 142-1	1420721
				10–80 V DC	BZ 142-1 10V	1420821
				230–240 V AC	BZ 142-1 230V	1420621
				24 V AC	BZ 142-1 24V	1424721
				230 V AC	BZ 142-3	1420723
		10–80 V DC	BZ 142-3 10V	1420823		
		52 x 52 mm	46 x 46 mm or ø 50 mm	230 V AC	BZ 143-1	1430721
				10–80 V DC	BZ 143-1 10V	1430821
				24 V AC	BZ 143-1 24V	1434721
				230 V AC	BZ 145	1450000
24–48 V DC	BZ 145 24V			1459024		

Time and light control

Hour counters, analogue, front panel and DIN rail

Technical data

	BZ 142-1	BZ 142-1 10V	BZ 142-1 230V	BZ 142-1 24V	BZ 142-3	BZ 142-3 10V	BZ 143-1	BZ 145	BZ 145 24V	
Operating voltage	230 V AC	10–80 V DC	230–240 V AC	24 V AC	230 V AC	10–80 V DC	230 V AC	230 V AC	24–48 V DC	
Frequency	50 Hz	–	60 Hz	50 Hz		–	50 Hz		–	
Width	–							2 modules		
Installation type	Front panel installation							DIN rail		
Counting range	99 999,99 hours without reset							99 999,9 hours without reset		
Type of protection	IP 65 (Front frame)							IP 20		
Protection class	II according to EN 60 335-1									
Ambient temperature	–20 °C ... +70 °C							–10 °C ... +70 °C		

Accessories



Cover 55 x 55 for BZ
for BZ 142-1
↳ Art.No.: 9070041
Details page 353



Cover 72 x 72 for BZ
for BZ 142-1
↳ Art.No.: 9070074
Details page 353



Wall mounting kit 35 mm
for BZ 145
↳ Art.No.: 9070064
Details page 352

Scale drawings

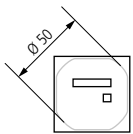

BZ 142-1

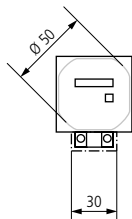
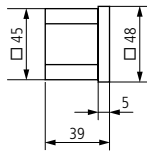

BZ 142-3

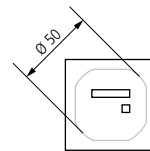
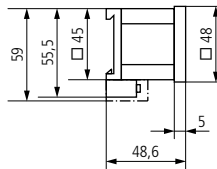

BZ 143-1

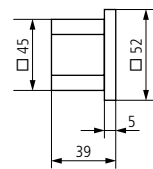

Time and light control

Hour counters, digital, front panel and DIN rail



Description

Common functions

- Digital hour counter
- With EEPROM memory provides reliable operating data capture even with loss of power
- 7-digit high-contrast LCD display
- Onscreen progress display

BZ 146

- Installation cutout 22 mm x 45 mm
- Control panel installation
- Screw terminals
- Tension clamp brackets for walls up to 5mm thick
- Quartz controlled version

BZ 147

- Installation cutout 45 mm x 45 mm
- Control panel installation
- Screw terminals
- Tension clamp brackets for walls up to 5mm thick
- Quartz controlled version

BZ 148

- For DIN rail mounting with quick fastening for 35 mm profile rails (DIN EN 60 715)
- Surface mounting with additional terminal box cover plate option
- Captive screw terminals

Product selection

Counting range	Installation type	Size front plate	Size of Installation section	Operating voltage	Type	Article number
99 999,99 hours without reset	Front panel installation	24 x 48 mm	22 x 45 mm	110–240 V AC	BZ 146	1460000
		48 x 48 mm	45 x 45 mm	110–240 V AC	BZ 147	1470000
999 999.9 hours without reset	DIN rail	35 x 45 mm	35 x 45 mm (depth 60 mm)	24–240 V AC/12–150 V DC	BZ 148	1480000

Time and light control

Hour counters, digital, front panel and DIN rail

Technical data

	BZ 146	BZ 147	BZ 148
Operating voltage	110–240 V AC		24–240 V AC/12–150 V DC
Frequency	50–60 Hz		
Width	–		2 modules
Installation type	Front panel installation		DIN rail
Counting range	99 999,99 hours without reset		999 999.9 hours without reset
Type of protection	IP 65		IP 20
Protection class	II according to EN 61010		
Ambient temperature	–30 °C ... +70 °C		–10 °C ... +70 °C

Accessories



Wall mounting kit 35 mm
for BZ 148
↳ Art.No.: 9070064
Details page 352

Connection diagrams

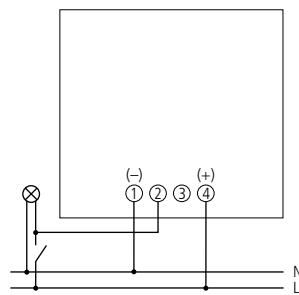

BZ 146, BZ 147

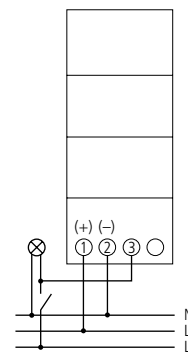

BZ 148

Scale drawings

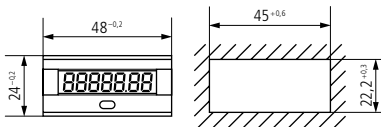

BZ 146

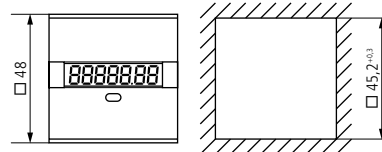

BZ 147

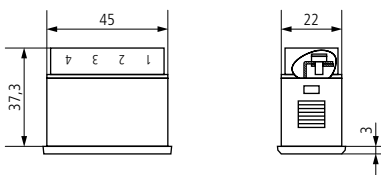

1234h

RAMSES 814 BLE UP

Conveniently controlled from your smartphone



 Bluetooth®



The new RAMSES 814 BLE UP clock thermostat by Theben is the first invisible clock thermostat (heating or cooling). It is completely hidden in the flush-mounted box, under the blind cover or the box lid.

This clock thermostat can be controlled and programmed via an app, is really easy to use and can be quickly adapted to different user prompts. A direct Bluetooth Low Energy (BLE) connection is established between the app and the RAMSES 814 BLE UP. This impresses with its ability to measure and control the temperature accurately while consuming only minimal power. No additional components are necessary, making it an attractively priced product with no hidden costs.



Convenient operation

Fiddly buttons and basic operating displays are a thing of the past. The RAMSES 814 BLE UP is conveniently operated using smartphones and tablets with a high-definition colour touch screen.



Maximum security against tampering













The RAMSES 814 BLE UP only needs a local Bluetooth connection to work in your home. There is no need for an Internet connection or any additional gateways or routers. A clear advantage in terms of security against tampering.



Easy to install

In contrast to other smart thermostats, the RAMSES 814 BLE UP does not need any additional components (gateways, switch actuators, etc.). Install the RAMSES 814 BLE UP just like a conventional clock thermostat: quickly, easily and without fuss. And the best thing of all: with the RAMSES 814 BLE UP, no data is stored in the cloud.



Program	Type of connection	Operating voltage	Switching capacity at 250 V AC	Type of contact	Type	Page
Digital 230 V						
	Weekly program	3-/4-conductors	230 V AC	8 (1) A	Changeover contact	RAMSES 812 BLE 316
		3-/4-conductors	230 V AC	8 (1) A	Changeover contact	RAMSES 814 BLE UP 317
		2-way conductor (BUS) room controller	230 V AC	10 (1) A	Changeover contact	RAMSES 816 BLE 317
		3-/4-conductors	230 V AC	6 (1) A	Changeover contact	RAMSES 812 top2 320 RAMSES 832 top2 320
		DuoFix spring terminals	230 V AC	10 (2) A	Changeover contact	RAMSES 366/1 top2 322
Digital battery version						
	Weekly program	2/3-way conductors	2 AA batteries	6 (1) A	Changeover contact	RAMSES 811 top2 324 RAMSES 831 top2 324
		3-/4-conductors	2 AA batteries	16 (2) A 6 (1) A	NO contact Changeover contact	RAMSES 813 top2 HF Set A 326 RAMSES 813 top2 HF Set 1 326
						RAMSES 833 top2 HF Set 1 328 RAMSES 833 top2 HF Set 2 328
OpenTherm						
	Weekly program	2-way conductor (BUS) room controller	OT-Bus	-	-	RAMSES 850 BLE OT 325
			230 V AC	2 x 2 (1) A Relay, 1 x 1 (1) A Relay	NO contact	RAMSES 816 top2 OT 330
				5 x 5 (1) A Relay, 2 x 1 (1) A Relay	NO contact	RAMSES 856 top2 OT 332
Analogue battery version						
	Daily program	2/3-way conductors	2 AA batteries	6 (1) A	Changeover contact	RAMSES 784 S 334
	Daily/weekly program	2/3-way conductors	2 AA batteries	6 (1) A	Changeover contact	RAMSES 784 334
Analogue 230 V						
	Daily program	3-/4-conductors	230 V AC	6 (1) A	Changeover contact	RAMSES 722 S 336
	Daily/weekly program	3-/4-conductors	230 V AC	6 (1) A	Changeover contact	RAMSES 722 336 RAMSES 782 336
	Daily program	3-/4-conductors	230 V AC	6 (1) A	Changeover contact	RAMSES 721 336
	Daily/weekly program	3-/4-conductors	230 V AC	6 (1) A	Changeover contact	RAMSES 725 336



Climate control

Clock thermostats, Digital 230 V



RAMSES 812 BLE

Description

- Digital clock thermostat for time-dependent monitoring and control of room temperature
- Mains version
- Suitable for energy-saving room temperature control in houses, apartments, etc.
- Operation via app
- Direct Bluetooth Low Energy (BLE) connection between the app and RAMSES BLE, no communication via the Internet
- Settings configured conveniently via the app with intuitive operation from a smartphone or tablet
- Increased user convenience
- External input for the flexible connection of the external room temperature sensor, floor sensor, motion detector or telephone contact
- Intelligent control algorithm (pulse-duration controller, hysteresis controller)
- Suitable for on/off heating systems, zone-based or single-room control, electric heating units

Product selection

Connection type	Program	Setting range temperature	Type	Article number
3-/4-wire	Weekly program	+2 °C to +30 °C	RAMSES 812 BLE	8120150

Technical data

RAMSES 812 BLE			
Operating voltage	230 V AC, 50 Hz	Program	Weekly program
Controller type	Hysteresis or pulse-duration controller	Number of memory locations	42
Switching capacity	8 (1) A/250 V AC	Power reserve	4 hours
Setting range temperature	+2 °C to +30 °C	Type of protection	IP 20
Connection type	3-/4-wire (230 V + switching output)	Protection class	II in accordance with EN 60730-1

Accessories



Temperature sensor RAMSES IP 65
↳ Art.No.: 9070459
Details page 361



Temperature sensor
↳ Art.No.: 9070321
Details page 361

Simple operation via app



- Intuitive programming without the need for prior experience and device monitoring on a high-resolution smartphone display
- Maximum protection against tampering and optimum data protection thanks to the local Bluetooth Low Energy connection. No Internet connection with cloud data storage, remote access and geofencing

Scale drawings

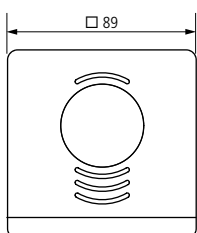



Description

- Digital clock thermostat for time-dependent monitoring and control of room temperature (heating or cooling)
- Mains version
- Operation via app
- Suitable for energy-saving room temperature regulation in houses, apartments, etc.
- Installation in flush-mounted box, can be used with any switching programme or under a blind cover
- Temperature sensor in scope of supply
- Direct Bluetooth Low Energy (BLE) connection between the app and RAMSES BLE, no communication via the Internet
- Settings configured conveniently via the app with intuitive operation from a smartphone or tablet
- Increased user convenience
- External input for the flexible connection of the external room temperature sensor, floor sensor, motion detector or telephone contact
- Intelligent control algorithm (pulse-duration controller, hysteresis controller)
- Suitable for on/off heating systems, zone-based or single-room control, electric heating units

Simple operation via app

- Intuitive programming without the need for prior experience and device monitoring on a high-resolution smartphone display
- Maximum protection against tampering and optimum data protection thanks to the local Bluetooth Low Energy connection. No Internet connection with cloud data storage, remote access and geofencing

Product selection

Programme	Switching capacity at 250 V AC	Temperature setting range	Operating voltage	Type	Item no.
Weekly programme	8 (1) A (with external sensor) 2 (1) A (with temperature sensor in flush-mounted box)	+2 °C ... +30 °C	230 V AC	RAMSES 814 BLE UP	8140150

Technical data

RAMSES 814 BLE UP			
Operating voltage	230 V AC, 50 Hz	Temperature setting range	+2 °C ... +30 °C
Controller type	Hysteresis or pulse-duration controller	Programme	Weekly programme
Switching capacity	8 (1) A/250 V AC (with external sensor)	Number of memory locations	42
	2 (1) A/250 V AC (with temperature sensor in flush-mounted box)	Power reserve	4 years

Accessories



Temperature sensor RAMSES IP 65
↳ Art.No.: 9070459
Details page 361



Temperature sensor
↳ Art.No.: 9070321
Details page 361

Scale drawings

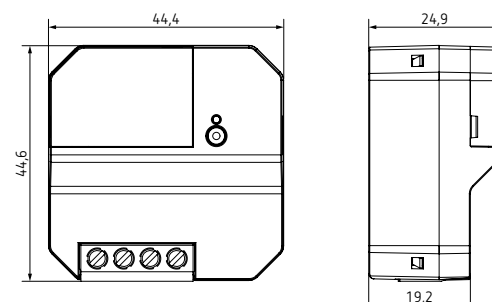

Climate control

Clock thermostats, Digital 230 V



Description

- Digital clock thermostat for time-dependent monitoring and control of room temperature
- Suitable for energy-saving room temperature control in houses, apartments, etc.
- Operation via app
- Direct Bluetooth Low Energy (BLE) connection between the app and RAMSES BLE, no communication via the Internet
- Settings configured conveniently via the app with intuitive operation from a smartphone or tablet
- Increased user convenience
- Power supply via OpenTherm bus (clock thermostat)

RAMSES 816 BLE

- Mains version (control box)
- Relay switch output at the control box (floating, 10 (1) A)
- External input for the flexible connection of the external room temperature sensor, floor sensor, motion detector or telephone contact
- Replaces 2-wire controller in the room when the lower housing is fitted next to the heating
- Suitable for switching higher currents (relay in lower housing) for electric heating units
- Suitable for on/off heating systems, zone-based or single-room control, for higher switching capacities with control box, and for 2-wire connection (for replacing 2-wire battery devices)

RAMSES 816 BLE 2

- Power supply via OpenTherm bus (clock thermostat)
- Mains version (control box)
- Relay switch output at the control box (floating, 5 A) for heating ON/OFF
- Special function for device reset, relay closes briefly for time adjustable in seconds
- Modulation output 0-10 V
- Suitable for heaters with 0-10 V modulation input
- Suitable for heaters with device reset, input or master reset

RAMSES 816 BLE 3

- Power supply via OpenTherm bus (clock thermostat)
- Mains version (control box)
- 1 x relay 10 A floating, 1 x relay 5 A, floating, for heaters with 2-stage regulation
- Hysteresis adjustable between stage 1 and stage 2, (temperature difference between room ACTUAL and room SETPOINT value adjustable from 0.5 °C to 2.5 °C in 0.5 °C steps)
- Heating and cooling function possible
- Heating from 20 °C downwards with relay 1
- Cooling start temperatures (range 20-30 °C)
- Waiting time adjustable for change over between heating and cooling (1-50 h)

Product selection

Program	Setting range temperature	Type	Article number
Weekly program	+2 °C to +30 °C	RAMSES 816 BLE	8160150
		RAMSES 816 BLE 2	8160151
		RAMSES 816 BLE 3	8160152



Technical data

	RAMSES 816 BLE	RAMSES 816 BLE 2	RAMSES 816 BLE 3
Operating voltage	230 V AC OT-Bus		
Frequency	50 Hz		
Switching capacity	10 A (bei 250 V AC, $\cos \varphi = 1$), 1 A (bei 250 V AC, $\cos \varphi = 0,6$)	5 A	1 x 10 A 1 x 5 A
Setting range temperature	+2 °C ... +30 °C		
Program	Weekly program		
Number of memory locations	42		
Power reserve	4 hours		
Type of protection	IP 20		
Protection class	II according to EN 60 730-1		

Accessories



Temperature sensor RAMSES IP 65
↳ Art.No.: 9070459
Details page 361



Temperature sensor
↳ Art.No.: 9070321
Details page 361

Simple operation via app



- Intuitive programming without the need for prior experience and device monitoring on a high-resolution smartphone display
- Maximum protection against tampering and optimum data protection thanks to the local Bluetooth Low Energy connection. No Internet connection with cloud data storage, remote access and geofencing

Connection diagrams

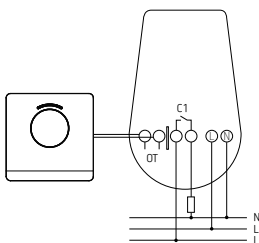

Scale drawings

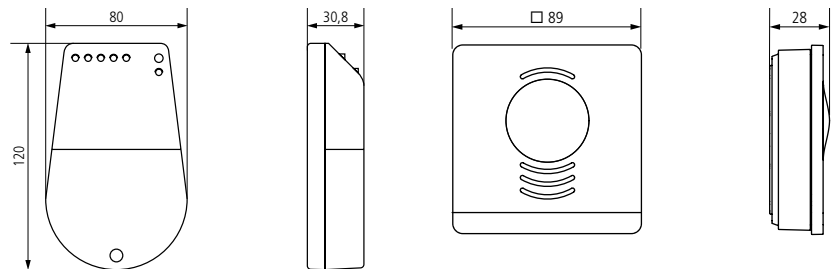

Climate control

Clock thermostats, Digital battery version

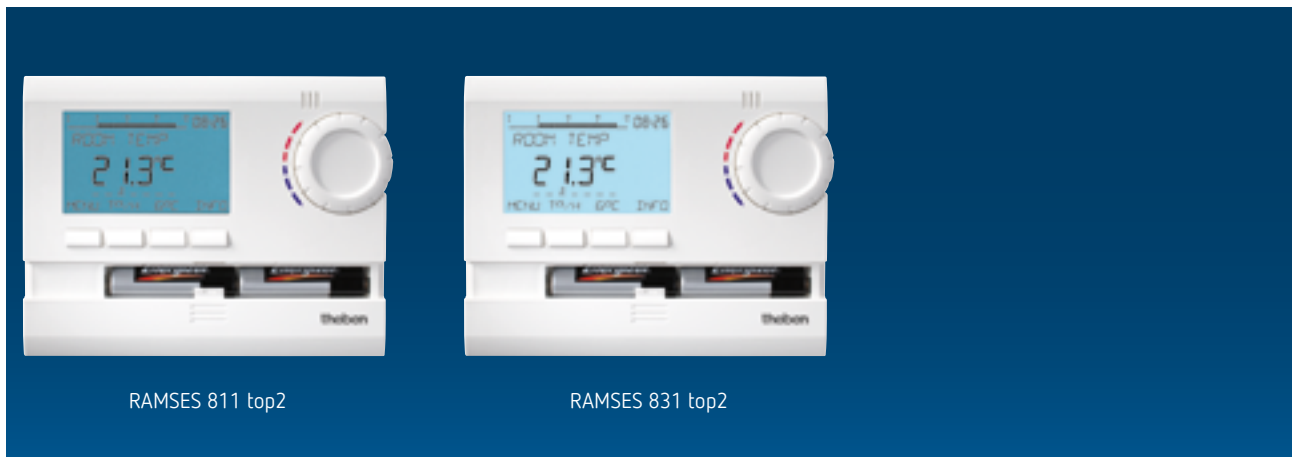

RAMSES 811 top2

RAMSES 831 top2

Description

Common functions

- Digital clock thermostat with a low profile design for time-dependent monitoring and control of room temperature
- Battery version
- Suitable for energy-saving room temperature control in houses, apartments, heating zones, offices, showrooms, factories, medical practices, holiday homes
- Temperature is set quickly via rotary switch
- INFO key for viewing important settings

- Quick start-up via 3 basic programs with individually changeable comfort and reduced temperature
- Party / ECO program
- Fully automatic summer / winter-time correction
- Holiday program with reduction phase or date-controlled heating phase for holiday homes
- Different control types can be individually set
- Optimum start option thanks to operating point and switching differential setting option

- 24 programmable time phases per program also enable reduction phases during the day
- Plug-in base for wall or flush-mounted socket installation

RAMSES 831 top2

- Backlit display through keystroke
- External input for connection of presence detectors, temperature sensors, floor sensors, window contacts or telephone remote switches
- Optimisation function for automatic correction of heating start up

Product selection

Type of connection	Program	Switching capacity at 250 V AC	Setting range temperature	Operating voltage	Type	Article number
2/3-way conductors	Weekly program	6 (1) A	+6 °C ... +30 °C	2 AA batteries	RAMSES 811 top2	8119132
					RAMSES 831 top2	8319132



Technical data

	RAMSES 811 top2	RAMSES 831 top2
Operating voltage	2 AA batteries	
Type of contact	Changeover contact	
Switching capacity	6 A (at 250 V AC, $\cos \varphi = 1$), 1 A (at 250 V AC, $\cos \varphi = 0.6$)	
Setting range temperature	+6 °C ... +30 °C	
Time basis	Quartz	
Program	Weekly program, Daily program, Holiday program, 3 basic programs	
Number of memory locations	42, max. 24 per program	
Control types	Pulse width modulation, Hysteresis controller	
Control period	5–30 min	
Control capture range	0,2–5 K	
Switching output	Potential-free	
Time accuracy at 25 °C	$\leq \pm 1$ s/day (quartz)	
Power reserve	Max. 10 mins without losing time	
Battery life	approx. 1 year, depending on switching frequency	
Type of protection	IP 20	
Protection class	II according to EN 60 730-1	

Accessories



Actuator ALPHA 5 230 V
↳ Art.No.: 9070441
Details page 362



Actuator ALPHA 5 24 V
↳ Art.No.: 9070442
Details page 362



Temperature sensor
for RAMSES 831 top2
↳ Art.No.: 9070321
Details page 361



Temperature sensor RAMSES IP 65
for RAMSES 832 top2
↳ Art.No.: 9070459
Details page 361

Scale drawings

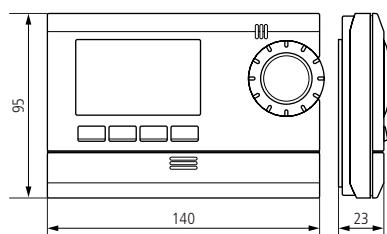

RAMSES 811 top2, RAMSES 831 top2

Connection diagrams

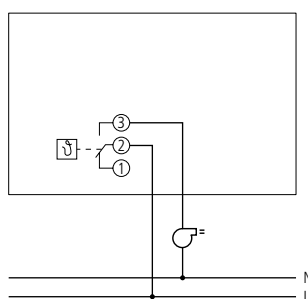

RAMSES 811 top2

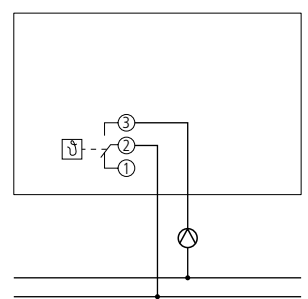

RAMSES 811 top2



Climate control

Clock thermostats, Digital 230 V



RAMSES 812 top2

RAMSES 832 top2

Description

Common functions

- Digital clock thermostat with low profile design for time-dependent monitoring and control of room temperature
- Mains version
- Suitable for energy-saving room temperature control in houses, apartments, heating zones, offices, showrooms, factories, medical practices, holiday homes
- Temperature is set quickly via rotary switch
- INFO key for viewing important settings
- Quick start-up via 3 basic programs with individually changeable comfort and reduced temperature
- Party / ECO program
- Fully automatic summer/winter-time correction
- Different control types can be individually set
- Optimum start option thanks to operating point and switching differential setting option
- 24 programmable time phases per program also enable reduction phases during the day
- Plug-in base for wall or flush-mounted socket installation

RAMSES 832 top2

- Backlit display through keystroke
- External input for connection of presence detectors, temperature sensors, floor sensors, window contacts or telephone remote switches
- Optimisation function for automatic correction of heating start up

Product selection

Type of connection	Program	Switching capacity at 250 V AC	Setting range temperature	Operating voltage	Type	Article number
3-/4-conductors	Weekly program	6 (1) A	+6 °C ... +30 °C	230 V AC	RAMSES 812 top2	8120132
					RAMSES 832 top2	8320132

Technical data

	RAMSES 812 top2	RAMSES 832 top2
Operating voltage	230 V AC	
Frequency	50 Hz	
Type of contact	Changeover contact	
Switching capacity	6 A (at 250 V AC, cos φ = 1), 1 A (at 250 V AC, cos φ = 0.6)	
Setting range temperature	+6 °C ... +30 °C	
Time basis	Quartz	
Program	Weekly program, Daily program, Holiday program, 3 basic programs	
Number of memory locations	42, max. 24 per program	
Control types	Pulse width modulation, Hysteresis controller	
Control period	5–30 min	
Control capture range	0,2–5 K	
Switching output	Potential-free, not for SELV	
Time accuracy at 25 °C	≤ ± 1 s/day (quartz)	
Power reserve	5 hours	

	RAMSES 812 top2	RAMSES 832 top2
Stand-by consumption	0,4 W	
Type of protection	IP 20	
Protection class	II according to EN 60 730-1	

Accessories



Actuator ALPHA 5 230 V
↳ Art.No.: 9070441
Details page 362



Actuator ALPHA 5 24 V
↳ Art.No.: 9070442
Details page 362



Temperature sensor
for RAMSES 832 top2
↳ Art.No.: 9070321
Details page 361



Temperature sensor RAMSES IP 65
for RAMSES 832 top2
↳ Art.No.: 9070459
Details page 361

Scale drawings

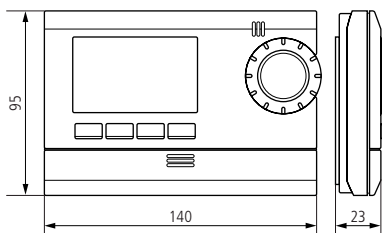

RAMSES 812 top2, RAMSES 832 top2

Connection diagrams

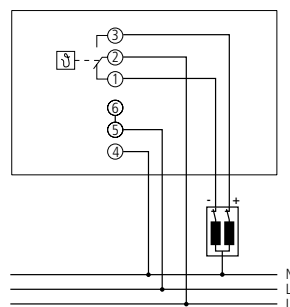

RAMSES 812 top2

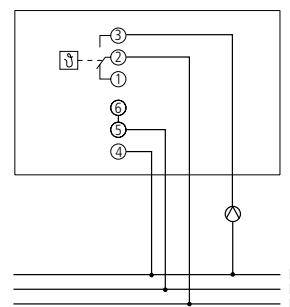

RAMSES 812 top2

Connection diagrams

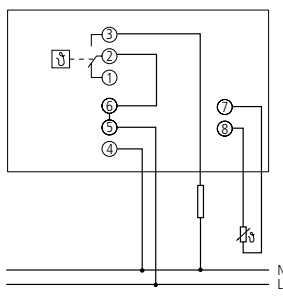

RAMSES 832 top2

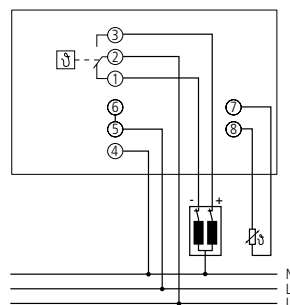

RAMSES 832 top2

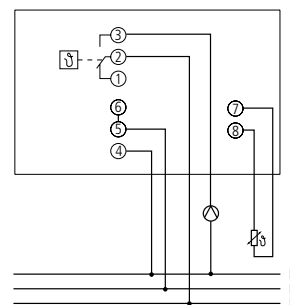

RAMSES 832 top2



Climate control

Clock thermostats, Digital 230 V



RAMSES 366/1 top2

Description

- Digital clock thermostat for time-dependent monitoring and control of room temperature
- Zone control, 1 zone
- 1 external temperature sensor required
- Daily/weekly program can be set to the minute
- Date-controlled holiday program
- Programming displayed graphically by a bar arrangement in the LCD
- Fully automatic summer/winter-time correction
- Manual switching pre-selection and operation mode selector for: Automatic mode, comfort mode, reduction mode, frost protection mode
- PIN coding
- DuoFix spring terminals
- Text-oriented user guidance in display
- Interface for OBELISK top2 memory card (Copying of programs)

Product selection

Number of channels	Program	Switching capacity at 250 V AC	Setting range temperature	Operating voltage	Type	Article number
1	Weekly program	10 (2) A	+6 °C ... +30 °C	230 V AC	RAMSES 366/1 top2	3660100

Technical data

RAMSES 366/1 top2			
Operating voltage	230 V AC	Number of memory locations	42
Frequency	50–60 Hz	Time accuracy at 25 °C	≤ ± 0.25 s/day (quartz)
Type of contact	Changeover contact	Power reserve	10 years
Switching capacity	10 (2) A	Stand-by consumption	1,3 W
Setting range temperature	+6 °C ... +30 °C	Width	2 modules
Time basis	Quartz	Type of protection	IP 20
Program	Weekly program	Protection class	II

Accessories



Actuator ALPHA 5 230 V
↳ Art.No.: 9070441
Details page 362

Actuator ALPHA 5 24 V
Details page 362

Wall mounting kit 35 mm
Details page 352

Memory card OBELISK top2
Details page 353

Front panel kit
Details page 352

External temperature sensor 1
Details page 361

External temperature sensor 2
Details page 361

Connection diagrams

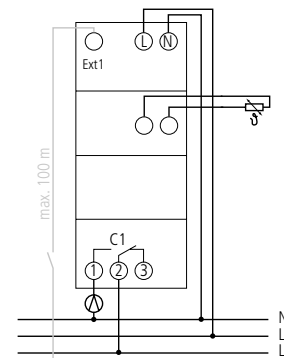

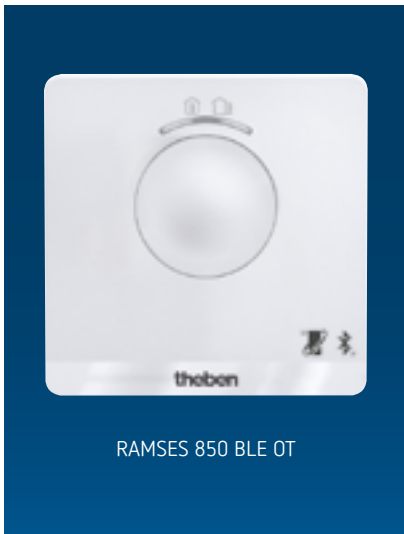

Description

- Digital clock thermostat for time-dependent monitoring and control of room temperature
- Power supply via OpenTherm bus
- Suitable for energy-saving room temperature control in houses, apartments, etc.
- Operation via app
- Direct Bluetooth Low Energy (BLE) connection between the app and RAMSES BLE, no communication via the Internet
- Settings configured conveniently via the app with intuitive operation from a smartphone or tablet
- Increased user convenience
- Communication with the heating unit via OpenTherm
- External input for the flexible connection of the external room temperature sensor, floor sensor, motion detector or telephone contact
- PI room controller, controlled by atmospheric conditions, with or without room influence
- Preset with three modifiable weekly programs for heating and one for tap water
- Suitable for modulating gas condensing boiler systems and modulating heating systems with OpenTherm interface

Product selection

Connection type	Program	Setting range temperature	Type	Article number
2-wire (BUS) room controller	Weekly program	+2 °C to +30 °C	RAMSES 850 BLE OT	8509150

Technical data

RAMSES 850 BLE OT			
Operating voltage	OT bus	Program	Weekly program
Controller type	Modulating controller, works with OpenTherm protocol (OpenTherm V4.0 with SmartPower)	Number of memory locations	42
Setting range temperature	+2 °C to +30 °C	Power reserve	4 hours
Connection type	2-way conductor (BUS) room controller	Type of protection	IP 20
		Protection class	II

Accessories



Temperature sensor RAMSES IP 65
↳ Art.No.: 9070459
Details page 361



Temperature sensor
↳ Art.No.: 9070321
Details page 361

Simple operation via app



- Intuitive programming without the need for prior experience and device monitoring on a high-resolution smartphone display
- Maximum protection against tampering and optimum data protection thanks to the local Bluetooth Low Energy connection. No Internet connection with cloud data storage, remote access and geofencing

Scale drawings

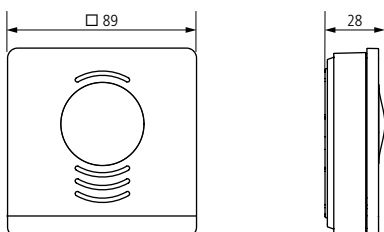

Connection diagrams

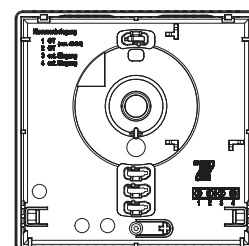

Climate control

Clock thermostats, Digital battery version



RAMSES 813 top2 HF Set A

RAMSES 813 top2 HF Set 1

Description

Common functions

- Radio-controlled system for room temperature control
- The system consists of one digital clock thermostat and one receiver
- Suitable for energy-saving room temperature control in houses, apartments, heating zones, offices, showrooms, factories, medical practices, holiday homes
- Required temperature set via the rotary dial
- INFO key for viewing important settings
- Quick start-up via 3 basic programs with individually changeable comfort and reduced temperature
- Party / ECO program
- Automatic summer/winter time adjustment
- Different control types can be individually set

- Optimum start option thanks to operating point and switching differential setting option
- 24 programmable time phases per program also enable reduction phases during the day
- 2 comfort and 2 reduced temperatures can be allocated to each phase
- Including base for free choice of position
- An optionally available plug-in base is required for wall installation
- Holiday program with reduced temperature or date-controlled heating phase
- Optional pump protection function
- Optional feature to warn when boiler maintenance required

RAMSES 813 top2 HF Set A

- Consisting of a RAMSES 813 top2 HF and a REC 11 receiver with an NO contact 16(2) A/250 V AC for wall mounting

RAMSES 813 top2 HF Set 1

- Consisting of a RAMSES 813 top2 HF and a REC 1 receiver with a two-way switch 6(2) A/250 V AC

Product selection

Type of connection	Program	Switching capacity at 250 V AC	Setting range temperature	Operating voltage	Type	Article number
Radio controlled	Weekly program	16 (2) A	+6 °C ... +30 °C	2 AA batteries	RAMSES 813 top2 HF Set A	8139503
	Weekly program	6 (1) A	+6 °C ... +30 °C	2 AA batteries	RAMSES 813 top2 HF Set 1	8139501



Technical data

	RAMSES 813 top2 HF Set A	RAMSES 813 top2 HF Set 1
Operating voltage	2 AA batteries	
Type of contact	NO contact	Changeover contact
Switching capacity	16 A (at 250 V AC, cos $\phi = 1$), 2 A (at 250 V AC, cos $\phi = 0.6$)	6 A (at 250 V AC, cos $\phi = 1$), 1 A (at 250 V AC, cos $\phi = 0.6$)
Setting range temperature	+6 °C ... +30 °C	
Time basis	Quartz	
Program	Weekly program, Daily program, Holiday program, 3 basic programs	
Number of memory locations	42, max. 24 per program	
Control types	Pulse width modulation, Hysteresis controller	
Control period	5–30 min	
Control capture range	0,2–5 K	
Switching output	Potential-free, not for SELV	Potential-free
Time accuracy at 25 °C	$\leq \pm 1$ s/day (quartz)	
Power reserve	Max. 10 mins without losing time	
Stand-by consumption	1,9 W	1,7 W
Battery life	approx. 1 year, depending on switching frequency	
Width	–	5 modules
Type of protection	IP 20	
Protection class	II according to EN 60 730-1	

Accessories

Socket RAMSES

Details page 360

Actuator ALPHA 5 230 V

Details page 362

Actuator ALPHA 5 24 V

Details page 362

Connection diagrams

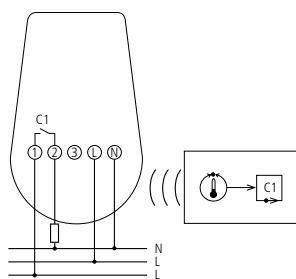

RAMSES 813 top2 HF Set A

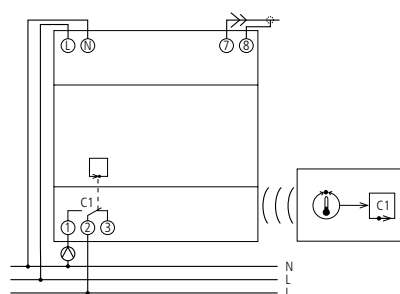

RAMSES 813 top2 HF Set 1

Scale drawings

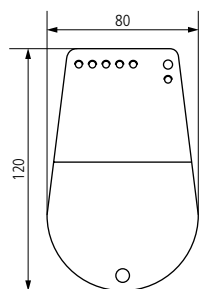

RAMSES 813 top2 HF Set A

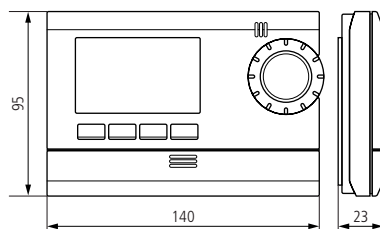
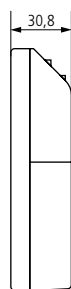

RAMSES 813 top2 HF



Climate control

Clock thermostats, Digital battery version



Description

Common functions

- Radio-controlled system for room temperature control
- Suitable for energy-saving room temperature control in houses, apartments, heating zones, offices, showrooms, factories, medical practices, holiday homes
- The system consists of one or two digital clock thermostat and one receiver
- Required temperature set via the rotary dial
- INFO key for viewing important settings
- Quick start-up via 3 basic programs with individually changeable comfort and reduced temperature
- Party/ECO program
- Automatic summer/winter time adjustment
- Different control types can be individually set

- Optimum start option thanks to operating point and switching differential setting option
- 24 programmable time phases per program also enable reduction phases during the day
- Backlit display through keystroke
- External input for connection of presence detectors, temperature sensors, floor sensors, window contacts or telephone remote switches (can only be used in connection with optional plug-in base for wall mounting)
- Optimisation function for automatic correction of heating start up
- Holiday program with reduction phase or date-controlled heating phase for holiday homes

- Optional feature to warn when boiler maintenance required
- Optional pump protection function
- 3 comfort and 2 reduced temperatures can be allocated to each phase
- Including base for free choice of position
- An optionally available plug-in base is required for wall installation

RAMSES 833 top2 HF Set 1

- Consisting of a RAMSES 833 top2 HF and a REC 1 receiver with a two-way switch 6(2) A/250 VDC

RAMSES 833 top2 HF Set 2

- Consisting of two RAMSES 833 top2 HF and a 2 channel REC 2 receiver with a two-way switch 6(2) A/250 VDC per channel

Product selection

Type of connection	Program	Switching capacity at 250 V AC	Setting range temperature	Operating voltage	Type	Article number
Radio controlled	Weekly program	6 (1) A	+6 °C ... +30 °C	2 AA batteries	RAMSES 833 top2 HF Set 1	8339501
	Weekly program	6 (1) A	+6 °C ... +30 °C	2 AA batteries	RAMSES 833 top2 HF Set 2	8339502



Technical data

	RAMSES 833 top2 HF Set 1	RAMSES 833 top2 HF Set 2
Operating voltage	2 AA batteries	
Type of contact	Changeover contact	
Switching capacity	6 A (at 250 V AC, $\cos \varphi = 1$), 1 A (at 250 V AC, $\cos \varphi = 0.6$)	
Setting range temperature	+6 °C ... +30 °C	
Time basis	Quartz	
Program	Weekly program, Daily program, Holiday program, 3 basic programs	
Number of memory locations	42, max. 24 per program	
Control types	Pulse width modulation, Hysteresis controller	
Control period	5–30 min	
Control capture range	0,2–5 K	
Switching output	Potential-free, not for SELV	
Time accuracy at 25 °C	$\leq \pm 1$ s/day (quartz)	
Power reserve	Max. 10 mins without losing time	
Stand-by consumption	1,7 W	2,2 W
Battery life	approx. 1 year, depending on switching frequency	
Width	5 modules	
Type of protection	IP 20	
Protection class	II according to EN 60 730-1	

Accessories



Actuator ALPHA 5 230 V
↳ Art.No.: 9070441
Details page 362



Temperature sensor
↳ Art.No.: 9070321
Details page 361



Temperature sensor RAMSES IP 65
for RAMSES 833 top2 HF Set 1
↳ Art.No.: 9070459
Details page 361

Socket RAMSES
Details page 360

Actuator ALPHA 5 24 V
Details page 362

Scale drawings

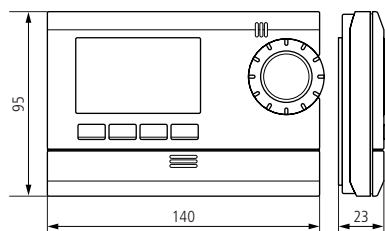

Connection diagrams

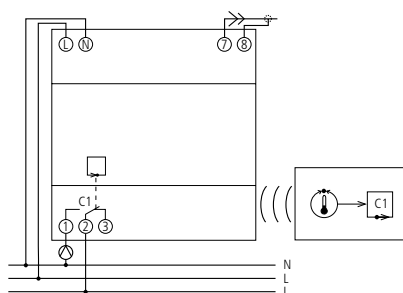

RAMSES 833 top2 HF Set 1

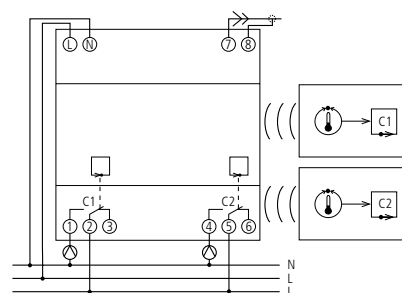

RAMSES 833 top2 HF Set 2



Climate control

Clock thermostats, OpenTherm



Description

- Digital mixer control
- 3 different weekly programs
- 3 comfort and 2 reduced temperatures can be allocated to each zone
- INFO button for the most important data
- Party/ECO program
- Chimney sweeping function with push button OT box
- Minimum boiler temperature can be set
- 2-stage burner control option
- Holiday program with reduced temperature or date-controlled heating phase can be programmed e. g. for holiday homes
- USB interface for modem
- Automatic summer/winter time adjustment
- Control of feed temperature via motorcontrolled mixer
- 3-point controller with feed sensor
- Pump protection function
- Inputs: feed sensor heating circuit (contained in set), external sensor
- Elapsed-time counter for recording relay switching times e.g. burner operating time
- Adjustable reminder function for heater maintenance

Product selection

Type of connection	Program	Switching capacity at 250 V AC	Setting range temperature	Operating voltage	Type	Article number
2-way conductor (BUS) room controller	Weekly program	2 x 2 (1) A, 1 x 1 (1) A	+6 °C ... +30 °C	230 V AC	RAMSES 816 top2 OT	8169132

Technical data

RAMSES 816 top2 OT			
Operating voltage	230 V AC	Number of memory locations	42
Frequency	50 Hz	Switching hysteresis	2–20 K
Type of contact	NO contact	Mixer runtime	2–10 min
Switching capacity	2 x 2 (1) A Relay, 1 x 1 (1) A Relay	Power reserve	4 hours
Setting range temperature	+6 °C ... +30 °C	Stand-by consumption	~1,1 W
Flow temperature limit	+40 °C ... +90 °C	Type of protection	IP 20
Type of connection	2-way conductor (BUS) room controller	Protection class	II according to EN 60 730-1
Program	Weekly program		



Accessories



External temperature sensor
↳ Art.No.: 9070463
Details page 361



Temperature sensor RAMSES IP 65
↳ Art.No.: 9070459
Details page 361



Plunge sensor RAMSES
↳ Art.No.: 9070379
Details page 361

Scale drawings

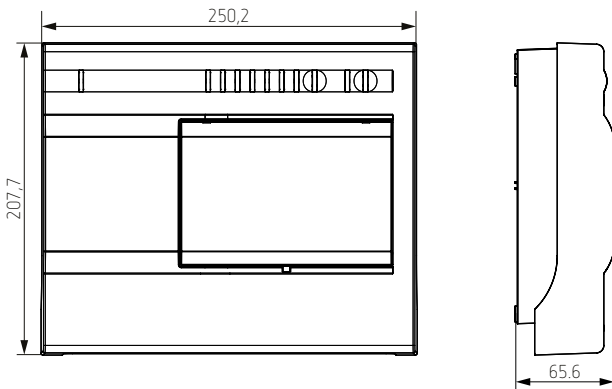

Connection diagrams

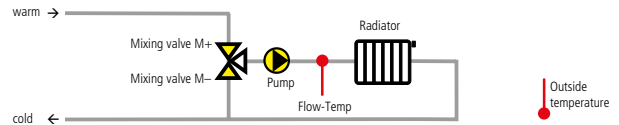
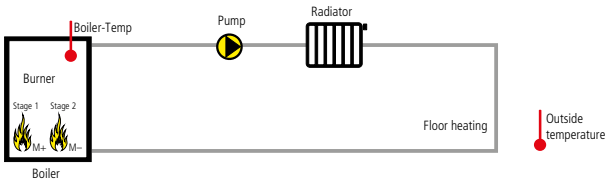

Climate control

Clock thermostats, OpenTherm



Description

- Digital heating control for time-dependent monitoring and control of room temperature
- Open Therm heating controller for 2 or 3 point control, weather-dependent, service water and circulation control
- Automatic sensor recognition for weather- or room-dependent control; can be switched manually at any time
- 3 different weekly programs
- 3 comfort and 2 reduced temperatures can be allocated to each phase
- INFO button for the most important data
- Additional switching program for domestic hot water utilisation times
- Adjustable service water storage temperature, programmable legionella protection
- Party/ECO program
- Chimney sweeping function with push button OT box
- Minimum boiler temperature can be set
- 2 heating curves can be set for 2 heating circuits
- 2-stage burner control option
- Holiday program with reduced temperature or date-controlled heating phase can be programmed e. g. for holiday homes
- USB interface for modem
- Automatic summer/winter time adjustment
- Boiler/feed temperature (control circuit 1) controlled by switching the burner
- Control of feed temperature (control circuit 2) via pump control or motor-controlled mixer
- 3-point controller with feed sensor
- Time- and temperature-dependent control of hot water circulation pump.
- Pump protection function
- Inputs: External sensor (contained in set), feed sensor heating circuit (contained in set), contact or immersion sensor for domestic hot water, contact sensor for circulation
- Elapsed-time counter for recording relay switching times e.g. burner operating time
- Adjustable reminder function for heater maintenance

Product selection

Type of connection	Program	Switching capacity at 250 V AC	Setting range temperature	Operating voltage	Type	Article number
2-way conductor (BUS) room controller	Weekly program	5 x 5 (1), 2 x 1 (1) A	+6 °C ... +30 °C	230 V AC	RAMSES 856 top2 OT	8569132

Technical data

RAMSES 856 top2 OT			
Operating voltage	230 V AC	Number of memory locations	42, max. 24 per program
Frequency	50 Hz	Switching hysteresis	2–20 K
Type of contact	NO contact	Mixer runtime	2–10 min
Switching capacity	5 x 5 (1) A Relay, 2 x 1 (1) A Relay	Power reserve	4 hours
Setting range temperature	+6 °C ... +30 °C	Stand-by consumption	~1,1 W
Flow temperature limit	+40 °C ... +90 °C	Type of protection	IP 20
Type of connection	2-way conductor (BUS) room controller	Protection class	II according to EN 60 730-1
Program	Weekly program		



Accessories



Temperature sensor RAMSES IP 65
↳ Art.No.: 9070459
Details page 361



Flow temperature sensor RAMSES
↳ Art.No.: 9070371
Details page 361



OT-Box Standard
↳ Art.No.: 9070712
Details page 361



Plunge sensor RAMSES
↳ Art.No.: 9070379
Details page 361

Scale drawings

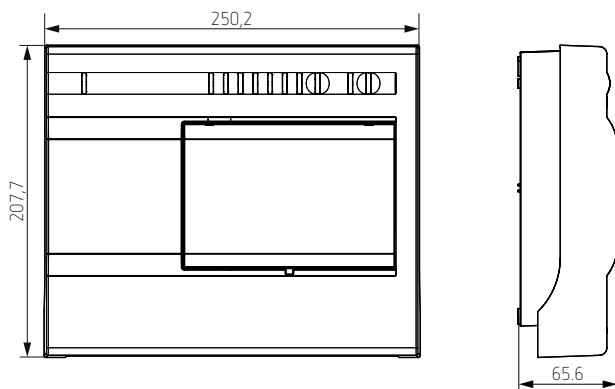

RAMSES 856 top2 OT

Connection diagrams

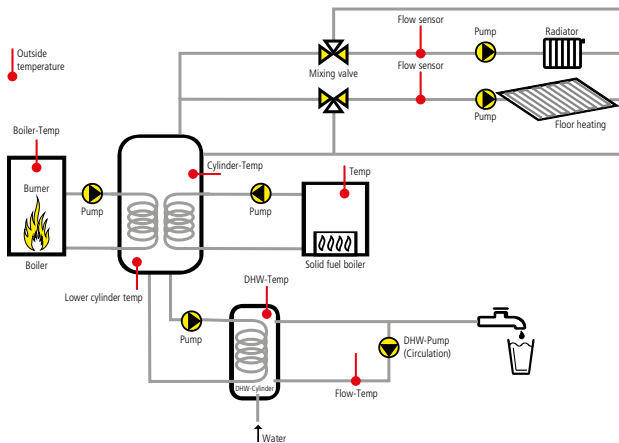

RAMSES 856 top2 OT (in combination with OT-Box 9070712)

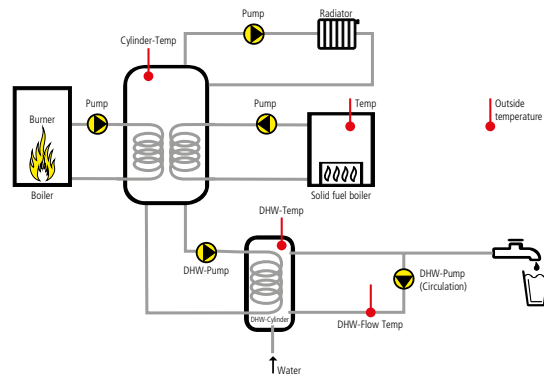

RAMSES 856 top2 OT

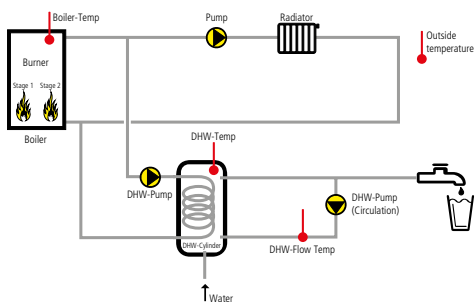

RAMSES 856 top2 OT

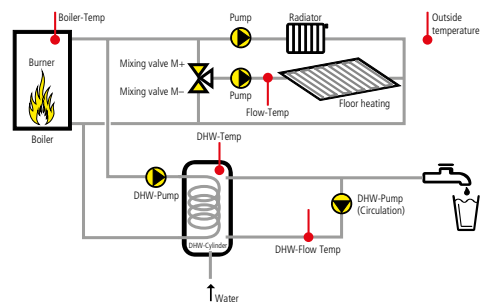

RAMSES 856 top2 OT

Climate control

Clock thermostats, Analogue battery version, Analogue 230 V



RAMSES 784 S

Description

Common functions

- Analogue clock thermostat with a low profile design for time-dependent monitoring and control of room temperature
- Segment program disc with daily program
- Normal and reduced temperature can be set separately
- Operating point and electronic recirculation are set from the front
- Party switch and program display

RAMSES 784 S

- Battery version
- Electronic temperature control
- Quartz mechanism
- Selector switch for operating mode: continuous reduced temperature, continuous normal temperature, automatic mode, frost and plant protection +6 °C
- Battery monitoring with battery replacement indicator via flashing LED

- Silting and pump protection function (option)

RAMSES 722 S

- Mains version
- Synchronous motor drive
- Electronic temperature control
- Selector switch for operating mode: continuous reduced temperature, continuous normal temperature, automatic mode, frost and plant protection +6 °C

Product selection

Power reserve	Type of connection	Program	Type of contact	Setting range temperature	Operating voltage	Type	Article number
-	2/3-way conductors	Daily program	Changeover contact	+10 °C ... +30 °C	2 AA batteries	RAMSES 784 S	7840801
-	3-/4-conductors	Daily program	Changeover contact	+10 °C ... +30 °C	230 V AC	RAMSES 722 S	7220801



Climate control

Clock thermostats, Analogue battery version, Analogue 230 V

Technical data

	RAMSES 784 S	RAMSES 722 S
Operating voltage	2 AA batteries	230 V AC
Frequency	–	50 Hz
Type of contact	Changeover contact	
Program	Daily program	
Switching capacity	6 A (at 250 V AC, $\cos \varphi = 1$), 1 A (at 250 V AC, $\cos \varphi = 0.6$)	
Switching differential	0,4–1,2 K	
Switching output	Potential-free	Potential-free, not for SELV
Setting range temperature	+10 °C ... +30 °C	
Shortest switching times	15 min	
Programmable every	15 min	
Time accuracy at 25 °C	$\leq \pm 1$ s/day (quartz)	Synchronised with mains
Stand-by consumption	–	1,3 W
Battery life	approx. 1 year, depending on switching frequency	–
Type of protection	IP 20	
Protection class	II according to EN 60 730-1	

Accessories



Actuator ALPHA 5 230 V

↳ Art.No.: 9070441

Details page 362

Actuator ALPHA 5 24 V

Details page 362

Adapter RAMSES 72x/78x

Details page 360

Scale drawings

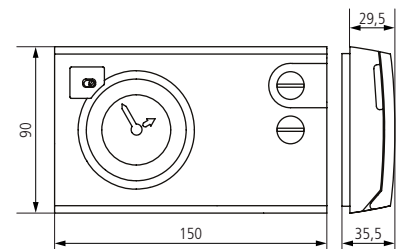

Connection diagrams

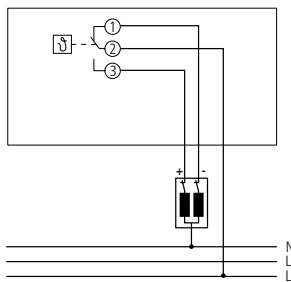

RAMSES 784 S

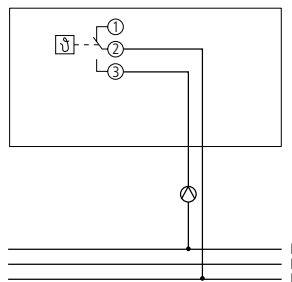

RAMSES 784 S

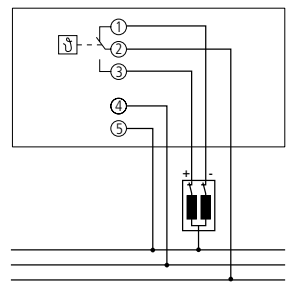

RAMSES 722 S

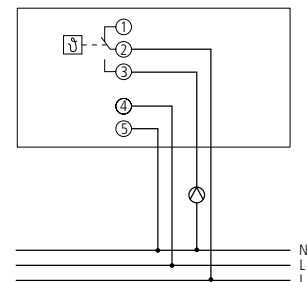

RAMSES 722 S



Climate control

Clock thermostats, Analogue battery version, Analogue 230 V



Description

Common functions

- Analogue clock thermostat with a low profile design for time-dependent monitoring and control of room temperature
- Operating point and electronic recirculation are set from the front
- Party switch and program display

RAMSES 784

- Battery version
- Tappet program disc with daily or weekly program
- Electronic temperature control
- Normal and reduced temperature can be set separately
- Quartz mechanism
- Selector switch for operating mode: continuous reduced temperature, continuous normal temperature, automatic mode, frost and plant protection +6 °C
- Battery monitoring with battery replacement indicator via flashing LED
- Silting and pump protection function (option)

RAMSES 722

- Mains version

- Tappet program disc with daily or weekly program
- Synchronous motor drive
- Normal and reduced temperature can be set separately
- Electronic temperature control
- Selector switch for operating mode: continuous reduced temperature, continuous normal temperature, automatic mode, frost and plant protection +6 °C

RAMSES 782

- Mains version
- Tappet program disc with daily or weekly program
- Quartz mechanism, 3 day power reserve
- Normal and reduced temperature can be set separately
- Electronic temperature control
- Selector switch for operating mode: continuous reduced temperature, continuous normal temperature, automatic mode, frost and plant protection +6 °C

RAMSES 721

- Mains version
- Tappet program disc with daily program

- Synchronous motor drive
- Normal temperature can be set
- Reduced temperature approx. 5 K lower in relation to the set comfort temperature
- Without selector switch
- Electronic temperature control
- Selector switch for operating mode: continuous reduced temperature, continuous normal temperature, automatic mode, frost and plant protection +6 °C

RAMSES 725

- Mains version
- Tappet program disc with daily or weekly program
- Synchronous motor drive
- Reduced temperature can be set
- Central control of reduced temperature as per time program
- Electronic temperature control
- Selector switch for operating mode: continuous reduced temperature, continuous normal temperature, automatic mode, frost and plant protection +6 °C

Product selection

Power reserve	Type of connection	Program	Type of contact	Setting range temperature	Operating voltage	Type	Article number
-	2/3-way conductors	Daily/weekly program	Changeover contact	+10 °C ... +30 °C	2 AA batteries	RAMSES 784	7840030
	3-/4-conductors	Daily/weekly program	Changeover contact	+10 °C ... +30 °C	230 V AC	RAMSES 722	7220030
3 days	3-/4-conductors	Daily/weekly program	Changeover contact	+10 °C ... +30 °C	230 V AC	RAMSES 782	7820030
-	3-/4-conductors	Daily program	Changeover contact	+10 °C ... +30 °C	230 V AC	RAMSES 721	7210030
		Daily/weekly program	Changeover contact	+10 °C ... +30 °C	230 V AC	RAMSES 725	7250030

Climate control

Clock thermostats, Analogue battery version, Analogue 230 V

Technical data

	RAMSES 784	RAMSES 722	RAMSES 782	RAMSES 721	RAMSES 725
Operating voltage	2 AA batteries	230 V AC			
Frequency	–	50 Hz	50–60 Hz	50 Hz	
Type of contact	Changeover contact				
Program	Daily/weekly program			Daily program	Daily/weekly program
Switching capacity	6 A (at 250 V AC, $\cos \varphi = 1$), 1 A (at 250 V AC, $\cos \varphi = 0.6$)				
Switching differential	0,4–1,2 K			1,5 K	
Switching output	Potential-free	Potential-free, not for SELV			
Setting range temperature	+10 °C ... +30 °C				
Shortest switching times	20 min, 120 min			20 min	20 min, 120 min
Programmable every	5 min, 30 min			5 min	5 min, 30 min
Time accuracy at 25 °C	$\leq \pm 1$ s/day (quartz)	Synchronised with mains	$\leq \pm 1$ s/day (quartz)	Synchronised with mains	
Power reserve	–	–	3 days	–	
Stand-by consumption	–	~1,3 W	1,1 W	1,3 W	1,4 W
Battery life	approx. 1 year, depending on switching frequency		–		
Type of protection	IP 20				
Protection class	II according to EN 60 730-1				

Accessories



Actuator ALPHA 5 230 V

↳ Art.No.: 9070441

Details page 362

Actuator ALPHA 5 24 V

Details page 362

Adapter RAMSES 72x/78x

Details page 360

Scale drawings

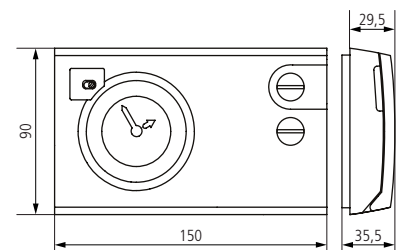

Connection diagrams

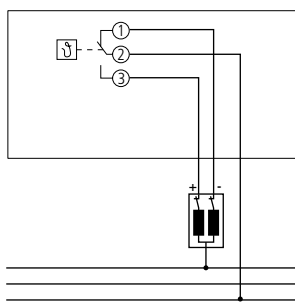

RAMSES 784

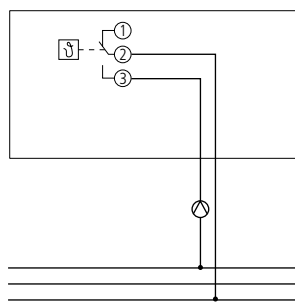

RAMSES 784

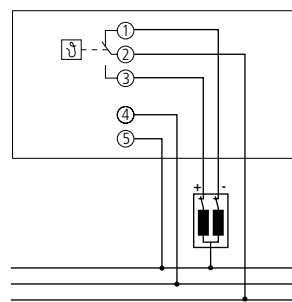

RAMSES 722, RAMSES 782,
RAMSES 721, RAMSES 725

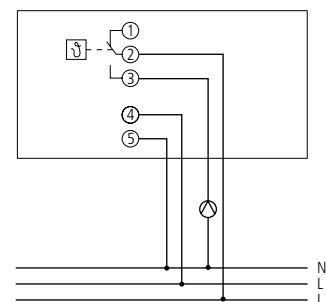

RAMSES 722, RAMSES 782,
RAMSES 721, RAMSES 725



AMUN 716 CO₂ Monitor

Get your ventilation right



Lots of people sharing a room can quickly produce poor air quality. This is mostly caused by exhaled carbon dioxide (CO₂). In turn, this lowers well-being, concentration and performance.

The classification system used by the German Environment Agency for inhaled air quality

CO ₂ content in the room	Hygiene assessment	Recommendations
< 1000 ppm	Hygienically acceptable	No further measures required
1000 to 2000 ppm	Serious cause for concern	Ventilation measures, check and improve ventilation habits
> 2000 ppm	Hygienically unacceptable	Check that the room can be properly ventilated; implement further measures if applicable



The reliable way to measure CO₂ concentration levels

Theben CO₂ sensors monitor CO₂ concentration levels in schools and classrooms, in offices and meeting rooms or in passive and low-energy buildings. CO₂ sensors thereby make a decisive contribution to room air quality.



Mobile CO₂ sensor with USB cable for measuring air quality



Suitable for schools/nurseries, offices, conference and meeting rooms, and rooms in homes



In the event of a potentially dangerous CO₂ concentration, the device gives a visual warning via the LED traffic light indicator so that the ventilation can be optimised to create a healthy room climate.



A compact solution to improve air quality: thePrema P360 KNX AP Multi WH presence detector with CO₂ sensor



Integrated CO₂ sensor!

For technical details, see the KNX section on page 88.

With its integrated CO₂ sensor, the thePrema P360 KNX Multi presence detector from Theben not only detects the presence of people, but also the CO₂ concentration in the room. Good room air quality and regular ventilation of enclosed spaces are more important than ever at the moment. In offices and classrooms in particular, constant measurement of the CO₂ concentration means that rooms can be ventilated in a targeted manner in order to minimise harmful aerosols and improve the air quality.

This is where the thePrema P360 KNX Multi from Theben comes in: the device combines a presence detector and a CO₂ sensor in one compact housing. People in the room are reliably detected and, at the same time, the CO₂ concentration is measured precisely. The ventilation is controlled efficiently via the KNX building automation system on the basis of easily configurable threshold values.



KNX multisensor



Consisting of KNX passive infrared presence detector and KNX room air sensor KNX (= 2 bus sharing units)



Measures CO₂ concentration, relative humidity, temperature and air pressure

Easy installation and integration into the KNX building automation system

As multiple devices are combined in one housing, there is only one unit to install. This reduces the amount of effort involved in installation considerably. In addition to its presence detection and CO₂ level functions, the unit also measures the relative humidity, temperature and barometric air pressure.

This allows further actions of the KNX-based building control system to be triggered with a single unit. Practical: Existing thePrema KNX presence detectors can be upgraded easily and cost-effectively.

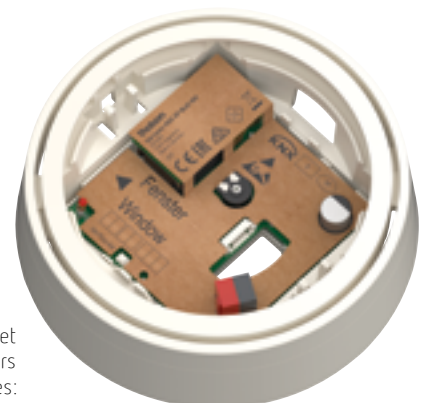



KNX AP Multi WH basic set
for retrofitting into existing KNX detectors
of the following types:
thePrema S/P KNX UP WH



Description	Type	Page
-------------	------	------

CO₂ sensors



	CO ₂ sensor with USB cable	AMUN 716 CO2 Monitor	342
	CO ₂ sensor for ventilation control and monitoring of air quality in the room with switch and analog outputs	AMUN 716 SR	344

Hygrostat



	Hygrostat for wall installation for control of humidifiers or ventilation and dehumidifier systems	SOTHIS 715	345
---	--	------------	-----

Type of connection	Switching capacity at 230 V AC	Type of contact	Operating voltage	Installation type	Type	Page
--------------------	--------------------------------	-----------------	-------------------	-------------------	------	------

Mechanical

	2/3-way conductors	10 (4) A	NC contact	230–240 V AC	Surface-mounted	RAMSES 701	346
	3-/4-conductors	10 (4) A	NC contact	230–240 V AC	Surface-mounted	RAMSES 702	346
						RAMSES 703	346
						RAMSES 704	346
						RAMSES 705	346
	4/5-way conductor	10 (4) A	NC contact	230–240 V AC	Surface-mounted	RAMSES 706	346
						RAMSES 707	346
	3-/4-conductors	Heating: 10 (4) A Cooling: 5 (2) A	Changeover contact	230–240 V AC	Surface-mounted	RAMSES 708	346
	4/5-way conductor	Heating: 10 (4) A Cooling: 5 (2) A	Changeover contact	230–240 V AC	Surface-mounted	RAMSES 709	346
	2/3-way conductors	10 (4) A	NC contact	230–240 V AC	Flush-mounted	RAMSES 741	348
	4/5-way conductor	10 (4) A	NC contact	230–240 V AC	Flush-mounted	RAMSES 746	348
	3-/4-conductors	Heating: 10 (4) A Cooling: 5 (1) A	Changeover contact	230–240 V AC	Flush-mounted	RAMSES 748	348
	2/3-way conductors	10 (4) A	NC contact	230–240 V AC	Flush-mounted	RAMSES 741 RA	348
	4/5-way conductor	10 (4) A	NC contact	230–240 V AC	Flush-mounted	RAMSES 746 RA	348
	3-/4-conductors	Heating: 10 (4) A Cooling: 5 (1) A	Changeover contact	230–240 V AC	Flush-mounted	RAMSES 748 RA	348

Electronic

	2/3-way conductors	8 A (at 230 V AC, cos φ = 1)	NC contact	230 V AC	Surface-mounted	RAMSES 714	350
	4/5-way conductor	16 A (at 230 V AC, cos φ = 1)	NC contact	230 V AC	Surface-mounted	RAMSES 714 A	350
	5-way conductor	16 (4) A	NO contact	230 V AC	Flush-mounted	RAMSES 751 RA	350



Climate control

CO₂ sensors



Description

- Mobile CO₂ sensor with USB cable for measuring air quality
- Suitable for schools/nurseries, offices, conference or meeting rooms and living spaces
- The device warns optically via the LED traffic light system in case of a potentially dangerous CO₂ concentration - so ventilation can be optimized immediately and a healthy room climate can be created
- Green threshold value: Up to 1,000 ppm CO₂, hygienically ok, everything is in the green range!
- Threshold value orange: Up to 2,000 ppm CO₂, hygienically noticeable, Aeration - good idea!
- Threshold value red: Over 2,000 ppm CO₂, hygienically unacceptable, Ventilation is an absolute must!
- Fresh air must be supplied and the used air removed at latest when the red threshold value is reached
- Includes USB cable for easy setup
- Stand and non-slip pad included, alternative wall mounting is also possible
- Development based on the recommendation for CO₂ in indoor air of the Federal Environment Agency according to various guidelines, e.g. the Bavarian „Guideline for the Promotion of Investment Costs for Technical Measures for Infection-Protection-Compatible Ventilation in Schools (FILS-R)

Product selection

Display	Operating voltage	Type	Article number
LED	USB	AMUN 716 CO ₂ Monitor	7169100

Technical data

AMUN 716 CO ₂ Monitor			
Operating voltage	5 V DC via USB bus voltage	Display	6 LEDs
Measuring range CO ₂	0–5000 ppm	Installation type	Stand and non-slip pad included, alternative wall mounting is also possible
Accuracy	0-1000 ppm: ± (50 ppm + 3% from the measured value)	Type of protection	IP 20
	1001-2000 ppm: ± (50 ppm + 5% from the measured value)	Protection class	III
	> 2000 ppm: ± (100 ppm + 5% from the measured value)	Length usb cable	1,5 m

Scale drawings

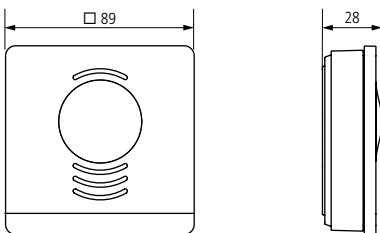

Application images



Climate control

CO₂ sensors



Description

- CO₂ sensor
- Suitable for conference and meeting rooms, offices, schools/nurseries, passive and low-energy housing.
- For fan control
- Warning display for CO₂ concentration (lights)
- Power unit optionally available. Power unit is suitable for flush mounted installation
- Simple upgrade of uncontrolled ventilation systems possible
- 2 switch outputs CO₂ controlled for 2 stage control, with manual and automatic mode as well as display of switching status
- 3 x 0–10 V outputs for CO₂, temperature and relative humidity

Product selection

Measuring range	Data interface	Display	Operating voltage	Protection class	Type	Article number
Selectable: 0–5000 ppm/0–5000 ppm	3 x 0-10 V, 2 x relay 5 A/250 V AC	LEDs	24 V AC/DC	II according to EN 60 730-1	AMUN 716 SR	7160110

Technical data

AMUN 716 SR			
Operating voltage	24 V AC/DC SELV	Type of connection	Screw terminals
Outputs	3 x 0-10 V, 2 x relay 5 A/250 V AC	Display	6 LEDs
Measuring range CO ₂	Selectable: 0–5000 ppm or 0–5000 ppm	Installation type	Wall installation (also on flush-mounted socket possible)
Measuring range temperature	+5 °C ... +40 °C	Type of protection	IP 20
Measuring range humidity	30–80 % rH	Protection class	II according to EN 60 730-1
ON/OFF thresholds	700 ppm ±200 ppm, 1300 ppm ±200 ppm		

Accessori



Power unit CO₂-sensor

↳ Art.No.: 9070494

Details page 363

Dimensioni

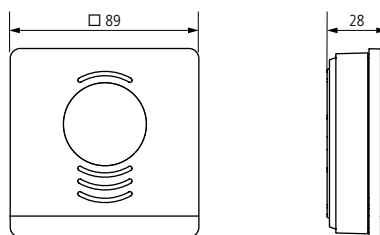

AMUN 716 SR





Description

- Hygrostat for wall installation
- Measurement of relative humidity
- Suitable for control of humidifiers or ventilation and dehumidifier systems
- Use SELV when there is a risk of high humidity and the build up of condensation

Product selection

Measuring range	Type of contact	Switching capacity humidifier	Switching capacity dehumidifying	Type	Article number
35–100 % rH	Changeover contact	2 A	5 A	SOTHIS 715	7150002

Technical data

SOTHIS 715			
Switching capacity dehumidifying	5 A	Installation type	Wall installation
Switching capacity humidifier	2 A	Type of protection	IP 30
Suitable for SELV	Yes	Protection class	II according to EN 60 730-1
Colour	Pure white (similar to RAL 9010)		

Accessories



Adapter plate RAMSES 714

↳ Art.No.: 9070212

Details page 360

Scale drawings

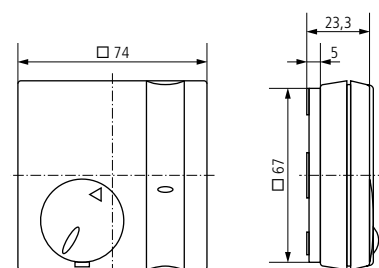

SOTHIS 715

Connection diagrams

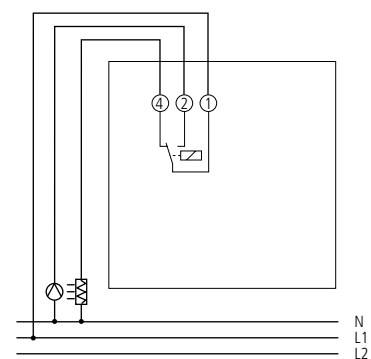

SOTHIS 715



Climate control

Room thermostats, Mechanical



Description

Common functions

- Room temperature controller with thermal feedback
- Suitable for all types of heating, e.g. gas, water, electric heating with central/individual room control
- Setting controller with mechanical setting limit or detection

RAMSES 702

- Integrated temperature reduction (approx. 4 K) possible via control with time switch

RAMSES 703

- Internal setting: Temperature cannot be set externally. Temperature is set inside the device at start-up

- Integrated temperature reduction (approx. 4 K) possible via control with time switch

RAMSES 704

- Switch for additional heating ON/OFF + indicator lamp

RAMSES 705

- Switch for heating ON/OFF

RAMSES 706

- Switch for heating ON/OFF + indicator lamp
- Integrated temperature reduction (approx. 4 K) possible via control with time switch

RAMSES 707

- Switch for heating ON/OFF

- Switch for additional heating ON/OFF + indicator lamp

RAMSES 708

- Also suitable for air conditioning equipment
- Heating/cooling changeover contact

RAMSES 709

- Also suitable for air conditioning equipment
- Heating/cooling changeover contact
- 3-way selector switch for: comfort mode, reduction mode, external reduction
- Indicator lamp
- External temperature reduction (approx. 4 K) possible via control with time switch

Product selection

Type of connection	Type of contact	Switching capacity at 230 V AC	Setting range temperature	Operating voltage	Type	Article number
2/3-way conductors	NC contact	10 (4) A	+5 °C ... +30 °C	230–240 V AC	RAMSES 701	7010001
3-/4-conductors	NC contact	10 (4) A	+5 °C ... +30 °C	230–240 V AC	RAMSES 702	7020001
					RAMSES 703	7030001
					RAMSES 704	7040001
					RAMSES 705	7050001
4/5-way conductor	NC contact	10 (4) A	+5 °C ... +30 °C	230–240 V AC	RAMSES 706	7060001
					RAMSES 707	7070001
3-/4-conductors	Changeover contact	Heating: 10 (4) A Cooling: 5 (2) A	+5 °C ... +30 °C	230–240 V AC	RAMSES 708	7080001
4/5-way conductor	Changeover contact	Heating: 10 (4) A Cooling: 5 (2) A	+5 °C ... +30 °C	230–240 V AC	RAMSES 709	7090001



Technical data

	RAMSES 701 – RAMSES 707	RAMSES 708 – RAMSES 709
Operating voltage	230–240 V AC	
Frequency	50–60 Hz	
Type of contact	NC contact	Changeover contact
Switching capacity	10 A (at 230 V AC, $\cos \varphi = 1$), 4 A (at 230 V AC, $\cos \varphi = 0.6$)	Heating: 10 A (at 230 V AC, $\cos \varphi = 1$), 4 A (at 230 V AC, $\cos \varphi = 0.6$) Cooling: 5 A (at 230 V AC, $\cos \varphi = 1$), 2 A (at 230 V AC, $\cos \varphi = 0.6$)
Setting range temperature	+5 °C ... +30 °C	
Control accuracy	Approx. 1 K, thermal recirculation	
Colour	Pure white (similar to RAL 9010)	
Installation type	Surface-mounted	
Type of protection	IP 30	
Protection class	II according to EN 60 730-1	

Accessories



Actuator ALPHA 5 230 V
↳ Art.No.: 9070441
Details page 362



Adapter plate RAMSES 70x
↳ Art.No.: 9070480
Details page 360

Scale drawings

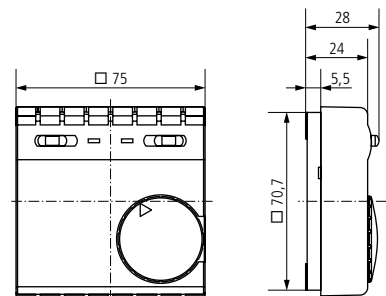

Connection diagrams

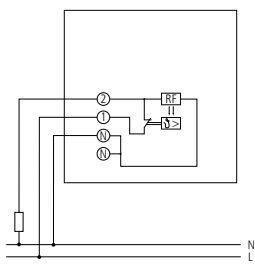

RAMSES 701

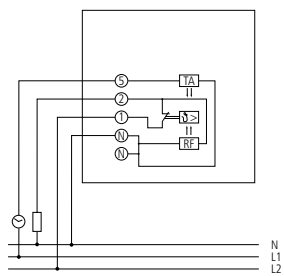

RAMSES 702, RAMSES 703

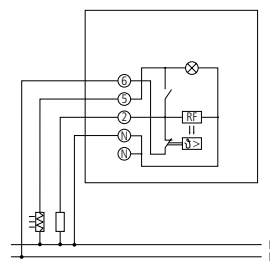

RAMSES 704

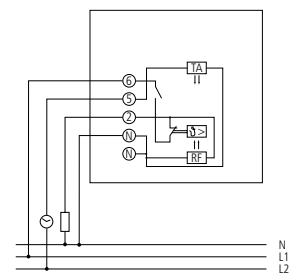

RAMSES 705

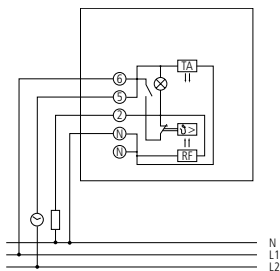

RAMSES 706

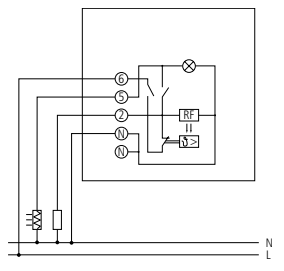

RAMSES 707

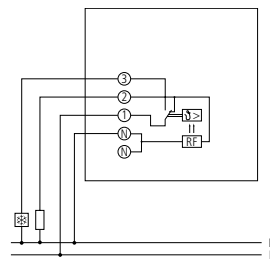

RAMSES 708

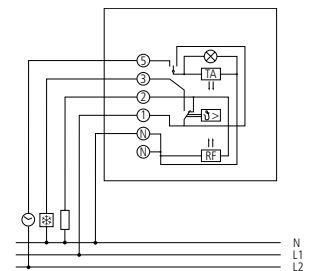

RAMSES 709



Climate control

Room thermostats, Mechanical



Description

Common functions

- Room temperature controller with thermal feedback
- Central part fits nearly all frames using an adapter frame from the switch manufacturer
- Ideal controller for refurbished and new build properties

RAMSES 741

- Supplied as replacement device without frame, central part and setting button
- Frame, central part and setting button available as accessories

RAMSES 746

- Switch for heating ON/OFF + indicator lamp
- Supplied as replacement device without frame, central part and setting button
- Frame, central part and setting button available as accessories

RAMSES 748

- Heating/cooling two-way switch
- Supplied as replacement device without frame, central part and setting button
- Frame, central part and setting button available as accessories

RAMSES 741 RA

- With frame, central part and setting button

RAMSES 746 RA

- With frame, central part and setting button
- Switch for heating ON/OFF + indicator lamp

RAMSES 748 RA

- Heating/cooling two-way switch
- With frame, central part and setting button

Product selection

Scope of delivery	Type of connection	Type of contact	Switching capacity at 230 V AC	Setting range temperature	Operating voltage	Type	Article number
Without cover	2/3-way conductors	NC contact	10 (4) A	+5 °C ... +30 °C	230–240 V AC	RAMSES 741	7410130
	4/5-way conductor	NC contact	10 (4) A	+5 °C ... +30 °C	230–240 V AC	RAMSES 746	7460130
	3-/4-conductors	Changeover contact	Heating: 10 (4) A Cooling: 5 (1) A	+5 °C ... +30 °C	230–240 V AC	RAMSES 748	7480130
With cover	2/3-way conductors	NC contact	10 (4) A	+5 °C ... +30 °C	230–240 V AC	RAMSES 741 RA	7410131
	4/5-way conductor	NC contact	10 (4) A	+5 °C ... +30 °C	230–240 V AC	RAMSES 746 RA	7460131
	3-/4-conductors	Changeover contact	Heating: 10 (4) A Cooling: 5 (1) A	+5 °C ... +30 °C	230–240 V AC	RAMSES 748 RA	7480131



Technical data

	RAMSES 741/746	RAMSES 748	RAMSES 741/746 RA	RAMSES 748 RA
Operating voltage	230–240 V AC			
Frequency	50–60 Hz			
Type of contact	NC contact	Changeover contact	NC contact	Changeover contact
Switching capacity	10 A (at 230 V AC, cos $\varphi = 1$), 4 A (at 230 V AC, cos $\varphi = 0.6$)	Heating: 10 A (at 230 V AC, cos $\varphi = 1$), 4 A (at 230 V AC, cos $\varphi = 0.6$) Cooling: 5 A (at 230 V AC, cos $\varphi = 1$), 1 A (at 230 V AC, cos $\varphi = 0.6$)	10 A (at 230 V AC, cos $\varphi = 1$), 4 A (at 230 V AC, cos $\varphi = 0.6$)	Heating: 10 A (at 230 V AC, cos $\varphi = 1$), 4 A (at 230 V AC, cos $\varphi = 0.6$) Cooling: 5 A (at 230 V AC, cos $\varphi = 1$), 1 A (at 230 V AC, cos $\varphi = 0.6$)
Setting range	+5 °C ... +30 °C			
Control accuracy	approx. 0.5 K, thermal recirculation			
Colour	–		Brilliant pure white (similar to RAL 9010)	
Installation type	Flush-mounted			
Type of protection	–		IP 30	
Protection class	II according to EN 60 730-1			

Accessories



Actuator ALPHA 5 230 V
↳ Art.No.: 9070441
Details page 362

Central part RAMSES 746
Details page 362

Central part RAMSES 741/748
Details page 362

Frame RAMSES 74x
Details page 360

Scale drawings

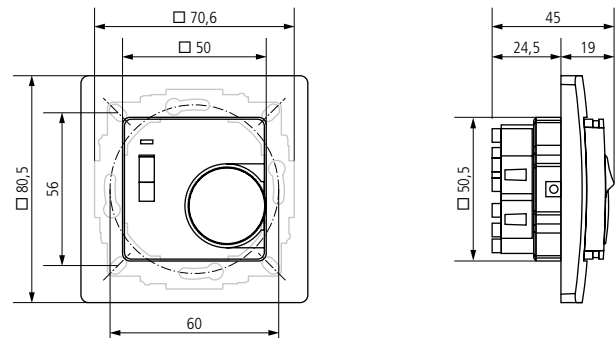

Connection diagrams

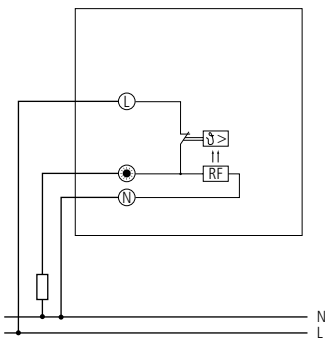

RAMSES 741, RAMSES 741 RA

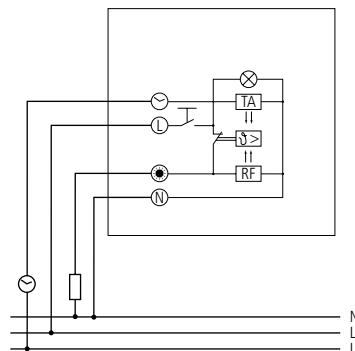

RAMSES 746, RAMSES 746 RA

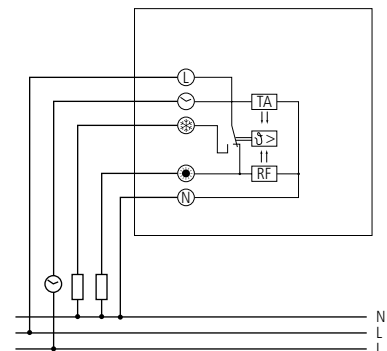

RAMSES 748, RAMSES 748 RA



Climate control

Room thermostats, Electronic



Description

RAMSES 714

- Electronic room thermostats for all types of heating, e.g. gas, water, electric heating etc.
- Individual room control possible in combination with Theben actuators
- Heating status display via LED
- External temperature reduction (approx. 3.5 K) is possible via control with time switch. Temperature reduction can be cut to 2 K by opening a wire bridge

RAMSES 714 A

As RAMSES 714, but:

- External temperature sensor for underfloor heating (wet rooms or bathroom heating)
- Switchable for the connection of available NTC sensors (33 K Ω /25 °C)
- Switch for heating ON/OFF

RAMSES 751 RA

- Electronic room thermostat with remote temperature sensor for underfloor heating control

- Display of temperature reduction and heating ON
- 2-pole mains switch for heating ON/OFF
- Emergency mode for sensor malfunction at 30 % heating
- Central part fits nearly all frames using an adapter frame from the switch manufacturer

Product selection

Type of connection	Type of contact	Switching capacity at 230 V AC	Setting range temperature	Installation type	Type	Article number
2/3-way conductors	NC contact	8 A (at 230 V AC, cos φ = 1)	+5 °C ... +30 °C	Surface-mounted	RAMSES 714	7140002
4/5-way conductor	NC contact	16 A (at 230 V AC, cos φ = 1)	+10 °C ... +60 °C	Surface-mounted	RAMSES 714 A	7140016
5-way conductor	NO contact	16 (4) A	+10 °C ... +50 °C	Flush-mounted	RAMSES 751 RA	7510131

Technical data

	RAMSES 714	RAMSES 714 A	RAMSES 751 RA
Operating voltage	230 V AC		
Frequency	50 Hz		
Type of contact	NC contact		NO contact
Switching output	Not potential-free		Potential-free
Switching capacity	8 A (at 230 V AC, cos φ = 1)	16 A (at 230 V AC, cos φ = 1)	16 A (at 230 V AC, cos φ = 1), 4 A (at 230 V AC, cos φ = 0.6)
Setting range temperature	+5 °C ... +30 °C	+10 °C ... +60 °C	+10 °C ... +50 °C
Control accuracy	\pm 0.25 K	\pm 0.5 K	
Control behaviour	-		Proportional controller with PWM (continuous type)
Colour	Pure white (similar to RAL 9010)		
Installation type	Surface-mounted		Flush-mounted
Max. cable length	-	Length 4 m, \varnothing 6 mm, (IP 54)	Length 4 m, \varnothing 6 mm, extendable to 50 m
Ambient temperature	-		+0 °C ... +40 °C
Type of protection	IP 20		IP 30
Protection class	II according to EN 60 730-1		

Accessories



Actuator ALPHA 5 230 V
↳ Art.No.: 9070441
Details page 362



Adapter plate RAMSES 714
for RAMSES 714, RAMSES 714 A
↳ Art.No.: 9070212
Details page 360

Scale drawings

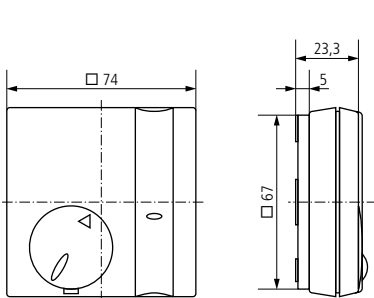

RAMSES 714

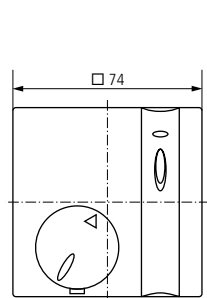

RAMSES 714 A

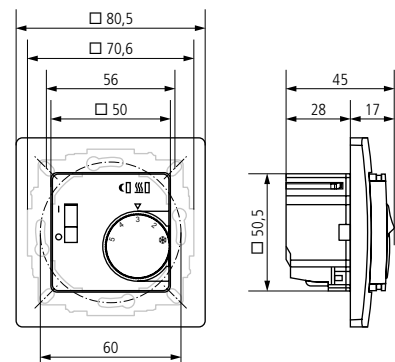

RAMSES 751 RA

Connection diagrams

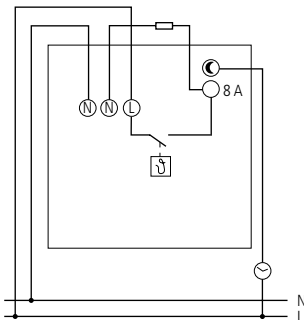

RAMSES 714, RAMSES 714 A

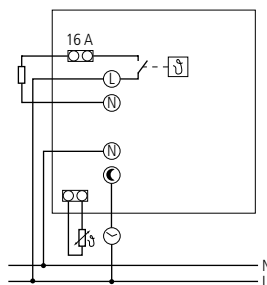

RAMSES 714 A

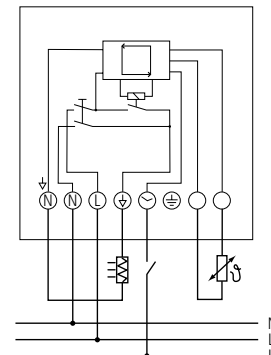







RAMSES 751 RA



Accessories











	Description	Suitable for	Type	Article number
	Wall mounting kit 17,5 mm - Terminal box cover plate for assembly, sealable	- All DIN rail installation devices - width 1 module	Wall mounting kit 17,5 mm	9070065
	Wall mounting kit 35 mm - Terminal box cover plate for assembly, sealable	- All DIN rail installation devices - width 2 modules	Wall mounting kit 35 mm	9070064
	Wall mounting kit 52,5 mm - Terminal box cover plate for assembly, sealable	- All DIN rail installation devices - width 3 modules	Wall mounting kit 52,5 mm	9070050
	Wall mounting kit 70 mm - Terminal box cover plate for assembly, sealable	- All DIN rail installation devices - width 4 modules	Wall mounting kit 70 mm	9070049
	Terminal cover 52,5 mm - Terminal box cover plate for assembly, sealable	- SUL 188 g - SUL 188 hw	Terminal cover 52,5 mm	9070061
	Front panel kit - The front panel installation set is suitable for Theben distributor installation devices of 17.5 to 107.5 mm width - Walls from 1 to 5 mm thick	- All DIN rail installation devices	Front panel kit	9070001
	Snap-on mounting 72 x 72 - Quick fastening for 35 mm DIN-rail	- All devices for front panel/wall installation	Snap-on mounting 72 x 72	9070071
	PC set OBELISK top2/3 - Switching programs created on the PC by means of the convenient OBELISK top2/3 software can be transferred via USB interface to the OBELISK top2 memory card and from the card to the time switch and vice versa. Thus no PC or laptop is required on-site. Programming and the program printout can be done comfortably from the desk - For Windows Vista/7/8/10 (32/64 Bit) - Consisting of: Memory card, USB plug adapter, software - Updates of existing OBELISK top2 software are available as free downloads at www.theben.de	- TR top2 - TR top3 - LUNA top3 - SELEKTA top2 - SELEKTA top3 - TR top2 KNX	PC set OBELISK top2	9070409

	Description	Suitable for	Type	Article number
	Bluetooth OBELISK top3 - Bluetooth low-energy dongle for the transfer of switching programs and direct commands from the app to the time switch - Maximum manipulation security, Time switch programs can only be transferred from the app to the time switch when the Bluetooth OBELISK top3 is plugged into the time switch - Low consumption on standby compared with permanently installed Bluetooth components	- TR top3 - SELEKTA top3 - LUNA top3	Bluetooth OBELISK top3	9070130
	Memory card OBELISK top2 - Individual memory card	- TR top2 - LUNA top2 - LUNA top3 - SELEKTA top2 - TR top2 KNX	Memory card OBELISK top2	9070404
	Antenna RC-DCF - Radio control via DCF antenna with top2 RC devices: To ensure good reception, do not install the antenna in cellars or on distribution boxes. Connection is made via separate 2-wire, unscreened high-voltage power cable (max. 100 m), up to 10 Theben top2 RC devices can be connected. Polarity, short-circuit and interruption of the antenna circuit are each visually displayed to help with installation.	- TR top2 RC - TR top3 RC - LUNA top3 RC - LUNA top2 RC - SELEKTA top2 RC - TR top2 KNX	Antenna RC-DCF	9070410
	Antenna RC-GNSS - Worldwide time synchronisation and positioning via receiving GPS satellite signal - The antenna is connected by a 2 wire cable (max. 100 m) to Theben top2/3 RC devices (up to 5 devices can be connected depending on device type) - Positioning is only possible when connecting to TR 641 top2 RC, TR 642 top2 RC, TR 644 top2 RC and SELEKTA 171 top2 RC devices - Can not be used with TR 611 top2 RC 24 V and SELEKTA 171 top2 RC 24V	- TR top2 RC - TR top3 RC - LUNA top2 RC - SELEKTA top2 RC - TR top2 KNX	Antenna RC-GNSS	9070823
	Antenna RC-GNSS R - As antenna RC-GNSS, but: - Rugged encapsulated housing - Impact resistance IK 8, protection degree IP 65	- TR top2 RC - TR top3 RC - LUNA top2 RC - SELEKTA top2 RC - TR top2 KNX	Antenna RC-GNSS R	9070807
	Cover 55 x 55 for BZ - Cover for hour counter	- BZ 142-1	Cover 55 x 55 for BZ	9070041
	Cover 72 x 72 for BZ - Cover for hour counter	- BZ 142-1	Cover 72 x 72 for BZ	9070074













Accessories











	Description	Suitable for	Type	Article number
	Surface frame PresenceLight - Presence detector surface frame	- PresenceLight 180 - PresenceLight 360	Surface frame PresenceLight (white)	9070513
			Surface frame PresenceLight BK (black)	9070634
	Cover frame PresenceLight 360 - Cover frame for presence detector PresenceLight 360	- PresenceLight 360	Cover frame PresenceLight 360 WH (white)	9070510
			Cover frame PresenceLight 360 BK (black)	9070632
			Cover frame PresenceLight 360 SR (silver)	9070631
	Cover frame PresenceLight 180 - Cover frame for presence detector PresenceLight 180	- PresenceLight 180	Cover frame PresenceLight 180 WH (white)	9070629
			Cover frame PresenceLight 180 BK (black)	9070628
			Cover frame PresenceLight 180 SR (silver)	9070627
	Surface frame compact - Presence detector surface frame	- compact office - compact passage - compact passimo	Surface frame compact (white)	9070514
			Surface frame compact BK (black)	9070637
			Surface frame compact SR (silver)	9070638
	Surface frame 110A - Presence detector surface frame	- thePrema - theRonda P - theMova P - thePassa	Surface frame 110A WH (white)	9070912
			Surface frame 110A GR (grey)	9070913
	Surface frame 110B - Presence detector surface frame	- thePrema KNX	Surface frame 110B WH (white)	9070918
			Surface frame 110B GR (grey)	9070919
	Ceiling installation box 68A - Ceiling installation unit, ensures strain relief and contact protection at the same time. The installation diameter is 68 mm	- thePrema - theRonda P - theMova P - thePassa	Ceiling installation box 68A	9070992

	Description	Suitable for	Type	Article number
	Cover 110 GR - Cover in grey	- theRonda UP - theMova P - thePassa P	Cover 110 GR	9070591
	Cover 85 GR - Cover in grey	- theRonda DE - theMova DE	Cover 85 GR	9070594
	Cover FLAT 85 GR - Cover in grey	- theRonda S60 KNX FLAT DE WH	Cover FLAT 85 GR	9070597
	Masking clip - For limiting the detection area - 5 pieces included in delivery	- theRonda P - theMova P - thePassa	Masking clip	9070921
	Surface frame 75B - Presence detector surface frame	- PlanoSpot	Surface frame 75B WH (white) Surface frame 75B BK (black)	9070796 9070824
	Cover frame PlanoCover - Cover frame for presence detector PlanoSpot - Diameter 76 mm	- PlanoSpot	PlanoCover 76 BK (black) PlanoCover 76 SR (silver)	9070977 9070978
	QuickSafe - QuickSafe safety cover - Secure protection against mechanical damage - Robust and solid design - Particularly impact resistant - 6 screws, 3 rawlplugs and three spacers - Protection class IK07	- All ThebenHTS presence detectors	QuickSafe	9070531
	RC filter - Suppression filter for presence and motion detectors	- All presence and motion detectors	RC filter	9070523
	Corner angle theLuxa E - For corner installation of motion detectors - Wall installation, external corner installation	- theLuxa E180	Corner angle theLuxa E WH (white) Corner angle theLuxa E BK (black)	9070974 9070975
	Spacer theLuxa S BK - Additional spacer for flexible installation (cable entry below, side, top and more space for cables)	- theLuxa S150 - the LuxaS180 - theLuxa S360	Spacer theLuxa S BK	9070907
	Spacer theLuxa S WH - Additional spacer for flexible installation (cable entry below, side, top and more space for cables)	- theLuxa S150 - the LuxaS180 - theLuxa S360	Spacer theLuxa S WH	9070906



Accessories

	Description	Suitable for	Type	Article number
	Spacer theLuxe P BK - Additional spacer for flexible installation (cable entry below, side, top and more space for cables)	- theLuxe P220 - theLuxe P300 - theLuxe P300 KNX	Spacer theLuxe P BK	9070909
	Spacer theLuxe P WH - Additional spacer for flexible installation (cable entry below, side, top and more space for cables)	- theLuxe P220 - theLuxe P300 - theLuxe P300 KNX	Spacer theLuxe P WH	9070908
	Corner angle theLuxe S BK - For corner installation of motion detectors - Wall installation, external corner installation	- theLuxe S150 - theLuxe S180 - theLuxe S360	Corner angle theLuxe S BK	9070903
	Corner angle theLuxe S WH - For corner installation of motion detectors - Wall installation, external corner installation	- theLuxe S150 - theLuxe S180 - theLuxe S360	Corner angle theLuxe S WH	9070902
	Corner angle theLuxe P BK - For corner installation of motion detectors - Wall installation, external corner installation	- theLuxe P220 - theLuxe P300 - theLuxe P300 KNX	Corner angle theLuxe P BK	9070905
	Corner angle theLuxe P WH - For corner installation of motion detectors - Wall installation, external corner installation	- theLuxe P220 - theLuxe P300 - theLuxe P300 KNX	Corner angle theLuxe P WH	9070904
	Corner angle 10 AL - For corner installation of motion detectors - Wall installation, external corner installation	- theLeda P - theLeda D	Corner 10 AL	9070970
	Corner angle 10 BK - For corner installation of motion detectors - Wall installation, external corner installation	- theLeda S - theLuxe R	Corner angle 10 BK	9070987
	Corner angle 10 WH - For corner installation of motion detectors - Wall installation, external corner installation	- theLeda S - theLuxe R	Corner angle 10 WH	9070969
	Spacer 10 AL - Additional spacer for flexible installation (cable entry below, side, top and more space for cables)	- theLeda P - theLeda D	Spacer 10 AL	9070972

	Description	Suitable for	Type	Article number
	Spacer 10 BK - Additional spacer for flexible installation (cable entry below, side, top and more space for cables)	- theLeda S - theLuxa R	Spacer 10 BK	9070988
	Spacer 10 WH - Additional spacer for flexible installation (cable entry below, side, top and more space for cables)	- theLeda S - theLuxa R	Spacer 10 WH	9070971
	Surface frame LUXA 103-100 - Motion detector surface frame	- LUXA 103-100 UA	Surface frame LUXA 103-100 U	9070986
	Surface frame LUXA 103-200 - Motion detector surface frame	- LUXA 103-200	Surface frame LUXA 103-200	9070504
	Cover 45A BJBSI WH - Cover for frames Busch-Jaeger balance SI	- theMura - 4-way push button module - TR 030 top3 UP - SELEKTA 070 top3 UP	Cover 45A BJBSI WH	9070788
	Cover 45A JAS WH - Cover for frames Jung Serie A (A 500, A plus, A creation, AS 500)	- theMura - 4-way push button module - TR 030 top3 UP - SELEKTA 070 top3 UP	Cover 45A JAS WH	9070789
	Cover 45A MMP WH - Cover for frames Merten System M (1-M, Atelier-M, M-Smart, M-Pure, M-Plan, M-Creativ)	- theMura - 4-way push button module - TR 030 top3 UP - SELEKTA 070 top3 UP	Cover 45A MMP WH	9070790
	Cover 45A GS WH - Cover for frames Gira System 55 (Standard 55, E2, Event, Esprit)	- theMura - 4-way push button module - TR 030 top3 UP - SELEKTA 070 top3 UP	Cover 45A GS WH	9070791
	Cover 45A BS WH - Cover for frames Berker S.1	- theMura - 4-way push button module - TR 030 top3 UP - SELEKTA 070 top3 UP	Cover 45A BS WH	9070792
	Cover 45A BJRE WH - Cover for frames Busch-Jaeger Reflex SI	- theMura - 4-way push button module - TR 030 top3 UP - SELEKTA 070 top3 UP	Cover 45A BJRE WH	9070754



Accessories

	Description	Suitable for	Type	Article number
	Motion module RC theLeda B WH - theLeda B radio-controlled motion detector module - 180° detection angle at 12 m range - Additional light switch output - Sensor can be turned horizontally by ± 90° and downwards/backwards by 90° - IP 55 protection rating - theLeda B remote control included in scope of supply for the motion detector module - A remote control can be combined with different motion detector modules - Up to 6 remote controls can be combined with a single motion detector module - Remote control range up to 100 m on open air test site	- theLeda B	Motion module RC theLeda B WH	9070800
	Motion module RC theLeda B BK - As Motion module RC theLeda B WH, but: - Black vesion	- theLeda B	Motion module RC theLeda B BK	9070801
	Motion module theLeda B WH - theLeda B motion detector module - 180° detection angle at 12 m range - Additional light switch output - Sensor can be turned horizontally by ± 90° and downwards/backwards by 90° - Protection rating IP 55	- theLeda B	Motion module theLeda B WH	9070760
	Motion module theLeda B BK - As Motion module theLeda B WH, but: - Black vesion	- theLeda B	Motion module theLeda B BK	9070761
	Light module theLeda B WH - theLeda B light sensor module - Duty cycle range: 2, 4, 6, 8 hours, on / permanent on at night - Switch-on brightness can be set from 2 – 200 lux - Additional light switch output - Protection rating IP 55	- theLeda B	Light module theLeda B WH	9070762
	Light module theLeda B BK - As Light module RC theLeda B WH, but: - Black vesion	- theLeda B	Light module theLeda B BK	9070763
	Spike theLeda D - Spike for ground mounting of the LED bollard light theLeda D B - Length 405 mm	- theLeda D B	Spike theLeda D	9070765

	Description	Suitable for	Type	Article number
	<p>theSenda B</p> <ul style="list-style-type: none"> - Remote control for communication of theSenda Plug App with the detectors - Functions remote control theSenda B: - Universally applicable remote control for many indoor and outdoor detectors - Integrated lux meter - Easy comparison of brightness measurement with theSenda Plug App - Flexible infrared communication with the detector and via Bluetooth with the smartphone - Wide range of functions: Switching and dimming for three light channels, two scenes, customizable buttons - Features theSenda Plug App: - Universal app free of charge for iOS and Android smartphones - All detectors are pre-installed and automatically updated - Automatic detector search via filter function or via stored parameter sets - Parameter sets can be saved on a customer-specific basis, stored in parameter libraries and created and read externally 	<ul style="list-style-type: none"> - thePrema - theRonda - theLuxa P - theMova - theLeda P - PresenceLight KNX - PlanoSpot - thePassa 	theSenda B	9070985
	<p>theSenda P</p> <ul style="list-style-type: none"> - Service remote control - ON/OFF - Teach-in function for teaching in the current brightness value - Predefined brightness values and switch-on times - Impulse, reset and test function 	<ul style="list-style-type: none"> - thePrema - theRonda - theLuxa P - theMova - theLeda P - PresenceLight KNX - PlanoSpot - thePassa 	theSenda P	9070910
	<p>theSenda S</p> <ul style="list-style-type: none"> - User remote control - ON/OFF - Automatic - Presence simulation - Twilight switch - Call up of light scenes 	<ul style="list-style-type: none"> - thePrema - theRonda - theLuxa P - theMova - theLeda P - PresenceLight KNX - PlanoSpot - thePassa 	theSenda S	9070911
	<p>Adapter plate LUNA star</p> <ul style="list-style-type: none"> - The adapter plate simplifies the replacement of faulty twilight switches from Eberle, ESYLUX, Legrand, Grässlin, Hager, Merten, Senmatic, Theben etc. As the plate has standard fixing holes, no further holes need to be drilled in the facade, 2 installation screws included. 	<ul style="list-style-type: none"> - LUNA 126 star E - LUNA 127 star S 	Adapter plate LUNA star	9070486
	<p>LUNA star adapter mast fixing</p> <ul style="list-style-type: none"> - Adapter for attaching the LUNA star products to the mast fixing S 	<ul style="list-style-type: none"> - LUNA 126 star E - LUNA 127 star S 	LUNA star adapter mast fixing	9070793
	<p>Surface-mounted light sensor plus</p> <ul style="list-style-type: none"> - Sensor rotatable - With mounting bracket and screw terminals - Protection class IP 55 - Dimensions: 95 x 48 x 45 mm 	<ul style="list-style-type: none"> - LUNA 108 plus 	Surface-mounted light sensor plus	9070991
	<p>Flush-mounted light sensor plus</p> <ul style="list-style-type: none"> - Spring terminals - Protection class IP 66 	<ul style="list-style-type: none"> - LUNA 108 plus 	Flush-mounted light sensor plus	9070990
	<p>Digital flush-mounted light sensor</p> <ul style="list-style-type: none"> - Spring terminals - Protection class IP 66 	<ul style="list-style-type: none"> - LUNA 110 plus - LUNA 111 top3 - LUNA 112 top3 - LUNA 121 top3 RC - LUNA 122 top3 RC - LUNA 134 KNX 	Digital flush-mounted light sensor	9070456



Accessories







	Description	Suitable for	Type	Article number
	Digital surface-mounted light sensor - Sensor rotatable - With mounting bracket and screw terminals - Protection class IP 55 - Dimensions: 95 x 48 x 45 mm	- LUNA 110 plus - LUNA 111 top3 - LUNA 112 top3 - LUNA 121 top3 RC - LUNA 122 top3 RC - LUNA 134 KNX	Digital surface-mounted light sensor	9070415
	Diode module - Required for special functions (group/central function) with LUXOR - DIMAX: Light scenes, two button operation - 2 modules supplied in delivery	- DIMAX 534 plus	Diode module	9070367
	Adapter RAMSES 72x/78x - Wallpaper/wall cover plate for replacement of RAMSES 3...devices with new clock thermostats, e.g. RAMSES 722	- RAMSES 722 - RAMSES 722 S - RAMSES 782 - RAMSES 782 S - RAMSES 784 - RAMSES 784 S - RAMSES 721 - RAMSES 725	Adapter RAMSES 72x/78x	9070245
	Socket RAMSES - Plug-in socket for installing the RAMSES HF clock thermostat on the wall	- RAMSES 813 top2 Set A/ Set S/Set 1 - RAMSES 833 top2 Set 1/2	Socket RAMSES	9070605
	Adapter plate RAMSES 70x - Adapter plate for flush-mounted socket 79 x 79 mm	- RAMSES 701-709	Adapter plate RAMSES 70x	9070480
	Adapter plate RAMSES 714 - Adapter plate for flush-mounted socket 79 x 79 mm	- SOTHIS 715 - RAMSES 714 - RAMSES 714 A - RAMSES 714 A/FH	Adapter plate RAMSES 714	9070212
	External temperature sensor 1 - External temperature sensor	- RAMSES 366/1 top2 - RAMSES 718 S/P KNX - RAMSES 713 FC KNX - CHEOPS control KNX - AMUN 716 S KNX	External temperature sensor 1	9070191

	Description	Suitable for	Type	Article number
	External temperature sensor 2 - With temperature adjustment of ± 3 K	- RAMSES 366 / 1 top2	External temperature sensor 2	9070192
	Temperature sensor RAMSES IP 65 - External room temperature sensor - Protection class IP 65	- RAMSES top2 - RAMSES 816 top2 OT - RAMSES 856 top2 OT - AMUN 716 S KNX - RAMSES 718 KNX - RAMSES BLE - Flush-mounted actuators	Temperature sensor RAMSES IP 65	9070459
	Temperature sensor - Temperature sensor for laying in floor - Type of protection IP 65	- RAMSES top2 - RAMSES 816 top2 OT - RAMSES 856 top2 OT - AMUN 716 S KNX - RAMSES 718 KNX - RAMSES BLE - Flush-mounted actuators	Temperature sensor	9070321
	OT-Box Standard - For expansion of the RAMSES 856 top2 OT system	- RAMSES 856 top2 OT	OT-Box Standard	9070712
	Flow temperature sensor RAMSES - Also required for applications with 2 feed sensors	- RAMSES 816 top2 OT - RAMSES 856 top2 OT	Flow temperature sensor RAMSES	9070371
	External temperature sensor RAMSES - Type of protection IP 65	- RAMSES 816 top2 OT	External temperature sensor	9070463
	Plunge sensor RAMSES - Additionally required for applications with domestic water control or boiler plunge sensor	- RAMSES 816 top2 OT - RAMSES 856 top2 OT	Plunge sensor RAMSES	9070379
	Flush-mounted temperature sensor - Temperature sensor for flush-mounting - Compact design for easy installation in switch / distribution boxes - For use in combination with various KNX products	- Flush-mounted actuators	Flush-mounted temperature sensor	9070496



Accessories

	Description	Suitable for	Type	Article number
	Actuator ALPHA 5 230 V - Actuator for radiators, heating circuit distributors or individual heating circuits - Operating voltage 230 V AC - For opening and closing of valves in the fields of heating, ventilation and air conditioning - The actuator control is by a room thermostat with two-point output or pulse-width-modulation - Inrush current: < 550 mA for max. 100 ms - Dimensions: 48,4 x 44,3 x 52,2 mm - „First open function“ for easy installation and heating start-up - Plug-in installation on valve adapter to suit the most common valve bottoms and heating circuit distributors - Normally closed (Valve is closed when the operating voltage is cut) - Simple snap-on mounting to a valve adapter - Valve adapter not included in delivery - 100 % protection against damaging drives through leaking valves - Function and adjustment checking - Installation vertical, horizontal and up-side-down possible - Up-side-down position may reduce product life through special circumstances (e.g. contaminated water) - Protection against disassembly by means of removable SaveGuard - Guaranteed overvoltage protection	- All clock thermostats - RAMSES 701 – 709 - RAMSES 741 – 748 - RAMSES 714 - RAMSES 751 - HMG 6 T - HME 6 T KNX - HM 6 T KNX - HM 12 T KNX	Actuator ALPHA 5 230 V	9070441
	Actuator ALPHA 5 24 V As Actuator ALPHA 5 230 V, but: - Operating voltage 24 V AC/DC - Inrush current: < 300 mA for max. 2 min.	- All clock thermostats - HMG 6 T - HME 6 T KNX - HM 6 T KNX - HM 12 T KNX - HMT 6 S KNX - HMT 12 S KNX	Actuator ALPHA 5 24 V	9070442
	Valve adapter VA 80 - Valve adapters for Onda, Schlösser(from 1993), Oventrop (M 30 x 1.5), Heimeier, Herb, Therm-Concept, Frank, Roth (distributor), Dinotherm (distributor) - Other adapters available upon request	- ALPHA 5 230 V - ALPHA 5 24 V - CHEOPS control KNX - CHEOPS drive KNX	Valve adapter VA 80	9070437
	Valve adapter VA 78 - Valve adapters for Danfoss RA - Other adapters available upon request	- ALPHA 5 230 V - ALPHA 5 24 V - CHEOPS control KNX - CHEOPS drive KNX	Valve adapter VA 78	9070436
	Frame RAMSES 74x - Frame for mechanical room thermostats - Without central part	- RAMSES 741 - RAMSES 746 - RAMSES 748	Frame RAMSES 74x	9070603
	Central part RAMSES 741/748 - Central part without switch section and setting button	- RAMSES 741 - RAMSES 748	Central part RAMSES 741/748	9070602
	Central part RAMSES 746 - Central part with switch section and setting button	- RAMSES 746	Central part RAMSES 746	9070601

	Description	Suitable for	Type	Article number
	Power unit CO₂-sensor - 24 V/12 W flush-mounted power unit (SELV)	- AMUN 716 R	Power unit CO ₂ -sensor	9070494
	Contact temperature sensor - Contact temperature sensor in the cover flap housing for measuring the temperature at pipes and curved surfaces	- TA 4 S KNX - TA 6 S KNX - TA 8 S KNX	Contact temperature sensor	9070489
	Mast mounting S - For mast or corner installation of max. 2 weather stations Meteodata, LUXOR or LUNA - Diameter 48–60 mm	- LUXOR 440 - LUXORliving M140 - Meteodata KNX - LUNA 131 S KNX - LUNA 133 KNX	Mast mounting S	9070928
	2-way mounting plate ION - For the mounting of two ION push-button sensors on a standard double socket (standard combination distance 71 mm)	- ION KNX - LUXORliving ION	2-way mounting plate ION	9070822
	4-way push button module - 4-way push button module with integrated temperature sensor - For use with the TU 4 RF KNX / LUXORliving T4 RF and TA 6 S KNX - Cover frame included - Adapter frames for integration in common switching ranges available as accessory	- TU 4 RF KNX - TA 6 S KNX - LUXORliving T 4 RF	4-way push button module	9070806
	Power unit 24 V DC - Power pack for supply voltage from PHARAO controllers and sensors. Power unit sufficient for 5 x PhARAO-II 14/15 or 4 x PHARAO-II 24/25 controls - Width: 3 modules	- Meteodata 24V KNX	Power unit 24 V DC	9079330



Index 2021

Alphabetical 2 F

Type	Art.-No.	GTIN	Page
2-way mounting plate ION	9070806	4003468905203	363
4-way push button module	9070822	4003468905173	363
A			
Actuator ALPHA 5 230 V	9070441	4003468901038	362
Actuator ALPHA 5 24 V	9070442	4003468901052	362
Adapter plate LUNA star	9070486	4003468907559	359
Adapter plate RAMSES 70x	9070480	4003468904299	360
Adapter plate RAMSES 714	9070212	4003468900796	360
Adapter RAMSES 72x/78x	9070245	4003468902059	360
AMUN 716 CO2 Monitor	7169100	4003468710258	342
AMUN 716 S KNX	7169230	4003468710197	116
AMUN 716 SR	7160110	4003468710173	344
Antenna RC-DCF	9070410	4003468904077	353
Antenna RC-GNSS	9070823	4003468905357	353
Antenna RC-GNSS R	9070807	4003468905210	353
B			
Bluetooth OBELISK top3	9070130	4003468902639	353
BM 12 T KNX	4940235	4003468490723	82
BM 6 T KNX	4940230	4003468490716	82
BME 6 T KNX	4930235	4003468490242	82
BMG 6 T KNX	4930230	4003468490204	82
BZ 142-1	1420721	4003468140017	310
BZ 142-1 10V	1420821	4003468140420	310
BZ 142-1 230V	1420621	4003468140086	310
BZ 142-1 24V	1424721	4003468140932	310
BZ 142-3	1420723	4003468140024	310
BZ 142-3 10V	1420823	4003468140369	310
BZ 143-1	1430721	4003468140130	310
BZ 145	1450000	4003468140918	310
BZ 145 24V	1459024	4003468141021	310
BZ 146	1460000	4003468146002	312
BZ 147	1470000	4003468147009	312
BZ 148	1480000	4003468148006	312
C			
Ceiling installation box 68A	9070992	4003468905180	354
Central part RAMSES 741/748	9070602	4003468904589	362
Central part RAMSES 746	9070601	4003468904572	362
CHEOPS control KNX	7329201	4003468732014	115
CHEOPS drive KNX	7319200	4003468731000	115
Compensation module LED	9070825	4003468905371	353
Corner angle 10 AL	9070970	4003468901717	356
Corner angle 10 BK	9070987	4003468902110	356
Corner angle 10 WH	9070969	4003468901700	356
Corner angle theLuxe E BK	9070975	4003468900994	355
Corner angle theLuxe E WH	9070974	4003468901939	355
Corner angle theLuxe P BK	9070905	4003468900314	356
Corner angle theLuxe P WH	9070904	4003468900291	356
Corner angle theLuxe S BK	9070903	4003468900284	356
Corner angle theLuxe S WH	9070902	4003468900277	356
Cover 110 GR	9070591	4003468905234	355
Cover 45A BJBSI WH	9070788	4003468904978	357
Cover 45A BJRE WH	9070754	4003468905593	357
Cover 45A BS WH	9070792	4003468905012	357
Cover 45A GS WH	9070791	4003468905005	357

Type	Art.-No.	GTIN	Page
Cover 45A JAS WH	9070789	4003468904985	357
Cover 45A MMP WH	9070790	4003468904992	357
Cover 55 x 55 for BZ	9070041	4003468902004	353
Cover 72 x 72 for BZ	9070074	4003468900925	353
Cover 85 GR	9070594	4003468905265	355
Cover FLAT 85 GR	9070597	4003468905296	355
Cover frame PresenceLight 180 BK	9070628	7612748001640	354
Cover frame PresenceLight 180 SR	9070627	7612748001664	354
Cover frame PresenceLight 180 WH	9070629	7612748001886	354
Cover frame PresenceLight 360 BK	9070632	7612748001237	354
Cover frame PresenceLight 360 SR	9070631	7612748001251	354
Cover frame PresenceLight 360 WH	9070510	7612748001275	354
D			
DALI-Gateway KNX plus	9070929	4003468902394	74
DALI-Gateway S128 KNX	4940302	4003468491751	75
DALI-Gateway S64 KNX	4940301	4003468491690	75
Digital flush-mounted light sensor	9070456	4003468904343	359
Digital surface-mounted light sensor	9070415	4003468904268	360
DIMAX 532 plus	5320001	4003468530016	292
DIMAX 534 plus	5340001	4003468530009	292
DIMAX 541 plus E	5410130	4003468540022	294
DIMAX 542 plus S	5420130	4003468540039	294
DIMAX 544 plus P	5440130	4003468540046	294
Diode module	9070367	4003468903605	360
DM 2 T KNX	4940270	4003468490792	68
DM 4 T KNX	4940275	4003468490808	68
DM 4-2 T KNX	4940280	4003468490907	70
DM 8-2 T KNX	4940285	4003468490891	70
DMB 1 T KNX	4930279	4003468490020	68
DME 2 T KNX	4930275	4003468490013	68
DMG 2 T KNX	4930270	4003468490006	68
DU 1 KNX	4942570	4003468491393	76
DU 1 RF KNX	4941670	4003468491423	78
E			
ELPA 041	0410002	4003468041000	288
ELPA 047	0470002	4003468047002	288
ELPA 1	0010002	4003468010518	284
ELPA 3	0030002	4003468010501	284
ELPA 6	0060002	4003468010525	284
ELPA 6 plus	0060003	4003468000052	284
ELPA 7	0070002	4003468007006	284
ELPA 8	0080002	4003468010068	286
ELPA 9	0090001	4003468010129	286
EM 4 top2	6490104	4003468649008	252
External temperature sensor	9070463	4003468900871	361
External temperature sensor 1	9070191	4003468901915	360
External temperature sensor 2	9070192	4003468901922	361
F			
FCA 1 KNX	4920200	4003468492000	118
FCA 2 KNX	4920210	4003468490983	118
Flow temperature sensor RAMSES	9070371	4003468903629	361
Flush-mounted light sensor plus	9070990	4003468902226	359
Flush-mounted temperature sensor	9070496	4003468905111	361
Frame RAMSES 74x	9070603	4003468904596	362

Type	Art.-No.	GTIN	Page
FRI 77 g	0770033	4003468070024	280
FRI 77 g-2	0770832	4003468070086	280
FRI 77 h-2	0770802	4003468070048	280
Front panel kit	9070001	4003468900109	352
H			
HM 12 T KNX	4940245	4003468490761	112
HM 6 T KNX	4940240	4003468490754	112
HME 6 T KNX	4930245	4003468490198	112
HMG 6 T KNX	4930240	4003468490129	112
HMT 12 S KNX	4900374	4003468491331	114
HMT 6 S KNX	4900373	4003468491324	114
HU 1 KNX	4942540	4003468491522	76
HU 1 RF KNX	4941640	4003468491546	78
I			
Interface USB KNX	9070397	4003468903995	105
iON 102 KNX	4969232	4003468491454	52
iON 104 KNX	4969234	4003468491461	52
iON 108 KNX	4969238	4003468491478	52
IPsecure Interface KNX	9070771	4003468902998	104
IPsecure Router KNX	9070770	4003468902929	104
J			
JM 4 T 24V KNX	4940260	4003468490877	66
JM 4 T KNX	4940250	4003468490778	64
JM 8 T 24V KNX	4940265	4003468490884	66
JM 8 T KNX	4940255	4003468490785	64
JME 4 T 24V KNX	4930265	4003468490860	66
JME 4 T KNX	4930255	4003468490075	64
JMG 4 T 24V KNX	4930260	4003468490853	66
JMG 4 T KNX	4930250	4003468490051	64
JU 1 KNX	4942550	4003468491386	76
JU 1 RF KNX	4941650	4003468491416	78
K			
KNX Set 1 FIX	4990201	4003468491607	107
KNX Set 2 FIX	4990202	4003468491614	107
KNX Set 3 MIX	4990203	4003468491621	107
KNX Set 4 KNX-RF	4990204	4003468491638	107
KNX-OT-Box S	8559201	4003468850220	109
L			
Light module theLeda B BK	9070763	4003468902769	358
Light module theLeda B WH	9070762	4003468902752	358
Line coupler S KNX	9070880	4003468900253	105
LUNA 108 plus AL	1080910	4003468100974	298
LUNA 108 plus EL	1080900	4003468100967	298
LUNA 110 plus AL	1100910	4003468110027	298
LUNA 110 plus EL	1100900	4003468110010	298
LUNA 111 top3 AL	1110130	4003468110034	300
LUNA 111 top3 EL	1110230	4003468110058	300
LUNA 112 top3 AL	1120130	4003468110072	300
LUNA 112 top3 EL	1120230	4003468110089	300
LUNA 121 top3 RC AL	1210130	4003468120101	302
LUNA 121 top3 RC EL	1210230	4003468120118	302
LUNA 122 top3 RC AL	1220130	4003468120125	302
LUNA 122 top3 RC EL	1220230	4003468120132	302
LUNA 126 star E	1260901	4003468120095	304

Type	Art.-No.	GTIN	Page
LUNA 127 star S	1270900	4003468120071	304
LUNA 131 S KNX	1319201	4003468131039	127
LUNA 133 KNX	1339200	4003468133002	126
LUNA 134 KNX	1349200	4003468130032	124
LUNA star adapter mast fixing	9070793	4003468905029	359
LUXA 103-100 AP WH	1030022	4003468100813	202
LUXA 103-100 C DE WH	1030016	4003468101117	204
LUXA 103-100 DE WH	1030012	4003468100790	202
LUXA 103-100 UA WH	1030045	4003468101148	210
LUXA 103-101 AP WH	1030023	4003468100820	202
LUXA 103-101 DE WH	1030013	4003468100806	202
LUXA 103-200 T	1030031	4003468103050	206
LUXORliving B6	4800430	4003468480106	36
LUXORliving D1	4800570	4003468480205	30
LUXORliving D1 RF	4800670	4003468480236	32
LUXORliving D2	4800470	4003468480045	28
LUXORliving D4	4800475	4003468480052	28
LUXORliving H1	4800540	4003468480311	30
LUXORliving H1 RF	4800640	4003468480328	32
LUXORliving H6	4800440	4003468480090	38
LUXORliving H6 24V	4800441	4003468480175	39
LUXORliving iON2	4800412	4003468480267	22
LUXORliving iON4	4800414	4003468480250	22
LUXORliving iON8	4800418	4003468480243	22
LUXORliving IP1	4800495	4003468480168	24
LUXORliving J1	4800550	4003468480199	30
LUXORliving J1 RF	4800650	4003468480229	32
LUXORliving J4	4800450	4003468480083	29
LUXORliving J8	4800455	4003468480076	29
LUXORliving M100	4800491	4003468480281	42
LUXORliving M130	4800492	4003468480298	42
LUXORliving M140	4800490	4003468480113	41
LUXORliving P640	4800990	4003468480007	24
LUXORliving R718	4800480	4003468480120	40
LUXORliving RF1	4800868	4003468480274	34
LUXORliving S1	4800520	4003468480182	30
LUXORliving S1 RF	4800620	4003468480212	32
LUXORliving S16	4800429	4003468480038	26
LUXORliving S4	4800420	4003468480021	26
LUXORliving S8	4800425	4003468480014	26
LUXORliving set drives	4990010	4003468491348	25
LUXORliving set drives and lighting	4990012	4003468491362	25
LUXORliving set drives basic	4990013	4003468491553	25
LUXORliving set lighting	4990011	4003468491355	25
LUXORliving T2	4800402	4003468480137	37
LUXORliving T4	4800404	4003468480144	37
LUXORliving T4 RF	4800604	4003468480335	34
LUXORliving T8	4800408	4003468480151	37
M			
Masking clip	9070921	7612748005495	355
Mast mounting S	9070928	4003468901687	363
Media coupler TP-RF KNX	9070868	4003468905036	80
MEM 190 a	1900001	4003468190050	266
Memory card OBELISK top2	9070404	4003468904053	353

Index 2021

Alphabetical M ... S

Type	Art.-No.	GTIN	Page
Meteodata 140 basic KNX	1409205	4003468140000	122
Meteodata 140 S 24V GPS KNX	1409204	4003468140048	122
Meteodata 140 S 24V KNX	1409201	4003468140031	122
Meteodata 140 S GPS KNX	1409208	4003468140062	122
Meteodata 140 S KNX	1409207	4003468140055	122
Motion module theLeda B BK	9070761	4003468902745	358
Motion module theLeda B WH	9070760	4003468902738	358
O			
OSIRIA 220 AR KNX	5009200	4003468500057	128
OSIRIA 230 AR KNX	5009210	4003468500071	128
OSIRIA 230 SR KNX	5009211	4003468500088	128
OSIRIA 232 BQ KNX	5009223	4003468500293	129
OSIRIA 240 AR KNX	5009230	4003468500132	128
OSIRIA 240 SR KNX	5009231	4003468500149	128
OSIRIA 241 AR KNX	5009240	4003468500170	128
OSIRIA 241 BR KNX	5009241	4003468500187	128
OSIRIA 242 AR KNX	5009250	4003468500194	129
OSIRIA 242 SR KNX	5009251	4003468500200	129
OSIRIA 251 BQ KNX	5009252	4003468500279	129
OT-Box Standard	9070712	4003468904763	361
P			
PC set OBELISK top2/3	9070409	4003468904015	352
PlanoCover 76 BK	9070977	7612748006140	355
PlanoCover 76 SR	9070978	7612748006157	355
PlanoSpot 360 DALI-2 S DE WH	2030190	4003468200360	172
PlanoSpot 360 KNX DE WH	2039100	7612748005839	90
Plunge sensor RAMSES	9070379	4003468903711	361
Power unit CO2-sensor	9070494	4003468904534	363
PresenceLight 180	2000050	7612748001602	158
PresenceLight 180B-KNX WH	2009050	7612748003835	100
PresenceLight 360B-KNX WH	2009000	7612748003750	98
PS 160 mA T KNX	9070956	4003468902271	106
PS 320 mA T KNX	9070957	4003468902288	106
PS 640 mA T KNX	9070958	4003468902295	106
Q			
QuickSafe	9070531	7612748000582	355
R			
RAMSES 366/1 top2	3660100	4003468360026	322
RAMSES 701	7010001	4003468701140	346
RAMSES 702	7020001	4003468702055	346
RAMSES 703	7030001	4003468703052	346
RAMSES 704	7040001	4003468704028	346
RAMSES 705	7050001	4003468705032	346
RAMSES 706	7060001	4003468706022	346
RAMSES 707	7070001	4003468707029	346
RAMSES 708	7080001	4003468708026	346
RAMSES 709	7090001	4003468709030	346
RAMSES 713 FC KNX	7139202	4003468713020	117
RAMSES 714	7140002	4003468714126	350
RAMSES 714 A	7140016	4003468714133	350
RAMSES 718 P KNX	7189210	4003468710210	110
RAMSES 718 S KNX	7189200	4003468710203	111
RAMSES 721	7210030	4003468721018	336
RAMSES 722	7220030	4003468722015	336

Type	Art.-No.	GTIN	Page
RAMSES 722 S	7220801	4003468722022	334
RAMSES 725	7250030	4003468725016	336
RAMSES 741	7410130	4003468741023	348
RAMSES 741 RA	7410131	4003468741030	348
RAMSES 746	7460130	4003468746028	348
RAMSES 746 RA	7460131	4003468746035	348
RAMSES 748	7480130	4003468748022	348
RAMSES 748 RA	7480131	4003468748039	348
RAMSES 751 RA	7510131	4003468751008	350
RAMSES 782	7820030	4003468782019	336
RAMSES 784	7840030	4003468784013	336
RAMSES 784 S	7840801	4003468784020	334
RAMSES 811 top2	8119132	4003468811139	324
RAMSES 812 BLE	8120150	4003468810033	316
RAMSES 812 top2	8120132	4003468812037	320
RAMSES 813 top2 HF Set 1	8139501	4003468813218	326
RAMSES 813 top2 HF Set A	8139503	4003468813164	326
RAMSES 814 BLE UP	8140150	4003468810040	317
RAMSES 816 BLE	8169150	4003468850244	318
RAMSES 816 BLE 2	8169151	4003468810057	318
RAMSES 816 BLE 3	8169152	4003468810064	318
RAMSES 816 top2 OT	8169132	4003468810002	330
RAMSES 831 top2	8319132	4003468831052	324
RAMSES 832 top2	8320132	4003468832035	320
RAMSES 833 top2 HF Set 1	8339501	4003468833049	328
RAMSES 833 top2 HF Set 2	8339502	4003468833056	328
RAMSES 850 BLE OT	8509150	4003468850237	323
RAMSES 856 top2 OT	8569132	4003468850084	332
RC filter	9070523	7612748001701	355
RM 16 S KNX	4940225	4003468491256	60
RM 16 T KNX	4940205	4003468490846	62
RM 4 H KNX	4940212	4003468491430	58
RM 4 I KNX	4940210	4003468490297	56
RM 4 U KNX	4940223	4003468490976	54
RM 8 H KNX	4940217	4003468491447	58
RM 8 I KNX	4940215	4003468490303	56
RM 8 S KNX	4940220	4003468490990	60
RM 8 T KNX	4940200	4003468490839	62
RME 4 I KNX	4930215	4003468493090	56
RME 4 U KNX	4930228	4003468490952	54
RME 8 S KNX	4930225	4003468493076	60
RME 8 T KNX	4930205	4003468490822	62
RMG 4 I KNX	4930210	4003468493083	56
RMG 4 U KNX	4930223	4003468490969	54
RMG 8 S KNX	4930220	4003468493069	60
RMG 8 T KNX	4930200	4003468490815	62
S			
SELEKTA 070 top3 UP	700130	4003468070000	258
SELEKTA 170 top2 24V	1704100	4003468170564	248
SELEKTA 170 top3	1700130	4003468170120	248
SELEKTA 171 top2 RC 24V	1714100	4003468171035	248
SELEKTA 171 top3 RC	1710330	4003468170168	248
SELEKTA 172 top2 24V	1724100	4003468172056	248
SELEKTA 172 top3	1720130	4003468170175	248

Type	Art.-No.	GTIN	Page
SELEKTA 172 top3 RC	1720330	4003468170243	248
SELEKTA 174 top3	1740130	4003468170137	248
SELEKTA 175 top3	1750100	4003468100424	248
Set basic KNX AP Multi WH	9070900	4003468905395	88
SME 2 S KNX	4910274	4003468491744	72
SMG 2 S KNX	4910273	4003468491737	72
Snap-on mounting 72 x 72	9070071	4003468900895	352
Socket RAMSES	9070605	4003468904657	360
SOTHIS 715	7150002	4003468715024	345
Spacer 10 AL	9070972	4003468901830	356
Spacer 10 BK	9070988	4003468902707	357
Spacer 10 WH	9070971	4003468901724	357
Spacer theLuxe P BK	9070909	4003468900420	356
Spacer theLuxe P WH	9070908	4003468900413	356
Spacer theLuxe S BK	9070907	4003468900345	355
Spacer theLuxe S WH	9070906	4003468900338	355
Spike theLeda D B	9070765	4003468903278	358
SU 1 KNX	4942520	4003468491379	76
SU 1 RF KNX	4941620	4003468491409	78
SUL 180 a	1800001	4003468183311	266
SUL 181 d	1810011	4003468182383	268
SUL 181 d 24V	1814011	4003468180105	268
SUL 188 g	1880033	4003468181003	270
SUL 188 hw	1880108	4003468181010	270
SUL 189 hw	1890108	4003468181164	276
SUL 189 s	1890801	4003468180631	272
SUL 189 s 110V	1891801	4003468182093	272
SUL 191 w	1910011	4003468191040	268
SUL 285/2 T	2850033	4003468285022	278
SUL 289 g	2890033	4003468280096	274
SUL 289 h	2890008	4003468280089	274
Surface frame 110A GR	9070913	7612748004917	354
Surface frame 110A WH	9070912	7612748004900	354
Surface frame 110B GR	9070919	7612748005471	354
Surface frame 110B WH	9070918	7612748005464	354
Surface frame 75B BK	9070824	4003468905364	355
Surface frame 75B WH	9070796	4003468905043	355
Surface frame LUXA 103-100 U	9070986	4003468902080	357
Surface frame LUXA 103-200	9070504	4003468904367	357
Surface frame PresenceLight	9070513	7612748001145	354
Surface frame PresenceLight BK	9070634	7612748001176	354
Surface-mounted light sensor plus	9070991	4003468902332	359
SYN 151 h	1510011	4003468151006	268
SYN 160 a	1600001	4003468161609	266
SYN 161 d	1610011	4003468161371	268
SYN 169 s	1690801	4003468160633	272
SYN 269 h	2690008	4003468260012	274
T			
TA 2 S KNX	4969222	4003468491263	84
TA 4 S KNX	4969224	4003468491270	84
TA 6 S KNX	4969226	4003468491287	84
TA 8 S KNX	4969228	4003468491294	84
TC 649 E	6490130	4003468640029	253
Temperature sensor	9070321	4003468903360	361

Type	Art.-No.	GTIN	Page
Temperature sensor	9070489	4003468902837	363
Temperature sensor RAMSES IP 65	9070459	4003468903810	361
Terminal cover 52,5 mm	9070061	4003468900802	352
theben-eltimo 020 S	0200000	4003468022313	262
theben-eltimo 020 S DCF	0200300	4003468024034	262
theben-timer 26	0260030	4003468020821	279
theben-timer 26 IP 44	0260855	4003468020166	279
theben-timer 27	0270930	4003468020869	279
theLeda B Motion Module RC BK	9070801	4003468905081	358
theLeda B Motion Module RC WH	9070800	4003468905074	358
theLeda B100L BK	1020682	4003468101407	226
theLeda B100L WH	1020681	4003468101391	226
theLeda B20L BK	1020684	4003468101421	226
theLeda B20L WH	1020683	4003468101414	226
theLeda B30L BK	1020686	4003468101445	226
theLeda B30L WH	1020685	4003468101438	226
theLeda B50L BK	1020688	4003468101469	226
theLeda B50L WH	1020687	4003468101452	226
theLeda D B AL	1020905	4003468101254	240
theLeda D B plus AL	1020906	4003468101261	240
theLeda D B plus S AL	1020907	4003468101513	240
theLeda D BL AL	1020705	4003468101193	240
theLeda D BL plus AL	1020706	4003468101209	240
theLeda D S AL	1020901	4003468101216	236
theLeda D SL AL	1020701	4003468101155	238
theLeda D SU AL	1020902	4003468101223	236
theLeda D SUL AL	1020702	4003468101162	238
theLeda D U AL	1020903	4003468101230	236
theLeda D UD AL	1020904	4003468101247	236
theLeda D UDL AL	1020704	4003468101186	238
theLeda D UL AL	1020703	4003468101179	238
theLeda P12 AL	1020942	4003468100684	232
theLeda P12 WH	1020941	4003468100677	232
theLeda P12L AL	1020742	4003468100646	234
theLeda P12L WH	1020741	4003468100639	234
theLeda P24 AL	1020944	4003468100707	232
theLeda P24 WH	1020943	4003468100691	232
theLeda P24L AL	1020744	4003468100660	234
theLeda P24L WH	1020743	4003468100653	234
theLeda S10 BK	1020922	4003468100899	228
theLeda S10 W BK	1020932	4003468100936	228
theLeda S10 W WH	1020931	4003468100929	228
theLeda S10 WH	1020921	4003468100882	228
theLeda S10L BK	1020722	4003468100851	230
theLeda S10L WH	1020721	4003468100837	230
theLeda S20 BK	1020924	4003468100912	228
theLeda S20 W BK	1020934	4003468100950	228
theLeda S20 W WH	1020933	4003468100943	228
theLeda S20 WH	1020923	4003468100905	228
theLeda S20L BK	1020724	4003468100875	230
theLeda S20L WH	1020723	4003468100868	230
theLuxe E180 BK	1010206	4003468100721	214
theLuxe E180 WH	1010205	4003468100714	214
theLuxe P220 BK	1010606	4003468100318	222

Index 2021

Alphabetical T ... T

Type	Art.-No.	GTIN	Page	Type	Art.-No.	GTIN	Page
theLuxa P220 WH	1010605	4003468100288	222	theRonda P360 DALI-2 S UP WH	2080090	4003468200377	168
theLuxa P300 BK	1010611	4003468100356	222	theRonda P360 KNX UP WH	2089000	7612748005433	92
theLuxa P300 KNX BK	1019611	4003468100387	102	theRonda P360 Slave UP WH	2080030	7612748006119	148
theLuxa P300 KNX WH	1019610	4003468100370	102	theRonda P360-100 M UP WH	2080020	7612748006171	148
theLuxa P300 WH	1010610	4003468100332	222	theRonda P360-100 WH GST	2080010	4003468200018	150
theLuxa R180 BK	1010201	4003468100783	216	theRonda P360-101 M UP WH	2080025	7612748006201	148
theLuxa R180 WH	1010200	4003468100776	216	theRonda P360-110 DALI UP WH	2080040	7612748006348	164
theLuxa S150 BK	1010501	4003468100226	218	theRonda P360-330 DALI UP WH	2080045	7612748006317	164
theLuxa S150 WH	1010500	4003468100219	218	theRonda S360 DALI-2 S UP WH	2080590	4003468200384	168
theLuxa S180 BK	1010506	4003468100257	218	theRonda S360 KNX AP GR	2089551	7612748006454	94
theLuxa S180 WH	1010505	4003468100240	218	theRonda S360 KNX AP WH	2089550	7612748006447	94
theLuxa S360 BK	1010511	4003468100271	220	theRonda S360 KNX FLAT DE WH	2089560	7612748006416	94
theLuxa S360 WH	1010510	4003468100264	220	theRonda S360 Slave UP WH	2080530	7612748006638	146
theMova P360-100 UP WH	1030600	7612748005105	200	theRonda S360-100 AP GR	2080551	7612748005976	142
theMova S360-100 AP GR	1030551	7612748005020	196	theRonda S360-100 AP WH	2080550	7612748005969	142
theMova S360-100 AP WH	1030550	7612748005013	196	theRonda S360-100 DE WH	2080560	7612748006027	140
theMova S360-100 DE WH	1030560	7612748004986	194	theRonda S360-100 FLAT DE WH	2080540	4003468200421	138
theMova S360-100 FLAT DE WH	1030540	4003468101698	192	theRonda S360-100 UP WH	2080520	7612748006621	146
theMova S360-100 WH GST	1030570	4003468100738	198	theRonda S360-100 WH GST	2080570	4003468200032	144
theMova S360-101 AP GR	1030556	7612748005082	196	theRonda S360-101 AP GR	2080556	7612748006003	142
theMova S360-101 AP WH	1030555	7612748005075	196	theRonda S360-101 AP WH	2080555	7612748005990	142
theMova S360-101 DE WH	1030565	7612748005044	194	theRonda S360-101 DE WH	2080565	7612748006058	140
theMova S360-101 FLAT DE WH	1030545	4003468101704	192	theRonda S360-101 FLAT DE WH	2080545	4003468200438	138
theMura S180 Slave B UP	2060760	4003468200179	160	theRonda S360-101 UP WH	2080525	7612748006591	146
theMura S180 Slave UP WH	2060660	4003468200131	160	theRonda S360-110 DALI UP WH	2080580	7612748006379	164
theMura S180-100 2W B UP	2060770	4003468200186	160	theSenda B	9070985	4003468902073	359
theMura S180-100 2W UP WH	2060670	4003468200148	160	theSenda P	9070910	4003468900475	359
theMura S180-100 B UP	2060750	4003468200155	160	theSenda S	9070911	4003468900505	359
theMura S180-100 UP WH	2060650	4003468200117	160	TM 179 h	1790008	4003468170151	276
theMura S180-101 B UP	2060755	4003468200162	160	TM 345 B	3450730	4003468340103	308
theMura S180-101 UP WH	2060655	4003468200124	160	TM 345 M	3450731	4003468340110	308
thePassa P360 DALI-2 S UP WH	2010390	4003468200353	170	TR 030 top3 UP	0300130	4003468030134	258
thePassa P360 KNX UP WH	2019300	7612748006492	96	TR 608 top2 S	6080101	4003468600115	254
thePassa P360 Slave UP WH	2010330	7612748006539	152	TR 609 top2 S	6090101	4003468600122	254
thePassa P360-101 UP WH	2010300	7612748006478	152	TR 610 top2 24V	6104100	4003468613009	244
thePassa P360-221 DALI UP WH	2010340	7612748006515	166	TR 610 top2 G	6100110	4003468612590	244
thePiccola P360-100 DE WH	2090200	4003468200001	136	TR 610 top3	6100130	4003468610299	244
thePiccola S360-100 DE WH	1060200	4003468100622	190	TR 611 top2 24V	6114100	4003468613016	246
thePrema P360 KNX AP Multi WH	2079900	4003468200414	88	TR 611 top2 RC 24V	6114300	4003468612231	246
thePrema P360 KNX UP GR	2079001	7612748004467	86	TR 611 top3	6110130	4003468610312	246
thePrema P360 KNX UP WH	2079000	7612748004450	86	TR 611 top3 RC	6110330	4003468610343	246
thePrema P360 Slave E UP GR	2070131	7612748005631	156	TR 612 top2 24V	6124100	4003468613023	244
thePrema P360 Slave E UP WH	2070130	7612748005624	156	TR 612 top3	6120130	4003468610305	244
thePrema P360-101 E UP GR	2070106	7612748005549	156	TR 622 top2 24V	6224100	4003468613030	248
thePrema P360-101 E UP WH	2070105	7612748005532	156	TR 622 top3	6220130	4003468620021	246
thePrema S360 DALI UP GR	2070526	7612748004627	162	TR 635 top2	6350100	4003468630006	256
thePrema S360 DALI UP WH	2070525	7612748004610	162	TR 636 top2	6360100	4003468630020	256
thePrema S360 KNX UP GR	2079501	7612748004504	86	TR 641 top2	6410100	4003468641088	250
thePrema S360 KNX UP WH	2079500	7612748004498	86	TR 641 top2 RC	6410300	4003468641118	250
thePrema S360 Slave E UP GR	2070631	7612748005662	154	TR 641 top2 RC 24V	6414300	4003468641125	250
thePrema S360 Slave E UP WH	2070630	7612748005655	154	TR 642 top2	6420100	4003468642085	250
thePrema S360-100 E UP GR	2070601	7612748005600	154	TR 642 top2 RC	6420300	4003468642108	250
thePrema S360-100 E UP WH	2070600	7612748005594	154	TR 642 top2 RC 24V	6424300	4003468642115	250
thePrema S360-101 E UP GR	2070606	7612748005570	154	TR 644 top2	6440100	4003468644232	250
thePrema S360-101 E UP WH	2070605	7612748005563	154	TR 644 top2 RC	6440300	4003468644218	250

Type	Art.-No.	GTIN	Page
TR 648 top2 RC KNX	6489212	4003468640012	120
TR 648 top2 RC-DCF KNX	6489210	4003468640005	120
TR 684-1 top2	6840100	4003468680254	260
TU 4 RF KNX	4961604	4003468491539	80
V			
Valve adapter VA 78	9070436	4003468904220	362
Valve adapter VA 80	9070437	4003468904237	362
VARIA 826 S WH KNX	8269210	4003468820049	108
W			
Wall mounting kit 17,5 mm	9070065	4003468900833	352
Wall mounting kit 35 mm	9070064	4003468900826	352
Wall mounting kit 52,5 mm	9070050	4003468900734	352
Wall mounting kit 70 mm	9070049	4003468900727	352



Index 2021

Numerical 0010002 ... 14200021

Art.-No.	Type	GTIN	Page
0010002	ELPA 1	4003468010518	284
0030002	ELPA 3	4003468010501	284
0060002	ELPA 6	4003468010525	284
0060003	ELPA 6 plus	4003468000052	284
0070002	ELPA 7	4003468007006	284
0080002	ELPA 8	4003468010068	286
0090001	ELPA 9	4003468010129	286
0200000	theben-eltimo 020 S	4003468022313	262
0200300	theben-eltimo 020 S DCF	4003468024034	262
0260030	theben-timer 26	4003468020821	279
0260855	theben-timer 26 IP 44	4003468020166	279
0270930	theben-timer 27	4003468020869	279
0300130	TR 030 top3 UP	4003468030134	258
0410002	ELPA 041	4003468041000	288
0470002	ELPA 047	4003468047002	288
0700130	SELEKTA 070 top3 UP	4003468070000	258
0770033	FRI 77 g	4003468070024	280
0770802	FRI 77 h-2	4003468070048	280
0770832	FRI 77 g-2	4003468070086	280
1010200	theLuxa R180 WH	4003468100776	216
1010201	theLuxa R180 BK	4003468100783	216
1010205	theLuxa E180 WH	4003468100714	214
1010206	theLuxa E180 BK	4003468100721	214
1010500	theLuxa S150 WH	4003468100219	218
1010501	theLuxa S150 BK	4003468100226	218
1010505	theLuxa S180 WH	4003468100240	218
1010506	theLuxa S180 BK	4003468100257	218
1010510	theLuxa S360 WH	4003468100264	220
1010511	theLuxa S360 BK	4003468100271	220
1010605	theLuxa P220 WH	4003468100288	222
1010606	theLuxa P220 BK	4003468100318	222
1010610	theLuxa P300 WH	4003468100332	222
1010611	theLuxa P300 BK	4003468100356	222
1019610	theLuxa P300 KNX WH	4003468100370	102
1019611	theLuxa P300 KNX BK	4003468100387	102
1020681	theLeda B100L WH	4003468101391	226
1020682	theLeda B100L BK	4003468101407	226
1020683	theLeda B20L WH	4003468101414	226
1020684	theLeda B20L BK	4003468101421	226
1020685	theLeda B30L WH	4003468101438	226
1020686	theLeda B30L BK	4003468101445	226
1020687	theLeda B50L WH	4003468101452	226
1020688	theLeda B50L BK	4003468101469	226
1020701	theLeda D SL AL	4003468101155	238
1020702	theLeda D SUL AL	4003468101162	238
1020703	theLeda D UL AL	4003468101179	238
1020704	theLeda D UDL AL	4003468101186	238
1020705	theLeda D BL AL	4003468101193	240
1020706	theLeda D BL plus AL	4003468101209	240
1020721	theLeda S10L WH	4003468100837	230
1020722	theLeda S10L BK	4003468100851	230
1020723	theLeda S20L WH	4003468100868	230
1020724	theLeda S20L BK	4003468100875	230
1020741	theLeda P12L WH	4003468100639	234
1020742	theLeda P12L AL	4003468100646	234
1020743	theLeda P24L WH	4003468100653	234
1020744	theLeda P24L AL	4003468100660	234
1020901	theLeda D S AL	4003468101216	236

Art.-No.	Type	GTIN	Page
1020902	theLeda D SU AL	4003468101223	236
1020903	theLeda D U AL	4003468101230	236
1020904	theLeda D UD AL	4003468101247	236
1020905	theLeda D B AL	4003468101254	240
1020906	theLeda D B plus AL	4003468101261	240
1020907	theLeda D B plus S AL	4003468101513	240
1020921	theLeda S10 WH	4003468100882	228
1020922	theLeda S10 BK	4003468100899	228
1020923	theLeda S20 WH	4003468100905	228
1020924	theLeda S20 BK	4003468100912	228
1020931	theLeda S10 W WH	4003468100929	228
1020932	theLeda S10 W BK	4003468100936	228
1020933	theLeda S20 W WH	4003468100943	228
1020934	theLeda S20 W BK	4003468100950	228
1020941	theLeda P12 WH	4003468100677	232
1020942	theLeda P12 AL	4003468100684	232
1020943	theLeda P24 WH	4003468100691	232
1020944	theLeda P24 AL	4003468100707	232
1030012	LUXA 103-100 DE WH	4003468100790	202
1030013	LUXA 103-101 DE WH	4003468100806	202
1030016	LUXA 103-100 C DE WH	4003468101117	204
1030022	LUXA 103-100 AP WH	4003468100813	202
1030023	LUXA 103-101 AP WH	4003468100820	202
1030031	LUXA 103-200 T	4003468103050	206
1030045	LUXA 103-100 UA WH	4003468101148	210
1030540	theMova S360-100 FLAT DE WH	4003468101698	192
1030545	theMova S360-101 FLAT DE WH	4003468101704	192
1030550	theMova S360-100 AP WH	7612748005013	196
1030551	theMova S360-100 AP GR	7612748005020	196
1030555	theMova S360-101 AP WH	7612748005075	196
1030556	theMova S360-101 AP GR	7612748005082	196
1030560	theMova S360-100 DE WH	7612748004986	194
1030565	theMova S360-101 DE WH	7612748005044	194
1030570	theMova S360-100 WH GST	4003468100738	198
1030600	theMova P360-100 UP WH	7612748005105	200
1060200	thePiccola S360-100 DE WH	4003468100622	190
1080900	LUNA 108 plus EL	4003468100967	298
1080910	LUNA 108 plus AL	4003468100974	298
1100900	LUNA 110 plus EL	4003468110010	298
1100910	LUNA 110 plus AL	4003468110027	298
1110130	LUNA 111 top3 AL	4003468110034	300
1110230	LUNA 111 top3 EL	4003468110058	300
1120130	LUNA 112 top3 AL	4003468110072	300
1120230	LUNA 112 top3 EL	4003468110089	300
1210130	LUNA 121 top3 RC AL	4003468120101	302
1210230	LUNA 121 top3 RC EL	4003468120118	302
1220130	LUNA 122 top3 RC AL	4003468120125	302
1220230	LUNA 122 top3 RC EL	4003468120132	302
1260901	LUNA 126 star E	4003468120095	304
1270900	LUNA 127 star S	4003468120071	304
1319201	LUNA 131 S KNX	4003468131039	127
1339200	LUNA 133 KNX	4003468133002	126
1349200	LUNA 134 KNX	4003468130032	124
1409201	Meteodata 140 S 24V KNX	4003468140031	122
1409204	Meteodata 140 S 24V GPS KNX	4003468140048	122
1409205	Meteodata 140 basic KNX	4003468140000	122
1409207	Meteodata 140 S KNX	4003468140055	122
1409208	Meteodata 140 S GPS KNX	4003468140062	122

Art.-No.	Type	GTIN	Page
1420621	BZ 142-1 230V	4003468140086	310
1420721	BZ 142-1	4003468140017	310
1420723	BZ 142-3	4003468140024	310
1420821	BZ 142-1 10V	4003468140420	310
1420823	BZ 142-3 10V	4003468140369	310
1424721	BZ 142-1 24V	4003468140932	310
1430721	BZ 143-1	4003468140130	310
1450000	BZ 145	4003468140918	310
1459024	BZ 145 24V	4003468141021	310
1460000	BZ 146	4003468146002	312
1470000	BZ 147	4003468147009	312
1480000	BZ 148	4003468148006	312
1510011	SYN 151 h	4003468151006	268
1600001	SYN 160 a	4003468161609	266
1610011	SYN 161 d	4003468161371	268
1690801	SYN 169 s	4003468160633	272
1700130	SELEKTA 170 top3	4003468170120	248
1704100	SELEKTA 170 top2 24V	4003468170564	248
1710330	SELEKTA 171 top3 RC	4003468170168	248
1714100	SELEKTA 171 top2 RC 24V	4003468171035	248
1720130	SELEKTA 172 top3	4003468170175	248
1720330	SELEKTA 172 top3 RC	4003468170243	248
1724100	SELEKTA 172 top2 24V	4003468172056	248
1740130	SELEKTA 174 top3	4003468170137	248
1750100	SELEKTA 175 top3	4003468100424	248
1790008	TM 179 h	4003468170151	276
1800001	SUL 180 a	4003468183311	266
1810011	SUL 181 d	4003468182383	268
1814011	SUL 181 d 24V	4003468180105	268
1880033	SUL 188 g	4003468181003	270
1880108	SUL 188 hw	4003468181010	270
1890108	SUL 189 hw	4003468181164	276
1890801	SUL 189 s	4003468180631	272
1891801	SUL 189 s 110V	4003468182093	272
1900001	MEM 190 a	4003468190050	266
1910011	SUL 191 w	4003468191040	268
2000050	PresenceLight 180	7612748001602	158
2009000	PresenceLight 360B-KNX WH	7612748003750	98
2009050	PresenceLight 180B-KNX WH	7612748003835	100
2010300	thePassa P360-101 UP WH	7612748006478	152
2010330	thePassa P360 Slave UP WH	7612748006539	152
2010340	thePassa P360-221 DALI UP WH	7612748006515	166
2010390	thePassa P360 DALI-2 S UP WH	4003468200353	170
2019300	thePassa P360 KNX UP WH	7612748006492	96
2030190	PlanoSpot 360 DALI-2 S DE WH	4003468200360	172
2039100	PlanoSpot 360 KNX DE WH	7612748005839	90
2060650	theMura S180-100 UP WH	4003468200117	160
2060655	theMura S180-101 UP WH	4003468200124	160
2060660	theMura S180 Slave UP WH	4003468200131	160
2060670	theMura S180-100 2W UP WH	4003468200148	160
2060750	theMura S180-100 B UP	4003468200155	160
2060755	theMura S180-101 B UP	4003468200162	160
2060760	theMura S180 Slave B UP	4003468200179	160
2060770	theMura S180-100 2W B UP	4003468200186	160
2070105	thePrema P360-101 E UP WH	7612748005532	156
2070106	thePrema P360-101 E UP GR	7612748005549	156
2070130	thePrema P360 Slave E UP WH	7612748005624	156
2070131	thePrema P360 Slave E UP GR	7612748005631	156

Art.-No.	Type	GTIN	Page
2070525	thePrema S360 DALI UP WH	7612748004610	162
2070526	thePrema S360 DALI UP GR	7612748004627	162
2070600	thePrema S360-100 E UP WH	7612748005594	154
2070601	thePrema S360-100 E UP GR	7612748005600	154
2070605	thePrema S360-101 E UP WH	7612748005563	154
2070606	thePrema S360-101 E UP GR	7612748005570	154
2070630	thePrema S360 Slave E UP WH	7612748005655	154
2070631	thePrema S360 Slave E UP GR	7612748005662	154
2079000	thePrema P360 KNX UP WH	7612748004450	86
2079001	thePrema P360 KNX UP GR	7612748004467	86
2079500	thePrema S360 KNX UP WH	7612748004498	86
2079501	thePrema S360 KNX UP GR	7612748004504	86
2079900	thePrema P360 KNX AP Multi WH	40034682000414	88
2080010	theRonda P360-100 WH GST	4003468200018	150
2080020	theRonda P360-100 M UP WH	7612748006171	148
2080025	theRonda P360-101 M UP WH	7612748006201	148
2080030	theRonda P360 Slave UP WH	7612748006119	148
2080040	theRonda P360-110 DALI UP WH	7612748006348	164
2080045	theRonda P360-330 DALI UP WH	7612748006317	164
2080090	theRonda P360 DALI-2 S UP WH	4003468200377	168
2080520	theRonda S360-100 UP WH	7612748006621	146
2080525	theRonda S360-101 UP WH	7612748006591	146
2080530	theRonda S360 Slave UP WH	7612748006638	146
2080540	theRonda S360-100 FLAT DE WH	4003468200421	138
2080545	theRonda S360-101 FLAT DE WH	4003468200438	138
2080550	theRonda S360-100 AP WH	7612748005969	142
2080551	theRonda S360-100 AP GR	7612748005976	142
2080555	theRonda S360-101 AP WH	7612748005990	142
2080556	theRonda S360-101 AP GR	7612748006003	142
2080560	theRonda S360-100 DE WH	7612748006027	140
2080565	theRonda S360-101 DE WH	7612748006058	140
2080570	theRonda S360-100 WH GST	4003468200032	144
2080580	theRonda S360-110 DALI UP WH	7612748006379	164
2080590	theRonda S360 DALI-2 S UP WH	4003468200384	168
2089000	theRonda P360 KNX UP WH	7612748005433	92
2089550	theRonda S360 KNX AP WH	7612748006447	94
2089551	theRonda S360 KNX AP GR	7612748006454	94
2089560	theRonda S360 KNX FLAT DE WH	7612748006416	94
2090200	thePiccola P360-100 DE WH	4003468200001	136
2690008	SYN 269 h	4003468260012	274
2850033	SUL 285/2 T	4003468285022	278
2890008	SUL 289 h	4003468280089	274
2890033	SUL 289 g	4003468280096	274
3450730	TM 345 B	4003468340103	308
3450731	TM 345 M	4003468340110	308
3660100	RAMSES 366/1 top2	4003468360026	322
4800402	LUXORliving T2	4003468480137	37
4800404	LUXORliving T4	4003468480144	37
4800408	LUXORliving T8	4003468480151	37
4800412	LUXORliving iON2	4003468480267	22
4800414	LUXORliving iON4	4003468480250	22
4800418	LUXORliving iON8	4003468480243	22
4800420	LUXORliving S4	4003468480021	26
4800425	LUXORliving S8	4003468480014	26
4800429	LUXORliving S16	4003468480038	26
4800430	LUXORliving B6	4003468480106	36
4800440	LUXORliving H6	4003468480090	38
4800441	LUXORliving H6 24V	4003468480175	39

Index 2021

Numerical 4800495 ... 6414300

Art.-No.	Type	GTIN	Page	Art.-No.	Type	GTIN	Page
4800450	LUXORliving J4	4003468480083	29	4940245	HM 12 T KNX	4003468490761	112
4800455	LUXORliving J8	4003468480076	29	4940250	JM 4 T KNX	4003468490778	64
4800470	LUXORliving D2	4003468480045	28	4940255	JM 8 T KNX	4003468490785	64
4800475	LUXORliving D4	4003468480052	28	4940260	JM 4 T 24V KNX	4003468490877	66
4800480	LUXORliving R718	4003468480120	40	4940265	JM 8 T 24V KNX	4003468490884	66
4800490	LUXORliving M140	4003468480113	41	4940270	DM 2 T KNX	4003468490792	68
4800491	LUXORliving M100	4003468480281	42	4940275	DM 4 T KNX	4003468490808	68
4800492	LUXORliving M130	4003468480298	42	4940280	DM 4-2 T KNX	4003468490907	70
4800495	LUXORliving IP1	4003468480168	24	4940285	DM 8-2 T KNX	4003468490891	70
4800520	LUXORliving S1	4003468480182	30	4940301	DALI-Gateway S64 KNX	4003468491690	75
4800540	LUXORliving H1	4003468480311	30	4940302	DALI-Gateway S128 KNX	4003468491751	75
4800550	LUXORliving J1	4003468480199	30	4941620	SU 1 RF KNX	4003468491409	78
4800570	LUXORliving D1	4003468480205	30	4941640	HU 1 RF KNX	4003468491546	78
4800604	LUXORliving T4 RF	4003468480335	34	4941650	JU 1 RF KNX	4003468491416	78
4800620	LUXORliving S1 RF	4003468480212	32	4941670	DU 1 RF KNX	4003468491423	78
4800640	LUXORliving H1 RF	4003468480328	32	4942520	SU 1 KNX	4003468491379	76
4800650	LUXORliving J1 RF	4003468480229	32	4942540	HU 1 KNX	4003468491522	76
4800670	LUXORliving D1 RF	4003468480236	32	4942550	JU 1 KNX	4003468491386	76
4800868	LUXORliving RF1	4003468480274	34	4942570	DU 1 KNX	4003468491393	76
4800990	LUXORliving P640	4003468480007	24	4961604	TU 4 RF KNX	4003468491539	80
4900373	HMT 6 S KNX	4003468491324	114	4969222	TA 2 S KNX	4003468491263	84
4900374	HMT 12 S KNX	4003468491331	114	4969224	TA 4 S KNX	4003468491270	84
4910273	SMG 2 S KNX	4003468491737	72	4969226	TA 6 S KNX	4003468491287	84
4910274	SME 2 S KNX	4003468491744	72	4969228	TA 8 S KNX	4003468491294	84
4920200	FCA 1 KNX	4003468492000	118	4969232	iON 102 KNX	4003468491454	52
4920210	FCA 2 KNX	4003468490983	118	4969234	iON 104 KNX	4003468491461	52
4930200	RMG 8 T KNX	4003468490815	62	4969238	iON 108 KNX	4003468491478	52
4930205	RME 8 T KNX	4003468490822	62	4990010	LUXORliving set drives	4003468491348	25
4930210	RMG 4 I KNX	4003468493083	56	4990011	LUXORliving set lighting	4003468491355	25
4930215	RME 4 I KNX	4003468493090	56	4990012	LUXORliving set drives and lighting	4003468491362	25
4930220	RMG 8 S KNX	4003468493069	60	4990013	LUXORliving set drives basic	4003468491553	25
4930223	RMG 4 U KNX	4003468490969	54	4990201	KNX Set 1 FIX	4003468491607	107
4930225	RME 8 S KNX	4003468493076	60	4990202	KNX Set 2 FIX	4003468491614	107
4930228	RME 4 U KNX	4003468490952	54	4990203	KNX Set 3 MIX	4003468491621	107
4930230	BMG 6 T KNX	4003468490204	82	4990204	KNX Set 4 KNX-RF	4003468491638	107
4930235	BME 6 T KNX	4003468490242	82	5009200	OSIRIA 220 AR KNX	4003468500057	128
4930240	HMG 6 T KNX	4003468490129	112	5009210	OSIRIA 230 AR KNX	4003468500071	128
4930245	HME 6 T KNX	4003468490198	112	5009211	OSIRIA 230 SR KNX	4003468500088	128
4930250	JMG 4 T KNX	4003468490051	64	5009223	OSIRIA 232 BQ KNX	4003468500293	129
4930255	JME 4 T KNX	4003468490075	64	5009230	OSIRIA 240 AR KNX	4003468500132	128
4930260	JMG 4 T 24V KNX	4003468490853	66	5009231	OSIRIA 240 SR KNX	4003468500149	128
4930265	JME 4 T 24V KNX	4003468490860	66	5009240	OSIRIA 241 AR KNX	4003468500170	128
4930270	DMG 2 T KNX	4003468490006	68	5009241	OSIRIA 241 BR KNX	4003468500187	128
4930275	DME 2 T KNX	4003468490013	68	5009250	OSIRIA 242 AR KNX	4003468500194	129
4930279	DMB 1 T KNX	4003468490020	68	5009251	OSIRIA 242 SR KNX	4003468500200	129
4940200	RM 8 T KNX	4003468490839	62	5009252	OSIRIA 251 BQ KNX	4003468500279	129
4940205	RM 16 T KNX	4003468490846	62	5320001	DIMAX 532 plus	4003468530016	292
4940210	RM 4 I KNX	4003468490297	56	5340001	DIMAX 534 plus	4003468530009	292
4940212	RM 4 H KNX	4003468491430	58	5410130	DIMAX 541 plus E	4003468540022	294
4940215	RM 8 I KNX	4003468490303	56	5420130	DIMAX 542 plus S	4003468540039	294
4940217	RM 8 H KNX	4003468491447	58	5440130	DIMAX 544 plus P	4003468540046	294
4940220	RM 8 S KNX	4003468490990	60	6080101	TR 608 top2 S	4003468600115	254
4940223	RM 4 U KNX	4003468490976	54	6090101	TR 609 top2 S	4003468600122	254
4940225	RM 16 S KNX	4003468491256	60	6100110	TR 610 top2 G	4003468612590	244
4940230	BM 6 T KNX	4003468490716	82	6100130	TR 610 top3	4003468610299	244
4940235	BM 12 T KNX	4003468490723	82	6104100	TR 610 top2 24V	4003468613009	244
4940240	HM 6 T KNX	4003468490754	112	6110130	TR 611 top3	4003468610312	246

Art.-No.	Type	GTIN	Page
6110330	TR 611 top3 RC	4003468610343	246
6114100	TR 611 top2 24V	4003468613016	246
6114300	TR 611 top2 RC 24V	4003468612231	246
6120130	TR 612 top3	4003468610305	244
6124100	TR 612 top2 24V	4003468613023	244
6220130	TR 622 top3	4003468620021	246
6224100	TR 622 top2 24V	4003468613030	248
6350100	TR 635 top2	4003468630006	256
6360100	TR 636 top2	4003468630020	256
6410100	TR 641 top2	4003468641088	250
6410300	TR 641 top2 RC	4003468641118	250
6414300	TR 641 top2 RC 24V	4003468641125	250
6420100	TR 642 top2	4003468642085	250
6420300	TR 642 top2 RC	4003468642108	250
6424300	TR 642 top2 RC 24V	4003468642115	250
6440100	TR 644 top2	4003468644232	250
6440300	TR 644 top2 RC	4003468644218	250
6489210	TR 648 top2 RC-DCF KNX	4003468640005	120
6489212	TR 648 top2 RC KNX	4003468640012	120
6490104	EM 4 top2	4003468649008	252
6490130	TC 649 E	4003468640029	253
6840100	TR 684-1 top2	4003468680254	260
7010001	RAMSES 701	4003468701140	346
7020001	RAMSES 702	4003468702055	346
7030001	RAMSES 703	4003468703052	346
7040001	RAMSES 704	4003468704028	346
7050001	RAMSES 705	4003468705032	346
7060001	RAMSES 706	4003468706022	346
7070001	RAMSES 707	4003468707029	346
7080001	RAMSES 708	4003468708026	346
7090001	RAMSES 709	4003468709030	346
7139202	RAMSES 713 FC KNX	4003468713020	117
7140002	RAMSES 714	4003468714126	350
7140016	RAMSES 714 A	4003468714133	350
7150002	SOTHIS 715	4003468715024	345
7160110	AMUN 716 SR	4003468710173	344
7169100	AMUN 716 CO2 Monitor	4003468710258	342
7169230	AMUN 716 S KNX	4003468710197	116
7189200	RAMSES 718 S KNX	4003468710203	111
7189210	RAMSES 718 P KNX	4003468710210	110
7210030	RAMSES 721	4003468721018	336
7220030	RAMSES 722	4003468722015	336
7220801	RAMSES 722 S	4003468722022	334
7250030	RAMSES 725	4003468725016	336
7319200	CHEOPS drive KNX	4003468731000	115
7329201	CHEOPS control KNX	4003468732014	115
7410130	RAMSES 741	4003468741023	348
7410131	RAMSES 741 RA	4003468741030	348
7460130	RAMSES 746	4003468746028	348
7460131	RAMSES 746 RA	4003468746035	348
7480130	RAMSES 748	4003468748022	348
7480131	RAMSES 748 RA	4003468748039	348
7510131	RAMSES 751 RA	4003468751008	350
7820030	RAMSES 782	4003468782019	336
7840030	RAMSES 784	4003468784013	336
7840801	RAMSES 784 S	4003468784020	334
8119132	RAMSES 811 top2	4003468811139	324

Art.-No.	Type	GTIN	Page
8120132	RAMSES 812 top2	4003468812037	320
8120150	RAMSES 812 BLE	4003468810033	316
8139501	RAMSES 813 top2 HF Set 1	4003468813218	326
8139503	RAMSES 813 top2 HF Set A	4003468813164	326
8140150	RAMSES 814 BLE UP	4003468810040	317
8169132	RAMSES 816 top2 OT	4003468810002	330
8169150	RAMSES 816 BLE	4003468850244	318
8169151	RAMSES 816 BLE 2	4003468810057	318
8169152	RAMSES 816 BLE 3	4003468810064	318
8269210	VARIA 826 S WH KNX	4003468820049	108
8319132	RAMSES 831 top2	4003468831052	324
8320132	RAMSES 832 top2	4003468832035	320
8339501	RAMSES 833 top2 HF Set 1	4003468833049	328
8339502	RAMSES 833 top2 HF Set 2	4003468833056	328
8509150	RAMSES 850 BLE OT	4003468850237	323
8559201	KNX-OT-Box S	4003468850220	109
8569132	RAMSES 856 top2 OT	4003468850084	332
9070001	Front panel kit	4003468900109	352
9070041	Cover 55 x 55 for BZ	4003468902004	353
9070049	Wall mounting kit 70 mm	4003468900727	352
9070050	Wall mounting kit 52,5 mm	4003468900734	352
9070061	Terminal cover 52,5 mm	4003468900802	352
9070064	Wall mounting kit 35 mm	4003468900826	352
9070065	Wall mounting kit 17,5 mm	4003468900833	352
9070071	Snap-on mounting 72 x 72	4003468900895	352
9070074	Cover 72 x 72 for BZ	4003468900925	353
9070130	Bluetooth OBELISK top3	4003468902639	353
9070191	External temperature sensor 1	4003468901915	360
9070192	External temperature sensor 2	4003468901922	361
9070212	Adapter plate RAMSES 714	4003468900796	360
9070245	Adapter RAMSES 72x/78x	4003468902059	360
9070321	Temperature sensor	4003468903360	361
9070367	Diode module	4003468903605	360
9070371	Flow temperature sensor RAMSES	4003468903629	361
9070379	Plunge sensor RAMSES	4003468903711	361
9070397	Interface USB KNX	4003468903995	105
9070404	Memory card OBELISK top2	4003468904053	353
9070409	PC set OBELISK top2/3	4003468904015	352
9070410	Antenna RC-DCF	4003468904077	353
9070415	Digital surface-mounted light sensor	4003468904268	360
9070436	Valve adapter VA 78	4003468904220	362
9070437	Valve adapter VA 80	4003468904237	362
9070441	Actuator ALPHA 5 230 V	4003468901038	362
9070442	Actuator ALPHA 5 24 V	4003468901052	362
9070456	Digital flush-mounted light sensor	4003468904343	359
9070459	Temperature sensor RAMSES IP 65	4003468903810	361
9070463	External temperature sensor	4003468900871	361
9070480	Adapter plate RAMSES 70x	4003468904299	360
9070486	Adapter plate LUNA star	4003468907559	359
9070489	Temperature sensor	4003468902837	363
9070494	Power unit CO2-sensor	4003468904534	363
9070496	Flush-mounted temperature sensor	4003468905111	361
9070504	Surface frame LUXA 103-200	4003468904367	357
9070510	Cover frame PresenceLight 360 WH	7612748001275	354
9070513	Surface frame PresenceLight	7612748001145	354
9070523	RC filter	7612748001701	355
9070531	QuickSafe	7612748000582	355

Index 2021

Numerical 9070761 ... 9070992

Art.-No.	Type	GTIN	Page	Art.-No.	Type	GTIN	Page
9070591	Cover 110 GR	4003468905234	355	9070929	DALI-Gateway KNX plus	4003468902394	74
9070594	Cover 85 GR	4003468905265	355	9070956	PS 160 mA T KNX	4003468902271	106
9070597	Cover FLAT 85 GR	4003468905296	355	9070957	PS 320 mA T KNX	4003468902288	106
9070601	Central part RAMSES 746	4003468904572	362	9070958	PS 640 mA T KNX	4003468902295	106
9070602	Central part RAMSES 741/748	4003468904589	362	9070969	Corner angle 10 WH	4003468901700	356
9070603	Frame RAMSES 74x	4003468904596	362	9070970	Corner angle 10 AL	4003468901717	356
9070605	Socket RAMSES	4003468904657	360	9070971	Spacer 10 WH	4003468901724	357
9070627	Cover frame PresenceLight 180 SR	7612748001664	354	9070972	Spacer 10 AL	4003468901830	356
9070628	Cover frame PresenceLight 180 BK	7612748001640	354	9070974	Corner angle theLuxa E WH	4003468901939	355
9070629	Cover frame PresenceLight 180 WH	7612748001886	354	9070975	Corner angle theLuxa E BK	4003468900994	355
9070631	Cover frame PresenceLight 360 SR	7612748001251	354	9070977	PlanoCover 76 BK	7612748006140	355
9070632	Cover frame PresenceLight 360 BK	7612748001237	354	9070978	PlanoCover 76 SR	7612748006157	355
9070634	Surface frame PresenceLight BK	7612748001176	354	9070985	theSenda B	4003468902073	359
9070712	OT-Box Standard	4003468904763	361	9070986	Surface frame LUXA 103-100 U	4003468902080	357
9070754	Cover 45A BJRE WH	4003468905593	357	9070987	Corner angle 10 BK	4003468902110	356
9070760	Motion module theLeda B WH	4003468902738	358	9070988	Spacer 10 BK	4003468902707	357
9070761	Motion module theLeda B BK	4003468902745	358	9070990	Flush-mounted light sensor plus	4003468902226	359
9070762	Light module theLeda B WH	4003468902752	358	9070991	Surface-mounted light sensor plus	4003468902332	359
9070763	Light module theLeda B BK	4003468902769	358	9070992	Ceiling installation box 68A	4003468905180	354
9070765	Spike theLeda D B	4003468903278	358				
9070770	IPsecure Router KNX	4003468902929	104				
9070771	IPsecure Interface KNX	4003468902998	104				
9070788	Cover 45A BJBSI WH	4003468904978	357				
9070789	Cover 45A JAS WH	4003468904985	357				
9070790	Cover 45A MMP WH	4003468904992	357				
9070791	Cover 45A GS WH	4003468905005	357				
9070792	Cover 45A BS WH	4003468905012	357				
9070793	LUNA star adapter mast fixing	4003468905029	359				
9070796	Surface frame 75B WH	4003468905043	355				
9070800	theLeda B Motion Module RC WH	4003468905074	358				
9070801	theLeda B Motion Module RC BK	4003468905081	358				
9070806	2-way mounting plate ION	4003468905203	363				
9070807	Antenna RC-GNSS R	4003468905210	353				
9070822	4-way push button module	4003468905173	363				
9070823	Antenna RC-GNSS	4003468905357	353				
9070824	Surface frame 75B BK	4003468905364	355				
9070825	Compensation module LED	4003468905371	353				
9070868	Media coupler TP-RF KNX	4003468905036	80				
9070880	Line coupler S KNX	4003468900253	105				
9070900	Set basic KNX AP Multi WH	4003468905395	88				
9070902	Corner angle theLuxa S WH	4003468900277	356				
9070903	Corner angle theLuxa S BK	4003468900284	356				
9070904	Corner angle theLuxa P WH	4003468900291	356				
9070905	Corner angle theLuxa P BK	4003468900314	356				
9070906	Spacer theLuxa S WH	4003468900338	355				
9070907	Spacer theLuxa S BK	4003468900345	355				
9070908	Spacer theLuxa P WH	4003468900413	356				
9070909	Spacer theLuxa P BK	4003468900420	356				
9070910	theSenda P	4003468900475	359				
9070911	theSenda S	4003468900505	359				
9070912	Surface frame 110A WH	7612748004900	354				
9070913	Surface frame 110A GR	7612748004917	354				
9070918	Surface frame 110B WH	7612748005464	354				
9070919	Surface frame 110B GR	7612748005471	354				
9070921	Masking clip	7612748005495	355				
9070928	Mast mounting S	4003468901687	363				

Type	Art.-No.	Type	Art.-No.
Discontinued model		Successor	
theMova S360-100 DE GR	1030561	theMova S360-100 DE WH + Cover 85 GR	1030560 + 9070594
theMova S360-101 DE GR	1030566	theMova S360-101 DE WH + Cover 85 GR	1030565 + 9070594
theMova P360-100 UP GR	1030601	theMova P360-100 UP WH + Cover 110 GR	1030600 + 9070591
SPHINX 104-360/2 DIMplus	1040374	-	No successor
LUNA 129 star-time	1290700	-	No successor
LUNA 131 DDC	1319700	-	No successor
Meteodata 139 KNX	1399200	-	No successor
compact office DIM	2010001	-	No successor
thePassa P360-101 UP GR	2010301	thePassa P360-101 UP WH + Cover 110 GR	2010300 + 9070591
thePassa P360 Slave UP GR	2010331	thePassa P360 Slave UP WH + Cover 110 GR	2010330 + 9070591
thePassa P360-221 DALI UP GR	2010341	thePassa P360-221 DALI UP WH + Cover 110 GR	2010340 + 9070591
thePassa P360 KNX UP GR	2019301	thePassa P360 KNX UP WH + Cover 110 GR	2019300 + 9070591
PlanoSpot 360 DALI DE WH	2030110	PlanoSpot 360 DALI-2 S DE WH	2030190
PlanoCentro EWH-A KNX	2059102	PlanoSpot 360 KNX DE WH	2039100
PlanoCentro UWH-A KNX	2059202	PlanoSpot 360 KNX DE WH	2039100
theRonda P360-100 M UP GR	2080021	theRonda P360-100 M UP WH + Cover 110 GR	2080020 + 9070591
theRonda P360-101 M UP GR	2080026	theRonda P360-101 M UP WH + Cover 110 GR	2080025 + 9070591
theRonda P360 Slave UP GR	2080031	theRonda P360 Slave UP WH + Cover 110 GR	2080030 + 9070591
theRonda P360-110 DALI UP GR	2080041	theRonda P360-110 DALI UP WH + Cover 110 GR	2080040 + 9070591
theRonda S360-100 UP GR	2080521	theRonda S360-100 UP WH + Cover 110 GR	2080520 + 9070591
theRonda S360-101 UP GR	2080526	theRonda S360-101 UP WH + Cover 110 GR	2080525 + 9070591
theRonda S360 Slave UP GR	2080531	theRonda S360 Slave UP WH + Cover 110 GR	2080530 + 9070591
theRonda S360-100 DE GR	2080561	theRonda S360-100 DE WH + Cover 85 GR	2080560 + 9070594
theRonda S360-101 DE GR	2080566	theRonda S360-101 DE WH + Cover 85 GR	2080565 + 9070594
theRonda P360 KNX UP GR	2089001	theRonda P360 KNX UP WH + Cover 110 GR	2089000 + 9070591
theRonda S360 KNX FLAT DE GR	2089561	theRonda S360 KNX FLAT DE WH + Cover FLAT 85 GR	2089560 + 9070597
LUXOR 400	4000000	Smart Home System LUXORliving	-
LUXOR 402	4020000	Smart Home System LUXORliving	-
LUXOR 404	4040000	Smart Home System LUXORliving	-
LUXOR 405 S	4050100	Smart Home System LUXORliving	-
LUXOR 408 S	4080100	Smart Home System LUXORliving	-
LUXOR 409 S	4090100	Smart Home System LUXORliving	-
LUXOR 411	4110000	Smart Home System LUXORliving	-
LUXOR 426	4260000	Smart Home System LUXORliving	-
LUXOR 440	4400000	Smart Home System LUXORliving	-
LUXOR Set 5	4990005	Smart Home System LUXORliving	-
ZS 600 DCF KNX	6009200	-	No successor
theServa S110	8254100	-	No successor
Antenne DCF77 KNX	9070271	-	No successor
AP-Rahmen compact	9070514	-	No successor
Antenne top2 RC-GPS	9070610	Antenne RC-GNSS	9070823
AP-Rahmen compact BK	9070637	-	No successor
AP-Rahmen compact SR	9070638	-	No successor
PlanoCover E-112x112	9070677	-	No successor
PlanoCover U-123x123	9070680	-	No successor
PlanoBox 1WH	9070731	-	No successor
PlanoBox 1BK	9070732	-	No successor
PlanoBox 1SR	9070733	-	No successor
PlanoBox 1EL	9070735	-	No successor
PlanoSet RQ EWH	9070736	-	No successor
PlanoSet RQ EBK	9070737	-	No successor
PlanoSet RQ ESR	9070738	-	No successor
PlanoSet RR EWH	9070740	-	No successor
PlanoSet RR EBK	9070741	-	No successor
PlanoSet RR ESR	9070742	-	No successor
Schwenkhalterung theLeda EC WH	9070758	-	No successor
Schwenkhalterung theLeda EC BK	9070759	-	No successor
Decken-Einbaudose 73A	9070917	Decken-Einbaudose 68A	9070992
IP Router KNX	9070980	IPsecure Router KNX	9070770
IP Schnittstelle KNX	9070981	IPsecure Interface KNX	9070771

Theben AG

Packaging units

For the optimization of your logistical processes, we offer you the following packaging units in addition to individual packages:

Art.-No.	Type	Number Unit 1	Number Unit 2
0010002	ELPA 1	10	
0030002	ELPA 3	10	
0060002	ELPA 6	10	
0060003	ELPA 6 plus	10	
0080002	ELPA 8	10	300
0090001	ELPA 9	10	
0200000	theben-eltimo 020 S	5	
0200300	theben-eltimo 020 S DCF	5	
0260030	theben-timer 26	10	
0260855	theben-timer 26 IP 44	5	
0270930	theben-timer 27	10	
0300130	TR 030 top3 UP	30	
0700130	SELEKTA 070 top3 UP	30	
0770802	FRI 77 h-2	5	
0770832	FRI 77 g-2	5	
1010200	theLuxe R180 WH	48	
1010201	theLuxe R180 BK	48	
1010500	theLuxe S150 WH	24	
1010501	theLuxe S150 BK	24	
1010505	theLuxe S180 WH	24	
1010506	theLuxe S180 BK	24	
1010510	theLuxe S360 WH	24	
1010511	theLuxe S360 BK	24	
1010605	theLuxe P220 WH	18	
1010606	theLuxe P220 BK	18	
1010610	theLuxe P300 WH	18	
1019610	theLuxe P300 KNX WH	18	
1019611	theLuxe P300 KNX BK	18	
1020681	theLeda B100L WH	6	
1020682	theLeda B100L BK	6	
1020683	theLeda B20L WH	12	
1020684	theLeda B20L BK	12	
1020685	theLeda B30L WH	6	
1020686	theLeda B30L BK	6	
1020687	theLeda B50L WH	6	
1020688	theLeda B50L BK	6	
1020701	theLeda D SL AL	16	
1020702	theLeda D SUL AL	16	
1020703	theLeda D UL AL	16	
1020704	theLeda D UDL AL	8	
1020705	theLeda D BL AL	6	
1020706	theLeda D BL plus AL	4	
1020721	theLeda S10L WH	24	
1020722	theLeda S10L BK	24	
1020723	theLeda S20L WH	16	
1020724	theLeda S20L BK	16	
1020741	theLeda P12L WH	8	
1020742	theLeda P12L AL	8	
1020743	theLeda P24L WH	8	
1020744	theLeda P24L AL	8	
1020901	theLeda D S AL	16	
1020902	theLeda D SU AL	16	
1020903	theLeda D U AL	16	
1020904	theLeda D UD AL	8	
1020905	theLeda D B AL	6	
1020906	theLeda D B plus AL	4	
1020907	theLeda D B plus S AL	4	

Art.-No.	Type	Number Unit 1	Number Unit 2
1020921	theLeda S10 WH	24	
1020922	theLeda S10 BK	24	
1020923	theLeda S20 WH	16	
1020924	theLeda S20 BK	16	
1020931	theLeda S10 W WH	24	
1020932	theLeda S10 W BK	24	
1020933	theLeda S20 W WH	16	
1020934	theLeda S20 W BK	16	
1020941	theLeda P12 WH	8	
1020942	theLeda P12 AL	8	
1020943	theLeda P24 WH	8	
1020944	theLeda P24 AL	8	
1030031	LUXA 103-200 T	60	
1030045	LUXA 103-100 UA WH	24	
1030540	theMova S360-100 FLAT DE WH	72	
1030545	theMova S360-101 FLAT DE WH	72	
1030550	theMova S360-100 AP WH	60	
1030551	theMova S360-100 AP GR	60	
1030555	theMova S360-101 AP WH	60	
1030556	theMova S360-101 AP GR	60	
1030560	theMova S360-100 DE WH	72	
1030565	theMova S360-101 DE WH	72	
1030600	theMova P360-100 UP WH	60	
1260901	LUNA 126 star	40	
1420721	BZ 142-1	10	
1510011	SYN 151 h	5	
1600001	SYN 160 a	10	
1610011	SYN 161 d	5	100
1690801	SYN 169 s	5	
1700130	SELEKTA 170 top3	100	
1710330	SELEKTA 171 top3 RC	100	
1720130	SELEKTA 172 top3	100	
1720330	SELEKTA 172 top3 RC	100	
1740130	SELEKTA 174 top3	100	
1790008	TM 179 h	5	
1800001	SUL 180 a	10	
1810011	SUL 181 d	5	100
1880108	SUL 188 hw	5	
1890108	SUL 189 hw	5	
1890801	SUL 189 s	5	
1891801	SUL 189 s 110V	5	
1900001	MEM 190 a	10	
1910011	SUL 191 w	5	
2000050	PräsenzLight 180	45	
2009000	PresenceLight 360B-KNX WH	45	
2009050	PresenceLight 180B-KNX WH	45	
2010300	thePassa P360-101 UP WH	60	
2010330	thePassa P360 SLAVE UP WH	60	
2010340	thePassa P360-221 DALI UP WH	60	
2019300	thePassa P360 KNX UP WH	60	
2030190	PlanoSpot 360 DALI-2 S DE WH	72	
2039100	PlanoSpot 360 KNX DE WH	72	
2060650	theMura S180-100 UP WH	60	
2060655	theMura S180-101 UP WH	60	
2060750	theMura S180-100 B UP	60	
2060755	theMura S180-101 B UP	60	
2060760	theMura S180 Slave B UP	60	

Art.-No.	Type	Number Unit 1	Number Unit 2
2060770	theMura S180-100 2W B UP	60	
2070105	thePrema P360-101 E UP WH	60	
2070106	thePrema P360-101 E UP GR	60	
2070130	thePrema P360 Slave E UP WH	60	
2070131	thePrema P360 Slave E UP GR	60	
2070525	thePrema S360 DALI UP WH	60	
2070600	thePrema S360-100 E UP WH	60	
2070601	thePrema S360-100 E UP GR	60	
2070605	thePrema S360-101 E UP WH	60	
2070606	thePrema S360-101 E UP GR	60	
2070630	thePrema S360 Slave E UP WH	60	
2070631	thePrema S360 Slave E UP GR	60	
2079000	thePrema P360 KNX UP WH	60	
2079001	thePrema P360 KNX UP GR	60	
2079500	thePrema S360 KNX UP WH	60	
2079501	thePrema S360 KNX UP GR	60	
2080020	theRonda P360-100 M UP WH	60	
2080025	theRonda P360-101 M UP WH	60	
2080030	theRonda P360 Slave UP WH	60	
2080040	theRonda P360-110 DALI UP WH	60	
2080045	theRonda P360-330 DALI UP WH	60	
2080520	theRonda S360-100 UP WH	60	
2080525	theRonda S360-101 UP WH	60	
2080530	theRonda S360 Slave UP WH	60	
2080540	theRonda S360-100 FLAT DE WH	72	
2080545	theRonda S360-101 FLAT DE WH	72	
2080550	theRonda S360-100 AP WH	60	
2080555	theRonda S360-101 AP WH	60	
2080560	theRonda S360-100 DE WH	72	
2080565	theRonda S360-101 DE WH	72	
2080580	theRonda S360-110 DALI UP WH	60	
2089000	theRonda P360 KNX UP WH	60	
2690008	SYN 269 h	5	
4800640	LUXORliving H1 RF	40	
4930279	DMB 1 T KNX	40	
5320001	DIMAX 532 plus	40	
5340001	DIMAX 534 plus	5	
6100130	TR 610 top3	100	
6110130	TR 611 top3	100	
6110330	TR 611 top3 RC	100	
6120130	TR 612 top3	100	
6220130	TR 622 top3	100	
7010001	RAMSES 701	10	
7020001	RAMSES 702	10	
7030001	RAMSES 703	10	
7040001	RAMSES 704	10	
7050001	RAMSES 705	10	
7060001	RAMSES 706	10	
7070001	RAMSES 707	10	
7080001	RAMSES 708	10	
7090001	RAMSES 709	10	
7150002	SOTHS 715	5	
7410130	RAMSES 741	5	
7460130	RAMSES 746	5	
7480130	RAMSES 748	5	
9070504	AP-Rahmen LUXA 103-200	90	
9070510	Abdeckrahmen PräsenzLight 360 WH	10	

Art.-No.	Type	Number Unit 1	Number Unit 2
9070513	AP-Rahmen PräsenzLight	5	
9070627	Abdeckrahmen PräsenzLight 180 SR	10	
9070628	Abdeckrahmen PräsenzLight 180 BK	10	
9070629	Abdeckrahmen PräsenzLight 180 WH	10	
9070760	theLeda B Motion Module WH	36	
9070761	theLeda B Motion Module BK	36	
9070762	theLeda B Light Module WH	64	
9070763	theLeda B Light Module BK	64	
9070765	Erdspieß theLeda D	12	
9070786	Ausgleichsrahmen 45A FED WH	126	
9070787	Abdeckung 45A LM WH	54	
9070788	Ausgleichsrahmen 45A BJSI WH	126	
9070789	Ausgleichsrahmen 45A JAS WH	126	
9070790	Ausgleichsrahmen 45A MMP WH	126	
9070791	Ausgleichsrahmen 45A GS WH	126	
9070792	Ausgleichsrahmen 45A BS WH	126	
9070798	Abdeckung 45A Theben WH	126	
9070800	theLeda B Motion Module RC WH	36	
9070801	theLeda B Motion Module RC BK	36	
9070802	theLeda B Remote control	10	
9070806	Tastermodul 4-fach	63	
9070902	Eckwinkel theLuxa S WH	96	
9070903	Eckwinkel theLuxa S BK	96	
9070904	Eckwinkel theLuxa P WH	96	
9070905	Eckwinkel theLuxa P BK	96	
9070906	Abstandsrahmen theLuxa S WH	156	
9070907	Abstandsrahmen theLuxa S BK	156	
9070908	Abstandsrahmen theLuxa P WH	168	
9070909	Abstandsrahmen theLuxa P BK	168	
9070910	theSenda P	80	
9070911	theSenda S	80	
9070969	Eckwinkel 10 WH	96	
9070970	Eckwinkel 10 AL	96	
9070971	Abstandsrahmen 10 WH	168	
9070972	Abstandsrahmen 10 AL	168	
9070985	theSenda B	80	
9070986	AP-Rahmen LUXA 103-100 U	54	
9070987	Eckwinkel 10 BK	96	
9070988	Abstandsrahmen 10 BK	168	

Imprint

Client: Theben AG, Haigerloch
Product data manager: Arne Mohl
Realisation: Theben AG, Haigerloch
Layout: Theben AG
Picture sources: Theben AG, Detlef Majer



Theben AG

General Delivery and Sales Conditions

For use with companies (status 2016-09-01)

Preamble

All deliveries and services are based - also in the future - exclusively on the following conditions, even if we do not refer to them specifically in the individual case. Their validity can only be partly or totally excluded by express written agreement for an individual transaction. General terms and conditions, especially purchase conditions of the purchaser, shall not apply to our deliveries and services. We shall not be bound by these terms and conditions even if we do not object to them expressly in an individual case; we herewith object to them. Our General Delivery and Sales Conditions are regarded as accepted, at the latest with the acceptance of the goods or the service.

I. SCOPE OF DELIVERY OBLIGATIONS

1. Our offers are non-binding, even if made on the purchaser's request. A legally binding contractual relationship with the purchaser shall only be constituted once we have confirmed the order in writing, which may also be possible by fax, by letters created automatically without signature, or e-mail; the same applies to modifications or amendments to the contract. As far as scope, type and time of the delivery are concerned, our written order confirmation shall be binding.

2. We reserve the right to any modifications of construction, production and design of our products. Our catalogues and our product presentations published on the Internet are continually being updated. Any illustrations and drawings contained therein shall not be binding and shall not be part of the properties agreed upon. They neither represent any guarantee for durability nor quality.

3. The documents belonging to the offer, such as drawings, data sheets, figures, diagrams, files, etc., shall only be approximates where not expressly described as being binding. The documents shall remain our property; we reserve all rights to them. Without our written consent, they must not be disclosed to any third party and they must be returned to us at any time on request.

4. Call orders must be placed and accepted in due time and with the partial quantities agreed. In case of call orders where term, production batch quantities and release times have not been agreed, we shall be entitled to request a binding definition of the releases 3 months after the date of the order confirmation, at the latest. If the purchaser does not comply with this request within 3 weeks, we shall be entitled to grant him a last additional period of two weeks for doing so and when this additional period has lapsed as well, we shall be entitled to withdraw from the contract or to refuse delivery and claim damages. In any case, the entire quantity ordered in the call order has to be accepted and to be paid by the purchaser 18 months after the order, except when otherwise stipulated. If the contractual quantity should be exceeded by the individual calls, we shall be entitled to deliver the surplus, but not obligated to do so. We can charge for the excess at the prices valid at the time of the call or the delivery.

II. PRICE

1. All prices are quoted in EURO. The applicable value added tax shall be charged separately.

2. The prices quoted apply to delivery ex works, without insurance and packaging.

3. Surcharges and a recalculation of the agreed remuneration shall be admissible as far as they are necessitated by the circumstances, e.g. material costs, wage or energy cost increases, an increase of the public charges etc., and if the goods or services are to be provided later than 4 months after the contract date. In case of any other price increases, the purchaser shall be entitled to withdraw from the contract if the list price has been increased far more than the general costs of living. Any deliveries for subsequent orders that are placed after the date of the price adjustment shall be charged at the new prices without the purchaser being entitled to withdraw from the contract.

III. DELIVERY

1. The delivery term shall start with the dispatch of the order confirmation, but not before all details of the perfor-

mance of the order have been clarified and not before receipt of an agreed advance payment or provision of material; the delivery terms are always stated by us subject to our own supply by our suppliers. The delivery term shall be deemed to have been complied with when the delivery item has been dispatched or collected before the expiration of this term or when a ready-for-dispatch note has been issued in cases where the goods could not be dispatched or collected without our being responsible for this.

2. In case of force majeure or other events beyond our responsibility that would threaten the smooth processing of the order, in particular delivery delays of our suppliers, disturbances of traffic or operation, industrial disputes, shortage of materials or energy, we shall be entitled to withdraw, entirely or partially, from the contract or to postpone delivery without the purchaser being entitled to claim damages. The purchaser may request from us a statement specifying whether we want to withdraw or whether we want to fulfil the contract within an adequate period of time. If we do not make such a statement, the purchaser shall be entitled to withdraw from the contract. We shall not be liable for the events or circumstances referred to above even if they occur during an existing delay of delivery.

3. In case of a delivery delay for which we are responsible, the purchaser shall grant us an adequate grace period. Once this period has expired, the purchaser may claim damages and/or withdraw from the contract insofar as the goods have not been delivered or indicated as being ready for dispatch until the end of this period. The purchaser is not entitled to withdraw from the contract if delivery delay has not been caused by us.

4. The purchaser is only entitled to claim damages as a replacement for the services if the cause of the damage is based on intent or gross negligence on our part. This does not apply if it is a firm deal.

5. The delivery obligations and the delivery terms shall be suspended as long as the purchaser is in delay with acceptance of the goods or any other obligation, without our rights from the purchaser's delay being thereby affected, or without him exceeding the credit limit granted by us. In this case, the risk of accidental loss or accidental deterioration shall pass to the purchaser from the date he is in delay.

6. The delivery term originally agreed shall no longer apply if the order is modified with our written consent.

7. Adequate partial deliveries as well as deviations from the order quantities (max. +/- 5 %) shall be admissible if the purchaser can be reasonably expected to accept this and as long as the latter's interests are taken into account.

8. The weight and the number of pieces of the goods delivered determined by us shall be decisive for the invoicing.

IV. DISPATCH

1. The goods shall be dispatched at the purchaser's costs and risk from a location to be determined by us.

2. Unless the purchaser has submitted any special requests, we shall choose, at our own discretion, the packaging, as well as type and channel of dispatch. The additional costs for special wishes of the purchaser shall be borne by the latter. We shall not be obliged to choose the cheapest type of dispatch.

3. If the dispatch or the delivery is delayed upon the purchaser's request, we shall be entitled to set him an adequate period of time for accepting the goods and to demand immediate acceptance as well as a compensation for the damage caused by the delay once this period has lapsed.

V. TERMS OF PAYMENT

1. Payments shall be made in accordance with the conditions specified in our order confirmation.

2. The purchaser bears the costs for his payment, especially all kinds of banking charges and expenses.

3. Cheques shall be accepted only with the usual proviso. With any type of payment, the settlement date shall be the

day on which we can dispose over the amount due.

4. If a deferment of payment is granted or if the purchaser is in default with his obligations to pay, he shall, in the meantime, be liable to pay interests of 9 percent above the respective basic interest rate, without the need for a reminder notice. We reserve the right to claim further damages due to the delay. The purchaser reserves the right to prove that lower damages have been incurred. Furthermore, we are entitled to charge the purchaser a fixed rate of € 40.00 for the reminder.

5. The purchaser shall not be entitled to offset payments against any counter claims or rights unless his claims or rights are acknowledged by us, uncontested or final and absolute. The purchaser is not entitled to retain payments on account of disputed counterclaims either.

6. All our claims are due immediately if terms of payment are not adhered to, or we become aware of circumstances which appear to impair the creditworthiness of the purchaser. In this case, we are also entitled to supply outstanding consignments on cash-in-advance terms or security deposit, or to withdraw from the contract after a reasonable grace period and/or claim damages for non-fulfilment. In addition, we may prohibit the resale or processing of the goods delivered and request that the purchaser, at his costs, return the goods to us or assign the indirect possession of the goods delivered, and withdraw the authorization to collect claims pursuant to Section IX. 7. Already now, the purchaser agrees that we shall, in the mentioned cases, be authorized to enter into his premises and to take away the goods delivered.

7. Payments shall generally be set off against the oldest invoice that is due for payment. As long as an older invoice has not been paid, the purchaser is not entitled to discount on later invoices.

VI. COMPLAINTS AND NOTICES OF DEFECT

1. Complaints because of incomplete or incorrect delivery or notices of evident defects must be delivered to us in writing immediately, at the latest, however, within 2 weeks after receipt of the goods. Any other defects must be reported to us in writing immediately, at the latest, however, within 2 weeks after they have been detected. If we have not received the complaint or notice of defect in due time, any warranty claims of the purchaser shall be excluded. In case of defects reported in due time, the purchaser shall be entitled to the claims according to Section VII.

2. In case of damage in transit, the purchaser must procure an ascertainment of the damage by the railroad company, the postal service or the transport company.

3. If a part of the goods delivered is defective, the purchaser shall not be entitled to reject the entire delivery, unless the partial delivery is of no interest to the purchaser.

VII. WARRANTY

1. The purchaser's claims for supplementary performance shall be time-barred within 12 months from the statutory start of the limitation period. The same applies for withdrawal and diminution. This time limit does not apply if:

- the law according to § 438 section 1 no. 2 BGB and § 634a section 1 no. 2 BGB requires longer time periods,
- in case of intent,
- in case of fraudulent concealment, and
- in case of non-compliance with a quality guarantee.

We shall be obliged, at our option, to eliminate any defects or make a replacement delivery if the delivery items are defective. The purchaser's reimbursement claims for expenses according to § 445a BGB shall also be time-barred within 12 months from the statutory start of the limitation period, provided that the last contract in the supply chain is not a consumer goods purchase. Any legal provisions regarding suspension of expiration, suspension and recommencement of the limitation period remain unaffected. Reimbursement claims against us according to § 445a BGB are only valid if the purchaser has not made an agreement with his customer which goes beyond the statutory claims for defects.

2. The purchaser shall grant us the time and opportunity that, in our equitable discretion, is required for the elimination of the defects. Any parts that are replaced shall become our property.

3. If the supplementary performance fails, if we let the adequate period granted to us for this purpose expire without making a new delivery or without eliminating the defect, or if subsequent performance is impossible or refused by us, the purchaser shall be entitled to withdraw from the contract or demand a reduction of the purchase price, the same shall apply to cases where we are unable to provide supplementary performance.

4. The warranty shall neither apply to defects and/or damage due to normal wear and tear nor defects and/or damage caused by inappropriate or negligent use, excessive stress, improper use, wrong handling etc. or circumstances that are not provided for in the contract unless the damage is due to our fault.

5. Without our consent, warranty claims may not be assigned to any third party.

6. We shall not be liable for any defects caused by improper modifications or repairs that are carried out by the purchaser or a third party.

7. Our liability for essential third-party products shall be restricted to the assignment of the warranty claims we are entitled to from the supplier of the third-party product unless satisfaction from the assigned right fails or the assigned claim cannot be enforced for any other reasons.

8. Unless otherwise provided below, any further claims of the purchaser against us, irrespective of the legal cause thereof, shall be excluded, in particular claims for the compensation of a damage that does not exist and/or occur in the goods delivered themselves (e.g. loss of profit, consequential damage or other economic losses); this exemption from liability shall not apply if liability is required by law because of deliberate action, gross negligence or a promise of guarantee or if an essential contractual obligation has been violated or in case of injuries to life and limb or health.

In case of negligent, but not grossly negligent violation, our liability shall be restricted to the replacement of the typical foreseeable damage.

9. The above provisions shall apply accordingly to the delivery of other goods than those agreed upon in the contract.

VIII. LIABILITY, PERIOD OF LIMITATION

1. The exclusion and the limitations of our liability for damages as set forth in Section VII. 8 shall apply accordingly to all cases of our liability for damages due to violation of contractual, or quasi-contractual obligations and tortious act. They shall not apply to claims pursuant to Paragraphs 1 and 4 of the Product Liability Law and to claims due to initial inability to perform at the point of conclusion of the contract or impossibility for which we are responsible. This exemption from liability shall not apply if liability is required by law because of deliberate action, gross negligence or a promise of guarantee or if an essential contractual obligation has been violated or in case of injuries to life and limb or health.

2. If our liability for damages is excluded or restricted, this shall apply in the same way to the personal liability of our executive bodies, employees or authorized agents.

3. The claims of the purchaser referred to in Sec. 1 shall become time-barred after 24 months, calculated from the end of the year of the passing of the risk. If the statutory period of limitation is shorter than 24 months, this statutory period shall be applicable to the relevant claims on the part of the purchaser. This reduction of the period of limitation shall not apply to claims for reasons of tortious act or product liability.

4. The statutory provisions concerning the burden of proof shall remain unaffected.

IX. RETENTION OF TITLE

1. All goods delivered (goods subject to retention of title) shall remain our property until all and any claims to which we are entitled because of the business relationship, in particular the outstanding balance claims, have been fully settled by the purchaser. This shall also apply when payments are made on specially designated claims.

2. If the goods subject to retention of title are combined with other goods by the purchaser, we shall acquire co-ownership of the new object pro rata of the invoice value of the goods subject to retention of title to the invoice value of the other goods used. If our ownership lapses due to a combination, the purchaser herewith agrees to assign to us his property rights to the new objects to the amount of the invoice value of the goods subject to retention of title and keeps them for us, free of charge. The resulting co-ownership rights shall be considered as goods subject to retention of title within the meaning of Section 1. We accept the assignment.

3. The purchaser may sell the goods subject to retention of title in the normal course of business at his terms and conditions only if these contain a comprehensive retention of title in accordance with the provisions set forth herein, and as long as he is not in default, provided that the claims from the resale pass to us pursuant to Sections 4. and 6. hereof. The purchaser does not have any other right of disposition of the goods subject to retention of title, in particular the authorisation to dispose of the goods subject to retention of title shall be automatically revoked if insolvency proceedings are applied for or liquidation commenced regarding the assets of the purchaser

4. The claims of the purchaser from reselling the goods subject to retention of title are herewith assigned to us. They serve as security to the same extent as the goods subject to retention of title. We herewith accept the assignment.

5. If the purchaser sells the goods subject to retention of title together with other goods not obtained from us, the assignment of claims from the resale shall only correspond to the amount of the invoice value of the goods subject to retention of title that are sold in the individual case. When goods in which we have a co-ownership share pursuant to Sec. 2. are sold, the claims shall be deemed to have been assigned corresponding to the value of this co-ownership shares.

6. If the purchaser uses the goods subject to retention of title for the execution of a contract for work, Sections 4. and 5. shall apply accordingly to the claims from this contract.

7. The purchaser shall be entitled to collect claims from sales according to Sections 3., 5., and 6. until this permission is revoked by us, which shall be admissible at any time. We will only make use of the right of revocation in the cases specified in Section 3., as well as V. 5. Any other assignment of the claims by the purchaser shall not be permitted. Upon our request, the purchaser shall be obliged to inform his customers immediately about this assignment to us – unless we do it ourselves – and to provide any information and documents required for the collection of claims to us. The purchaser is prohibited from hypothecation or transfer of the goods by way of security.

8. Our retention of title implies that, once all our claims have been fully paid, the title to the goods subject to retention of title shall ipso jure pass to the purchaser and he shall be entitled to the assigned claims without any restrictions. If the value of the existing securities exceeds the secured claims by more than 20 % in total, we shall be obliged to release securities accordingly, at our option, on request of the purchaser. The assessment of securities shall be based on their realizable value.

9. The purchaser shall inform us immediately about any seizure or any other threat or impairment to our ownership rights or claims by a third party and provide the bailiff's return or any other documents to us and he shall do anything within his power to protect our rights.

10. We shall be entitled at any time to enter into the warehouse and the business premises of the purchaser, in order to remove, separate or label the goods subject to retention of title. At our request, the purchaser shall provide any relevant information concerning the goods subject to retention of title and hand over the related documents. The purchaser, at his costs, shall be obliged to provide comprehensive insurance coverage for the goods subject to retention of title in our favour and to supply evidence thereof on request. He herewith assigns all claims from these insurances to us; we accept the assignment.

11. The assertion of our retention of title or the revocation of the authorizations granted herein shall not be considered as a withdrawal from the contract. The purchaser's right of possession in the goods subject to retention of title expires if he does not meet his obligations arising from this or another contract. We shall then be entitled to take possession of the goods subject to retention of title ourselves and to exploit them in the best possible way by means of a private sale or an auction, without prejudice to the payment obligations or any other duties of the purchaser. The proceeds thus realized shall be appropriated to the purchaser's outstanding payments after the costs have been deducted. Should there be any surplus, this shall be paid to the purchaser.

12. If the retention of title or the assignment is not effective under the law to which the goods belong, the corresponding security valid in this field of law shall be deemed as agreed. If the cooperation of the purchaser is required in this context, he shall take any measures that are necessary for the constitution and preservation of such rights.

X. TOOLS

1. Tools, moulds, appliances and the like - in the following referred to as "tools" - are in principle our assets, even if the purchaser had paid for these wholly or partially. This shall apply irrespective of whether the tools were manufactured by us or by commissioned third parties.

2. We undertake not to manufacture any parts for third parties using tools for which the purchaser has paid the entire cost, providing the purchaser supplies us with follow-up orders. This obligation expires without a claim for reimbursement of any type against us arising for the purchaser if we do not receive further orders within two years after the last order.

3. We shall store the tools in good condition free of charge. The purchaser shall bear the costs of maintenance and repairs. Our obligation to store the tools shall come to an end after expiry of the two-year period stated in Sec. 2. We shall be entitled to dispose of the tools afterwards.

4. The provisions above (Sections 1 to 3) shall not apply to tools for common and generally usable items.

XI. PROTECTIVE RIGHTS OF THIRD PARTIES

Insofar as we have to manufacture products on the basis of drawings, specifications, models, or samples given to us by the purchaser, the purchaser takes upon himself the responsibility of guaranteeing to us that the rights of third parties are not infringed upon. In case of violation, the purchaser will indemnify us in full from any claims by third parties and fully reimburse us for any resulting damages. If a third party claims its industrial property rights we are entitled to stop the manufacturing or delivering of the items immediately without checking the legal situation.

XII. MISCELLANEOUS PROVISIONS

1. The place of performance and jurisdiction for both parties under the contract is D-72401 Haigerloch, Germany. We are also entitled to file an action against the purchaser at the purchaser's general place of jurisdiction.

2. All legal relations between the purchaser and us shall be governed exclusively by law of the Federal Republic of Germany.

3. Should one or several of the provisions of these terms and conditions or the other contractual provisions be or become invalid, this shall not affect the validity of the remaining provisions. The invalid provisions shall be reinterpreted in such a way that the legal and economic purpose intended with them is achieved to the greatest possible extent. The same shall apply if, during the execution of the agreement, a gap in the agreement requiring an amendment becomes evident. The contracting parties undertake to replace the ineffective provisions immediately by legally valid provisions or to close the contractual gap.

4. We shall store the purchaser's data for the purposes of the contractual relationship.



Theben Worldwide

Headquarter | Theben Group Companies

Headquarter

Theben AG

Hohenbergstr. 32
D-72401 Haigerloch, GERMANY
Phone +49 7474 692-0
Fax +49 7474 692-150
info@theben.de
www.theben.de

Theben Group Companies

AUSTRIA

Theben AG AT

Resselstraße 16
2120 Wolkersdorf
Phone +43 667 796 84 44
eric-rainer.schoenbauer@theben.de
www.theben.de

AUSTRALIA

Theben PTY LTD

Unit 1 / 14 Drury Terrace
5042 Clovelly Park, South Australia
Phone +61 8 8463 1163
Fax +61 8 8464 0277
sales@thebenpty.com.au
www.theben.de/en

FINLAND

Theben OY

Liikkalankuja 6
00950 Helsinki
Phone +358 9 4242 7877
info@theben.fi
www.theben.fi

FRANCE

Theben S.A.R.L.

ZAC de la Madeleine
15 Rue de la Tuilerie
77500 Chelles
Phone +33 1 82770100
Fax +33 1 60200083
theben@theben.fr
www.theben.fr

GREAT BRITAIN

Timeguard Ltd

Victory Park, 400 Edgware Road
London NW2 6ND
Phone +44 208 4508944
Fax +44 208 4525143
csc@timeguard.com
www.timeguard.com

ITALY

Theben S.R.L.

Piazza Giorgio La Pira 4
20851 Lissone (MB)
Phone +39 039 9370 589
Fax +39 039 9370 608
info@theben.it
www.theben.it

NETHERLANDS

Theben Nederland

Laan van de Leeuw 34
7324 BD Apeldoorn
Phone +31 55 2020000
Fax +31 55 2020001
info@theben-nederland.nl
www.theben-nederland.nl

NORWAY

Theben AG NUF

Janaflaten 47
5179 Godvik
Phone +49 7474 692-0
rudolf.krischer@theben.de
sabine.fauler@theben.de
www.theben.no

SINGAPORE

Theben Asia Pte Ltd

25 International Business Park,
German Center #03-22/23
609916 Singapore
Phone +65 6560 3464-5
Fax +65 6560 5929
info@theben-asia.com
www.theben.asia

SWEDEN

Theben Electronics AB

Kanalvägen 16
19461 Upplands Väsby
Phone +46 10 450 7200
info@theben.se
www.theben.se

SWITZERLAND

Theben HTS AG

Im Langhag 7b
8307 Effretikon, SWITZERLAND
Phone +41 52 355 1700
Fax +41 52 355 1701
info@theben-hts.ch
www.theben-hts.ch

Smart home system

LUXORliving iON2.....	22
LUXORliving iON4.....	22
LUXORliving iON8.....	22
LUXORliving IP1.....	24
LUXORliving P640.....	24
LUXORliving set drives.....	25
LUXORliving set lighting.....	25
LUXORliving set drives lighting.....	25
LUXORliving set drives basic.....	25
LUXORliving S4.....	26
LUXORliving S8.....	26
LUXORliving S16.....	26
LUXORliving D2.....	28
LUXORliving D4.....	28
LUXORliving J4.....	29
LUXORliving J8.....	29
LUXORliving D1.....	30
LUXORliving J1.....	30
LUXORliving S1.....	30
LUXORliving H1.....	30
LUXORliving S1 RF.....	32
LUXORliving D1 RF.....	32
LUXORliving J1 RF.....	32
LUXORliving H1 RF.....	32
LUXORliving T4 RF.....	34
LUXORliving RF1.....	34
LUXORliving B6.....	36
LUXORliving T2.....	37
LUXORliving T4.....	37
LUXORliving T8.....	37
LUXORliving H6.....	38
LUXORliving H6 24V.....	39
LUXORliving R718.....	40
LUXORliving M140.....	41
LUXORliving M100.....	42
LUXORliving M130.....	42

KNX

iON 102 KNX.....	52
iON 104 KNX.....	52
iON 108 KNX.....	52
RMG 4 U KNX.....	54
RME 4 U KNX.....	54
RM 4 U KNX.....	54
RMG 4 I KNX.....	56
RME 4 I KNX.....	56
RM 4 I KNX.....	56
RM 8 I KNX.....	56
RM 4 H KNX.....	58
RM 8 H KNX.....	58
RMG 8 S KNX.....	60
RME 8 S KNX.....	60
RM 8 S KNX.....	60
RM 16 S KNX.....	60
RMG 8 T KNX.....	62
RME 8 T KNX.....	62
RM 8 T KNX.....	62
RM 16 T KNX.....	62
JMG 4 T KNX.....	64
JME 4 T KNX.....	64
JM 4 T KNX.....	64
JM 8 T KNX.....	64

JMG 4 T 24V KNX.....	66
JME 4 T 24V KNX.....	66
JM 4 T 24V KNX.....	66
JM 8 T 24V KNX.....	66
DMG 2 T KNX.....	68
DME 2 T KNX.....	68
DM 2 T KNX.....	68
DM 4 T KNX.....	68
DMB 1 T KNX.....	68
DM 4-2 T KNX.....	70
DM 8-2 T KNX.....	70
SMG 2 S KNX.....	72
SME 2 S KNX.....	72
DALI-Gateway KNX plus.....	74
DALI-Gateway S64 KNX.....	75
DALI-Gateway S128 KNX.....	75
Flush-mounted switching actuator.....	76
SU 1 KNX.....	76
Flush-mounted blind/switching actuator.....	76
JU 1 KNX.....	76
Flush-mounted dimming actuator.....	76
DU 1 KNX.....	76
Flush-mounted heating actuator.....	76
HU 1 KNX.....	76
SU 1 RF KNX.....	78
DU 1 RF KNX.....	78
JU 1 RF KNX.....	78
HU 1 RF KNX.....	78
TU 4 RF KNX.....	80
Media coupler TP-RF KNX.....	80
BMG 6 T KNX.....	82
BME 6 T KNX.....	82
BM 6 T KNX.....	82
BM 12 T KNX.....	82
TA 2 S KNX.....	84
TA 4 S KNX.....	84
TA 6 S KNX.....	84
TA 8 S KNX.....	84
thePrema P360 KNX UP WH.....	86
thePrema P360 KNX UP GR.....	86
thePrema S360 KNX UP WH.....	86
thePrema S360 KNX UP GR.....	86
thePrema P360 KNX AP Multi WH.....	88
Set basic KNX AP Multi WH.....	88
PlanoSpot 360 KNX DE WH.....	90
theRonda P360 KNX UP WH.....	92
theRonda S360 KNX AP WH.....	94
theRonda S360 KNX AP GR.....	94
theRonda S360 KNX FLAT DE WH.....	94
thePassa P360 KNX UP WH.....	96
PresenceLight 360B-KNX WH.....	98
PresenceLight 180B-KNX WH.....	100
theLuxa P300 KNX WH.....	102
theLuxa P300 KNX BK.....	102
IPsecure Interface KNX.....	104
IPsecure Router KNX.....	104
Interface USB KNX.....	105
Line coupler S KNX.....	105
PS 160 mA T KNX.....	106
PS 320 mA T KNX.....	106
PS 640 mA T KNX.....	106
KNX Set 1 FIX.....	107
KNX Set 2 FIX.....	107

KNX Set 3 MIX.....	107
KNX Set 4 KNX-RF.....	107
VARIA 826 S WH KNX.....	108
KNX-OT-Box S.....	109
RAMSES 718 P KNX.....	110
RAMSES 718 S KNX.....	111
MIX2 Base module.....	112
HMG 6 T KNX.....	112
MIX2 Extension module.....	112
HME 6 T KNX.....	112
FLIX1 module.....	112
HM 6 T KNX.....	112
FLIX2 module.....	112
HM 12 T KNX.....	112
HMT 6 S KNX.....	114
HMT 12 S KNX.....	114
CHEOPS control KNX.....	115
CHEOPS drive KNX.....	115
AMUN 716 S KNX.....	116
RAMSES 713 FC KNX.....	117
FCA 1 KNX.....	118
FCA 2 KNX.....	118
TR 648 top2 RC KNX.....	120
TR 648 top2 RC-DCF KNX.....	120
Wind, Rain, Brightness, Temperature122	122
Meteodata 140 S KNX.....	122
Wind, Brightness, Temperature.....	122
Meteodata 140 basic KNX.....	122
Wind, Rain, Brightness, Temperature, Time.....	122
Meteodata 140 S GPS KNX.....	122
Wind, Rain, Brightness, Temperature122	122
Meteodata 140 S 24V KNX.....	122
Wind, Rain, Brightness, Temperature, Time.....	122
Meteodata 140 S 24V GPS KNX.....	122
LUNA 134 KNX.....	124
LUNA 131 S KNX.....	126
LUNA 133 KNX.....	127
OSIRIA 220 AR KNX.....	128
OSIRIA 230 AR KNX.....	128
OSIRIA 230 SR KNX.....	128
OSIRIA 240 AR KNX.....	128
OSIRIA 240 SR KNX.....	128
OSIRIA 241 AR KNX.....	128
OSIRIA 241 BR KNX.....	128
OSIRIA 242 AR KNX.....	129
OSIRIA 242 SR KNX.....	129
OSIRIA 251 BQ KNX.....	129
OSIRIA 232 BQ KNX.....	129

Detectors/Sensors for indoor use

thePiccola P360-100 DE WH.....	136
theRonda S360-100 FLAT DE WH.....	138
theRonda S360-101 FLAT DE WH.....	138
theRonda S360-100 DE WH.....	140
theRonda S360-101 DE WH.....	140
theRonda S360-100 AP WH.....	142
theRonda S360-100 AP GR.....	142
theRonda S360-101 AP WH.....	142
theRonda S360-101 AP GR.....	142
theRonda S360-100 WH GST.....	144
theRonda S360-100 UP WH.....	146
theRonda S360-101 UP WH.....	146

theRonda S360 Slave UP WH.....	146
theRonda P360-100 M UP WH.....	148
theRonda P360-101 M UP WH.....	148
theRonda P360 Slave UP WH.....	148
theRonda P360-100 WH GST.....	150
thePassa P360-101 UP WH.....	152
thePassa P360 Slave UP WH.....	152
thePrema S360-101 E UP WH.....	154
thePrema S360-101 E UP GR.....	154
thePrema S360-100 E UP WH.....	154
thePrema S360-100 E UP GR.....	154
thePrema S360 Slave E UP WH.....	154
thePrema S360 Slave E UP GR.....	154
thePrema P360-101 E UP WH.....	156
thePrema P360-101 E UP GR.....	156
thePrema P360 Slave E UP WH.....	156
thePrema P360 Slave E UP GR.....	156
PresenceLight 180.....	158
theMura S180-100 UP WH.....	160
theMura S180-101 UP WH.....	160
theMura S180 Slave UP WH.....	160
theMura S180-100 2W UP WH.....	160
theMura S180-100 B UP.....	160
theMura S180-101 B UP.....	160
theMura S180 Slave B UP.....	160
theMura S180-100 2W B UP.....	160
thePrema S360 DALI UP WH.....	162
thePrema S360 DALI UP GR.....	162
thePassa P360-221 DALI UP WH.....	164
theRonda P360-330 DALI UP WH.....	166
theRonda P360-110 DALI UP WH.....	166
theRonda S360-110 DALI UP WH.....	166
theRonda P360 DALI-2 S UP WH.....	168
theRonda S360 DALI-2 S UP WH.....	168
thePassa P360 DALI-2 S UP WH.....	170
PlanoSpot 360 DALI-2 S DE WH.....	172
thePrema P360 KNX UP WH.....	174
thePrema P360 KNX UP GR.....	174
thePrema S360 KNX UP GR.....	174
thePrema P360 KNX AP Multi WH.....	176
Set basic KNX AP Multi WH.....	176
PlanoSpot 360 KNX DE WH.....	178
theRonda P360 KNX UP WH.....	180
theRonda S360 KNX AP WH.....	182
theRonda S360 KNX AP GR.....	182
theRonda S360 KNX FLAT DE WH.....	182
thePassa P360 KNX UP WH.....	184
PresenceLight 360B-KNX WH.....	186
PresenceLight 180B-KNX WH.....	188
thePiccola S360-100 DE WH.....	190
theMova S360-100 FLAT DE WH.....	192
theMova S360-101 FLAT DE WH.....	192
theMova S360-100 DE WH.....	194
theMova S360-101 DE WH.....	194
theMova S360-100 AP WH.....	196
theMova S360-100 AP GR.....	196
theMova S360-101 AP WH.....	196
theMova S360-101 AP GR.....	196
theMova S360-100 WH GST.....	198
theMova P360-100 UP WH.....	200
LUXA 103-100 DE WH.....	202
LUXA 103-101 DE WH.....	202
LUXA 103-100 AP WH.....	202

LUXA 103-101 AP WH	202
LUXA 103-100 C DE WH	204
LUXA 103-100 UA WH	206
theMura S180-100 UP WH	208
theMura S180-101 UP WH	208
theMura S180 Slave UP WH	208
theMura S180-100 2W UP WH	208
theMura S180-100 B UP	208
theMura S180-101 B UP	208
theMura S180 Slave B UP	208
theMura S180-100 2W B UP	208
LUXA 103-200 T	210

Outdoor motion detectors

theLuxa E180 WH	214
theLuxa E180 BK	214
theLuxa R180 WH	216
theLuxa R180 BK	216
theLuxa S150 WH	218
theLuxa S150 BK	218
theLuxa S180 WH	218
theLuxa S180 BK	218
theLuxa S360 WH	220
theLuxa S360 BK	220
theLuxa P220 WH	222
theLuxa P220 BK	222
theLuxa P300 WH	222
theLuxa P300 BK	222

LED spotlights

theLeda B20L WH	226
theLeda B20L BK	226
theLeda B30L WH	226
theLeda B30L BK	226
theLeda B50L WH	226
theLeda B50L BK	226
theLeda B100L WH	226
theLeda B100L BK	226
Light module theLeda B WH	226
Light module theLeda B BK	226
Motion module theLeda B WH	226
Motion module theLeda B BK	226
Motion module RC theLeda B WH	226
Motion module RC theLeda B WH	226
Remote control theLeda B	226
theLeda S10 WH	228
theLeda S10 BK	228
theLeda S10 W WH	228
theLeda S10 W BK	228
theLeda S20 WH	228
theLeda S20 BK	228
theLeda S20 W WH	228
theLeda S20 W BK	228
theLeda S10L WH	230
theLeda S10L BK	230
theLeda S20L WH	230
theLeda S20L BK	230
theLeda P12 WH	232
theLeda P12 AL	232
theLeda P24 WH	232
theLeda P24 AL	232
theLeda P12L WH	234
theLeda P12L AL	234

theLeda P24L WH	234
theLeda P24L AL	234
theLeda D S AL	236
theLeda D SU AL	236
theLeda D U AL	236
theLeda D UD AL	236
theLeda D SL AL	238
theLeda D SUL AL	238
theLeda D UL AL	238
theLeda D UDL AL	238
theLeda D B AL	240
theLeda D B plus AL	240
theLeda D B plus S AL	240
theLeda D BL AL	240
theLeda D BL plus AL	240

Digital time switches

TR 610 top3	244
TR 612 top3	244
TR 610 top2	244
TR 610 top2 G	244
TR 610 top2 24V	244
TR 612 top2	244
TR 612 top2 24V	244
TR 611 top3	246
TR 611 top2 24V	246
TR 611 top3 RC	246
TR 611 top2 RC 24V	246
TR 622 top3	246
TR 622 top2 24V	246
SELEKTA 170 top3	248
SELEKTA 174 top3	248
SELEKTA 170 top2 24V	248
SELEKTA 171 top3 RC	248
SELEKTA 171 top2 RC 24V	248
SELEKTA 172 top3	248
SELEKTA 172 top2 24V	248
SELEKTA 172 top3 RC	248
SELEKTA 175 top2	248
TR 641 top2	250
TR 641 top2 RC	250
TR 641 top2 RC 24V	250
TR 642 top2	250
TR 642 top2 RC	250
TR 642 top2 RC 24V	250
TR 644 top2	250
TR 644 top2 RC	250
EM 4 top2	252
TC 649 E	253
TR 608 top2 S	254
TR 609 top2 S	254
SELEKTA 175 top2	254
TR 635 top2	256
TR 636 top2	256
TR 030 top3 UP	258
SELEKTA 070 top3 UP	258
TR 684-1 top2	260
theben-eltimo 020 S	262
theben-eltimo 020 S DCF	262

Analogue time switches

SYN 160 a	266
SUL 180 a	266

MEM 190 a	266
SYN 151 h	268
SYN 161 d	268
SUL 181 d	268
SUL 191 w	268
SUL 188 g	270
SUL 188 hw	270
SYN 169 s	272
SUL 189 s	272
SUL 189 s 110V	272
SYN 269 h	274
SUL 289 h	274
SUL 289 g	274
TM 179 h	276
SUL 189 hw	276
SUL 285/2 T	278
theben-timer 26	279
theben-timer 26 IP 44	279
theben-timer 27	279
FRI 77 g	280
FRI 77 h-2	280
FRI 77 g-2	280

Staircase time switches

ELPA 1	284
ELPA 6	284
ELPA 6 plus	284
ELPA 3	284
ELPA 7	284
ELPA 8	286
ELPA 9	286
ELPA 041	288
ELPA 047	288

Dimmer

DIMAX 532 plus	292
DIMAX 534 plus	292
DIMAX 541 plus E	294
DIMAX 542 plus S	294
DIMAX 544 plus P	294

Twilight switches

LUNA 108 plus EL	298
LUNA 108 plus AL	298
LUNA 110 plus EL	298
LUNA 110 plus AL	298
LUNA 111 top3 AL	300
LUNA 111 top3 EL	300
LUNA 112 top3 AL	300
LUNA 112 top3 EL	300
LUNA 121 top3 RC AL	302
LUNA 121 top3 RC EL	302
LUNA 122 top3 RC AL	302
LUNA 122 top3 RC EL	302
LUNA 126 star E	304
LUNA 127 star S	304

Time relays/Hour counters

TM 345 M	308
TM 345 B	308
BZ 142-1	310
BZ 142-1 10V	310

BZ 142-1 230V	310
BZ 142-1 24V	310
BZ 142-3	310
BZ 142-3 10V	310
BZ 143-1	310
BZ 143-1 10V	310
BZ 143-1 24V	310
BZ 145	310
BZ 145 24V	310
BZ 146	312
BZ 147	312
BZ 148	312

Clock thermostats

RAMSES 812 BLE	316
RAMSES 814 BLE UP	317
RAMSES 816 BLE	318
RAMSES 816 BLE 2	318
RAMSES 816 BLE 3	318
RAMSES 811 top2	320
RAMSES 831 top2	320
RAMSES 812 top2	322
RAMSES 832 top2	322
RAMSES 366/1 top2	324
RAMSES 850 BLE OT	325
RAMSES 813 top2 HF Set A	326
RAMSES 813 top2 HF Set 1	326
RAMSES 833 top2 HF Set 1	328
RAMSES 833 top2 HF Set 2	328
RAMSES 816 top2 OT	330
RAMSES 856 top2 OT	332
RAMSES 784 S	334
RAMSES 722 S	334
RAMSES 784	336
RAMSES 722	336
RAMSES 782	336
RAMSES 721	336
RAMSES 725	336

Room thermostats

AMUN 716 CO2 Monitor	342
AMUN 716 SR	344
SOTHIS 715	345
RAMSES 701	346
RAMSES 702	346
RAMSES 703	346
RAMSES 704	346
RAMSES 705	346
RAMSES 706	346
RAMSES 707	346
RAMSES 708	346
RAMSES 709	346
RAMSES 741	348
RAMSES 746	348
RAMSES 748	348
RAMSES 741 RA	348
RAMSES 746 RA	348
RAMSES 748 RA	348
RAMSES 714	350
RAMSES 714 A	350
RAMSES 751 RA	350

Follow Theben on the Internet:



theben

Theben AG
Hohenbergstraße 32
72401 Haigerloch
Telefon +49 7474 692-0
Telefax +49 7474 692-150
info@theben.de
www.theben.de

Service Hotline
hotline@theben.de
+49 7474 692-369
KNX-Hotline: +49 7474 692-394
Monday to Thursday 7.00 am to 6.00 pm,
Friday 7.00 am to 4.00 pm