

LUTEC

CONNECTED BY LIGHTING



OUTDOOR LIGHTING

2020

European Warehouse Portfolio

LUTEC

ECW Portfolio

OUTDOOR LIGHTING 2020

LUTEC China Head Office
CN8, Far-East Industry Park,
Yuyao, Zhejiang, China
+86-574-62760832
info@lutec.net

LUTEC Europe Regional Office
Herentalsebaan 425
2160 Wommelgem, Belgium
+32 3 284 51 62
info@lutec-europe.com

**LUTEC in Germany
Austria - Switzerland**
ECO-LIGHT Leuchten GmbH
+49-228-9691090
sales@eco-light.biz

LUTEC in France
Prof & Wholesale channel
LUTEC France S.A.S
+33-04-75602598
commande@lutec-france.fr

DIY & Specialist channel
COREP SAS
+33-05-56 49 96 00
contact@corep.com

LUTEC in Iberia
Prof & Specialist channel Spain
Silumin S.L.
+34 93 892 40 51
silumin@silumin.es

Prof & Specialist channel Portugal
Duarte Neves LDA
+351 219 668 100
info@duarteneves.pt

DIY & Garden channel
Spain & Portugal
LUTEC Lighting Iberia S.L.
+34 93 500 12 21
administracion@luteciberia.com

**LUTEC in Hungary-Slovenia-Croatia
Czech-Slovakia**
LUTEC Lighting Kft
+36 30 897 8494
info@lutec.hu

LUTEC in Poland
DELIGHTING Polska
+48 61 4367 481
kontakt@delighting.pl

LUTEC in Belgium - The Netherlands
WEBRANDS Benelux
+32 3 369 26 16
info@webrands.eu

LUTEC in Italy
Lightec Srl.
+39 031 3551342
info@lightecsr.com

LUTEC in Greece - Cyprus
Samba - Eliezer
+30 2104820946
info@samba-eliezer.gr

LUTEC in United Kingdom - Ireland
LUTEC UK Ltd
+44 (0) 1992 760870
sales@lutecuk.com

LUTEC in Denmark
LUTEC Scandinavia A/S
+45 31 63 16 11
Sales@lutec-scandinavia.com

LUTEC in Ukraine
Eurotrade
+38 044 496 74 83
anton@eurotrade.net.ua

LUTEC in Russia
Oasis Light
+7 499 5501529
agata-v@rambler.ru

LUTEC in Middle East
StarsLine Lighting
+971 4 354 9550
info@starsline.net

LUTEC in United States - Canada
LUTEC USA LLC
+(704) 980 4135
shelley.greenberg@lutec.net

LUTEC in Australia - New Zealand
Evolt Pty Ltd
+61 2 9502 1161
sales@evolt.com.au

LUTEC in South Korea
Belko Co., Ltd
+82 2 465 0603
belko@belko.co.kr

LUTEC in Chile
Manufacturas Eléctricas ByP Ltda.
+56 228 769 400
online@byp.cl

China Central Warehouse in
Yuyao

European Central Warehouse
Bornem- Belgium

www.lutec.com

LUTECH

CONNECTED BY LIGHTING

20

OUTDOOR LIGHTING

Hello,
nice to meet you
we are

LUTECH

CONNECTED BY LIGHTING

one LUTECH, one **lighting** world

We think that outdoor lighting is one field with different needs and approaches. Our main challenge, using our experience, is to propose creative solutions to enlighten your outdoor living space.

As LUTECH, we have made this open choice to embrace this field of activity most completely.

Architectural, with wall and ceiling decorative lamps, specific light effects, functional with directional or recessed lights, the garden, the paths and terraces... Entering in the solar lighting is more than trendy, the solar energy being an active part of our future.

Begun recently, the activity related to safety and comfort has gained importance. New connected camera ranges are developed. The world of colour and programming to manage all your lights now enters our collections.

One world, different faces, different segments developed with the same concern of quality and efficiency.

discover what's new

make your outdoor life smarter

LUTEC introduces a range of Outdoor luminaires with the integrated TUYA connected light module. Combining high quality weatherproof aluminium fixtures with endless possibilities to control the powerful LED light.

Always connected

Thanks to the Bluetooth mesh technology, with sender-receiver module inside every lighting device, there will be no problems to reach all your connected luminaires. Also the ones in a more remote position.

Correlated Colour Temperature

The lighting module offers you a complete scale of CCT tuneable whites. In this way you can create a cosy warm white light or dynamic cold white light setting in your garden.

Convenient, Comfortable & Personal

Thanks to the "groups" function and "automation scenario's" function in the TUYA app, you can create & program the perfect outdoor atmosphere for every occasion.



FULL CONTROL

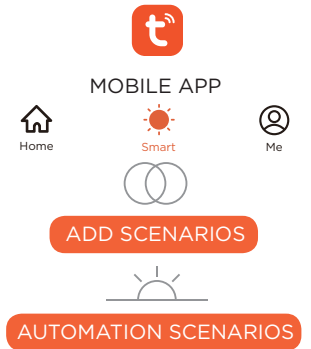

EASY CONNECTION



BLUETOOTH MESH TECHNOLOGY

DIMMING



TUNEABLE WHITES

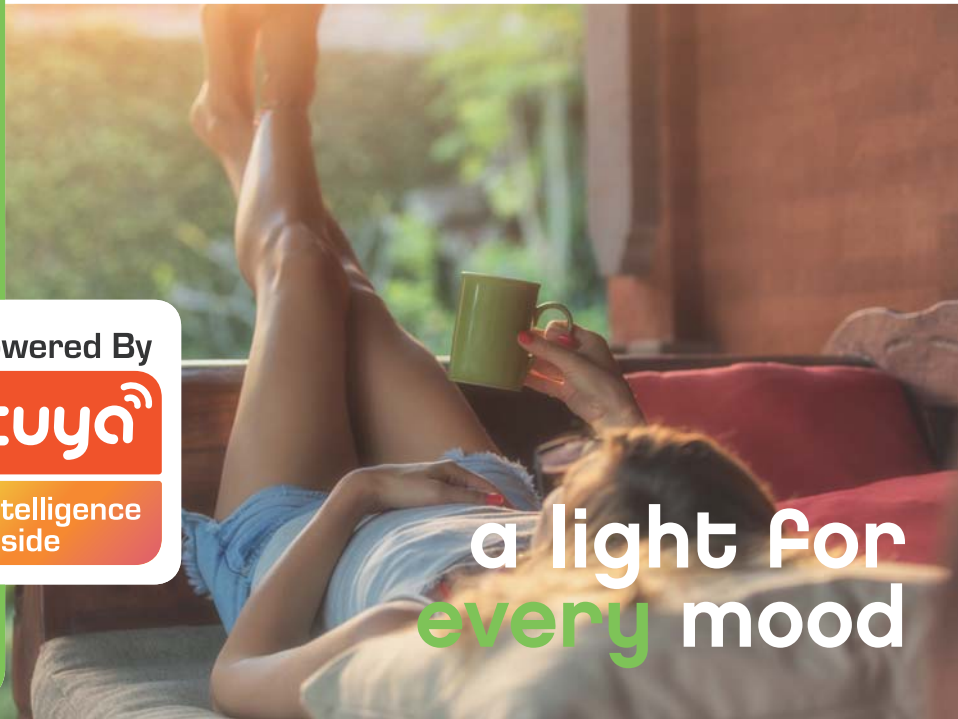
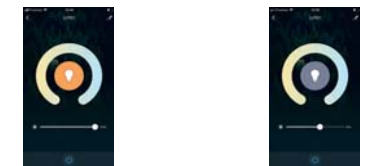

a light for every mood

Powered By



Intelligence Inside



Give it your own twist

LUTEC offers a number of new outdoor LED wall & bollard lights, for consumers, who want to create versatile light effects around their homes in a playful though convenient way.

Red Dot Award Winner 2019 Product Design

"Truly a great achievement and a testimony to the good design of the CUBA, tuneable up & down Outdoor LED light"

Create your own lighting designs

Next to the CYRA model in round shape with similar characteristics, LUTEC has extended this well appreciated range with a number of one head wall & bollard versions. Compact solutions, providing the same superb lighting effects and product flexibility.

"Total Eclipse of The Heart"

You can turn around the two half moon shape diffusers of the new ECLIPS model over an angle of 90 degrees. In this way creating a combination of an Up & Down light, a Wall Washer or a Frontal light effect.



reddot award 2019 winner



there's a new tradition

Next to the retrofit-series CATE & KELSEY, LUTEC introduces this year the new FLAIR tradition series.

Cottage flair around your house

The FLAIR lantern-family offers you a complete range Wall & Bollard lights for all your garden & terrace applications. A special double-head lantern and portable table lantern will give you plenty of choices to make your favourite ambience light settings.

Vintage flair LED filament bulbs

You can apply the newest decorative filament LED bulbs in the FLAIR models. These lamps are now available in all forms & shades. The connected & tuneable models will facilitate the full control of the lights at your personal desire. A warm amber glow turns your garden into a cosy & charming environment.



P 209



P 211



P 209



P 211



P 207



Always connected with your home

As market initiator LUTEC is proud to present the 2nd generation of the connected camera range.

Improved camera & connectivity

This brand new range has been developed based on learning and consumer insights over the last 3 years and by applying the gains and innovations of the fast evolving connected technology.

Keep an eye at your front door

This has resulted in a limited range of compact and very convenient camera lighting fixtures, ready to install or to make a swift replacement of your actual outdoor luminaires.

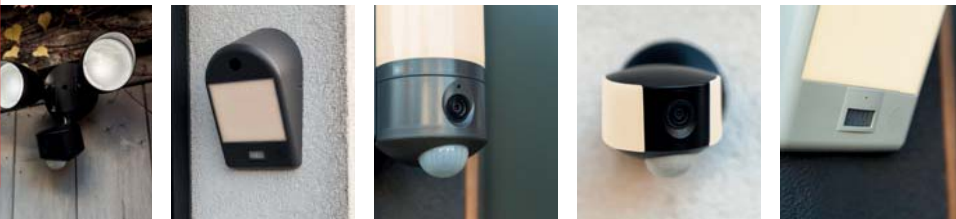
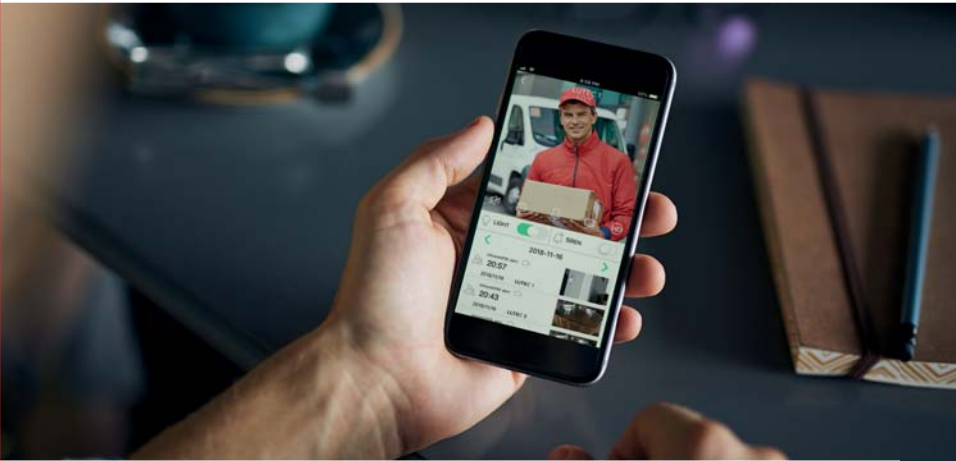

let the sun POPPY

LUTEC has a variety of different concepts covering the complete solar energy field.

A lighted flower

New in the portable offer is the POPPY Solar floor stand, the all in one lighting solution to enjoy your summer nights.

Party all night long

Designed for private gardens and for professional use on the terrace of your favourite restaurant or summer bar.



outdoor lighting



connected light



architectural



tradition

our 7 activity segments



security



solar



worklight



Functional

connected light

CONNECTED LIGHT is now already the future for all your lighting applications in the garden and around your home.

LUTEC offers two different solutions. A range of Outdoor luminaires with the integrated WiZ connected light module, operating on WiFi technology and featuring dimming, whites and colours. Allows you to take full control of your lights anytime and anywhere.

Adopting the Bluetooth mesh technology, the new TUYA connected ranges, are also suitable for distant installations in your garden. CCT control from Warm White to Cool White with a simple move on your smartphone. Convenient and creating the desired tuneable light.

make your
outdoor life
smarter

connected light

wall

tuya



NEW

KIRA

5288901118 / P21

tuya



NEW

DAKOTA

5288601118 / P23

wiz



QUBO

5193003118 / P25

wiz



SPICA

5271002118 / P27

wiz



FARELL

5194804001 / P31

wiz



GEMINI

5189111118 / P33

wiz



EXPLORER

6609204118 / P35

wall & ceiling

wiz



ORIGO

6335142118 / P29

spike

tuya



NEW

DAKOTA

7288602118 / P23

wiz



EXPLORER

6609205118 / P35

bollard

tuya



NEW

KIRA

7288901118 / P21

tuya



NEW

DAKOTA

7288601118 / P23

wiz



QUBO

7193002118 / P25

wiz



SPICA

7271004118 / P27



kira

wall & bollard

The KIRA outdoor LED wall & bollard light featuring a bended and frameless diffusor, distributes a homogenous & tuneable white light to illuminate walls, pathways and other open spaces around your home. The integrated TUYA Bluetooth connected module gives you all freedom to control your lights from the palm of your hand.



5288901118

CLASS I
IP54
LED 18W
1200 Lumen
Die Cast Aluminium

A+

2700K-6500K



7288901118

CLASS I
IP54
LED 18W
1200 Lumen
Die Cast Aluminium

A+

2700K-6500K





dakota

wall & bollard & spike

Robust LED outdoor wall & bollard light, its conical shape directing the tuneable white spotlight towards all the desired spots in your garden and around your home. The integrated TUYA Bluetooth connected module gives you all freedom to control your lights with the TUYA App on your smart devices. Comes also in a portable spike version with wire & plug.



5288601118

CLASS I
IP54
LED 12W
800 Lumen
Die Cast Aluminium



2700K-6500K

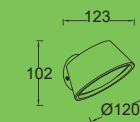

7288601118

CLASS I
IP54
LED 12W
800 Lumen
Die Cast Aluminium



2700K-6500K

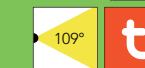

7288602118

CLASS I
IP54
LED 12W
800 Lumen
Die Cast Aluminium



2700K-6500K

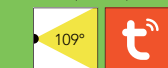
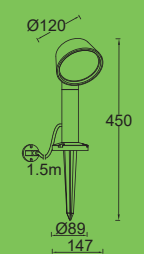



► Also available in non connected version



qubo

wall & bollard

Wall & bollard light creating a stunning atmosphere while making an architectural statement. Ideal for general lighting around your house, your garden or driveway. The integrated WiZ connected light module gives you full control anywhere and anytime.



5193003118

CLASS I
IP54
LED 16W
1000 Lumen
Die Cast Aluminium
A*

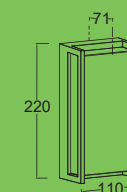

7193002118

CLASS I
IP54
LED 16W
1000 Lumen
Die Cast Aluminium
A*





spica

wall & bollard

Contemporary designed wall & bollard light with a distinctive shaped diffuser gives your garden an elegant look.

Comes with an integrated WIZ connected light module resulting in endless possibilities to control the powerful LED light.



5271002118

CLASS I
IP54
LED 16W
1000 Lumen
Die Cast Aluminium

A+

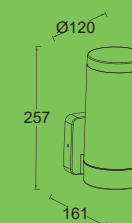

7271004118

CLASS I
IP65
LED 16W
1000 Lumen
Die Cast Aluminium

A+

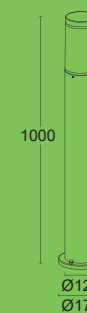



► Also available in non connected version



origo

wall & ceiling

The specific positioning of the opal polycarbonate diffuser creates a very nice circular glow on your external walls or ceilings. Now also available in LED integrated version, with an improved homogeneous light without any shadows. The integrated WiZ connected light module gives you full control anywhere and anytime.



6335142118

CLASS I
IP54
LED 16W
1000 Lumen
Die Cast Aluminium

A*

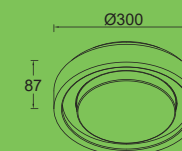



► Also available in **WIZ** connected version



Farell

wall

Robust yet elegant stainless steel wall light with integrated WIZ connected light module. The big diffusor surface features a homogeneous light in every desirable light color or intensity.



5194804001

CLASS II
IP44
LED 14W
900 Lumen
Stainless Steel

A+

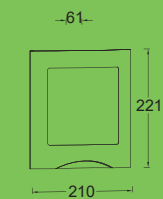



► Also available in non connected version



gemini

wall

This medium size version of the famous GEMINI range is very convenient for an installation on larger external walls or entrances. Thanks to the light output of 900 lumen the light beam will cover a big part of the surface in two directions. Comes with the integrated WIZ connected light module, which gives you full freedom & convenience to control your lights.



5189111118

CLASS I
IP54
LED 18W
900 Lumen
Die Cast Aluminium

A+

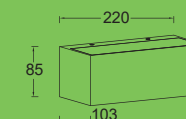

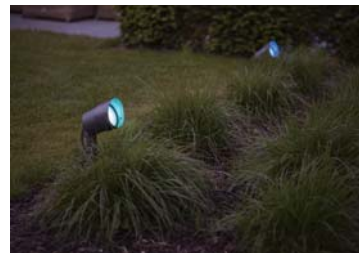

explorer

wall & spike

Elegant and compact spotlight on a spike, orientable horizontally and vertically, featuring a warm white LED light beam. The separate spot-cap can be used to direct the light beam to avoid any glare. Comes with WiZ connected light module.



6609204118

CLASS I
IP54
LED 7W
430 Lumen
Die Cast Aluminium
A+

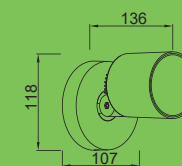

6609205118

CLASS I
IP54
LED 7W
430 Lumen
Die Cast Aluminium
A+

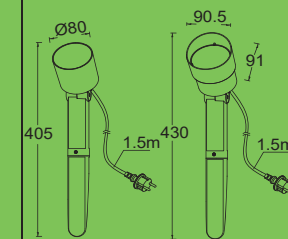

► Also available in non connected version

ARCHITECTURAL applies to all lighting installations for homes, terraces and gardens covering a contemporary and modern design.

LED's have drastically influenced the creation of new lighting products. Need for efficiency but also for harmonious integration when using one or several products : wall, bollards, ceiling and bulkhead designs. The offer is responding to architectural variety, location and living contexts. A good match can be found in between the luminaire and the architectural elements, in form, colour or material.

light up
your garden
in style

wall



CUBA
5193801118 / P43



NEW
CUBA
5193803118 / P45



NEW
EKLIPS
5199001118 / P47



CYRA
5198101118 / P49



CYRA
5198102118 / P49



NEW
CYRA
5198104118 / P51



MINI LEDSPOT
5614401118 / P53



MINI LEDSPOT
5614402118 / P53



MINI LEDSPOT
5614404118 / P53



TRUMPET
5626001118 / P57



TRUMPET
5626002118 / P57



TRUMPET
5626101125 / P57



EXPLORER
6609202118 / P59



NEW
PANO
5289001118 / P61



ANDA
5252101118 / P63



MERIDIAN
5616302118 / P65



MERIDIAN
5616304118 / P65



GHOST
5188003118 / P69



WHISPER
5198701001 / P71



ALICE
5194301118 / P73



ALICE
5194302118 / P73



APOLLO
5188801118 / P75



QUBO
5195401118 / P77



QUBO
5193001118 / P79



QUBO
5193002118 / P79



NEW
CRUZ
5199201118 / P81



TELIN
5197002125 / P83



FACE
5033001001 / P85



FACE
5033002001 / P85



SECO
5189901118 / P87



ADALYN
5193602118 / P89



TANGO
5192901118 / P91



BATI
5188601125 / P93



BATI
5188602125 / P93



FACCIA
5192801118 / P97



TONA
5189601118 / P99



TONA
5189602118 / P99



ZERTA
5189501118 / P101



BOX CUBE
5184601118 / P103



CITY
5183601118 / P105



NEW
URBAN
5196501118 / P107



LOTUS
5193201118 / P109



PILO
5186902118 / P111



NEW
HILL
5195801001 / P113



GEMINI
5189102118 / P115



GEMINI
5189102032 / P115



GEMINI
5189103118 / P115



GEMINI
5189113118 / P115



GEMINI
5189101118 / P117

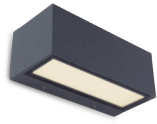

GEMINI
5189112118 / P117



GEMINI
5189114118 / P119



GEMINI
5189104118 / P119



MAYA
5198302001 / P121



MAYA
5198401001 / P121



CRYSTAL
5521201001 / P123



CRYSTAL
5521601001 / P123



LEO
5192701118 / P125



LEO
5192701335 / P125



PATH
5605701112 / P127



PATH
5605702112 / P127



FOCUS
5604011118 / P129



FOCUS
5604010118 / P129



FOCUS
5605013118 / P133



FOCUS
5605103118 / P133



NEW
BULLO
6383001118 / P135



NEW
BULLO
6383001445 / P135



HELENA
6402101118 / P147



HELENA
5191601118 / P147



HELENA
5191602118 / P147



BONN
6330401118 / P149



BONN
6330402001 / P149

wall
&
ceiling



FOCUS
6304201118 / P131



NEW
ROLA
6382201118 / P137



UBLO
6348102112 / P139



UBLO
6350102112 / P139

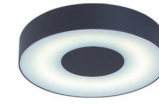

UBLO
6348101112 / P141



UBLO
6350101112 / P141



TITAN
6336201118 / P143



SEINE
6338201118 / P145

spike



EXPLORER
6609201118 / P59

bollard



CUBA
7193801118 / P43

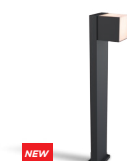

NEW
CUBA
7193802118 / P45



NEW
CYRA
7198101118 / P51



MINI LEDSPOT
7214603118 / P55



MINI LEDSPOT
7214604118 / P55



NEW
PANO
7289001118 / P61



ANDA
7225201118 / P63



MERIDIAN
7216412118 / P67



QUBO
7193001118 / P79



NEW
CRUZ
7199201118 / P81



BATI
7188601125 / P95



FOCUS
7204803118 / P131



NEW
MAINS
9702201012 / P151



NEW
MAINS
9702202012 / P151

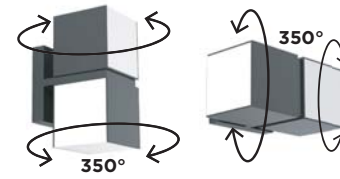

reddot design award
winner 2019



cuba

wall & bollard

Modern & versatile wall light suitable for vertical and horizontal mounting. The 2 light heads can be rotated over 350°, resulting in up - down or side light effects. Comes also in a 75cm bollard version.



5193801118

CLASS I
IP54
LED 23W
1000 Lumen
Die Cast Aluminium

A+

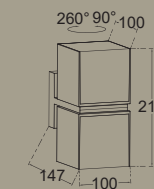
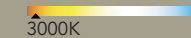

7193801118

CLASS I
IP54
LED 23W
1000 Lumen
Die Cast Aluminium

A+

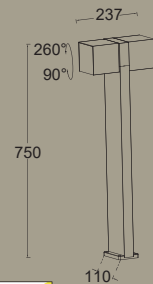

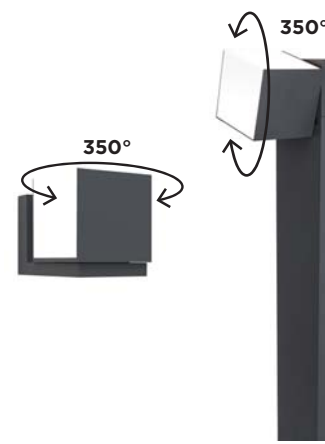
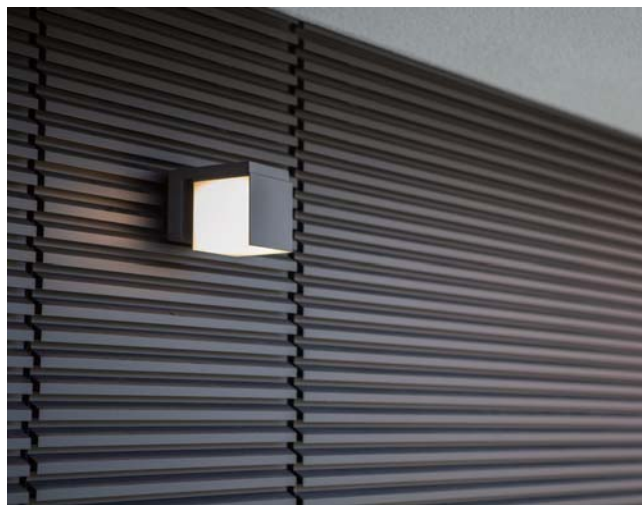

cuba

wall & bollard

CUBA, design award winning LED light, now available in a one head wall & bollard version. Resulting in a compact solution providing the same superb lighting effects and orientation flexibility.



5193803118

CLASS I
IP54
LED 12W
600 Lumen
Die Cast Aluminium

A+

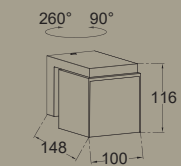

7193802118

CLASS I
IP54
LED 12W
600 Lumen
Die Cast Aluminium

A+

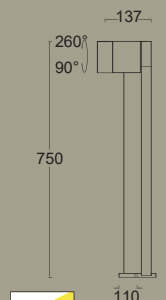



eklips

wall

Multi purpose LED Outdoor wall light with two half-moon shape diffusers. You can turn these two lightheads over an angle of 90°, creating a combination of an Up & Down light, a wall washer or a frontal light effect.

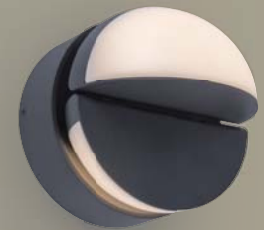

5199001118

CLASS I
IP54
LED 13W
1000 Lumen
Aluminium+Synthetics

A+

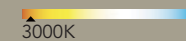

3000K





cyra

wall

Tubular wall light with a combination of anthracite grey aluminium body and opal white diffuser. The two moveable heads offer you a 350° rotation possibility resulting in a nice glow on your external wall or a frontal diffuse lightbeam. Comes also in a motion sensor version.



5198101118

CLASS I
IP54
LED 15W
1000 Lumen
Die Cast Aluminium

A+

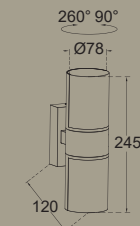

5198102118

CLASS I
IP54
LED 15W
1000 Lumen
Die Cast Aluminium

A+

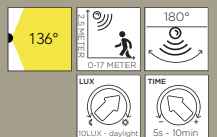
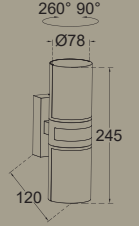



cyra

wall & bollard

Tubular outdoor LED light with a combination of anthracite grey aluminium body and opal white diffuser. The moveable heads offer you a 350° rotation possibility resulting in a nice glow on your external wall or frontal diffuse lightbeam. Now also available in a compact one head version as a wall or bollard light.



5198104118

CLASS I
IP54
LED 8W
500 Lumen
Die Cast Aluminium

A+

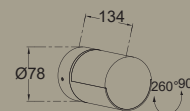
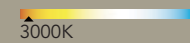

7198101118

CLASS I
IP54
LED 8W
500 Lumen
Die Cast Aluminium

A+

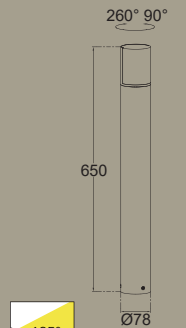



mini ledspot

wall

One or two light head versions. The light heads can rotate 320° and will give you a perfect solution as a spotlight or wall washer. It will create the desired ambiance. Adjustable PIR motion sensor with a 150° detection area.



5614401118

CLASS I
IP65
LED 9W
605 Lumen
Die Cast Aluminium

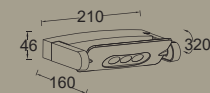

5614402118

CLASS I
IP65
LED 18W
1210 Lumen
Die Cast Aluminium

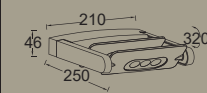

5614404118

CLASS I
IP54
LED 9W
605 Lumen
Die Cast Aluminium

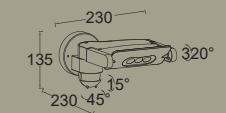

ADJUSTABLE	LUX 0-12 METER	TIME 10s - 8min



mini ledspot

bollard

This bollard is the perfect companion to light the pathways & terraces in your garden. The multidirectional heads will always direct the LED light to the desired spot.



7214603118

CLASS I
IP65
LED 9W
605 Lumen
Die Cast Aluminium

A+

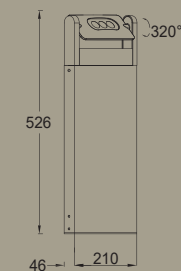
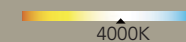

7214604118

CLASS I
IP65
LED 18W
1210 Lumen
Die Cast Aluminium

A+

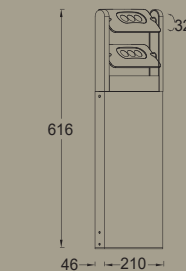
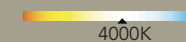



trumpet

wall

Accentuate your outdoor places with this powerful LED wall light with moveable spotlight. Large execution featuring a super powerful light beam of 1700 lumen. Now also available in small version with a light output of 600 lumen



5626001118

CLASS I
IP54
LED 11W
840 Lumen
Die Cast Aluminium

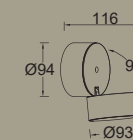
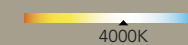

5626002118

CLASS I
IP54
LED 16W
1700 Lumen
Die Cast Aluminium

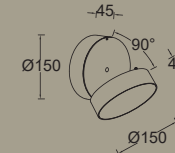
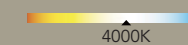

5626101125

CLASS I
IP54
LED 8W
600 Lumen
Die Cast Aluminium

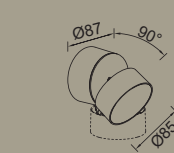



► Also available in [WIZ](#) connected version



explorer

wall & spike

Elegant and compact spotlight orientable horizontally and vertically, featuring a warm white LED light beam.

The separate spot-cap can be used to direct the light beam to avoid ant glare. Available in wall version and spike version with wire and plug.



6609202118

CLASS I
IP54
LED 5.3W
380 Lumen
Die Cast Aluminium

A+

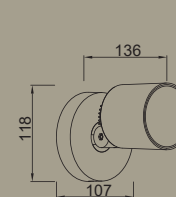
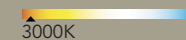

6609201118

CLASS I
IP54
LED 5.3W
380 Lumen
Die Cast Aluminium

A+

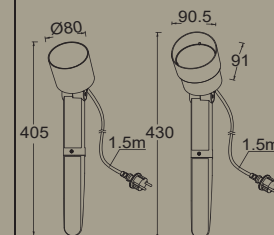
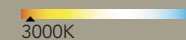

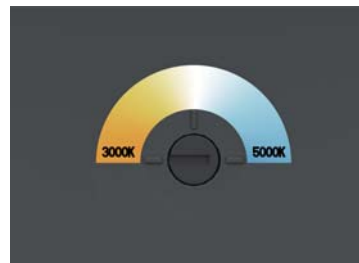

pano

wall & bollard

An elegant LED Outdoor wall & Bollard light with a ultra flat , frameless diffuser. Comes with an integrated adjustable colour switch. You can tune the light colour from warm white to cool white in a very convenient way.



5289001118

CLASS I
IP54
LED 16W
1200 Lumen
Die Cast Aluminium

A+

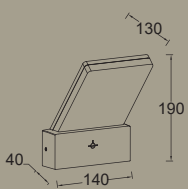

7289001118

CLASS I
IP54
LED 16W
1200 Lumen
Die Cast Aluminium

A+

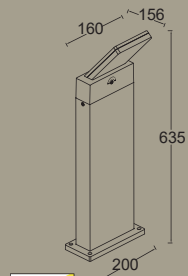



anda

wall & bollard

Wall light with a 1000 lumen light output, can be mounted at a certain height to illuminate a large area. The elegant but robust bollard will integrate well in your garden. The powerful light output will give a strong light but not dazzle people passing by.



525201118

CLASS I
IP54
LED 18W
1040 Lumen
Die Cast Aluminium

A+

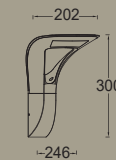

7225201118

CLASS I
IP65
LED 18W
1040 Lumen
Die Cast Aluminium

A+

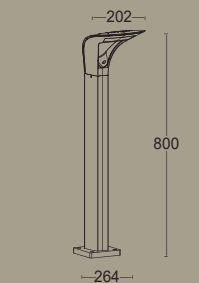



meridian

wall

Elegant combination of anthracite grey aluminium body and opal white polycarbonate diffuser. Small sized wall light gives a strong diffused light and a design statement in your garden. Now also available with an adjustable motion sensor, perfectly integrated in the luminaire base.



5616302118

CLASS I
IP54
LED 14W
800 Lumen
Die Cast Aluminium

A+

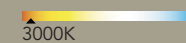

5616304118

CLASS I
IP54
LED 14W
800 Lumen
Die Cast Aluminium

A+

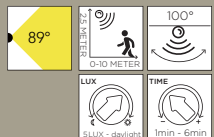
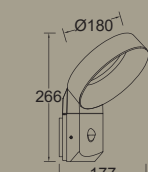



meridian

wall

Bollard at a perfect height which gives your pathway, terrace and garden the desired atmosphere at night without any glare.



7216412118

CLASS I
IP54
LED 14W
800 Lumen
Die Cast Aluminium

A+

3000K

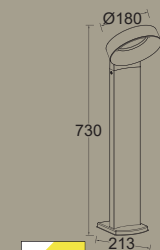



ghost

wall

Very sleek oval design which discretely gives an indirect light, resulting in a distinctive beam pattern.



5188003118

CLASS I
IP54
LED 7W
360 Lumen
Die Cast Aluminium

A*



4000K

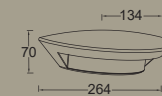

55°



suitable for smartbulb



whisper

wall

Modern round shaped wall light with retrofit solution. The synthetic housing makes it suitable for all types of smart connected bulbs working on different technologies : WiFi, Bluetooth, Ziggy.



5198701001

CLASS II
IP44
E27 Max.25W
Stainless Steel

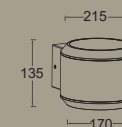



alice

wall

The square light-strip creates a fascinating almost fluid effect. The house number sticker set makes the package complete.



+ **1 · A**

5194301118

CLASS I
IP44
LED 13W
800 Lumen
Die Cast Aluminium

A+

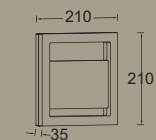
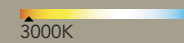

5194302118

CLASS I
IP44
LED 13W
800 Lumen
Die Cast Aluminium

A+

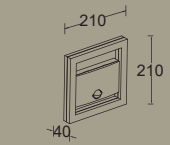



apollo

wall

Wall light with an optimal light combination. The narrow light beam shows a visually striking effect and the front diffuser radiates a homogeneous warm white LED light without any shadow. Ideal companion next to your front door.



5188801118

CLASS I
IP54
LED 14W
800 Lumen
Die Cast Aluminium

A+

3000K

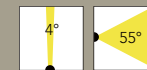
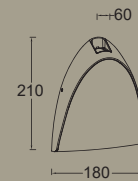



qubo

wall

Modern, small outdoor wall light new in our offer creating a stunning atmosphere while making an architectural statement. Ideal for general lighting in your garden or on your terrace.



5195401118

CLASS I
IP54
LED 8.5W
650 Lumen
Die Cast Aluminium

A+

3000K

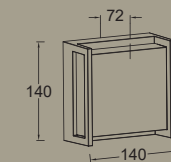



► Also available in **wiz** connected version



qubo

wall & bollard

Wall & bollard light creating a stunning atmosphere while making an architectural statement. Ideal for general lighting around your house, your garden or on your terrace. Also available with fully adjustable PIR motion sensor.



5193001118

CLASS I
IP54
LED 18W
1100 Lumen
Die Cast Aluminium

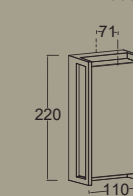

5193002118

CLASS I
IP54
LED 13W
800 Lumen
Die Cast Aluminium

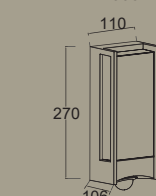
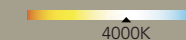

114° PIR 15m	180° PIR 15m
LUX 0-100 lux	TIME 10h - 8min
ADJUSTABLE	

7193001118

CLASS I
IP54
LED 18W
1100 Lumen
Die Cast Aluminium

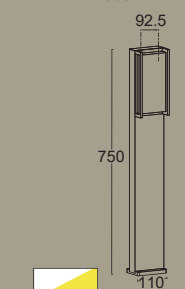



CRUZ

wall & bollard

This dark grey cube-shaped exterior light with integrated LED is a real eye-catcher due to its modern design. The warm white light shines in all directions which give your outdoor environment a particularly beautiful appearance. Available as wall lamp and bollard.

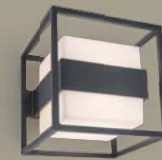

5199201118

CLASS I
IP54
LED 13W
1000 Lumen
Die Cast Aluminium

A+

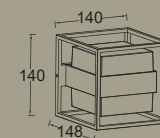
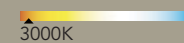

7199201118

CLASS I
IP54
LED 13W
1000 Lumen
Die Cast Aluminium

A+

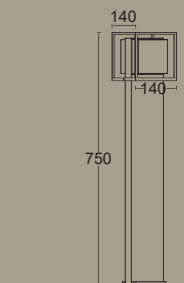



telin

wall

This LED wall light in anthracite grey sits in a cubic holder made of durable die cast aluminium. The elegant design catches the eye and radiates powerful rays of warm white light that illuminate the wall.



5197002125

CLASS I
IP54
LED 15W
800 Lumen
Die Cast Aluminium

A+

3000K

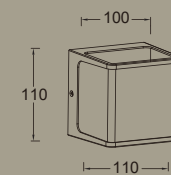



Face

wall

Robust yet elegant stainless steel wall light, big surface diffuses warm white light radiation. Discrete position of the adjustable PIR motion sensor.



5033001001

CLASS II
IP44
LED 13W
800 Lumen
Stainless Steel

A+

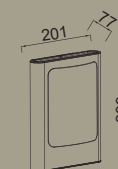

5033002001

CLASS II
IP44
LED 13W
800 Lumen
Stainless Steel

A+

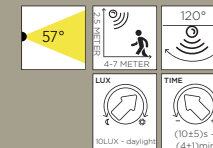
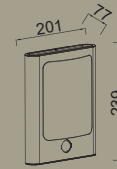
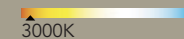



seco

wall

The clever designed aluminum backside of this fixture, offers an easy installation. The diffuser will give a floating effect on your walls.



5189901118

CLASS I
IP54
LED 13W
770 Lumen
Die Cast Aluminium

A+

3000K





adalyn

wall

This compact wall light will turn your garden into an intimate place and welcomes you at home. Smooth radiation of warm white LED light.



5193602118

CLASS I
IP44
LED 10W
600 Lumen
Die Cast Aluminium

A+

3000K

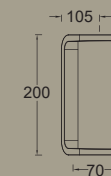



tango

wall

Featuring a double glass design, this Up & Down wall light creates a magical effect on your external walls or near your entry door.



5192901118

CLASS I
IP54
LED 17W
800 Lumen
Die Cast Aluminium

A+

3000K

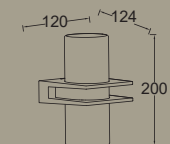



bati

wall

Modern & stylish wall light with integrated LED light and optional PIR sensor. Ideal for your front door or garden walls.



5188601125

CLASS I
IP44
LED 14W
1100 Lumen
Die Cast Aluminium

A+



5188602125

CLASS I
IP44
LED 14W
1100 Lumen
Die Cast Aluminium

A+





bati

bollard

Modern and stylish bollard with integrated LED light source. Ideal for your driveway or garden path in a multiple installation .



7188601125

CLASS I
IP44
LED 14W
1100 Lumen
Die Cast Aluminium

A+





Faccia

wall

Powerful & warm white light right to the area where it's needed. Subtle light beam at the back gives a nice glow on your external wall.



5192801118

CLASS I
IP54
LED 20W
1000 Lumen
Die Cast Aluminium

A+

3000K

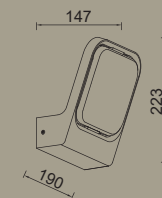



tona

wall

Thanks to the die-cast aluminum frame in one single piece, the smooth and gracious line is accentuated. The white opal diffuser with concentric circles is giving the right direction to the light and showing a subtle decorative detail during the day. Comes also with a build-in & adjustable motion sensor.



5189601118

CLASS I
IP44
LED 9W
600 Lumen
Die Cast Aluminium

A+

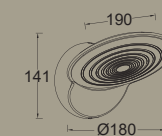

5189602118

CLASS I
IP44
LED 9W
600 Lumen
Die Cast Aluminium

A+

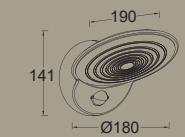



zerta

wall

The almost invisible "Stealth" form of this amazing wall light, houses a super powerful LED light-engine radiating a diffuse light. Best used at a certain height to light larger surfaces.

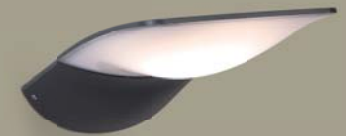

5189501118

CLASS I
IP44
LED 30W
2090 Lumen
Die Cast Aluminium

A+

3000K

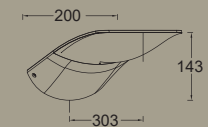



suitable for smartbulb



box cube

wall

Striking form fits in all your contemporary garden spaces. The opal impact proof diffuser offers the perfect homogeneous light without any shadows. Elegant construction with no screws on the surface. The E27 Edison fitting is suitable for all kind of retrofit bulbs.



5184601118

CLASS I
IP44
E27 Max.60W
Die Cast Aluminium

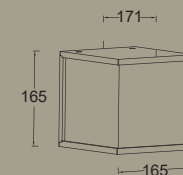



suitable for smartbulb



city

wall

Large size and robust wall light, fit to lighten large areas both in public or private places. The impact proof polycarbonate diffuser in combination with the sturdy die cast aluminum frame will make this fixture destruction proof.



5183601118

CLASS I
IP44
E27 Max.60W
Die Cast Aluminium

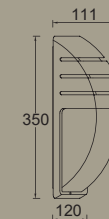



suitable for smartbulb



urban

wall

GU10 retrofit LED Outdoor wall light, suitable for the newest smart bulbs. The invisible lightbulb, creates a subtle light effect by the reflexion on the ribbed aluminium reflector.



5196501118

CLASS II
IP54
GU10 LED Max.7W
Die Cast Aluminium

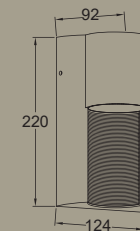



lotus

wall

Captivating design with a beautiful up & down light effect. This elegant wall light is the perfect addition to your entry door.



5193201118

CLASS I
IP54
LED 11W
500 Lumen
Die Cast Aluminium

A+

3000K

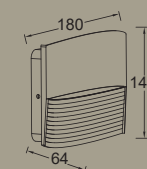



pilo

wall

Unique design radiating a glow in 4 directions, giving a distinctive light effect on your outdoor walls.

Ingenious construction without any screws: the frontal aluminum cover is fixed in the right position thanks to a magnet.



5186902118

CLASS I
IP54
LED 11W
760 Lumen
Die Cast Aluminium

A+

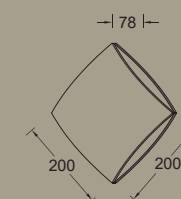



hill

wall

Modern Up & Down aluminium wall light with stainless steel decorative strip. It will enhance your outdoor places with a beautiful light effect.



5195801001

CLASS II
IP54
LED 8.5W
650 Lumen
Die Cast Aluminium

A+

3000K

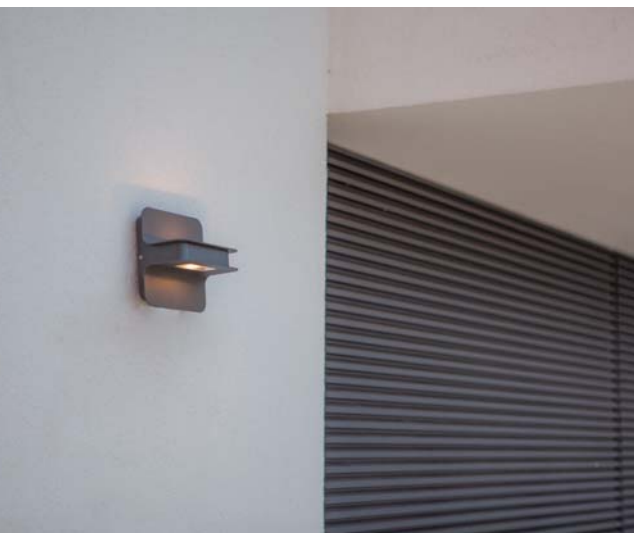
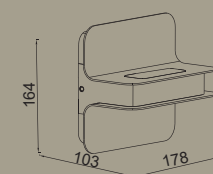



gemini

wall

Minimalistic design but great light output. This elegant "brick" light in die-cast aluminum radiates a perfect bi-directional beam. Comes in anthracite grey, white and stainless steel version.



5189102118
5189102032
5189103118

5189113118

CLASS I
 IP54
 LED 10.5W
 500 Lumen
 Die Cast Aluminium

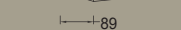
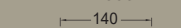

CLASS I
 IP54
 LED 10.5W
 500 Lumen
 Die Cast Aluminium

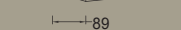
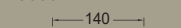



► Also available in **WIZ** connected version



gemini

wall

The medium version is very convenient for an installation on larger external wall or entrances. Thanks to the light output of 1200 lumen the light beam will cover the full surface in two directions. Available in warm white (3000K) and in daylight (4000K) execution

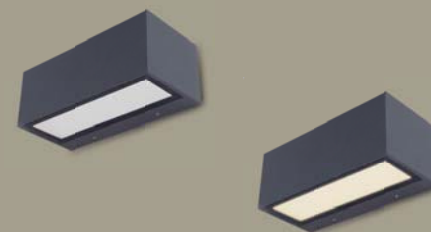

5189101118

CLASS I
IP54
LED 20W
1230 Lumen
Die Cast Aluminium

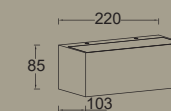

5189112118

CLASS I
IP54
LED 20W
1230 Lumen
Die Cast Aluminium

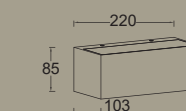



gemini

wall

The large version in this family is very convenient for an installation at a certain height for larger external walls or entrances. Thanks to a light output of more than 3000 lumen, the light beam will cover the full surface in two directions. A small square version is new in our offer.

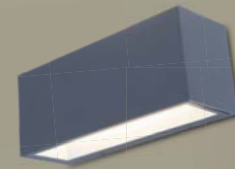

5189104118

CLASS I
IP54
LED 42W
3300 Lumen
Die Cast Aluminium

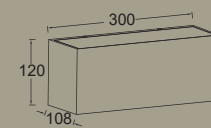

5189114118

CLASS I
IP54
LED 9W
850 Lumen
Die Cast Aluminium

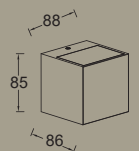



maya

wall

This small Up & Down wall light in Aluminium with stainless steel cover has a timeless design and is slim and efficient. Rectangular version comes with motion sensor.



5198302001

CLASS I
IP44
LED 15W
1000 Lumen
Stainless Steel

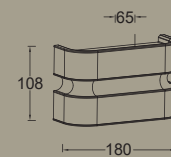

5198401001

CLASS I
IP44
LED 15W
1000 Lumen
Stainless Steel

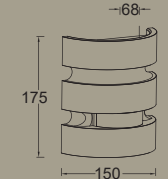



crystal

wall

Combination of brushed stainless steel housing and an optical lens, resulting in a magical and perfect aligned up & down beam pattern on your wall.



5521201001

CLASS I
IP44
LED 10W
660 Lumen
Stainless Steel

A+

3000K

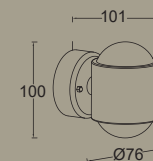

5521601001

CLASS I
IP44
LED 10W
660 Lumen
Stainless Steel

A+

3000K

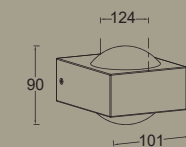



leo

wall

Magical wall light. The shiny silver coating makes it look like an invisible piece of lighting. Features a strong light beam up & down and a vertical light-strip in the front. The effect will be amplified in a multiple arrangement.



5192701118

CLASS I
IP54
LED 14W
870 Lumen
Die cast Aluminium
Chrome coating

A+



5192701335

CLASS I
IP54
LED 14W
870 Lumen
Die Cast Aluminium

A+

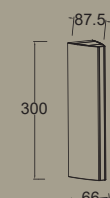



path

wall

Stainless steel Up & Down light with a discrete glowing part on both sides. Comes also in PIR motion-sensor version, very elegant incorporated and with a large detection reach.



5605701112

CLASS I
IP54
LED 15W
800 Lumen
Stainless Steel

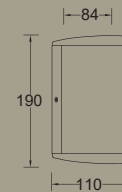

5605702112

CLASS I
IP54
LED 16W
800 Lumen
Stainless Steel

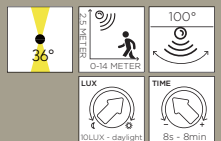
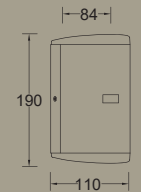



suitable for smartbulb



Focus

wall

Heavy duty die-cast aluminum versions available in anthracite color in combination with clear glass diffusors, giving a robust construction and a perfect light radiation both functional as decorative.



560401118

CLASS I
IP44
GU10 Max.2*35W
Die Cast Aluminium

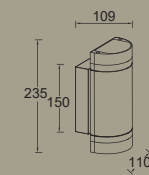

560410118

CLASS I
IP44
GU10 Max.35W
Die Cast Aluminium

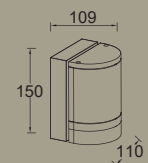



suitable for smartbulb



Focus

wall

Cylindrical versions with the very typical single or double horizontal light glow. This range is equipped with a traditional GU10 fitting and are suitable for halogen bulbs as for retrofit LED bulbs.



6304201118

CLASS I
IP44
GU10 Max.35W
Die Cast Aluminium

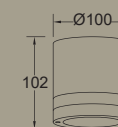

7204803118

CLASS I
IP44
GU10 Max.35W
Die Cast Aluminium





Focus

wall

Square execution in die-cast aluminum, with an integrated LED engine comes in a downlight version and in an up & down light version.



5605013118

CLASS I
IP44
LED 7.6W
300 Lumen
Die Cast Aluminium

A+

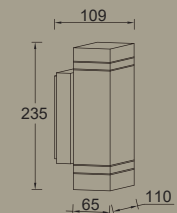
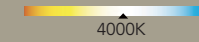

5605103118

CLASS I
IP44
LED 3.8W
150 Lumen
Die Cast Aluminium

A+

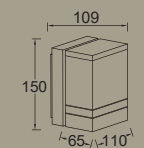
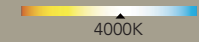



bullo

wall

LED Outdoor aluminium wall & ceiling light, in a modern interpretation of the classic bullseye design. Radiates a homogenous and strong warm white light. Available in dark grey and rust brown colour.



6383001118
6383001445

CLASS I
IP54
LED 15W
700 Lumen
Die Cast Aluminium

A+

3000K

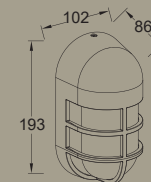



rola

wall

The round Rola outdoor wall lamp in dark grey colour with integrated LED and warm white light has a decorative frame in aluminum. An elegant wall & ceiling decoration that illuminates your outdoor spaces



6382201118

CLASS I
IP54
LED 13W
800 Lumen
Die Cast Aluminium

A+

3000K

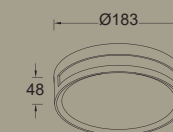



ublo

wall

Compact & elegant fixture producing a perfect uniform and homogenous warm white LED light without any shadow. Easy access to the connection part by removing click-on front plate.



6348102112

CLASS I
IP54
LED 8W
420 Lumen
Die Cast Aluminium

A+

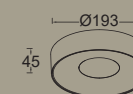
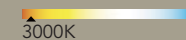

6350102112

CLASS I
IP54
LED 8W
420 Lumen
Die Cast Aluminium

A+

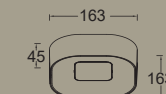
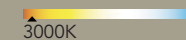



ublo

wall

Large size with same design & functionalities.
Double lumen output makes it very suitable for
illuminating a large space.



6348101112

CLASS I
IP54
LED 16.5W
950 Lumen
Die Cast Aluminium

A+

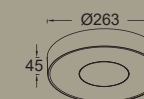
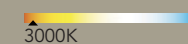

6350101112

CLASS I
IP54
LED 16.5W
950 Lumen
Die Cast Aluminium

A+

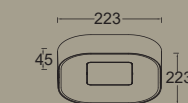
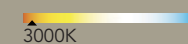



titan

wall & ceiling

Medium sized wall & ceiling light with a decorative aluminium cover creating the desired effect for the location. With traditional Edison fitting, it is suitable for energy saving bulbs, up to 60W. Easy installation with a standard loop in loop out wiring option.



suitable for smartbulb



6336201118

CLASS I
IP54
E27 Max.60W
Die Cast Aluminium

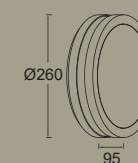



suitable for smartbulb



seine

wall & ceiling

Robust heavy duty die-cast aluminium fixture. This large model with two traditional E27 fittings, is suitable for different kind of retrofit bulbs offering a very powerful light output. The soft glowing light effect to the back creates a "floating" impression. Ideal for creating a safe atmosphere around your home at night.



6338201118

CLASS I
IP54
E27 2*20W CFL
Die Cast Aluminium

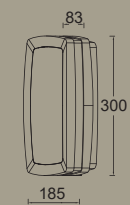



helena

wall

Orientation wall light with opal diffuser or directed down light. Very convenient built-on installation. Thickness of the luminaire is not more than 30mm. No more hassle to make a hole in your garden walls.



640210118

CLASS I
IP54
LED 4W
200 Lumen
Die Cast Aluminium

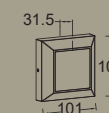
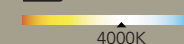

519160118

CLASS I
IP54
LED 10.5W
400 Lumen
Die Cast Aluminium

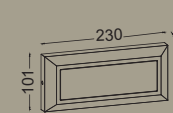
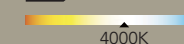

519160218

CLASS I
IP54
LED 10.5W
400 Lumen
Die Cast Aluminium

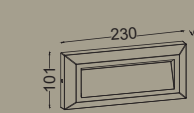
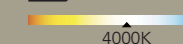



bonn

wall

This elegant anthracite or stainless steel wall light fits in perfectly with your contemporary outdoor surrounding. It creates a perfect bi-directional light effect on your walls. The small vertical window in the front adds to the character.

The traditional E27 fitting is suitable for energy saving bulbs but also for the latest LED retro-fit bulbs.

suitable for smartbulb



6330401118

CLASS I
IP54
E27 Max.60W
Die Cast Aluminium

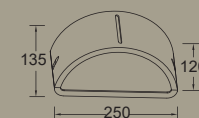

6330402001

CLASS II
IP44
E27 Max.40W
Stainless Steel





mains

These dark grey outdoor power supply sockets in die cast aluminium are very easy to install and provide your entire garden with energy, so you can enjoy your outdoor space. Comes with side earth or pin earth version. Total power supply up to 3500W.

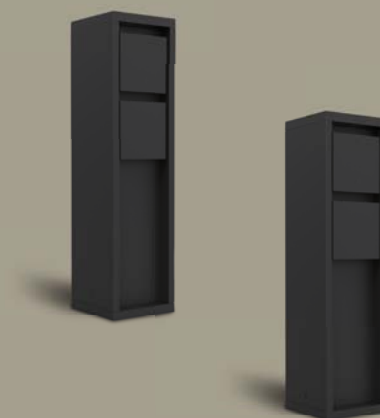

9702201012

CLASS I
IP54
Max.3500W
Die Cast Aluminium



9702202012

CLASS I
IP54
Max.3500W
Die Cast Aluminium



tradition

TRADITION applies to all lighting installations for homes, terraces and gardens, covering a more classical design. Revisiting the traditional lantern theme with LED integrated versions. The Edison-fitting versions are suitable for the newest vintage filament LED bulbs, resulting in a perfect combination between new technology and authentic style. Matching with all kind of traditional homes : Classic, Vintage, Cottage. Resulting in a harmonious integration when using one or several products of the same family: wall lantern, pedestal, small and big lantern posts.

there's a new
tradition

wall



ZOE
5240101012 / P157



UNITE
5260101012 / P159



UNITE
5260101030 / P159



UNITE
5260103012 / P159



UNITE
5260103030 / P159



UNITE
5260201012 / P159



UNITE
5260201030 / P159



AQUARIUS
5185901012 / P163



STARRY
5185701012 / P165



NEW FLAIR
5288801012 / P167



NEW FLAIR
5288802012 / P167



NEW FLAIR
5288803012 / P169



NEW FLAIR
5288804012 / P169



KELSEY
5273701012 / P173



KELSEY
5273601012 / P173



CATE
5264201213 / P177



DARLI
5274601412 / P179

portable



NEW FLAIR
6588801012 / P171

bollard



UNITE
7260401012 / P161



UNITE
7260401030 / P161



UNITE
7260311012 / P161



UNITE
7260311030 / P161



NEW FLAIR
7288801012 / P171



KELSEY
7273602012 / P175



KELSEY
7273601012 / P175



CATE
7264210213 / P177



CATE
7264230213 / P177



zoe

wall

Compact, vintage look lantern. Fits in all traditional surroundings. Incorporated LED tile radiates a gentle & warm light.



5240101012

CLASS I
IP54
LED 9W
330 Lumen
Die Cast Aluminum

A+

3000K

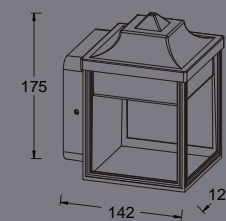



unite

wall

Complete collection, up & down lantern, pedestal and small post all in heavy duty die-cast aluminum and a transparent impact proof polycarbonate diffuser. The warm white light gives a cozy and traditional aspect. Now also available in white powder coating.



5260101012
5260101030

CLASS I
IP44
LED 9W
330 Lumen
Die Cast Aluminium



3000K



5260103012
5260103030

CLASS I
IP44
LED 9W
330 Lumen
Die Cast Aluminium



3000K

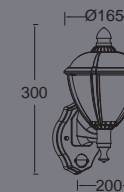

--	--	--

5260201012
5260201030

CLASS I
IP44
LED 9W
330 Lumen
Die Cast Aluminium



3000K

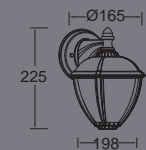



unite

bollard

Complete collection, up & down lantern, pedestal and small post all in heavy duty die-cast aluminum and a transparent impact proof polycarbonate diffusor. The warm white light gives a cozy and traditional aspect. Now also available in white powder coating



7260401012
7260401030

CLASS I
IP44
LED 9W
330 Lumen
Die Cast Aluminium
A+ 
3000K



7260311012
7260311030

CLASS I
IP44
LED 9W
330 Lumen
Die Cast Aluminium
A+ 
3000K





aquarius

wall

The authentic feel of this wall lantern fits perfectly to the country house style. The LED light source is perfectly integrated and gives a charming warm white light in combination with the transparent bubble glass diffuser.



5185901012

CLASS |
IP44
LED 17W
700 Lumen
Die Cast Aluminium

A+

3000K





starry

wall

Cottage style rectangular wall light. With water glass. The invisible LED light source is perfectly placed to create a very charming warm white light in combination with the water drop glass.



5185701012

CLASS I
IP54
LED 16W
600 Lumen
Die Cast Aluminium

A+

3000K

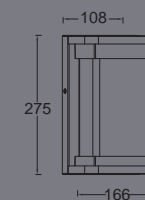



suitable for smartbulb



Flair

wall

The FLAIR lantern family in cottage style gives you the possibility to create a diverse lighting design in your garden & around your house in the same style. In combination with LED filament retrofit bulbs you will create a perfect cosy & safe atmosphere.



5288801012

CLASS I
IP44
E27 Max.40W
Die Cast Aluminium

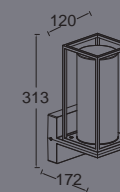

5288802012

CLASS I
IP44
E27 Max.40W
Die Cast Aluminium

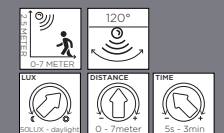
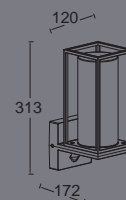



Flair

small wall & double wall

These two wall lanterns will create extra possibilities to work out the desired luminaires design around your home and beside your entry doors. Comes also with E27 fitting suitable for the newest filament LED bulbs.



5288803012

CLASS I
IP44
E27 Max.40W
Die Cast Aluminium

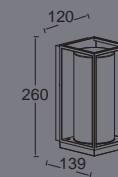

5288804012

CLASS I
IP44
2*E27 Max.40W
Die Cast Aluminium

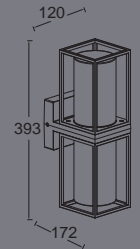

suitable for smartbulb





suitable for smartbulb



Flair

portable & bollard

The portable version, with an 1.5 meter outdoor wire and plug, will create a cosy atmosphere on your garden tables & terraces. The bollard makes the Flair family complete. Also these two executions are suitable for E27 filament LED retrofit bulbs.



6588801012

CLASS I
IP44
E27 Max.40W
Die Cast Aluminium

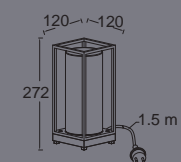

7288801012

CLASS I
IP44
E27 Max.40W
Die Cast Aluminium

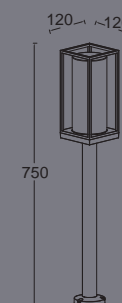



kelsey

wall

Give your outdoor spaces an intimate look and feel with this complete outdoor light family. While using the newest "filament" retrofit LED bulbs behind the water glass diffuser, you will create a charming atmosphere.



suitable for smartbulb



5273701012

CLASS I
IP44
E27 Max.40W
Die Cast Aluminium

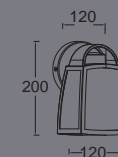

5273601012

CLASS I
IP44
E27 Max.40W
Die Cast Aluminium

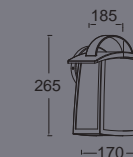



suitable for smartbulb



kelsey

bollard

Give your outdoor spaces an intimate look and feel with this complete outdoor light family. While using the newest "filament" retrofit LED bulbs behind the water glass diffuser, you will create a charming atmosphere.



7273602012

CLASS I
IP44
E27 Max.40W
Die Cast Aluminium



7273601012

CLASS I
IP44
E27 Max.40W
Die Cast Aluminium





cate

wall & bollard

This complete family with an authentic feel will turn your garden into a cozy & warm atmosphere, while using the newest "filament" LED bulbs.

suitable for smartbulb



5264201213

CLASS I
IP44
E27 Max.60W
Die Cast Aluminium

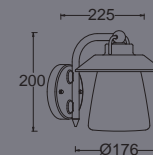

7264210213

CLASS I
IP44
E27 Max.60W
Die Cast Aluminium

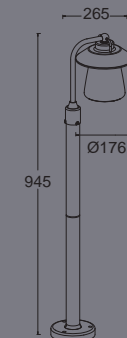

7264230213

CLASS I
IP44
3*E27 Max.60W
Die Cast Aluminium

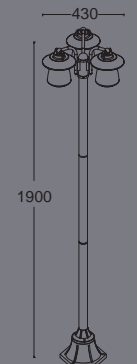



darli

wall down

Coach lantern with traditional finish and powerful warm white LED light.

Thanks to the built-in bluetooth speaker you can enjoy your favourite music outside your house all day & night.



5274601412

CLASS I
IP44
LED 24W
1500 Lumen
Die Cast Aluminium

A+

3000K

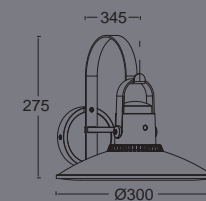

solar

solar?
yes, please!

SOLAR covers a variety of different concepts in the field of renewable energy lighting solutions. The portable range illustrates light mobility, pleasant and ubiquitous to use. The wall lights and bollards are built following two principles, using an integrated or independent solar panel, quick and easy to install. Today the highly efficient solar panel in combination with powerful LED modules are giving a really satisfactory light level. Making the most out of the available solar energy is cleverly realised by intelligent user interfaces such as 3-step dimmers, timers and PIR-sensors.

portable



NEW
POPPY
6910802335 / P187



TABLE CUBE
6908003331 / P189



TABLE CUBE
6908001337 / P189



TABLE CUBE
6908001331 / P189



TABLE CUBE
6908001339 / P189

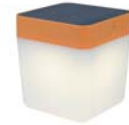

TABLE CUBE
6908001340 / P189



TABLE CUBE
6908002337 / P191



PADLIGHT
6907701331 / P193



PADLIGHT
6907701339 / P193



PADLIGHT
6907701340 / P193



DRAGONFLY
6904101337 / P195



DRAGONFLY
6904101331 / P195



DRAGONFLY
6904101339 / P195

wall
integrated
panel



MINI LEDSPOT
6914401000 / P197



ARROW
6910601335 / P199



BRICK
6908501308 / P201



BREAD
6901501000 / P203



BUBBLE
6908701001 / P205

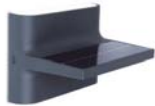

TWILL
6908901335 / P207



DISO
6906702335 / P209



NEW
CURTIS
6934601118 / P211



SOLSTEL
6907901000 / P213



GHOST SOLAR
6901401337 / P215



ZETA
6901101000 / P217



POLE
9700308112 / P219



TILLY
6901201000 / P221

bollard
integrated
panel



DISO
6906703335 / P209



SOLSTEL
6907903001 / P213



LONDON
6951301189 / P223

flood
independent
panel











SUNSHINE
6925601345 / P225



SUNSHINE
6901601000 / P227

complete lighting solution: green & convenient

-  **Solar Energy, no electricity consumption**
-  **Full comfort
Autonomy all night long**
-  **Portable**
-  **No electrical wiring, no connection to the mains**
-  **Clever & multiple control options**
-  **Integrated solar panel**
-  **Powerful LED Light**
-  **Easy and fast installation**
-  **Separate Solar panel**





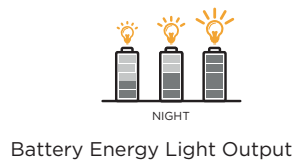
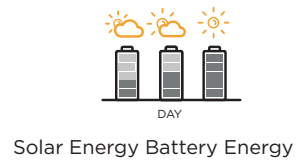

nice to know

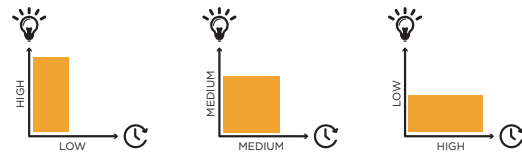









Longer light or more powerful light



-  High efficiency monocrystalline or polycrystalline solarpanel
-  LED module with strong light output: 100 lumen up to 500 lumen
-  Li-ion rechargeable battery included

-  Integrated dusk to dawn sensor, automatic switch to light-on during night
-  Weatherproof materials and finishing

how to choose

-  **solar panel Integrated**
Compact, no extra wiring
-  **Separate**
Higher solar energy capacity
-  **orientation of solar panel Fixed**
The luminaire should be placed in the most optimal position; south orientation
-  **Adjustable**
The panel can be oriented in the most efficient position; south orientation (tilt angle 35° in summer - 65° in winter)
-  **orientation of LED light Fixed**
Diffuse light - Up & down light
-  **Adjustable**
Directional spotlight
-  **clever control PIR motion sensor**
Smart use of the available solar energy
Always light when somebody is passing
-  **High-Medium-Low switch**
Personalized choice to come to ideal combination of light output and autonomy

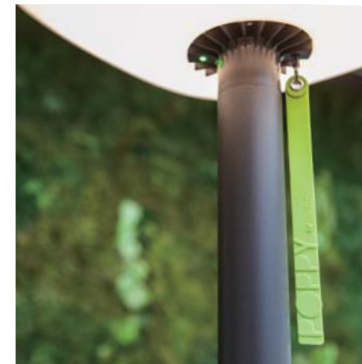

POPPY



poppy

portable post

All in one Solar lighting solution. Trendy & convenient design. Listen to your favourite music on your terrace or in your garden during a lovely summer night.



1	max 500lm	12H
2	200lm	16H
3	50lm	24H
4		OFF

6W
monocrystalline

6910802335

CLASS III
IP54
LED 8W
1*4400mAh 3.7V
Li-ion battery
500 Lumen
Synthetics

3000K

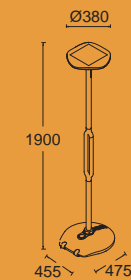



RGB

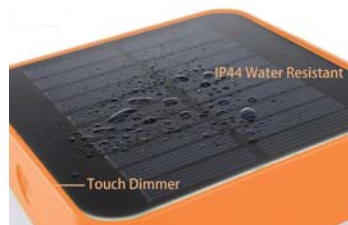

table cube

portable

Handy & movable outdoor solar table light. The 3 step dimmer will always give you the right atmosphere in combination with a sufficient autonomy.

Comes in 3 vivid colours & a stylish silver grey. Now also available in the colour changing RGB version. With the touch dimmer you can dim the white light or choose one of the 4 bright colours.



1	100lm	4H
2	40lm	10H
3	10lm	40H
4		OFF

1W
polycrystalline

1	100lm	4H			
2	10lm	40H			
3	4	5	6	7	4H
6					4H
7					OFF



-  **6908001337**
-  **6908001331**
-  **6908001339**
-  **6908001340**

 **6908003331**

CLASS III
IP44
LED 1W
1*1200mAh 3.7V Li-ion battery
100 Lumen
Synthetics

3000K

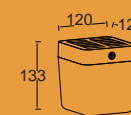

CLASS III
IP44
LED 1W
1*1200mAh 3.7V Li-ion battery
100 Lumen
Synthetics

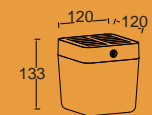
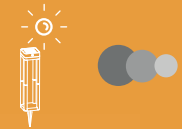



table cube

portable

Bring Solar light in every corner of your garden.
Bollard easily adjustable to full & medium height.
Ground spike included. Comes with a 3 step dimmer.



1	100lm	4H
2	40lm	10H
3	10lm	40H
4		OFF

1W
polycrystalline

6908002337

CLASS III
IP44
LED 1W
1*1200mAh 3.7V Li-ion battery
100 Lumen
Synthetics

3000K

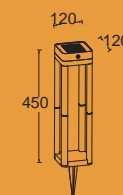



padlight

portable



Compact portable solar light. The ideal companion for your outdoor journeys. Versatile with multiple positions. Can be placed on a surface, hooked or suspended. The light panel radiates a very uniform light without any shadow. A 3-step dimmer with the possibility to optimise the light output & autonomy according to your needs. The USB cable (excluded) allows also to charge via an electrical network.



1.4W
monocrystalline



1	200lm	3H
2	80lm	9H
3	20lm	36H
4		OFF

-  **6907701331**
-  **6907701339**
-  **6907701340**

CLASS III
IP44
LED 2.4W
1*2500mAh 3.7V Li-ion battery
200 Lumen
Synthetics

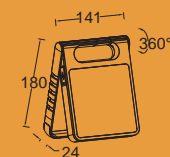



dragonFly

portable

In the "open" position this portable solar lamp will accumulate sufficient solar energy during the daytime or alternatively be charged through a built-in USB connector and included cable. In closed position it will give an inviting light when it is dark. Comes with 3 step dimmer. Available in 3 fresh colours.



1	120lm	4H
2	50lm	10H
3	10lm	40H
4		OFF

2*0.8W polycrystalline



- 6904101337
- 6904101331
- 6904101339

CLASS III
IP54
LED 1.2W
1*2200mAh 3.7V Li-ion battery
120 Lumen
Synthetics

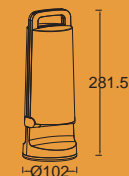



mini ledspot

integrated panel

Wall light with integrated solar panel, single head spot light version. This will assure you an optimal solar efficiency. The bright LED spotlight can be orientated in all directions. The three step dimmer offers you the choice between bright and long-lasting light.



1	100lm	6H	1.4W monocrystalline
2	50lm	10H	
3	30lm	21H	
4		OFF	

6914401000

CLASS III
IP44
LED 1W
1*2200mAh 3.7V
Li-ion battery
100 Lumen
Synthetics

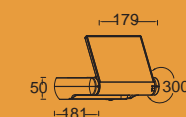



arrow

integrated panel

Very compact Solar wall light. The small size and light weight assures an easy mounting on the smallest surfaces. Sensor-switched and executed with an inclined solar panel for a better sunlight capture.



1W
polycrystalline

- | | | |
|---|----------|-----|
| 1 | 160times | ON |
| 2 | | OFF |

6910601335

CLASS III
IP44
LED 2.3W
1*1200mAh 3.7V Li-ion battery
180 Lumen
Synthetics

5000K

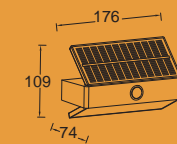



brick

integrated panel

Minimalistic design, easy installation on all different surfaces. Elegant built-in motion sensor with wide angle and large reach will capture every movement. Time & Light sensitivity regulation possible with levers at the inside.



- 1 120times AUTO
- 2 2h ON
- 3 OFF

1.5W polycrystalline

6908501308

CLASS III
IP44
LED 2W
1*2200mAh 3.7V Li-ion battery
150 Lumen
Synthetics

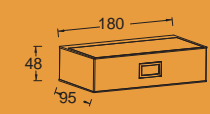



bread

integrated panel

Compact and easy to install solar wall light.
Fits perfectly to many different outdoor styles.
The built-in motion sensor assures you a welcoming



1	160times	AUTO
2	4h	ON
3		OFF

1W
polycrystalline



6901501000

CLASS III
IP44
LED 1.2W
1*2200mAh 3.7V Li-ion battery
100 Lumen
Synthetics

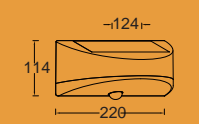



bubble

integrated panel

Half-globe solar light radiating a homogenous light. The PIR motion sensor, nicely incorporated in the stainless steel ring, will capture all movement and assures a powerful light any time somebody is passing throughout the night.



1	190times	AUTO
2	3h	ON
3		OFF



1.5W
polycrystalline

6908701001

CLASS III
IP44
LED 2.3W
1*2200mAh 3.7V Li-ion battery
200 Lumen
Synthetics





twill

integrated panel

Up & Down light feature, now also available in Solar version. Nice two direction & wide light beam on your wall. The integrated Solar panel is fully part of the design and completely out of view. Featuring a wide angle motion sensor.



1	120times	AUTO
2	27h	ON
3		OFF

1.5W
polycrystalline

6908901335

CLASS III
IP54
LED 2.2W
1*1200mAh 3.7V
Li-ion battery
200 Lumen
Synthetics

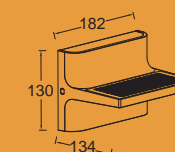



diso

integrated panel

Solar panel is perfectly integrated in the ingenious design. Ready to capture the full sunlight. Moveable head will orientate the light beam to the desired spot. The wall version comes with a PIR motion sensor which assures you a power full light any time someone is passing. Bollard version mountable with screws or with included ground spike.



1.5W
polycrystalline

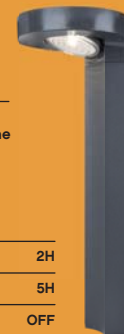

1	130times	AUTO
2	5h	ON
3		OFF



1	200lm	2H
2	100lm	5H
3		OFF



6906702335

CLASS III
IP44
LED 2W
1*2200mAh 3.7V
Li-ion battery
200 Lumen
Synthetics



6906703335

CLASS III
IP44
LED 2W
1*2200mAh 3.7V
Li-ion battery
200 Lumen
Synthetics





curtis

integrated panel

LED Solar wall light, with an opal diffuser and square aluminium frame.

The integrated PIR motion sensor will capture all movement and assures a powerful warm white light when somebody is passing throughout the night.



- | | | |
|---|----------|------|
| 1 | 140times | AUTO |
| 2 | 5.5h | ON |
| 3 | | OFF |

1W
polycrystalline

6934601118

CLASS III
IP54
LED 3W
1*1200mAh 3.7V Li-ion battery
300 Lumen
Synthetics

3000K

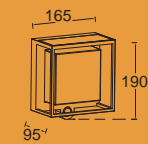



solstel

integrated panel

Solar wall light with an opal diffuser, gives a powerful and diffused light throughout the night thanks to the motion sensor option. The light part can be installed without any tools. The house number sticker set makes the package complete. The bollard version has the same functionalities and is easy to mount with screws or with a ground spike (included)

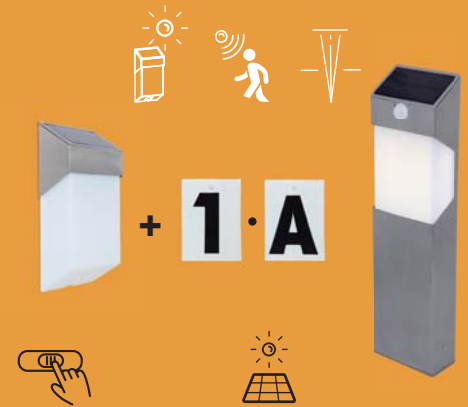

- | | | |
|---|----------|------|
| 1 | 150times | AUTO |
| 2 | 2.5h | ON |
| 3 | | OFF |

1W
monocrystalline

6907901000

CLASS III
IP44
LED 1.3W
1*1200mAh 3.7V
Li-ion battery
100 Lumen
Stainless steel



6907903001

CLASS III
IP44
LED 2.3W
1*1200mAh 3.7V
Li-ion battery
150 Lumen
Stainless steel

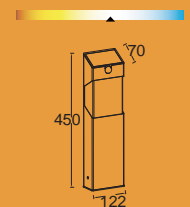



ghost solar

integrated panel

Sleek and elegant design. This wall washer with integrated solar panel and wide angle PIR motion sensor offers you a strong light when needed.



1	80times	AUTO
2	2h	ON
3		OFF

1.5W
polycrystalline



6901401337

CLASS III
IP44
LED 2.4W
1*2200mAh 3.7V Li-ion battery
260 Lumen
Synthetics

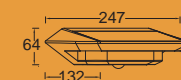



zeta

integrated panel

This wall light offers you the complete freedom to orientate the solar panel and the light panel in the optimum direction. In combination with the PIR motion sensors it will give a strong light to any outdoor space.



- 1 120times AUTO
- 2 2h ON
- 3 OFF



1.5W
polycrystalline

6901101000

CLASS III
IP44
LED 2.4W
3*1800mAh 1.2V
Ni-MH AA battery
200 Lumen
Synthetics

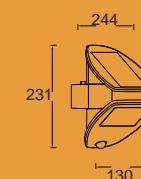



pole

The solar wall lights BREAD & ZETA can be mounted easily and without any tools on an independent post, creating a perfect bollard solution. The post can be screwed on a solid surface or put into the ground thanks to the included spike. The post contains 3 tubes giving the option to vary the height up to 1 meter.



9700308112

Color silver (si)
for
6901101000
6901301337
6901501000





tilly

integrated panel

A slim, futuristic design. The sleek adjustable spot heads can be orientated under the solar panel surface, giving multiple directions and powerful light beams. In combination with the subtle and centrally positioned PIR sensor, it will detect any movement throughout the night and will illuminate any foreseen or unforeseen guest.



1	120times	AUTO
2	2h	ON
3		OFF

3.5W
polycrystalline

6901201000

CLASS III
IP44
LED 4W
1*2200mAh 7.4V
Li-ion battery
420 Lumen
Die Cast Aluminium

4000K

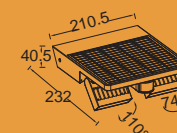



london

integrated panel

Classic 6 side lantern powered with Solar energy. The almost invisible Solar panel at the roof of the lantern has a large capacity, with an autonomy of more than 10 hours during night time. Comes with 3 retrofit filament bulbs, creating a warm & gentle light. The die-cast aluminium post can be mounted on a paved surface thanks to the included metal mounting bracket. For unpaved surfaces, you can use the special spike, available as an accessory.



 6W Monocrystalline 	Estimated Light Run Time for Different Seasons		
	Winter	Spring	Summer
 300 lumen	(101W/h) 03h40	(332W/h) 08h00	(603W/h) 10h00
Actual run time may vary depending on your specific location			

6951301189

CLASS III
IP44
LED 6W E12/incl.
1*2200mAh 7.4V
Li-ion battery
300 Lumen
Die Cast Aluminium

2700K



9700359330

Synthetics

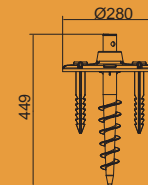

9700357000

LED 2W
250 Lumen

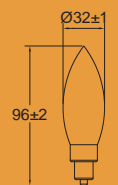



Wiring system

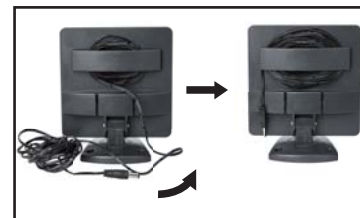

sunshine

independent panel

Elegant & powerful flood light offers a complete solution wherever there's no electrical power connection available. Ideal for illuminating your courtyards & driveways. The separate moveable solar panel comes with a 5 meter connection cable and can be positioned on the best spot to capture sunlight. Featuring an adjustable (time & distance) PIR motion sensor.



6925601345

CLASS III
IP44
LED 7.5W
1*2200mAh 3.7V
Li-ion battery
500 Lumen
Synthetics



1 240times 30S



1.4W polycrystalline
(5 meter cable)

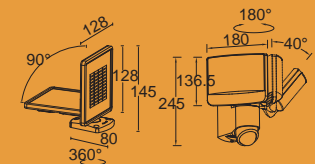



sunshine

independent panel

This wall light offers a complete security light installation without any wiring to the electricity network. The separate adjustable solar panel with its 5 m cable can be positioned on the optimum spot to capture sunlight all day long.

Comes with an adjustable (time & distance) PIR motion sensor. The movable spot head will give more than 350 lumen.



6901601000

CLASS III
IP44
LED 3.2W
1*2200mAh 3.7V
Li-ion battery
360 Lumen
Synthetics

4000K



1	120times	ON
2		OFF



1.5W polycrystalline
(5 meter cable)

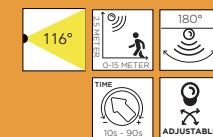
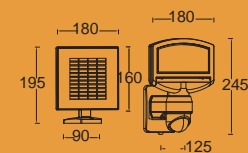

Wiring system

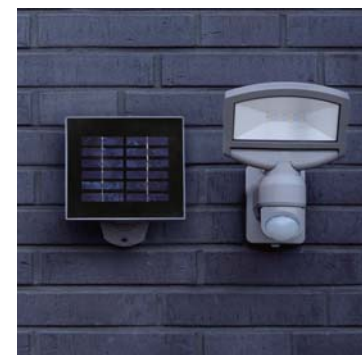
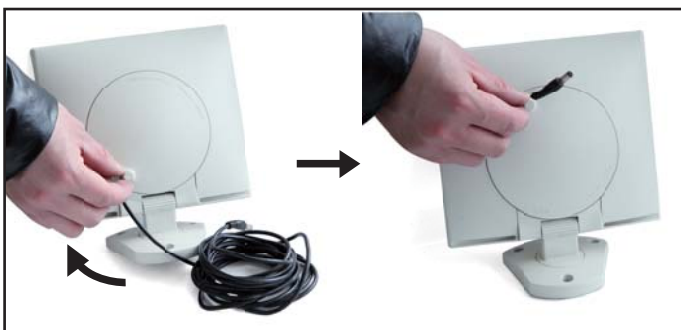

security for your **comfOrt**

SECURITY consists of a versatile range focussing on safety applications around homes.

The **InMotion concept** offers a complete range of Security Sensor Lights, featuring powerful flood lights and a number of elegant wall lights. The integrated PIR-sensor equipped with multiple parameter settings enables the installation of a perfect detection system.

The **SECURY'LIGHT concept** and the new **CAMERA LIGHT concept** presenting outdoor luminaires with an integrated connected camera, fully controlled through the LUTEC app's running on smart devices.

camera



ESA
7625501118 / P237



ESA
7625501053 / P237



PERI
7629502335 / P239



LIBRA
7632401053 / P241



VESTA
5190601118 / P243



ELARA
5267101001 / P245



ELARA
5267101118 / P245



NEW
MIMO
5194901118 / P251



NEW
MIMO
5194901053 / P251



NEW
POLLUX
5196001118 / P253



NEW
DRACO
7622206012 / P255



NEW
ARA
5198801330 / P257

wall



MAYA
5198401001 / P263



FARELL
5194801001 / P265



FARELL
5194802001 / P265



QUBO
5193002118 / P267



LEDA
5267103001 / P269



CYRA
5198102118 / P271

flood



PERI
7629401331 / P273



PERI
7629501331 / P275



SUNSHINE
7625601345 / P277



SUNSHINE
7625701345 / P277



ARC
7632201053 / P279



SHRIMP
7621902012 / P281



SHRIMP
7621903012 / P281



SHRIMP
7622104330 / P281

sensor



SPHERE
9701601330 / P283



TORUS
9701501330 / P285



 **SECURY'LIGHT**
connected camera concept



Have full control with the fully adjustable app.

Feel safe with the comfortable feeling that SECURY'LIGHT keeps an eye on your home.

With SECURY'LIGHT everything is under control.



Get live notifications from what's happening at your home. Talk to your visitors and feel secure.

You can even take a picture or record a video from wherever you are.

Listen and talk live with your visitors.



You can record a video or go back in time. And you can remotely set of an alarm buzzer.



Get an alert whenever someone approaches your home.



The light automatically jumps on where there is motion detected.

SECURY'LIGHT will keep an eye on your home

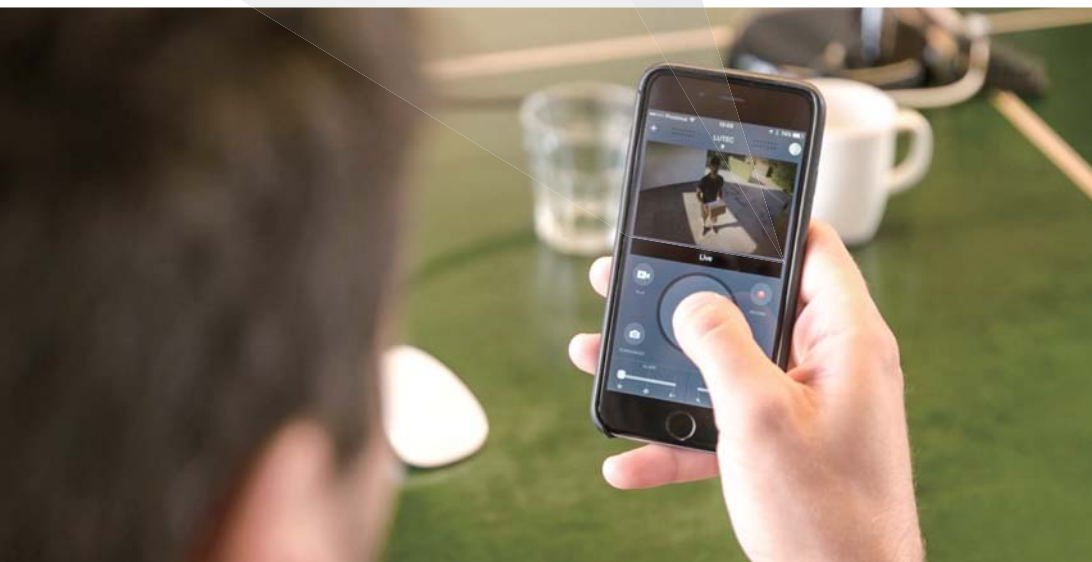

«When light meets a camera,
when light means security»



ALL CONTROLABLE IN ONE APP,
WHERE EVER, WHEN EVER.



Powerful and bright light with
the dimmable LED module



Sharp HD video recording with
wide angle light sensitive lens



Built-in noise cancelling microphone
with 2-way speaker buzzer



Infra-red motion sensor
fully adjustable in time,
distance and light mode



App with live motivations and video feed
Full control on all settings



Easy installation
WiFi connection



INSTALL

Quick install

Automatic Plug-in

DOWNLOAD

Download on the App Store
GET IT ON Google play

ENJOY

Pre-installation

- Download the APP.
- Ensure SECURY'LIGHT location has good Wi-Fi reception
 - Note: even small change in position can improve the reception

Set up

-
- Connect white red indicator light is flashing and after hearing "wait be configured"
-
-
-

Control

3 predefined presets for LOW-MEDIUM-HIGH security

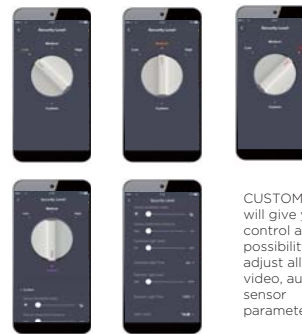

CUSTOM setting will give you full control and possibility to adjust all light, video, audio & sensor parameters.

Support

Via the "support" button you can access to all further Information & FAQ.



Please check out operation video
(installation, set-up & use)

YouTube <https://youtu.be/jEIA3FYe-NQ>

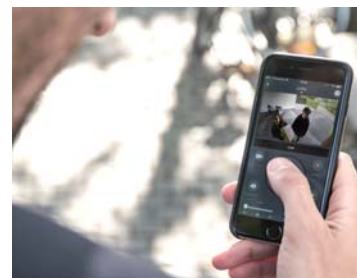

esa

wall

Techno look projector in the SECURYLIGHT range. Sleek design with 3 distinctive linear & diuse beams. The automatic plug-in connection allows a simple & easy installation. Fully orientable over two axes. Up-Down & Left-Right. Comes in white & dark grey colour.



7625501118
7625501053

CLASS II
IP54
LED 25W
1530 Lumen
Die Cast Aluminum

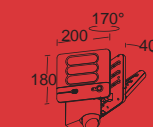



peri

wall & ceiling

Rectangular floodlight in the SECURYLIGHT range. Powerful LED light beam with a nice grid patter. The automatic plug-in connection allows a simple & easy installation. Fully orientable over two axes. Up-Down & Left-Right. Comes in white & dark grey colour.



7629502335

CLASS II
IP44
LED 25W
2120 Lumen
Synthetics

A+

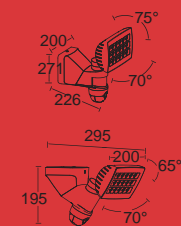



libra

wall & ceiling

Double head projector in the SECURYLIGHT range. The two "wings" feature a diffusor surface without edges, resulting in a perfectly homogeneous light beam. The automatic plug-in connection allows a simple & easy installation. The multiple orientation possibilities will give you full flexibility to cover the desired area.



7632401053

CLASS II
IP44
LED 38W
3000 Lumen
Synthetics

A+





vesta

wall

Stainless Steel wall light in the SECURYLIGHT range. Elegant & sleek design with rectangular diffusor. Radiates in a warm white light without shadows. Camera, Speaker, Microphone & PIR motion sensor are fully integrated in the fixture.



5190601118

CLASS I
IP54
LED 30W
1350 Lumen
Stainless Steel

A+

3000K



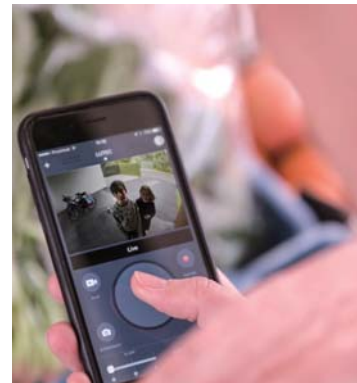

elara

wall

Tubular stainless steel wall light in the SECURYLIGHT range. Familiar design for entry-door application, with perfect finish and appropriate combination of the used materials. Warm white LED light without shadows. Camera, Speaker, Microphone & PIR motion sensor are fully integrated in the fixture.



5267101001

CLASS II
IP44
LED 18W
1200 Lumen
Stainless Steel

A+

3000K



5267102118

CLASS II
IP44
LED 18W
1200 Lumen
Stainless Steel

A+

3000K





always connected with your home

As market initiator LUTEC is proud to present the 2nd generation of the connected camera range.

This brand new range has been developed based on learning and consumer insights over the last 3 years and by applying the gains and innovations of the fast evolving connected technology.

This has resulted in a limited range of compact and very convenient camera lighting fixtures, ready to install or to make a swift replacement of your actual outdoor luminaires.

CAMERA LIGHT

connected security concept



LIGHT



CAMERA



AUDIO



DETECTION





ALL CONTROLABLE IN ONE APP
WHERE EVER, WHEN EVER.

Powerful and bright light with the dimmable LED module

Sharp HD video recording with wide angle light sensitive lens

Built-in noise cancelling microphone with 2-way speaker buzzer

Infra-red motion sensor fully adjustable in time, distance and light mode.

App with live notifications and video feed. Full control on all settings

WiFi connection
Secured Cloud Data Storage
Voice Control



install



download



enjoy

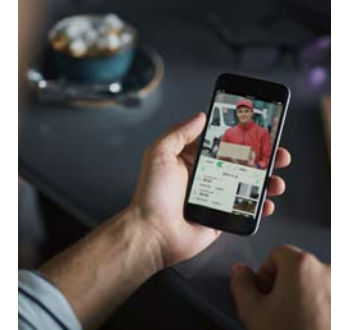

PRE-INSTALLATION



 WiFi >2 Mbps
2.4G ✓ 5G ✗

Ensure CAMERA LIGHT location has good Wi-Fi reception.

CONNECTION

Make sure the device is in red light slow flashing mode.

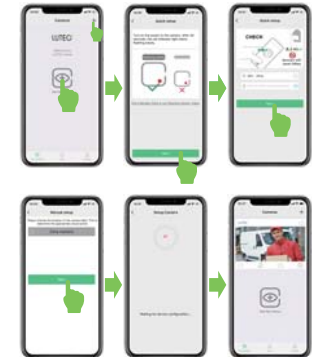

CONTROL



Complete setting menu to control all your personal adjustments for the light, video, audio & sensor parameters

VOICE CONTROL



"Hey Google" "Alexa" CAMERA LIGHT assists the Voice control protocols of the Google Assistant & Amazon Alexa



CLOUD STORAGE



Cloud storage of all your video's. Safe, Reliable and always accessible. Convenient registration. Three different Cloud Service Packs available at market level prices. Payable on monthly or annual base.

Google is a trademark of Google LLC. Amazon Alexa and all related logos are trademarks of Amazon.com, Inc. or its affiliates.



SUPPORT

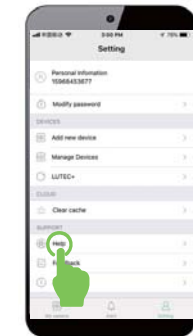

Via the "Help" button you can access to all further questions.

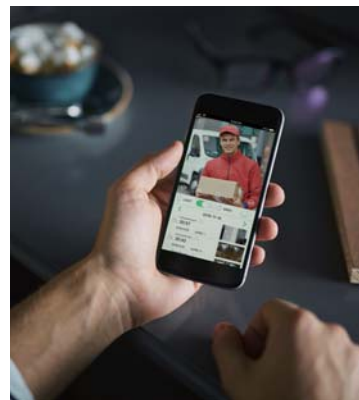

mimo

wall

Compact and sleek design. Easy replacement for the actual outdoor wall light next to your front door. Light, audio, video and detection all controllable in one App.



5194901053
5194901118

CLASS I
IP54
LED 18W
1200 Lumen
Synthetics

A+

3000K

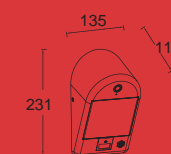

pollux

wall

Compact and elegant aluminium wall light. The tubular design makes a good fit at your front or back door. Features an integrated camera, speaker, micro and motion sensor all controllable in one App.

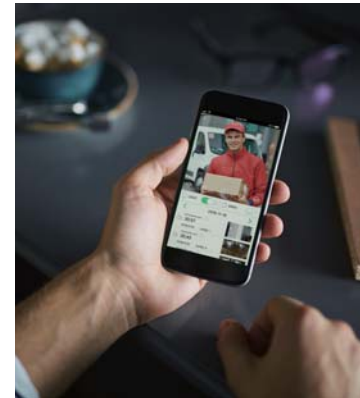

5196001118

CLASS I
IP54
LED 22W
1200 Lumen
Die Cast Aluminium

A+



3000K





draco

wall

Double head projector with multiple orientation possibilities give you full flexibility to cover the desired area. Comes with light, audio, video and detection all controllable in one App.



7622206012

CLASS I
IP54
LED 20W
1200 Lumen
Die Cast Aluminum

A+

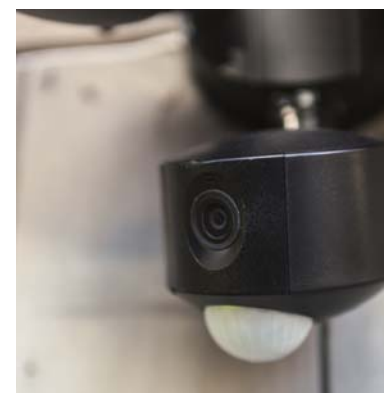
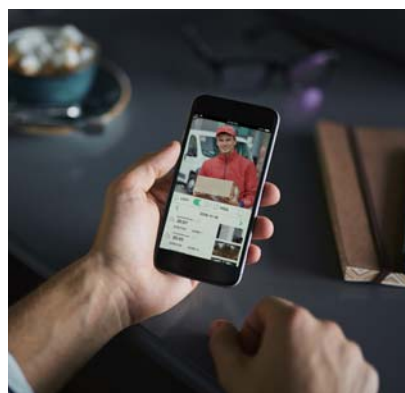
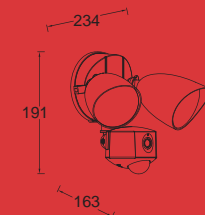

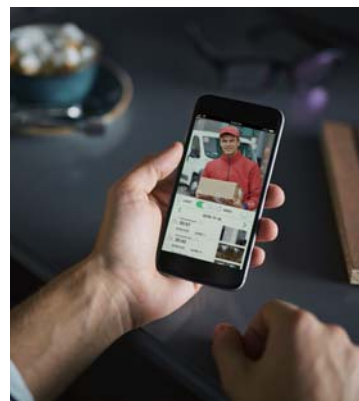

ara

wall

Compact orientation light that will guide you perfectly to your home entrance. Features an integrated camera, speaker, micro and motion sensor all controllable in one App.



5198801330

CLASS II
IP44
LED 4.5W
80 Lumen
Synthetics

A+



3000K

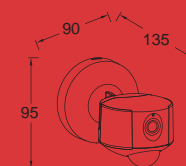



InMotion

Security Sensor Light

security for your **comFort**

LUTEC launches the InMotion concept offering a complete range of Security Sensor Lights.

The range is featuring now, besides the powerful flood lights with one or two heads, a number of very elegant designs which make a perfect match with the architecture of your house. The 2 stand-alone PIR sensors with multiple controls make the range complete.



Passive infrared (PIR) motion sensor

How does it work?

A PIR sensor detects changes in the amount of infrared radiation and converts this changes into a switch-on signal.

When a person makes a movement within the detection reach, the sensor will detect a difference in infrared radiation in between the person's body and the environment.



Comfortable detection area

The detection area is a combination of the reach in distance and angle. An adjustable sensor can be tilted and/or turned and gives you full freedom.

Your personal settings

Time setting

As from the moment the sensor detects a movement the light stay on from 10 seconds upon 8 minutes according your preference.



Twilight setting

The environment brightness can be adjusted according your selection from night (10 lux) to daylight. In this way the light will switch into the "ON" position according the selected outside light level and not during the day.



Distance setting

You can limit the detection distance in accordance with the desired detection area. In this way you can avoid a movement detection outside your private grounds.



For your convenience

Dusk to dawn

Automatic light on switching as soon it's dark outside



Ambient Light

Light stays on all night long in a gentle ambient light, after movement detection the light switches on a powerful light beam.

Double sensor

Assures you a full detection not only frontal but also underneath the luminaire close to the wall.

Test mode

You can define the perfect detection area during installation in daylight situation

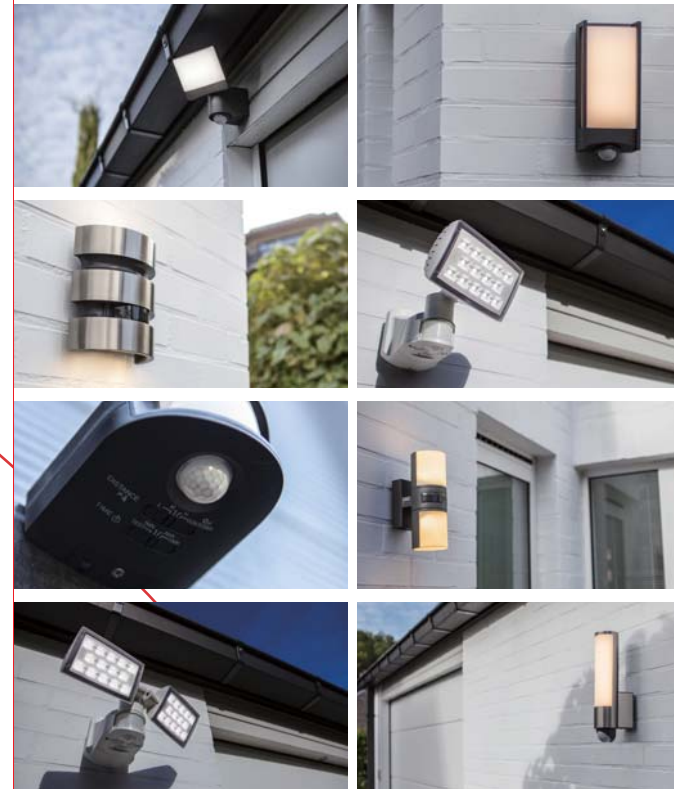

How to choose?

Check in a few steps which InMotion Security Sensor Light suits the best for your home situation.



BASED ON SENSOR DETECTION REACH

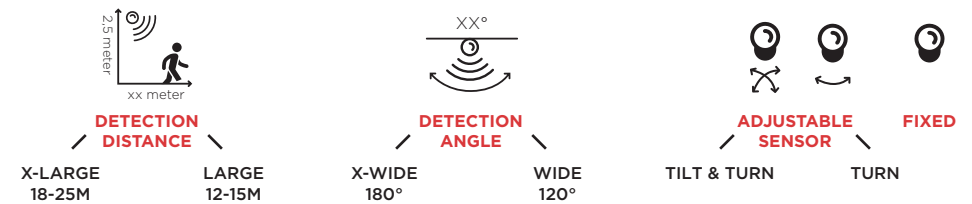

BASED ON LUMINAIRE CHARACTERISTICS

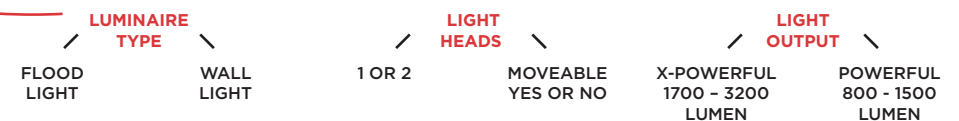

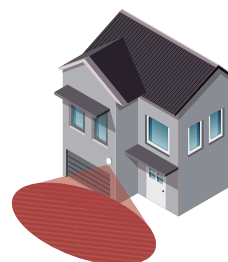

maya

wall

This compact Up & Down wall light with wide beam in aluminium with stainless steel cover has a timeless design. Discrete position of the black adjustable PIR motion sensor, makes it almost invisible.

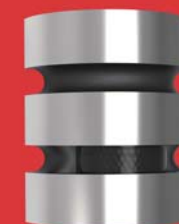

5198401001

CLASS I
IP44
LED 15W
1000 Lumen
Stainless Steel

A+

3000K

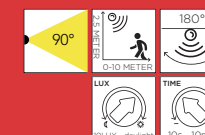



Farell

wall

Robust yet elegant stainless steel wall light, big surface diffuse warm white light radiation. Comes with performant motion sensor with a large detection reach and multiple control possibilities.



5194801001

CLASS II
IP44
LED 14W
700 Lumen
Stainless Steel

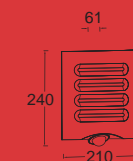

5194802001

CLASS II
IP44
LED 14W
900 Lumen
Stainless Steel

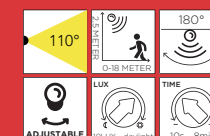
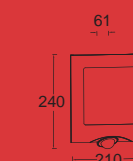



qubo

wall

With this wall light it is always pleasant to come home. Thanks to the performant integrated motion sensor, the visitors to your home will be detected from a distance and light will automatically switch on.



5193002118

CLASS I
IP54
LED 13W
800 Lumen
Die Cast Aluminum

A+



114°	180°
ADJUSTABLE	10s - 8min
LUX	10LUX - daylight
180°	0-18 METER



leda

wall

Tubular stainless steel wall light in the InMotion range contains a horizontal and vertically adjustable motion sensor. Thanks to the integrated sensor the light will automatically illuminate as soon as you get closer.



5267103001

CLASS II
IP44
LED 14W
1200 Lumen
Stainless Steel

A+

3000K



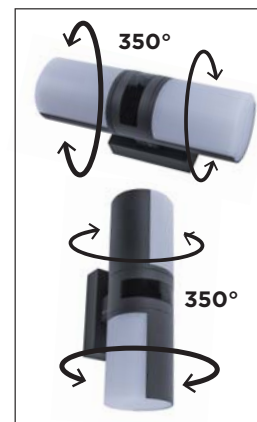

cyra

wall

Tubular wall light with a combination of anthracite grey aluminium body and opal white diffuser. The two moveable heads offer you a 350° rotation possibility resulting in a nice glow on your external wall or a frontal diffuse lightbeam. Comes also in a motion sensor version.



5198102118

CLASS I
IP54
LED 15W
1000 Lumen
Die Cast Aluminium

A+

3000K

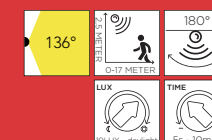
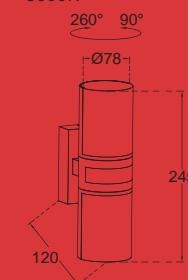



peri

wall & ceiling

The new version of security floodlight has a very powerful LED with a double adjustable motion sensor. Front sensor has a detection range up to 20 meters, the sensor covering the area under the floodlight detects movement close to the wall. The PERI series is easy to install and no tools are needed, comes in a single and double headed spot and is suitable for wall and ceiling mounting thanks to the rotating base."

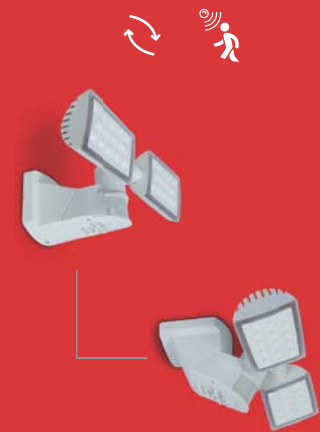

7629401331

CLASS I
IP54
LED 32W
3280 Lumen
Aluminium+Synthetics

A+

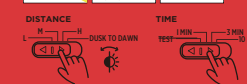
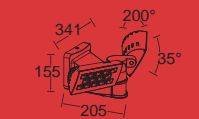

Quick install

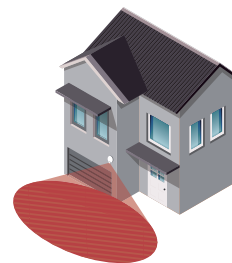



peri

wall & ceiling

The new version of security floodlight has a very powerful LED with a double adjustable motion sensor. Front sensor has a detection range up to 20 meters, the sensor covering the area under the floodlight detects movement close to the wall. The PERI series is easy to install and no tools are needed, comes in a single and double headed spot and is suitable for wall and ceiling mounting thanks to the rotating base."



7629501331

CLASS I
IP54
LED 16W
1710 Lumen
Aluminium+Synthetics



Quick install





sunshine

wall

Elegant & powerful flood light, ideal for illuminating larger areas as your courtyards & driveways.

The rectangular head can be directed over 2 axes. Comes with a high quality and fully adjustable PIR motion sensor with a detection reach up to 18 meter.

Now also available in compact version - 800 lumen.



7625601345

CLASS II
IP54
LED 16.5W
1200 Lumen
Synthetics

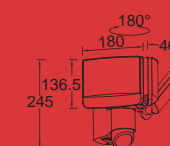

7625701345

CLASS II
IP44
LED 12W
800 Lumen
Synthetics

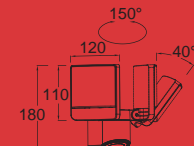

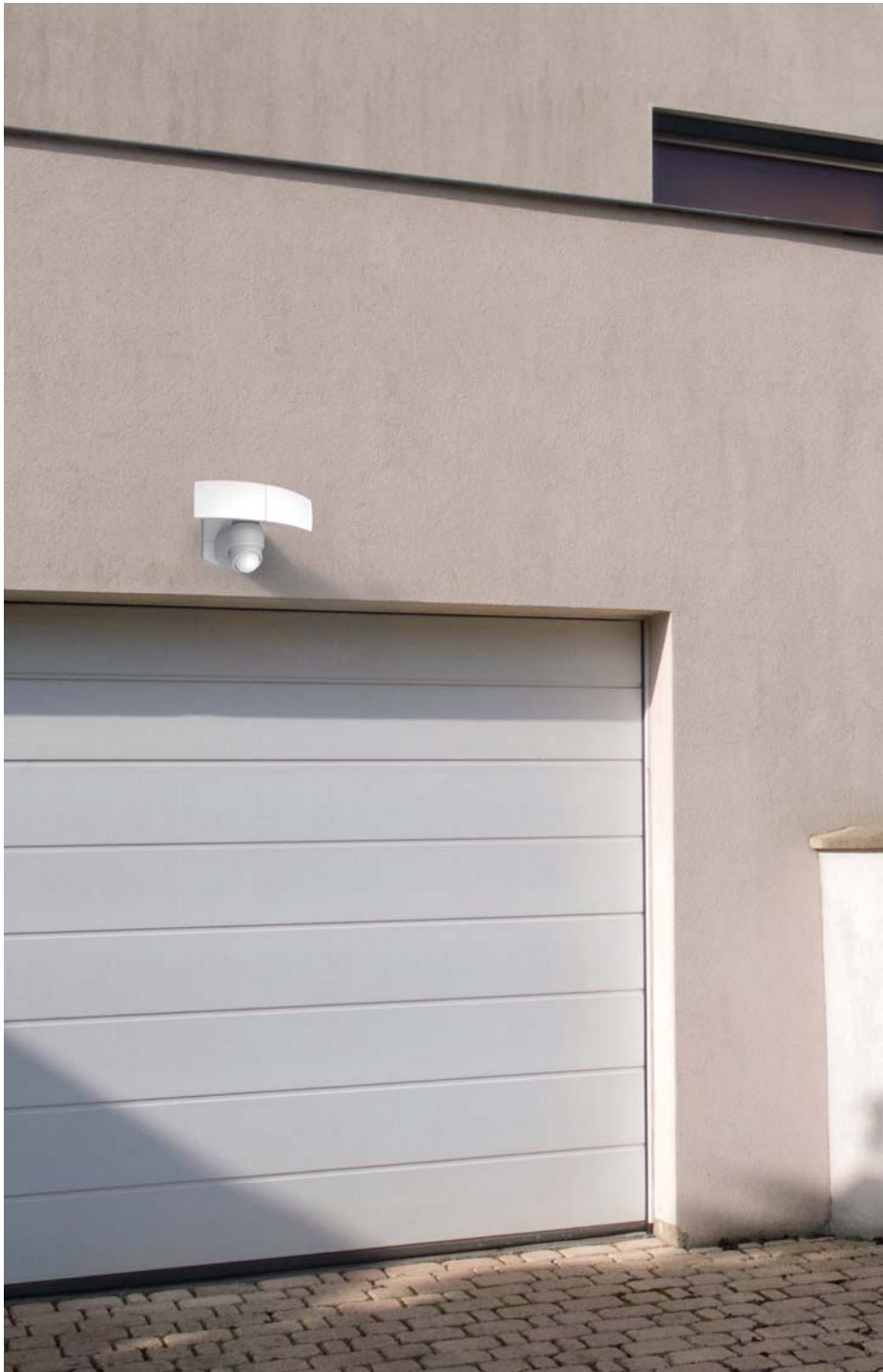

Quick install



arc

wall & ceiling

Elegant double head projector with fully adjustable motion sensor. The two "wings", feature a diffuser surface without edges, resulting in a perfectly homogeneous light beam. The multiple orientation possibility gives you full flexibility to cover the desired area.



7632201053

CLASS I
IP54
LED 19W
1200 Lumen
Synthetics

A+

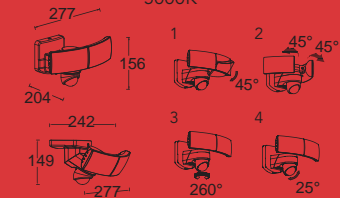



shrimp

wall & ceiling

Elegant yet powerful security floodlight with typical "bike lamp" design.

This series is available with or without adjustable PIR motion sensor.



7621902012

CLASS I
IP54
LED 22W
1380 Lumen
Die Cast Aluminum

A+

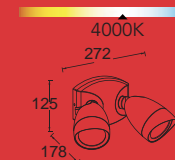

7621903012

CLASS I
IP54
LED 22W
1380 Lumen
Die Cast Aluminum

A+

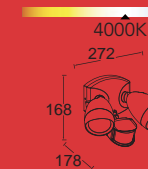

7622104330

CLASS II
IP54
LED 15W
1360 Lumen
Synthetics

A+

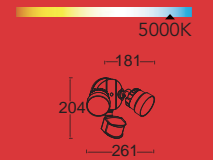



sphere

sensor

Stand alone passive infrared motion sensor.
Compact, orientable version with detection
range up to 12 meter and detection
angle of 180°.



9701601330

CLASS II
IP44
MAX 1100W
Synthetics

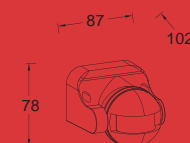

LUX
10LUX - daylight

TIME
10s-12min

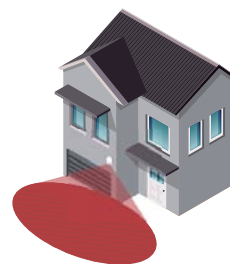

torus

sensor

Stand alone double and adjustable motion sensor. The frontal sensor has a detection range of up to 21 metres & 270°. The second sensor covering the area underneath detects any movement close to the wall.



9701501330

CLASS I
IP44
MAX 1000W
Synthetics

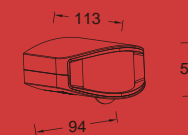

better light better work

SECURITY consists of a versatile range focussing on **WORK LIGHT** products are used in all kinds of workshop, garages, construction sites, decoration projects, outside and inside.

To meet demand, LUTEC has designed a complete range, from small portable lamps to tripods equipped with multiple light heads. From small to large, from domestic to professional. Bright and easy to use, to install and transport.

work light



UTIN
7629701341 / P291



MODO
7633301118 / P293



PERI
7629301341 / P295



PERI
7629001341 / P297



PERI
7629002426 / P297



utin

portable

Compact portable LED work light,
great look and striking colour combination.
Easy to store and transport.
Your perfect companion for all your DIY projects.
Comes with a 1.8m cable and plug.



7629701341

CLASS I
IP54
LED 11W
1040 Lumen
Die Cast Aluminum

A+

5000K

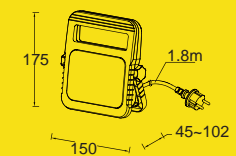



modo

portable

Portable work light with a distinctive but functional design. The yellow corner parts including the soft touch handle will protect the luminaire when falling. Including a 2.5 meter wire and plug.



7633301118

CLASS I
IP54
LED 21W
1500 Lumen
Die Cast Aluminum

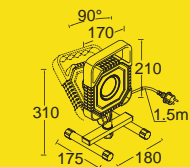



peri

portable

Portable version of the PERI range. Featuring the same 2 powerfull LED spotlights. Both easily adjustable in any desired direction. Practical handle and easy wiring sytem for 1.5m electrical cable.



7629301341

CLASS II
IP54
LED 21W
2000 Lumen
Synthetics

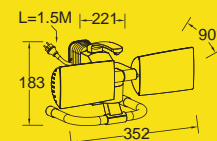



peri

portable

Re-invented, the double headed PERI LED Tripod floodlight. It's easy to transport when it's closed thanks to the practical handle, 2.5m cable wrap and compact dimensions which makes the installation logical and fast. The lock system, telescopic and manual, ensure in no time a stable and height-adjustable build up. Both adjustable spot heads have 2 rotation axes.



7629001341

CLASS II
IP54
LED 35W
3200 Lumen
Synthetics

A+

5000K

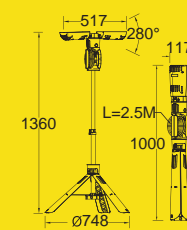

7629002426

CLASS I
IP54
LED 92W
7000 Lumen
Die Cast Aluminum

A+

5000K

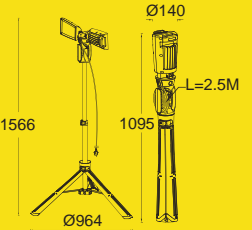

FUNCTIONAL consists of a wide range of recessed solutions: outdoor walls, wooden or stone terraces, driveways and pathways.

The recessed luminaires for wall (IP65) and ground (IP67) mounting are covering all standard applications. This with multiple light source possibilities, coming in wide flood or narrow spot light beam. Small, medium and large sizes in fixed or adjustable versions.

where function
meets **form**

recessed ground



BERLIN
7700511012 / P303



STRATA
7704601012 / P305



CYDOPS
7704212012 / P307



DENVER
7704801012 / P309



ARCTIC
7701301012 / P311



berlin

recessed ground

Round stainless recessed ground spots creating a nice effect to guide you along your driveway, pathway or terrace. Compact in size yet solid in construction, you can drive over it with a car.



Car can drive over



7700511012

CLASS I
IP67 & IP65
GU10 35W
Stainless Steel





strata

recessed ground

Compact recessed spot with opal diffuser creates a homogenous warm white light. For your installation convenience the stainless steel ring can be mounted separately. The limited built-in height makes it very suitable for wooden outdoor terraces.



7704601012

CLASS I
IP67 & IP65
LED 9.2W
320 Lumen
Stainless Steel

A+

3000K

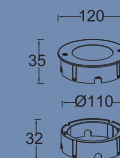



cydops

recessed ground

Super compact stainless steel recessed ground spot with a wide angle. High light efficiency combined with only a shallow recess needed for installation makes this built-in spot perfectly suitable for your wooden terraces.



7704212012

CLASS I
IP67 & IP65
LED 8W
580 Lumen
Stainless Steel

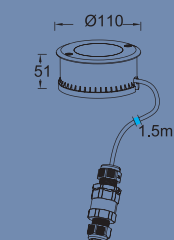



denver

recessed ground

Medium size stainless steel ground recessed spot.
Can be built in a paved or unpaved surface.
Features a wide angle and very powerful 1000
lumen light beam.



7704801012

CLASS I
IP67 & IP65
LED 12W
1030 Lumen
Die Cast Aluminum

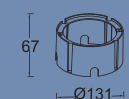
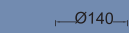



arctic

recessed ground

Robust, powerful yet compact recessed LED ground spot with a limited build-in depth. This spot can be inclined up to an angle of 75°. Pick out ornaments, trees and bushes in your garden with a stunning light effect.



7701301012

CLASS I
IP67 & IP65
LED 12.5W
650 Lumen
Die Cast Aluminum

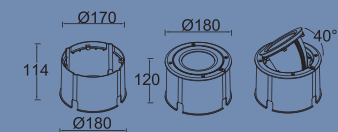

introducing our company

40 years of experience

The beginnings of a lighting company

Originally set up as a national aluminium die-cast factory, we gained our first experience of outdoor lighting by producing bulkhead lights & classical garden lanterns. Our quality standards have always met international standards and the first export shipment was made in 1996. The new factory in Yuyao became operational in 2001, concentrating on modern garden & professional lighting resulting from a booming international demand. From 2009 a close collaboration with the Design(Pool) had two objectives; to create a stronger offer for the ODM market and to develop a platform for our own brand of lighting. LUTEC was launched in 2010, focusing on architectural LED lighting and the introduction Solar Energy Products. The success of the company resulted in the opening of a second production facility in 2012, fully devoted to future developments in design and new technologies.



Nowadays Lighting is both essential and magic.

The challenge of lighting market is to create products which are a balance between the shape, impact and attractiveness however, they must also provide real functional values. The LED revolution has completely changed the game, giving many new opportunities. Added to this we must not only continue to offer the latest technical innovations but also anticipate and provoke them, especially with solar energy and smart lighting controls. To serve our objectives, we have continued to expand our international network and organisation: with new central warehouses in Belgium and China, establishing partners in many new countries allowing us to continue building our corporate identity and providing our partners with unique product support and marketing.

Future is already here Support the users

Today we are all surrounded by the interactive and connected World. For many reasons it is evident that the lighting market must also embrace this new internet age. The need to control our lighting, at will, from afar and to suit our environment is a must have feature. Temperature, color, dimming, activity sensors and timing controls are the norm. Programmable solutions for energy saving, interactivity between multiple light points or installations are becoming standard. Security options with camera vision, live video and recording are no longer a futuristic dream as LUTEC products can perform all of the above.



Whilst it is true, LUTEC is a young brand, it is built on a strong manufacturing background (40 years of experience) and a solid reputation of technological expertise. Manufacturing involves imagination and efficiency.

Why we decided to establish a brand?

The brand gives us a needed visibility. The brand allows us to anticipate the market, to make our own choices related to trends and to make developments such as we perceive them through our partners in different countries. Connected by lighting underlines our intention to develop products in accordance with the final consumers, through all our network and distribution channels. Having become a major player in the lighting field, our main objective is to consolidate our offer through creativity, our designs evolve and involve the highest level of quality and services.

welcome to the lutec center

connected by lighting

The LUTEC centre is in our HQ in Yuyao and located on our production site, it is an International meeting venue where new concepts, innovation & strategies are studied then created and shared, with our partners.



We provide an expert platform in design, sales and services. We have the will to show and experiment different approaches creating choices for the short or medium terms. Staying close to our customers, which by extension also means the final consumers, allows the right design solutions to be found. Our team is trained to be proactive and reactive. The key to realise a win-win product is to always explore the possibilities, look outside the box to find the best solution.



In our view innovation is always closely linked to a right level of realization.

design & engineering

design, engineering & manufacturing, all interactive.

One of the main decision we have taken in the LUTEC organisation is to break down the walls between of each department to improve product strategy. This brings a culture of flowing communication between the services where everybody has a positive role to play in all projects. It works because we consider that we are all concerned in the success of a product.

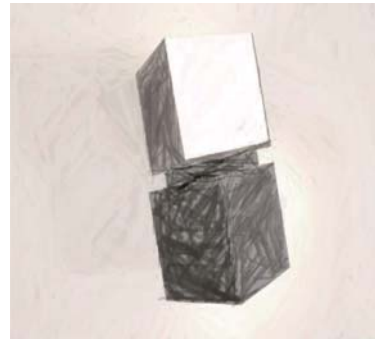
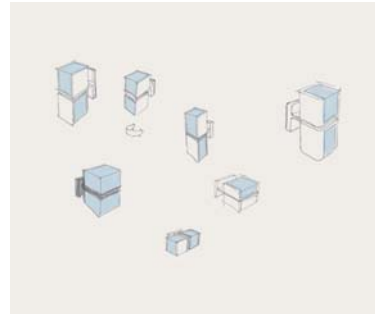

We all know development is complex with many obstacles to overcome however by working together helps our team to aim for the perfect solution as smoothly as possible. Knowledge is shared at all levels. Creativity, marketing, engineering, production, and sales are all one, this method improves time to market significantly.

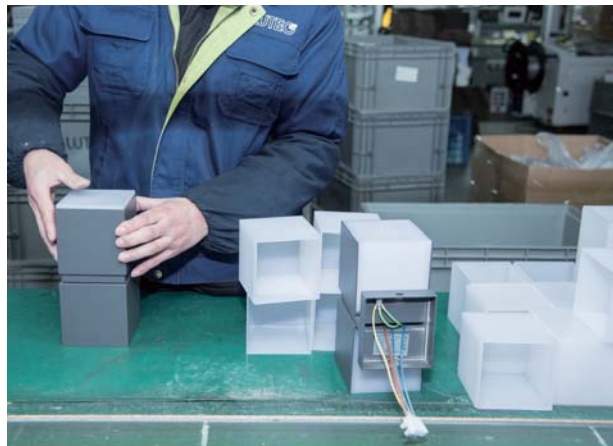

warehousing & transport

global logistic footprint assuring availability & proximity.



Unlike many manufacturers in this sector, LUTEC keep significant levels of completed stock which is packaged and ready to ship. This is in addition to our stock process flow, feeding our satellite distribution centres in Europe and elsewhere around the World. Our aim is to reduce the lead time wherever possible on key products.

CCW
China Central
Warehouse
Yuyao - China

ECW
European Central
Warehouse
Bornem - Belgium

Since 2014, the European Central Warehouse is fully operational. This warehouse located in Belgium, centrally situated in Europe with an average lead time of 7 days for most shipments within Europe, LUTEC products are always within reasonable reach. We offer different transport options: direct shipment, cross docking or pick-up, in co-operation with each territory. The ECW product portfolio now contains 200 sku's.

Now, we've also the possibility to assure different value adding trade marketing services in the ECW.



LUTEC quality



As a global supplier, our products are fully compliant with all relevant technical & quality requirements of the different regions in the world.



All LUTEC LED products benefit from a 5-years functional warranty. For the SOLAR range we apply a standard 2-years operational warranty.

Subject to conditions, please see our website.
www.lutec.com/warranty



Integrated LED Light-engines

In the majority of our ranges we use dedicated LED light engines. The LUTEC in-house engineering/production departments only use primary component suppliers, constantly improving the performance of the total LED product, resulting in a higher lumen/watt ratio as well as increasing levels of lumen/monetary ratio.

Low Energy Cost: LUTEC products offer at least an 80% saving compared to traditional sources
Long Lifetime: up to 20.000 hours

LUTEC LED-light engines featuring the most appropriate characteristics in order to give the best result for all your outdoor applications.

- Lumen Maintenance: 100% LM-80 test report
- Color deviation: 100% under 5-step MacAdam ellipse
- ERP compliant

The LED driver is the heart of the LED module and is the main influencer of the life-time. LUTEC develops these drivers to the specification of the product for best performance. The production of the SMD's used in the LUTEC-drivers is done in-house in our approved SMT assembly lines. All drivers are compliant to all relevant standard and regulations. UL-GS-EMC-FCC-ERP.



The **Light Color** or **Color Temperature** in Kelvin (K) gives a clear indication about "whiteness" of the LED light.

Standard we apply the 4000K Daylight. For most fixtures with diffuse light and vintage look a 3000K Warm White light is installed. The more functional work & security projectors have an integrated LED source with a 5000K Cool White light.

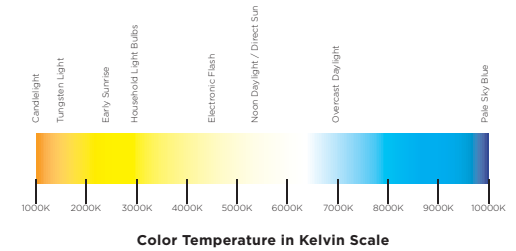

The **Color Rendering Index (CRI)** gives on a 0-100 scale an indication the color accuracy. Determining the ability of the light source to reveal the colors of the object faithfully in comparison with a natural light source. In all LUTEC fixtures we apply a CRI of minimum 80%. For outdoor applications this is an ideal level.

The **Luminous Flux** of an Outdoor fixture indicated by number of Lumen. (lm) is the total amount of light which comes out of the fixture in all directions. It gives a good measure of the brightness you can expect. This Lumen indication is a better way to describe the level of illumination as opposed to wattage.

	Standard	25 W	40 W	60 W	75 W	100 W
	Halogen	18 W	28 W	42 W	53 W	70 W
	CFL	6 W	9 W	12 W	15 W	20 W
	LED	4 W	6 W	10 W	13 W	18 W
	Brightness Lumen	220	400	700	900	1300

The **Luminous Efficacy** in Lumens/Watt gives a good measure of the optimal conversion of the electrical power into useful light. This is an important parameter with direct impact on the electric energy cost for your installation. Thanks to the continuous developments the LED solution is already today one of the most efficient light technologies. The Luminous Efficacy is one of the main parameters for the determination of the Energy Efficiency class.

According to the EU regulation no 874/2012, for energy labelling of electrical lamps and luminaires, requires manufacturers to inform consumers of the Energy Efficiency class.

LUTEC LED-fixtures are rated at a minimum **Energy Efficiency class of A+** or higher, further information is available on our website; www.lutec.com.

This luminaire contains built-in LED lamps.

Ce luminaire comporte des lampes à LED intégrées.

Esta luminaria lleva lámparas LED incorporadas.

Acest corp de iluminat este prevăzută cu lămpi cu leduri intergrate

LED

The lamps cannot be changed in the luminaire.

Les lampes de ce luminaire ne peuvent pas être changées.

Nie možna vymeniť lamp v oprave

Лампы светильника не могут быть заменены.

Las lámparas de esta luminaria no son reemplazables.

Lambalar armatürde değiştirilemez.

As lâmpadas não podem ser substituídas

Lămpile din acest corp de iluminat nu pot fi schimbate

Die Lampen können in der Leuchte nicht ausgetauscht werden.

II
I

materials & Finishes

LUTECH exterior products are produced using high quality materials and finishes with excellent weather protection properties as well as mechanical strength to ensure a long lifetime.

Heavy duty die-cast Aluminum (ADC 12) with a thickness of 2mm, is in most cases the preferred material, our process ensure no air holes. The LUTECH In-house fully automatic powder-coating & water painting installation provides excellent protection against corrosion.

LUTECH benefits from an in-house tooling workshop for both aluminum and synthetic components. This facility provides us with high quality production especially where premium Stainless Steel is used, typically in ground recessed spotlights using grade 304 & 316 steel. For the wall & bollards: 201 & 202 is utilised with an electrophoretic paint, resulting in an additional layer of protection.

Different kind of durable synthetics, depending on the application and form factors. For the fixtures: in most cases ABS, this is a strong, light-weighted material and can be used under low and high outdoor temperatures. For the diffusers: the impact proof and very resistant PC (polycarbonate) is used in opal or transparent version. Also clear glass, tempered glass and opal or clear PMMA (plexi-glass) are common in our designs.



mounting, installation & maintenance

Instruction Manual



LUTECH pays a lot of attention to a user friendly and effective yet simple instructions, we strive to find time saving methods of installation using uniquely designed interfaces where possible. Every LUTECH Outdoor fixture has a clear instruction manual in the unit box and this manual can also be downloaded from our website.

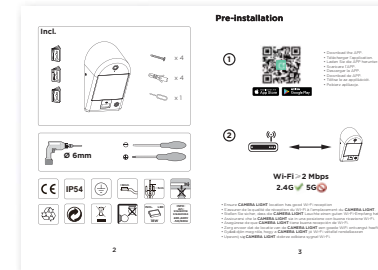

IP rating table

0	Protection against solids	0	Protection against liquids
0	Not Protected	0	Not Protected
1	Protected against Solid Objects greater than 50mm	1	Protected against Dripping Water
2	Protected against Solid Objects greater than 12mm	2	Protected against Dripping Water when tilted to 15°
3	Protected against Solid Objects greater than 2.5mm	3	Protected against Spraying Water
4	Protected against Solid Objects greater than 1mm	4	Protected against Splashing Water
5	Dust Protected	5	Protected against Water Jets
6	Dust Tight	6	Protected against Heavy Seas
		7	Protected against the effects of Immersion
		8	Protected against Submersion

The LUTECH Outdoor fixture comply to the International standards concerning Ingress Protection. All articles have a minimum IP44 rate. For some specific applications (Ex. in ground recessed spots) the protection rate goes up to IP67.

Color Indication

Color Indication
● Anthracite Grey
● Silver Grey
● Stainless Steel
● White
● Black
● Green
● Orange
● Black-Rust
● Yellow
● Bronze

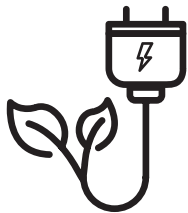

Sustainable vision

LUTECH constantly strives to reduce the impact of manufacturing on the environment, our intention to become a wholly sustainable company by continually improving our processes. All our designs start from a sustainable mindset, offering our customers low energy consumption LED- solutions or fully energy neutral SOLAR energy alternatives.



Service network



Our service network is available on global level through our LUTECH Partners. Contact details: www.lutech.com/services/global-network



LUTEC brand identity packaging

The LUTEC corporate identity has been revamped in line with our evolving brand values. New trade support tools and POS have been created to support our products and our customers providing an integrated selling solution, all of which adds value and distinguishes the LUTEC offer from our competitors.



2019 sees the introduction of the fully refreshed packaging, being applied to our complete portfolio. We believe the new look of the new packaging is fresh, vivid and in tune with our style of products.

The product is always the hero with an inspiring photography. The refreshed LUTEC logo is visible from all sides of the packaging which together with the green banner this will further improve the brand recognition. The most relevant characteristics (lifestyle) are shown on the front, top and second side, this is combined with an in situation image. The lifestyle image on the front is repeated on the third side and creates the right atmosphere for each product style. The rear of the carton contains comprehensive technical information utilising innovative graphic icons. The EEL label and the short description translation in 8 languages makes the information complete.

LUTEC brand identity rich content

We're constantly creating new communication materials to support and improve the presentation of LUTEC products, allowing ease of selection. All support materials are accessible through our refreshed website www.lutec.com. Where you can find the LUTEC database with all kind of "rich content": product photos, Lifestyle photo's, Tutorials, Inspirational video's, Flash-Intro video's, Unpacking experiences, etc.

All support materials may be used for numerous marketing initiatives such as driving traffic to your own landing pages on your websites via social media. Content can be created in a convenient and attractive way resulting dynamic information and content to inform and inspire the customers about the LUTEC products.

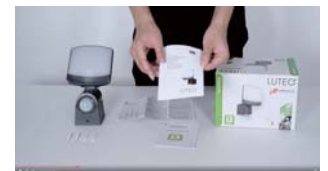
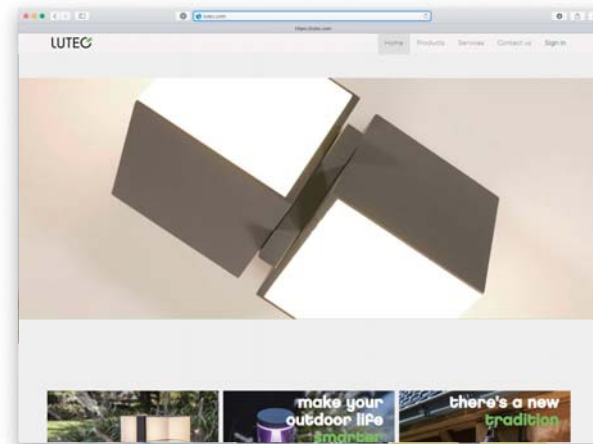

LUTEC brand identity

in-store support

Based on consumer insights and specific requests from our customers, we're proposing a large number of in-store support tools. Always starting from the same idea: the product - proposition is king, the customer should be guided in a clear way facilitating clear product selection in a convenient way. Together with the refreshed look & feel to the LUTEC brand communication, we have adopted an inspiring and convincing communication for the various product segments.



Index : as per NEW ITEM NO.

NEW ITEM	NAME	PAGE	NEW ITEM	NAME	PAGE	NEW ITEM	NAME	PAGE	NEW ITEM	NAME	PAGE
5033001001	FACE	85	5198102118	CYRA	49	6335142118	ORIGO	29	7198101118	CYRA	49
5033002001	FACE	85	5198102118	CYRA	271	6336201118	TITAN	143	7199201118	CRUZ	81
5183601118	CITY	105	5198104118	CYRA	51	6338201118	SEINE	145	7204803118	FOCUS	131
5184601118	BOX CUBE	103	5198302001	MAYA	121	6348011112	UBLO	141	7214603118	MINI LEDSPOT	55
5185701012	STARRY	165	5198401001	MAYA	121	6348102112	UBLO	139	7214604118	MINI LEDSPOT	55
5185901012	AQUARIUS	163	5198401001	MAYA	263	6350101112	UBLO	141	7216412118	MERIDIAN	67
5186902118	PILO	111	5198701001	WHISPER	71	6350102112	UBLO	139	7225201118	ANDA	63
5188003118	GHOST	69	5198801330	ARA	257	6382201118	ROLA	137	7260311012	UNITE	161
5188601125	BATI	93	5199001118	EKLIPS	47	6383001118	BULLO	135	7260311030	UNITE	161
5188602125	BATI	93	5199201118	CRUZ	81	6383001445	BULLO	135	7260401012	UNITE	161
5188801118	APOLLO	75	5240101012	ZOE	157	6402101118	HELENA	147	7260401030	UNITE	161
5189101118	GEMINI	117	5252101118	ANDA	63	6588801012	FLAIR	171	7264210213	CATE	177
5189102032	GEMINI	115	5260101012	UNITE	159	6609201118	EXPLORER	59	7264230213	CATE	177
5189102118	GEMINI	115	5260101030	UNITE	159	6609202118	EXPLORER	59	7271004118	SPICA	27
5189103118	GEMINI	115	5260103012	UNITE	159	6609204118	EXPLORER	35	7273601012	KELSEY	175
5189104118	GEMINI	119	5260103030	UNITE	159	6609205118	EXPLORER	35	7273602012	KELSEY	175
5189111118	GEMINI	33	5260201012	UNITE	159	6901101000	ZETA	217	7288601118	DAKOTA	23
5189112118	GEMINI	117	5260201030	UNITE	159	6901201000	TILLY	221	7288602118	DAKOTA	23
5189113118	GEMINI	115	5264201213	CATE	177	6901401337	GHOST SOLAR	215	7288801012	FLAIR	171
5189114118	GEMINI	119	5267101001	ELARA	245	6901501000	BREAD	203	7288901118	KIRA	21
5189501118	ZERTA	101	5267102118	ELARA	245	6901601000	SUNSHINE	227	7289001118	PANO	61
5189601118	TONA	99	5267103001	LEDA	269	6904101331	DRAGONFLY	195	7621902012	SHRIMP	281
5189602118	TONA	99	5271002118	SPICA	27	6904101337	DRAGONFLY	195	7621903012	SHRIMP	281
5189901118	SECO	87	5273601012	KELSEY	173	6904101339	DRAGONFLY	195	7622104330	SHRIMP II	281
5190601118	VESTA	243	5273701012	KELSEY	173	6906702335	DISO	209	7622206012	DRACO	255
5191601118	HELENA	147	5274601412	DARLI	179	6906703335	DISO	209	7625501053	ESA	237
5191602118	HELENA	147	5288601118	DAKOTA	23	6907701331	PADLIGHT	193	7625501118	ESA	237
5192701118	LEO	125	5288801012	FLAIR	167	6907701339	PADLIGHT	193	7625601345	SUNSHINE	277
5192701335	LEO	125	5288802012	FLAIR	167	6907701340	PADLIGHT	193	7625701345	SUNSHINE	277
5192801118	FACCIA	97	5288803012	FLAIR	169	6907901000	SOLSTEL	213	7629001341	PERI	297
5192901118	TANGO	91	5288804012	FLAIR	169	6907903001	SOLSTEL	213	7629002426	PERI	297
5193001118	QUBO	79	5288901118	KIRA	21	6908001331	TABLE CUBE	189	7629301341	PERI	295
5193002118	QUBO	79	5289001118	PANO	61	6908001337	TABLE CUBE	189	7629401331	PERI	273
5193002118	QUBO	267	5521201001	CRYSTAL	123	6908001339	TABLE CUBE	189	7629501331	PERI	275
5193003118	QUBO	25	5521601001	CRYSTAL	123	6908001340	TABLE CUBE	189	7629502335	PERI	239
5193201118	LOTUS	109	5604011118	FOCUS	129	6908002337	TABLE CUBE	191	7629701341	UTIN	291
5193602118	ADALYN	89	5604101118	FOCUS	129	6908003331	TABLE CUBE	189	7632201053	ARC	279
5193801118	CUBA	43	5605013118	FOCUS	133	6908501308	BRICK	201	7632401053	LIBRA	241
5193803118	CUBA	45	5605103118	FOCUS	133	6908701001	BUBBLE	205	7633301118	MODO	293
5194301118	ALICE	73	5605701112	PATH	127	6908901335	TWILL	207	7700511012	BERLIN	303
5194302118	ALICE	73	5605702112	PATH	127	6910601335	ARROW	199	7701301012	ARCTIC	311
5194801001	FARELL	265	5614401118	MINI LEDSPOT	53	6910802335	POPPY	187	7704212012	CYDOPS	307
5194802001	FARELL	265	5614402118	MINI LEDSPOT	53	6914401000	MINI LEDSPOT	197	7704601012	STRATA	305
5194804001	FARELL	31	5614404118	MINI LEDSPOT	53	6925601345	SUNSHINE	225	7704801012	DENVER	309
5194901053	MIMO	251	5616302118	MERIDIAN	65	6934601118	CURTIS	211	9700308118	POLE	219
5194901118	MIMO	251	5616304118	MERIDIAN	65	6951301189	LONDON	223	9700357000	LONDON	223
5195401118	QUBO	77	5626001118	TRUMPET	57	7188601125	BATI	95	9700359330	LONDON	223
5195801001	HILL	113	5626002118	TRUMPET	57	7193001118	QUBO	79	9701501330	TORUS	285
5196001118	POLLUX	253	5626101125	TRUMPET	57	7193002118	QUBO	25	9701601330	SPHERE	283
5196501118	URBAN	107	6304201118	FOCUS	131	7193801118	CUBA	43	9702201012	MAINS	151
5197002125	TELIN	83	6330401118	BONN	149	7193802118	CUBA	45	9702202012	MAINS	151
5198101118	CYRA	49	6330402001	BONN	149						

Index : as per SERIES NAME

NAME	NEW ITEM	PAGE	NAME	NEW ITEM	PAGE	NAME	NEW ITEM	PAGE	NAME	NEW ITEM	PAGE
ADALYN	5193602118	89	DRAGONFLY	6904101331	195	LIBRA	7632401053	241	SHRIMP	7621903012	281
ALICE	5194301118	73	EKLIPS	5199001118	47	LONDON	6951301189	223	SHRIMP II	7622104330	281
ALICE	5194302118	73	ELARA	5267101001	245	LONDON	9700359330	223	SOLSTEL	6907901000	213
ANDA	5252101118	63	ELARA	5267102118	245	LONDON	9700357000	223	SOLSTEL	6907903001	213
ANDA	7225201118	63	ESA	7625501053	237	LOTUS	5193201118	109	SPHERE	9701601330	283
APOLLO	5188801118	75	ESA	7625501118	237	MAINS	9702201012	151	SPICA	5271002118	27
AQUARIUS	5185901012	163	EXPLORER	6609202118	59	MAINS	9702202012	151	SPICA	7271004118	27
ARA	5198801330	257	EXPLORER	6609204118	35	MAYA	5198302001	121	STARRY	5185701012	165
ARC	7632201053	279	EXPLORER	6609205118	35	MAYA	5198401001	121	STRATA	7704601012	305
ARCTIC	7701301012	311	EXPLORER	6609201118	59	MAYA	5198401001	263	SUNSHINE	6901601000	227
ARROW	6910601335	199	FACCIA	5192801118	97	MERIDIAN	5616302118	65	SUNSHINE	7625701345	277
BATI	5188601125	93	FACE	5033001001	85	MERIDIAN	5616304118	65	SUNSHINE	7625601345	277
BATI	5188602125	93	FACE	5033002001	85	MERIDIAN	7216412118	67	SUNSHINE	6925601345	225
BATI	7188601125	95	FARELL	5194801001	265	MIMO	5194901053	251	TABLE CUBE	6908003331	189
BERLIN	7700511012	303	FARELL	5194802001	265	MIMO	5194901118	251	TABLE CUBE	6908001337	189
BONN	6330402001	149	FARELL	5194804001	31	MINI LEDSPOT	5614401118	53	TABLE CUBE	6908001331	189
BONN	6330401118	149	FLAIR	5288801012	167	MINI LEDSPOT	5614402118	53	TABLE CUBE	6908001339	189
BOX CUBE	5184601118	103	FLAIR	5288802012	167	MINI LEDSPOT	5614404118	53	TABLE CUBE	6908001340	189
BREAD	6901501000	203	FLAIR	5288803012	169	MINI LEDSPOT	7214603118	55	TABLE CUBE	6908002337	191
BRICK	6908501308	201	FLAIR	5288804012	169	MINI LEDSPOT	7214604118	55	TANGO	5192901118	91
BUBBLE	6908701001	205	FLAIR	7288801012	171	MINI LEDSPOT	6914401000	197	TELIN	5197002125	83
BULLO	6383001118	135	FLAIR	6588801012	171	MODO	7633301118	293	TILLY	6901201000	221
BULLO	6383001445	135	FOCUS	5604011118	129	ORIGO	6335142118	29	TITAN	6336201118	143
CATE	5264201213	177	FOCUS	5604010118	129	PADLIGHT	6907701331	193	TONA	5189601118	99
CATE	7264210213	177	FOCUS	6304201118	131	PADLIGHT	6907701339	193	TONA	5189602118	99
CATE	7264230213	177	FOCUS	7204803118	131	PADLIGHT	6907701340	193	TORUS	9701501330	285
CITY	5183601118	105	FOCUS	5605013118	133	PANO	5289001118	61	TRUMPET	5626101125	57
CRUZ	5199201118	81	FOCUS	5605103118	133	PANO	7289001118	61	TRUMPET	5626001118	57
CRUZ	7199201118	81	GEMINI	5189111118	33	PATH	5605701112	127	TRUMPET	5626002118	57
CRYSTAL	5521201001	123	GEMINI	5189114118	119	PATH	5605702112	127	TWILL	6908901335	207
CRYSTAL	5521601001	123	GEMINI	5189102118	115	PERI	7629502335	239	UBLO	6348102112	139
CUBA	5193801118	43	GEMINI	5189113118	115	PERI	7629501331	275	UBLO	6350102112	139
CUBA	7193801118	43	GEMINI	5189102032	115	PERI	7629401331	273	UBLO	6348101112	141
CUBA	5193803118	45	GEMINI	5189103118	115	PERI	7629301341	295	UBLO	6350101112	141
CUBA	7193802118	45	GEMINI	5189101118	117	PERI	7629001341	297	UNITE	5260201012	159
CURTIS	6934601118	211	GEMINI	5189112118	117	PERI	7629002426	297	UNITE	5260201030	159
CYDOPS	7704212012	307	GEMINI	5189104118	119	PILO	5186902118	111	UNITE	5260101012	159
CYRA	5198104118	51	GHOST	5188003118	69	POLE	9700308112	219	UNITE	5260101030	159
CYRA	7198101118	49	GHOST SOLAR	6901401337	215	POLLUX	5196001118	253	UNITE	5260103012	159
CYRA	5198101118	49	HELENA	6402101118	147	POPPY	6910802335	187	UNITE	5260103030	159
CYRA	5198102118	49	HELENA	5191601118	147	QUBO	5193003118	25	UNITE	7260401012	161
CYRA	5198102118	271	HELENA	5191602118	147	QUBO	7193002118	25	UNITE	7260401030	161
DAKOTA	5288601118	23	HILL	5195801001	113	QUBO	5195401118	77	UNITE	7260311012	161
DAKOTA	7288601118	23	KELSEY	5273701012	173	QUBO	5193001118	79	UNITE	7260311030	161
DAKOTA	7288602118	23	KELSEY	5273601012	173	QUBO	5193002118	79	URBAN	5196501118	107
DARLI	5274601412	179	KELSEY	7273602012	175	QUBO	7193001118	79	UTIN	7629701341	291
DENVER	7704801012	309	KELSEY	7273601012	175	QUBO	5193002118	267	VESTA	5190601118	243
DISO	6906702335	209	KIRA	5288901118	21	ROLA	6382201118	137	WHISPER	5198701001	71
DISO	6906703335	209	KIRA	7288901118	21	SECO	5189901118	87	ZERTA	5189501118	101
DRACO	7622206012	255	LEDA	5267103001	269	SEINE	6338201118	145	ZETA	6901101000	217
DRAGONFLY	6904101339	195	LEO	5192701118	125	SHRIMP	7621902012	281	ZOE	5240101012	157
DRAGONFLY	6904101337	195	LEO	5192701335	125						

