

2017

LED GO!

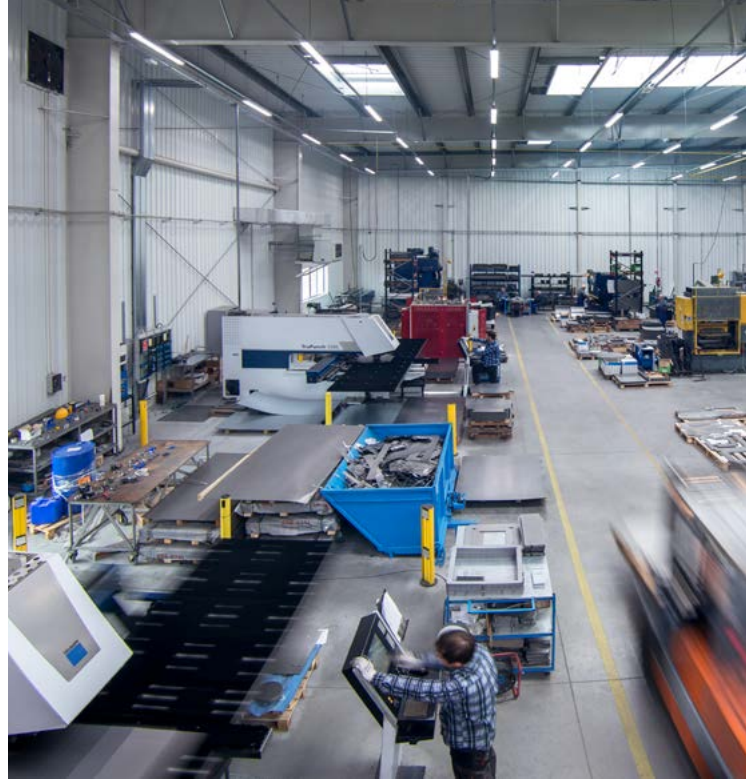



Lena Lighting – Polish lighting manufacturer

We are the company with the 100% Polish capital. For the past 27 years we have been one of the leading entities of the lighting market in Poland. Since 2005 the company has been listed on the Warsaw Stock Exchange and our good results distinguish us from other companies. Having developed our export capabilities to cover 70 countries in the world, we are now the unquestionable leader among Polish exporters of professional investment lighting.

New technologies

Lena Lighting R&D department deals with construction and design of new products, making use of state-of-the-art global solutions in LED technology and technical solutions in the field of lighting control. We offer a comprehensive range of architectural, industrial and road lighting, as well as a wide array of workplace and toolbox lighting.

An important feature of our products are the Led Go! light sources, characterized by very high parameters, integrated with the fittings.



Quality guarantee

The Led Go! light sources are covered by a warranty of up to 5 years*. At every stage of investment the customers of Lena Lighting are offered advice from our experts. We offer our help with the choice of products and lighting ideas. We provide visualizations and ready-made lighting system designs.

*detailed terms and conditions of warranty are available at www.lenalighting.pl



Ulbricht Sphere

A specialized device, with a shape and internal surface coating that ensure total reflection of light energy generated by a measured source and focused onto a measuring sensor. This allows for precise measurement of, e.g.: luminous flux, colour temperature (CCT), light spectrum or colour rendering index Ra (CRI).



Goniophotometer

A specialized device that measures the spatial distribution of light visible to the human eye at a specific angular position.

Tried and tested parameters

Lena Lighting laboratories are equipped with, e.g. goniophotometer, three spectrometers with integrated spheres (so called Ulbricht Spheres) and many other devices, that allow us to carry out reliable electrical and mechanical tests.

We can provide reliable data confirming the parameters of our products!

Energy-saving

We offer more illumination with significantly lower power requirements compared to traditional light sources.

Our products allow you to cut down on power use by up to 80%*.

Durability

The lifespan of LED GO! diodes is at least 50,000 hours, which means that for the next 17 years * our customers will not have to incur any maintenance costs for their lighting systems.

Functionality and safety

Thanks to the durability and reliability of LED fittings you not only eliminate maintenance costs but also have the freedom to install lighting in hard-to-reach places.



Synergy with nature

The highest possible energy efficiency results in the lowest possible use of power and reduced emissions of harmful greenhouse gases.

LED GO! light sources are free of mercury; they are safe for the users and easy to recycle.



* detailed calculations are available at www.lenalighting.pl

** selected fittings only

LED GO!

Modular construction of the fittings – savings guaranteed!

Assuming LED diodes' long lifespan, a lot of LED fittings' providers offer their luminaires at accordingly high prices, made as a closed construction with no possibility of repairing or servicing. In fact, it means that a client buying such expensive fittings accepts the situation when the savings connected with the new investment give the money return of its cost in a dozen or more years. What is more, in case of emergency the whole fittings will have to be replaced.

Guaranteed savings

LED GO! fittings are under a three-year guarantee and they are offered at the prices which enable money return from the investment even within 6 months. It means that thanks to buying such fittings the client is in a comfortable situation, because the effect of savings connected with the new investment returns the cost of it even after 2 years. In case of emergency, in turn, the fittings are still under guarantee.

The advantages of modular construction

In addition, the modular construction of the latest LED GO! fittings enables safe replacement of an electrical module which contains LED panel, adapter and a power supply terminal block. Thanks to it, after the guarantee period, the client can cheaply modernize the fittings on his own. There is no need to replace the whole fittings or change the electrical installation. We guarantee the availability (for sale) of electrical modules made in present LED technology for typical LED fittings.

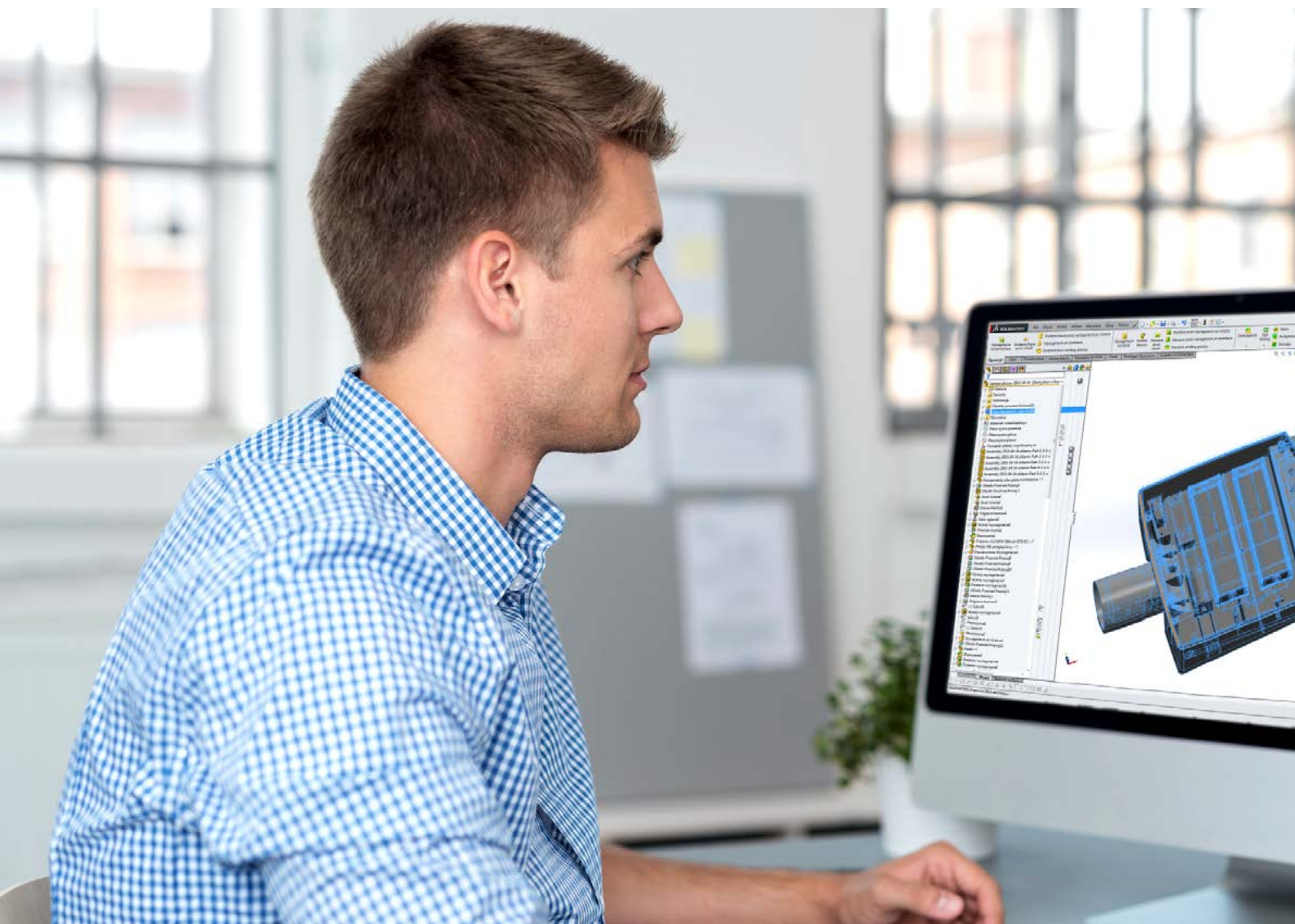



LED GO! light sources used in the fittings made by Lena Lighting have the luminous flux up to 150 lm/W. The LED sources selection enables uniform and regular colour temperature of 3000K (warm colour) and 4000K (neutral colour).

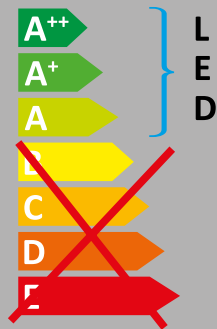

LED GO! panels' energy saving

Energy label allows to choose the least energy consuming products (power measured in watts [W]) compared to the obtained amount of light (luminous flux of the fitting, measured in lumens [lm]).

LED GO! panels offer more light with much lower energy consumption compared to the traditional sources.

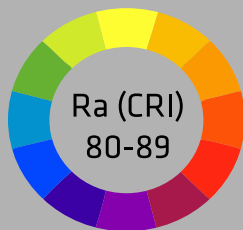

A high rate of colour rendering index Ra

Thanks to the latest LED technology, a high rate of colour rendering index Ra (CRI) 80-89. CRI>90 available on request.

Spectrum light distribution

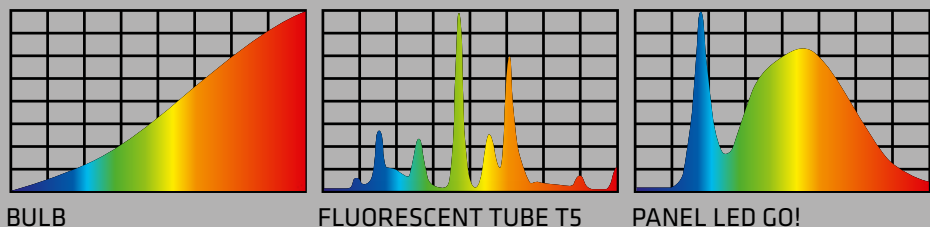

Compared to popular fluorescent fittings, the spectrum light distribution produced by LED GO! panels ensures better comfort for work requiring eyesight focus. Within a visible range, it is still similar to traditional bulbs. LED GO! panels' spectrum does not contain infrared or UV radiation.

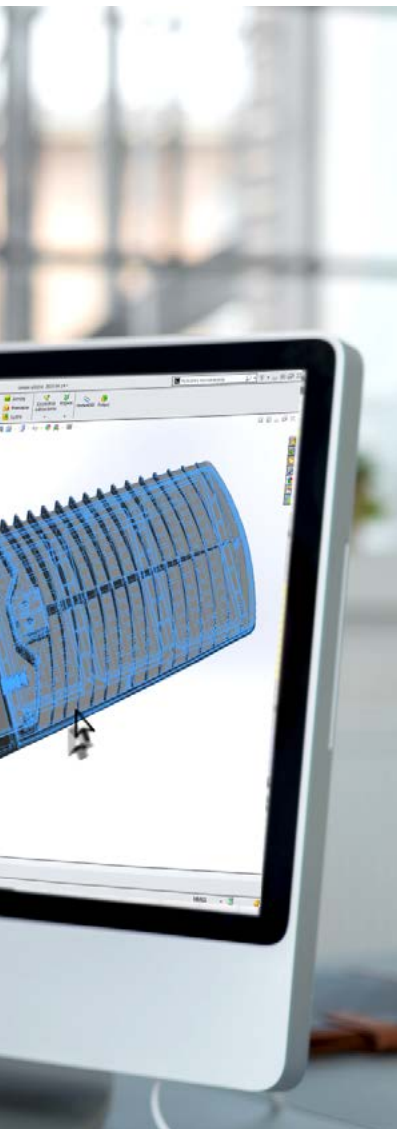

LED Lighting for your investment

In complex way

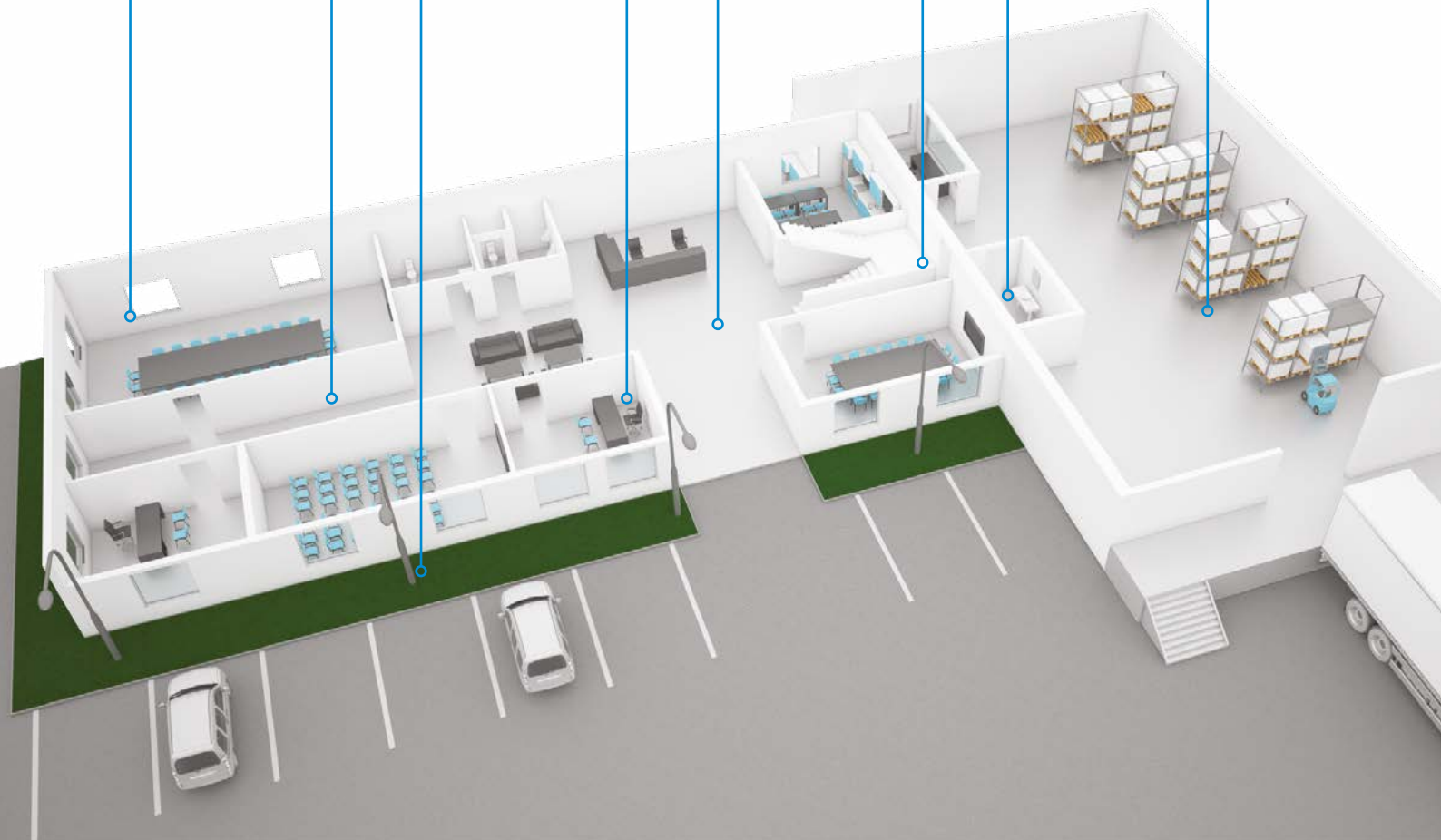

OFFICE
LIGHTING

13

INDUSTRIAL
LIGHTING &
FLOODLIGHTS

107

BULKHEADS

171

STREET
LIGHTING

227

EMERGENCY
LIGHTING

245

ACCENT
LIGHTING

257

LIGHTING
CONTROL

273



OFFICE LIGHTING



MODULUS LED
14



SENAR LED
20



SENAR II LED
22

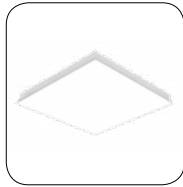

COMPACT LED
24



SOLARIS LED
28



KASTOR LED
30



MADERA II LED
32



MADERA LED
36



MADERA ALTUS LED
38

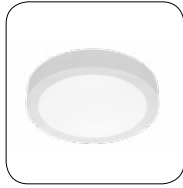

CORIA LED
40



PLANO II LED
42

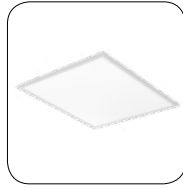

PLANO LED
48



SMART LED
50



INTEGRA LED
54



INTEGRA LED WALL LIGHTS
58



DECO LINE LED
60



CLEO II LED
64



TERRA LED
66



INDO LED
68



INDO PLX LED
70



LABO LED
72



PURO LED
76



SWING LED
78



DL 220 LED
82



NECTRA ART LED
86



FRAGA LED
88



NECTRA LED
92



NECTRA LED IP44
96



DL 155/185 LED
100



DLN 220 LED
102



NECTRA S LED
104

INDUSTRIAL LIGHTING & FLOODLIGHTS



CODAR RS LED EVO
108



CODAR RS PREVALED
116



CODAR RS LED EVO
ENDURA
118



CODAR RS LED EVO HALL
120



TUBE LED EVO
122

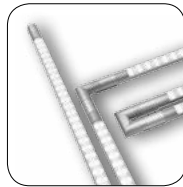

TUBE LED SYSTEM EVO
126



CONNECT LED
130

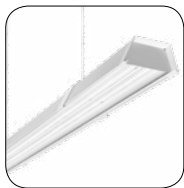

LINEA LED
134



INDUSTRY LED
138



VECTOR LED
142



VECTOR II LED
144

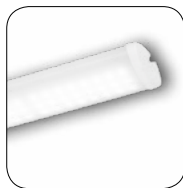

FORTAN LED
146



FORTAN LED SYSTEM
148



SPECTO LED
152



RAX LED
154



FACTOR LED Z
156



FACTOR LED N
158



FACTORIA LED
160



QUEST LED
164



VIGO LED
166



VIGO R LED
168

BULKHEADS

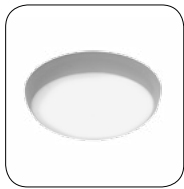

PROXIMA LED
172



PHOBOS LED
178



CALLISTO LED
180



GLO LED
182



TEO LED
184



SATURN LED
186



MERCURY LED
190



CAMEA LED EVO
192



CAMEA LED
194



CAMEA PRO LED EVO
198



ORBIT LED
200



DISC LED
202



IZAR LED
204



CORAL LED
206



SQUARE LED
210



QUADRO LED
212



PORTAL LED
214



POINT LED
216



OVAL PRO LED
218



OVAL LUX LED
220



OVAL LED
222

STREET LIGHTING



CORONA LED
230



CORONA ROAD LED
238



CORONA LITE LED
242

EMERGENCY LIGHTING

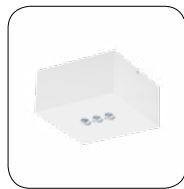

DOT LED
246



LUMAX S LED
252



POXAR SNF LED
254

ACCENT LIGHTING



MODO LED
258



MODO MINI LED
260



PILLAR LED
262



PILLAR MINI LED
264



UP LED
266



MINI LED
268

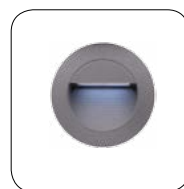

BILEO LED
270





OFFICE LIGHTING



MODULUS LED

A recessed LED modular luminaire with an optics providing perfect lighting performance for offices and retail spaces.



LED MATRIX SYSTEM

Construction with LED installed at the back of luminaire with the flux directed down in order to achieve maximum efficiency, high light flux and effectivity.

MULTIPLE APPLICATION

Recessed mounting in modular or plasterboard ceiling in 600x600 and 625x625 standard.

NEW OR MODERNISATION

It is appropriate for new applications as well as replacing conventional T8 & T5 fittings with energy-saving LED solutions.

CASE STUDY

SAVE 44% OF ENERGY THANKS TO MODULUS LED

While enlarging a workshop, Investor also decided to enlarge the head office. Because of the additional, unexpected earlier cost of the work, we were told to audit the lighting and to find the most cost-effective option.

Taking under consideration the fact, that the investor cared about the most economical solution, we compared two options of lighting the office space and the neighbouring utility rooms. In the first option (traditional lighting with highly efficient fluorescent luminaires), the list of materials contained 5 positions with the total amount of 75 fittings. In the second option (only LED lighting), the list had only 4 positions for 61 fittings. According to the directives, both of the options ensured the optimum light intensity (brightness) on the rooms' floor.

The picture below shows parameters and layout of the office rooms together with adjacent routes and social rooms.

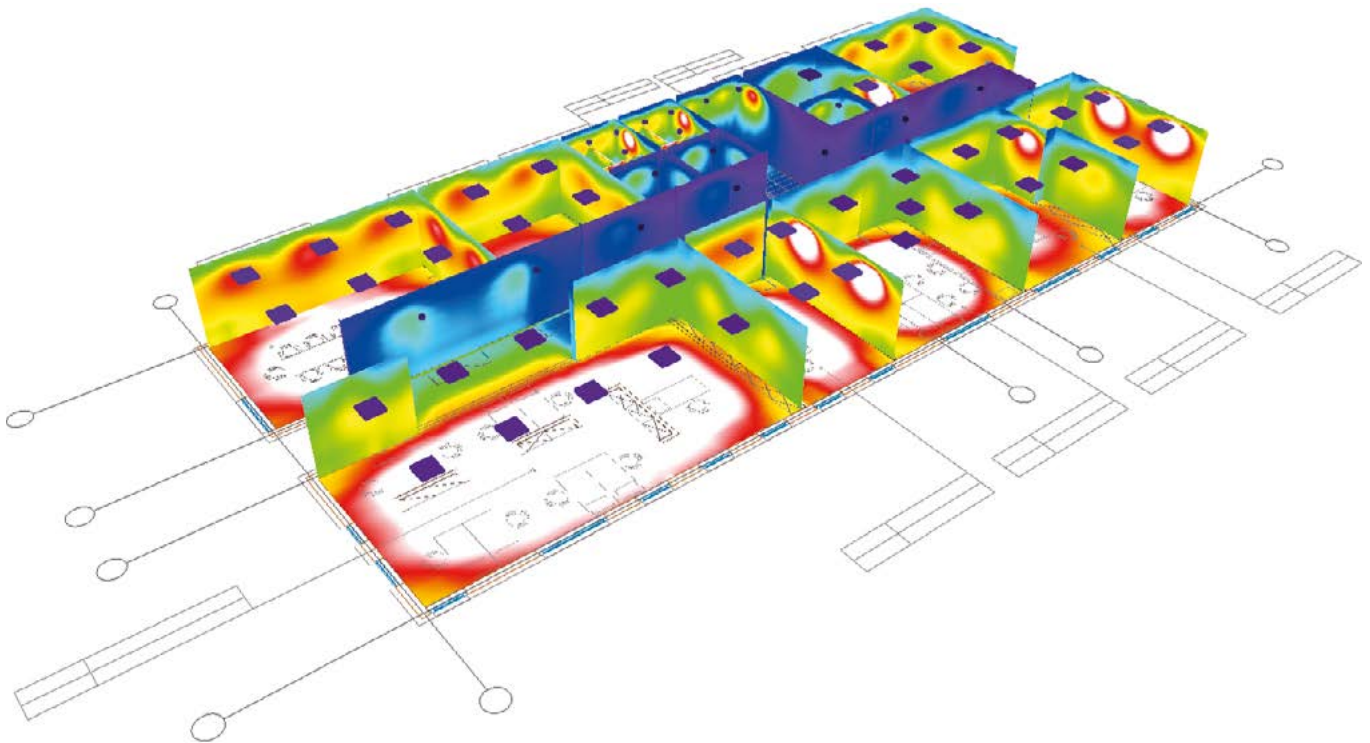

VARIANT A - EVG

- 10 x downlight 2x18W EVG,
- 03 x downlight 2x26W EVG
- 12 x downlight IP44 2x26W EVG
- 47 x PAR - 4x18W EVG
- 03 x PLX - 4x18W EVG

75 fittings

VARIANT B - LED

- 11x DL 185 LED 14W 4000K
- 7x DL 185 LED 21W 4000K
- 28x MODULUS LED 48W PLX 4000K
- 15x MODULUS LED 48W PRM 4000K

61 fittings

Just the first comparison of both of the options showed how much more profitable the solution with LED lighting was. From the Investor's point of view, LED lighting option was more uniform and did not generate the costs connected with required cyclical maintenance work.

According to the Investor's experience, traditional lighting (fluorescent luminaires) required buying lots of light sources and regular replacement of the sources, which caused diversity of fittings on the ceiling (not very aesthetic).

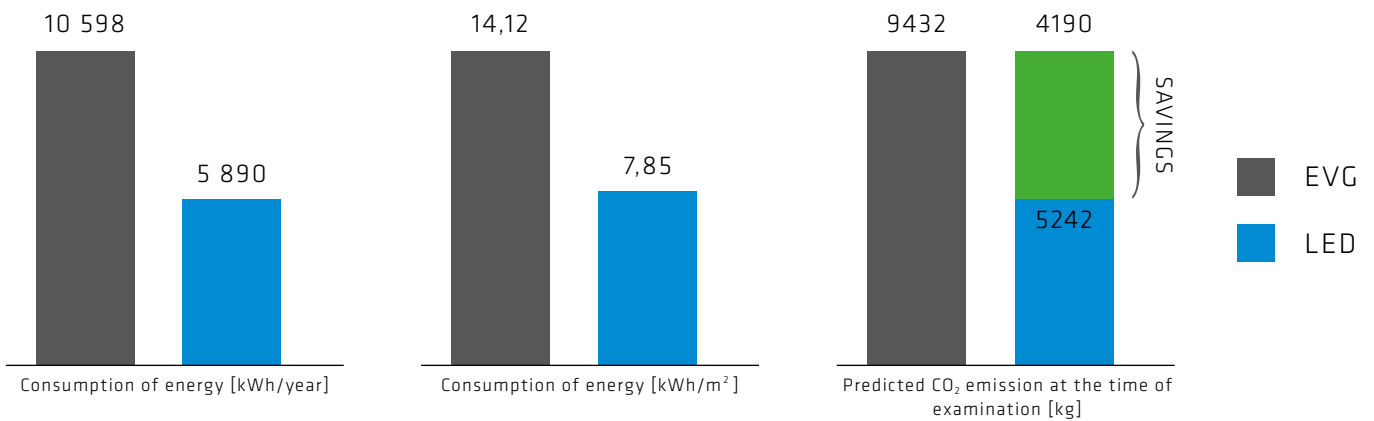

AMORTISATION OF COSTS

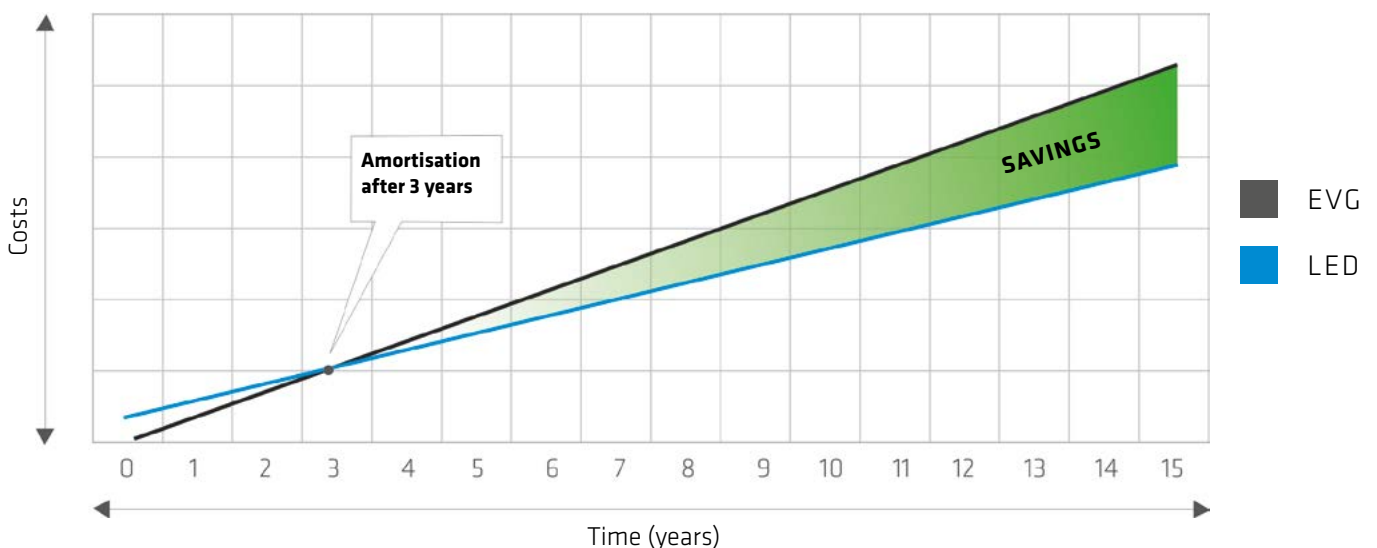

The comparative analysis showed a lot of benefits from using LED fittings. First of all, the estimation proved that the total energy consumption per 1m² is 44% lower for LED fittings than in the case of traditional fluorescent luminaires. The effect was reached not only thanks to the lower energy consumption by LED fittings but also because of installing lower amount of fittings themselves.

In addition, what was particularly important for the Investor, lower amount of fittings decreased the costs of installation and work connected with that unplanned investment, and decrease of the estimated CO₂ emission was an important support for long-lasting marketing actions.

Considering all the costs of buying and installation, the estimated time for money return from the investment was scheduled to the third year. After this time the Investor will experience constant, dynamic profits' increase thanks to using LED fittings (green colour in the chart of savings). Despite the necessity of higher costs, the Investor accepted the argument for future benefits and decided to choose the option with LED lighting.



THE BASIC ASSUMPTION OF CASE STUDY:

Price for 1 kWh - 0,12 EUR; the cost of replacing the light sources on the basis of average market prices according to the knowledge of Lena Lighting S.A.; fluorescent fittings with electronic ballasts.

MODULUS LED

OFFICE LIGHTING

LED GO!



SPECIFICATION

Ingress protection class:	IP40	Recessed mounted LED luminaire with a high total luminous flux for modular or plasterboard ceiling systems. Made from powder coated white steel sheet and a highly uniform low glare opal/prismatic diffuser. Equipped with energy saving light sources LED GO! Colour temperature, 3000K/4000K CRI>80, lifespan of LED 50 000h (L70B50) $t_a = 25^\circ\text{C}$.
Total luminous flux:*	max. 4750lm (4000K)	
Colour temperature (CCT):	3000K, 4000K	
Energy efficiency class (EEI):	A	
Power supply:	220-240V / 50-60Hz	
Mounting:	recessed in modular ceiling recessed in plasterboard ceiling (mounting kit included)	
Body:	powder coated steel	
Diffuser:	PMMA OPAL, PRM	

LIGHT BEAM CURVES

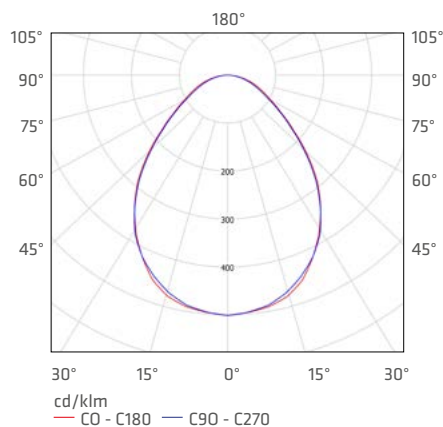

APPLICATION

Recessed luminaire for indoor application in offices or general use. Suitable for task lighting even when eyesight concentration is required. As well as new installations, it is an ideal energy saving replacement solution for conventional T8 & T5 luminaires. Modular ceiling mounted (600x600 and 625x625). Available version for plasterboard ceiling (KG).

MODULUS LED

OFFICE LIGHTING

MODULUS LED 600



IP40

MODULE CEILING
600/600

5,20

rated power [W]	colour temperature [K]	total luminous flux* [lm]	diffuser	EEI	index
48	3000	4350	PRM	A	019517
48	4000	4750	PRM	A	019579
48	3000	4100	OPAL	A	019500
48	4000	4500	OPAL	A	019562

MODULUS LED 1200



IP40

MODULE CEILING
1200/300

4,70

rated power [W]	colour temperature [K]	total luminous flux* [lm]	diffuser	EEI	index
48	3000	4350	PRM	A	019340
48	4000	4750	PRM	A	019357
48	3000	4100	OPAL	A	019326
48	4000	4500	OPAL	A	019333

MODULUS LED 625



IP40

MODULE CEILING
625/625

5,40

rated power [W]	colour temperature [K]	total luminous flux* [lm]	diffuser	EEI	index
48	3000	4350	PRM	A	019555
48	4000	4750	PRM	A	019616
48	3000	4100	OPAL	A	019548
48	4000	4500	OPAL	A	019609

PLASTERBOARD MOUNTED:

MODULUS LED 600 KG



IP40

600/600

5,20

rated power [W]	colour temperature [K]	total luminous flux* [lm]	diffuser	EEI	index
48	3000	4350	PRM	A	019531
48	4000	4750	PRM	A	019593
48	3000	4100	OPAL	A	019524
48	4000	4500	OPAL	A	019586

MODULUS LED 1200 KG



IP40

1200/300

4,70

rated power [W]	colour temperature [K]	total luminous flux* [lm]	diffuser	EEI	index
48	3000	4350	PRM	A	019043
48	4000	4750	PRM	A	019319
48	3000	4100	OPAL	A	019302
48	4000	4500	OPAL	A	019036

*Initial, tolerance +/- 10%



SPECIFICATION

Ingress protection class:	IP40
Total luminous flux:*	max. 3850lm (4000K)
Colour temperature (CCT):	3000K, 4000K
Energy efficiency class (EEI):	A
Power supply:	220-240V / 50-60Hz
Mounting:	recessed in modular ceiling
Body:	powder coated steel
Diffuser:	PMMA OPAL, PRM

Recessed mounted square LED luminaire with a high total luminous flux for modular or plasterboard ceiling systems. Made from powder coated white steel sheet and a highly uniform low glare opal/prismatic diffuser. Equipped with energy saving light sources LED GO! Electrical connection possible without opening the fitting. Colour temperature, 3000K/4000K CRI>80, lifespan of LED 50 000h (L70B50) $t_a = 25^\circ\text{C}$.

LIGHT BEAM CURVES

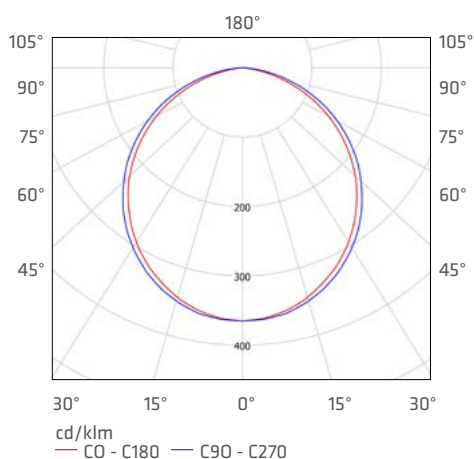

APPLICATION

Recessed luminaire for indoor application in offices or general use. Suitable for task lighting even when eyesight concentration is required. As well as new installations, it is an ideal energy saving replacement solution for conventional T8 & T5 luminaires. Modular ceiling mounted (600x600).

SENAR LED

OFFICE LIGHTING

SENAR LED



IP40 |

rated power [W]	colour temperature [K]	total luminous flux* [lm]	diffuser	EEl	index
32	3000	2700	OPAL	A	902017
32	4000	2900	OPAL	A	902000
32	3000	2800	PRM	A	902253
32	4000	3000	PRM	A	902246
40	3000	3450	OPAL	A	902031
40	4000	3750	OPAL	A	902024
40	3000	3550	PRM	A	902079
40	4000	3850	PRM	A	902062

MODULE CEILING
600/600

2,96 KG

* Initial, tolerance +/- 10%



SENAR II LED

OFFICE LIGHTING

LED GO!



SPECIFICATION

Ingress protection class:	IP40	Recessed mounted square LED luminaire for modular ceiling system with high total luminous flux, made from powder coated white steel sheet, equipped with energy saving light sources LED GO! Highly uniform opal diffuser, which enables low glare, electrical connection possible without opening the fitting. Features: colour temperature 4000K, CRI>80, lifespan of LED 50 000h (L70B50) $t_a = 25^\circ\text{C}$.
Total luminous flux*:	max. 3700lm (4000K)	
Colour temperature (CCT):	4000K	
Energy efficiency class (EEI):	A	
Power supply:	220-240V / 50-60Hz	
Mounting:	recessed in modular ceiling	
Body:	powder coated steel	
Diffuser:	PMMA OPAL	

LIGHT BEAM CURVES

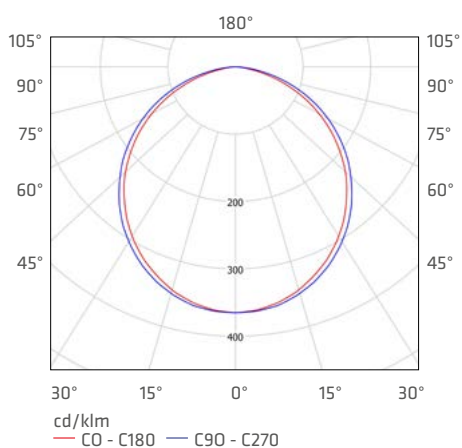

APPLICATION

Recessed luminaire for indoor application in offices or general use. Appropriate as the main light source even when the work requires eyesight concentration. Well suited for new applications as well as replacing conventional T8 & T5 with energy-saving solutions. Construction adapted for installation in modular ceilings.

SENAR II LED

OFFICE LIGHTING

SENAR II LED



IP40 | 

rated power [W]	colour temperature [K]	total luminous flux* [lm]	diffuser	EEL	index
32	3000	2700	OPAL	A	902284
32	4000	2700	OPAL	A	902260
40	3000	3200	OPAL	A	902338
40	4000	3200	OPAL	A	902277

MODULE CEILING
600/600

3,40  KG

* Initial, tolerance +/- 10%



COMPACT LED

OFFICE LIGHTING

LED GO!



SPECIFICATION

Ingress protection class:	IP44/IP40
Total luminous flux:*	max. 5700lm (4000K)
Colour temperature (CCT):	3000K, 4000K
Energy efficiency class (EEI):	A+
Power supply:	220-240V / 50-60Hz
Mounting:	surface / recessed in modular ceiling
Body:	ABS
Diffuser:	PMMA OPAL / PRM

New Compact LED luminaire designed for installation in modular ceilings or surface mounting. Equipped with energy saving light sources LED GO! and a highly uniform low glare opal diffuser. Assembly & electrical connection possible without opening the fitting.

LIGHT BEAM CURVES

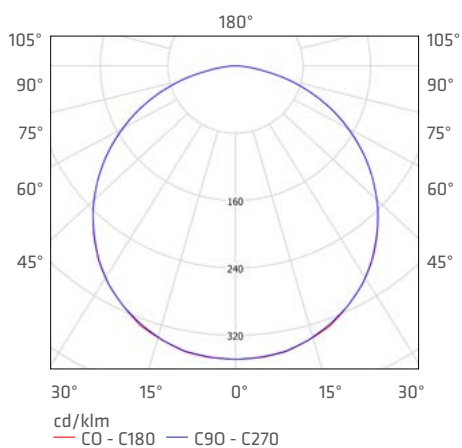

APPLICATION

Luminaire for indoor application in offices or general use. Suitable for task lighting even when eyesight concentration is required. As well as new installations, it is an ideal energy saving replacement solution for conventional T8 & T5 luminaires. Modular ceiling mounted (600x600).

SURFACE MOUNTING:

COMPACT LED N 32W

IP40 

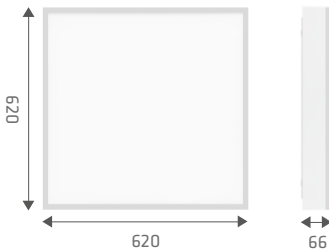

2,30  KG

rated power [W]	colour temperature [K]	total luminous flux* [lm]	diffuser	EEl	index
32	3000	3350	OPAL	A+	904264
32	4000	3600	OPAL	A+	904257

COMPACT LED N 36W

IP40 

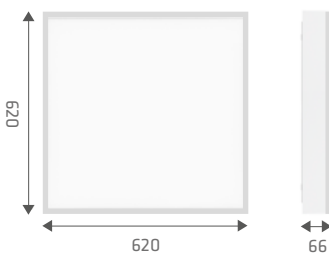

2,30  KG

rated power [W]	colour temperature [K]	total luminous flux* [lm]	diffuser	EEl	index
36	3000	3650	OPAL	A+	904240
36	4000	3950	OPAL	A+	904233

COMPACT LED N 50W

IP40 

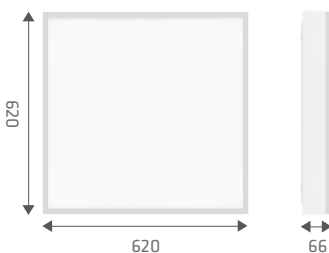

2,30  KG

rated power [W]	colour temperature [K]	total luminous flux* [lm]	diffuser	EEl	index
50	3000K	4850	OPAL	A+	904226
50	4000K	5300	OPAL	A+	904219

* Initial, tolerance +/- 10%

Available options: **DALI** (for 36W, 50W)

COMPACT LED

OFFICE LIGHTING

RECESSED MOUNTING:

COMPACT LED P 32W

IP44 



MODULE CEILING
600/600
1,90 

rated power [W]	colour temperature [K]	total luminous flux* [lm]	diffuser	EEI	index
32	3000	3350	OPAL	A+	904004
32	4000	3600	OPAL	A+	904011
32	3000	3650	PRM	A+	904028
32	4000	3950	PRM	A+	904035

COMPACT LED P 36W

IP44 



MODULE CEILING
600/600
1,90 

rated power [W]	colour temperature [K]	total luminous flux* [lm]	diffuser	EEI	index
36	3000	3650	OPAL	A+	904066
36	4000	3950	OPAL	A+	904073
36	3000	3950	PRM	A+	904042
36	4000	4300	PRM	A+	904059

COMPACT LED P 50W

IP44 



MODULE CEILING
600/600
1,90 

rated power [W]	colour temperature [K]	total luminous flux* [lm]	diffuser	EEI	index
50	3000	4850	OPAL	A+	904103
50	4000	5300	OPAL	A+	904110
50	3000	5250	PRM	A+	904080
50	4000	5700	PRM	A+	904097

* Initial, tolerance +/- 10%

Available options: **DALI** (for 36W, 50W)

TECHNICAL DETAILS

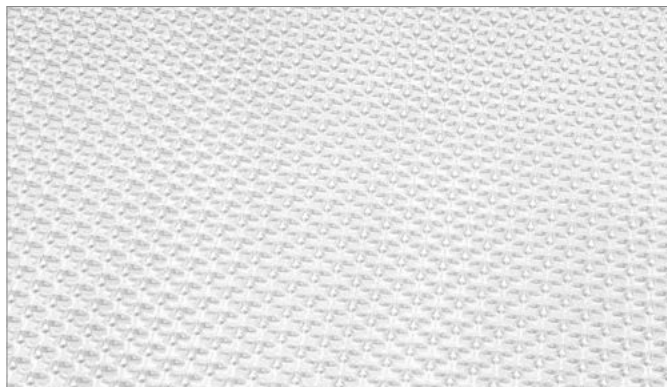

PRM diffuser

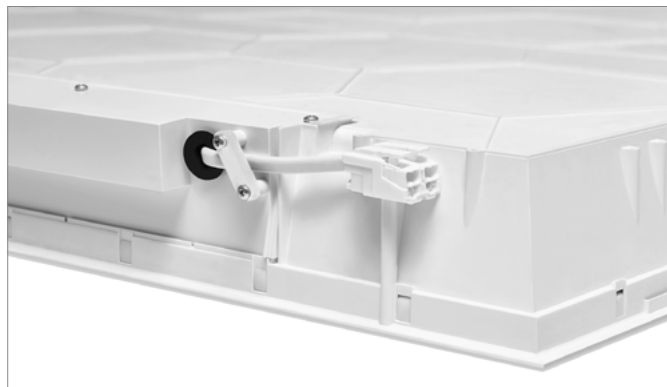

Power connector

ACCESSORIES

index	article name
904349	Mounting securing assembly (for module ceiling)

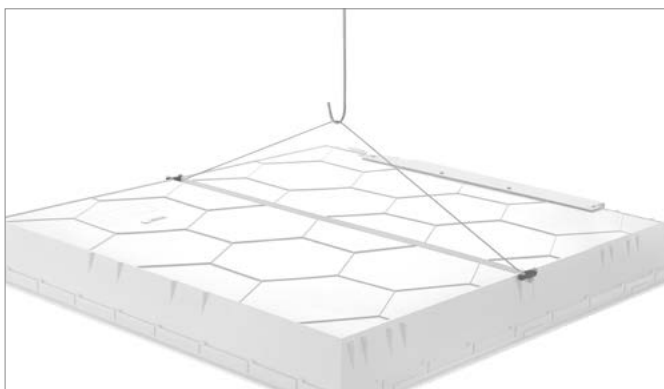

Mounting securing assembly (for module ceiling)



SOLARIS LED

OFFICE LIGHTING

LED GO!



SPECIFICATION

Ingress protection class:	IP40	Surface mounted LED luminaire with a high total luminous flux, made of powder coated white or silver (RAL 9006) steel sheet, equipped with energy saving light sources LED GO! and a highly uniform low glare opal/prismatic diffuser. Colour temperature 3000/4000K, CRI>80, lifespan of LED 50 000h (L70B50) $t_a= 25^{\circ}\text{C}$.
Total luminous flux:*	max. 4550lm (4000K)	
Colour temperature (CCT):	3000K, 4000K	
Energy efficiency class (EEI):	A	
Power supply:	220-240V / 50-60Hz	
Mounting:	surface	
Body:	powder coated steel	
Diffuser:	PMMA OPAL / PRM	

LIGHT BEAM CURVES

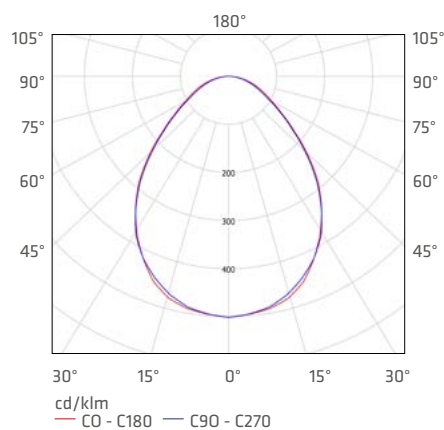

APPLICATION

General purpose surface mounted luminaire for indoor application in offices or other utility rooms. Appropriate as the main light source even when eyesight concentration is required

SOLARIS LED 660

IP40 

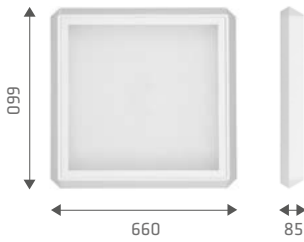

5,35  KG

rated power [W]	colour temperature [K]	total luminous flux* [lm]	diffuser	EEl	index
48	3000	4100	OPAL	A	009204
48	4000	4550	OPAL	A	009228
48	3000	4550	PRM	A	009235
48	4000	5000	PRM	A	009242
48	4000	4550	OPAL	A	009396
48	4000	5000	PRM	A	009402

SOLARIS LED 660 SILVER

IP40 

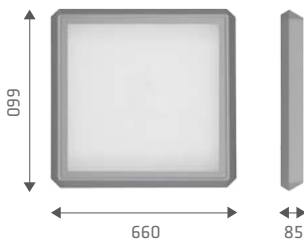

5,35  KG

rated power [W]	colour temperature [K]	total luminous flux* [lm]	diffuser	EEl	index
48	4000	4550	OPAL	A	009396
48	4000	5000	PRM	A	009402

SOLARIS LED 1250

IP40 



5,57  KG

rated power [W]	colour temperature [K]	total luminous flux* [lm]	diffuser	EEl	index
48	4000	4550	OPAL	A	009372
48	4000	5000	PRM	A	009341

SOLARIS LED 1250 SILVER

IP40 



5,57  KG

rated power [W]	colour temperature [K]	total luminous flux* [lm]	diffuser	EEl	index
48	4000	4550	OPAL	A	009419
48	4000	5000	PRM	A	009426

* Initial, tolerance +/- 10%

KASTOR LED

OFFICE LIGHTING

LED GO!



SPECIFICATION

Ingress protection class:	IP40
Total luminous flux:*	max. 4000lm (4000K)
Colour temperature (CCT):	3000K, 4000K
Energy efficiency class (EEI):	A
Power supply:	220-240V / 50-60Hz
Mounting:	surface
Body:	powder coated steel
Diffuser:	PMMA OPAL

Surface mounted LED luminaire with a high total luminous flux. Made from powder coated white or silver (RAL 9006) steel sheet and a highly uniform low glare opal/prismatic diffuser. Equipped with energy saving light sources LED GO!. Electrical connection possible without opening the fitting. Colour temperatures: 3000K/4000K, CRI > 80, lifespan of LED 50 000h (L70B50) $t_a = 25^\circ\text{C}$.

LIGHT BEAM CURVES

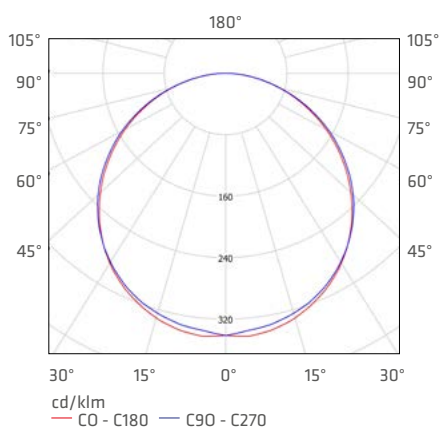

APPLICATION

Versatile luminaire designed for internal use in offices and utility rooms. As well as new installations, it is an ideal energy saving replacement solution for conventional T8 & T5 luminaires.

KASTOR LED WHITE

IP40 | 

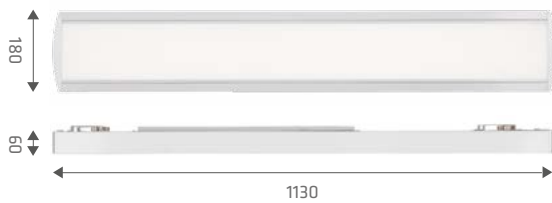

3,6  KG

rated power [W]	colour temperature [K]	total luminous flux* [lm]	diffuser	EEL	index
48	3000	3700	OPAL	A	040979
48	4000	4000	OPAL	A	040962

KASTOR LED SILVER

IP40 | 



3,6  KG

rated power [W]	colour temperature [K]	total luminous flux* [lm]	diffuser	EEL	index
48	3000	3700	OPAL	A	040795
48	4000	4000	OPAL	A	040788

* Initial, tolerance +/- 10%

TECHNICAL DETAILS



New, esthetic finishing element



Quick and stable mounting system

MADERA II LED

OFFICE LIGHTING

LED GO!



SPECIFICATION

Ingress protection class:	IP44	Surface mounted, square LED luminaire with a high luminous flux and improved IP. Made of powder coated grey steel (RAL 9006) sheet and a highly uniform low glare opal diffuser. Equipped with energy saving light sources LED GO!. It is a decorative fitting available in three sizes; optional equipment: radio motion sensor (RCR). Colour temperature 3000K/4000K, CRI>80, lifespan of LED 50 000h (L70B50) $t_a=25^{\circ}\text{C}$.
Total luminous flux*:	max. 3800lm (4000K)	
Colour temperature (CCT):	3000K, 4000K	
Energy efficiency class (EEI):	A	
Power supply:	220-240V / 50-60Hz	
Mounting:	surface	
Body:	powder coated steel	
Diffuser:	PMMA OPAL	

LIGHT BEAM CURVES

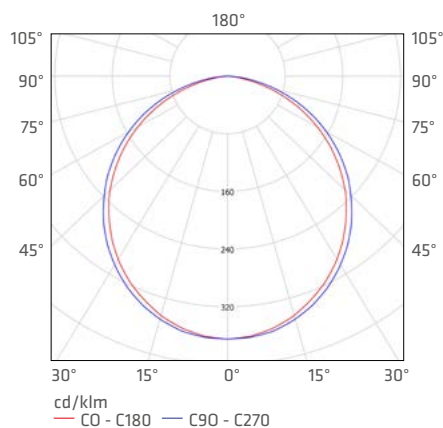

APPLICATION

Surface mounted luminaire intended for indoor use in offices or publicly accessible areas in public buildings, eg. receptions, corridors, staircases, toilets. Product designed for surface mounting either on ceilings or on walls. Luminaire housing protected against solid objects over 1mm and against streams of water flowing from any direction.

MADERA II LED

OFFICE LIGHTING

MADERA II LED 18W

IP44 | 

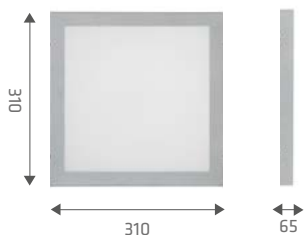

2,00  KG

rated power [W]	colour temperature [K]	total luminous flux* [lm]	diffuser	EEl	sensor	index
18	3000	1250	OPAL	A	-	472299
18	4000	1350	OPAL	A	-	472268
18	3000	1250	OPAL	A	RCR	472350
18	4000	1350	OPAL	A	RCR	472329

MADERA II LED 30W

IP44 | 

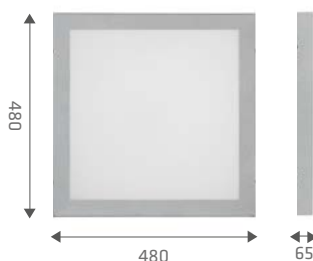

3,80  KG

rated power [W]	colour temperature [K]	total luminous flux* [lm]	diffuser	EEl	sensor	index
30	3000	2500	OPAL	A	-	472305
30	4000	2700	OPAL	A	-	472275
30	3000	2500	OPAL	A	RCR	472367
30	4000	2700	OPAL	A	RCR	472336

MADERA II LED 36W

IP44 | 

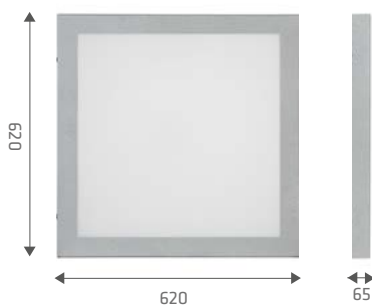

6,1  KG

rated power [W]	colour temperature [K]	total luminous flux* [lm]	diffuser	EEl	sensor	index
36	3000	2700	OPAL	A	-	472404
36	4000	2900	OPAL	A	-	472411
36	3000	2700	OPAL	A	RCR	472428
36	4000	2900	OPAL	A	RCR	472435

MADERA II LED 48W

IP44 | 



6,1  KG

rated power [W]	colour temperature [K]	total luminous flux* [lm]	diffuser	EEl	sensor	index
48	3000	3750	OPAL	A	-	472312
48	4000	4050	OPAL	A	-	472282
48	3000	3750	OPAL	A	RCR	472374
48	4000	4050	OPAL	A	RCR	472343

* Initial, tolerance +/- 10%

MADERA II LED

OFFICE LIGHTING

DUAL STREAM FITTINGS:

MADERA II LED 36W

IP44 



6,3  KG

rated power [W]	colour temperature [K]	total luminous flux* [lm]	diffuser	EEl	sensor	index
36	3000	2700	OPAL	A	RCR	472480
36	4000	2900	OPAL	A	RCR	472466

MADERA II LED 48W

IP44 

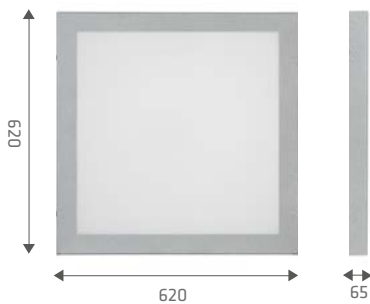

6,3  KG

rated power [W]	colour temperature [K]	total luminous flux* [lm]	diffuser	EEl	sensor	index
48	3000	3750	OPAL	A	RCR	472497
48	4000	4050	OPAL	A	RCR	472473

* Initial, tolerance +/- 10%



MADERA LED

OFFICE LIGHTING

LED GO!



SPECIFICATION

Ingress protection class:	IP20	<p>Surface mounted, square LED luminaire with a high luminous flux and improved IP. Made of powder coated grey steel (RAL 9006) sheet and a highly uniform low glare opal diffuser. Equipped with energy saving light sources LED GO!. It is a decorative fitting available in three sizes; optional equipment: radio motion sensor (RCR). Colour temperature 3000K/4000K, CRI>80, lifespan of LED 50 000h (L70B50) $t_a= 25^{\circ}\text{C}$.</p>
Total luminous flux*:	max. 3100lm (4000K)	
Colour temperature (CCT):	3000K, 4000K	
Energy efficiency class (EEI):	A	
Power supply:	220-240V / 50-60Hz	
Mounting:	surface	
Body:	powder coated steel	
Diffuser:	PMMA OPAL	

LIGHT BEAM CURVES

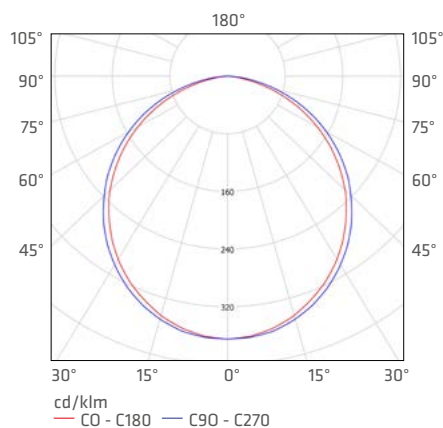

APPLICATION

Surface mounted luminaire intended for indoor use in offices or publicly accessible areas in public buildings, eg. receptions, corridors, staircases, toilets. Product designed for surface mounting either on ceilings or on walls. Luminaire housing protected against solid objects over 1mm and against streams of water flowing from any direction.

MADERA LED

OFFICE LIGHTING

MADERA LED IP20

IP20 

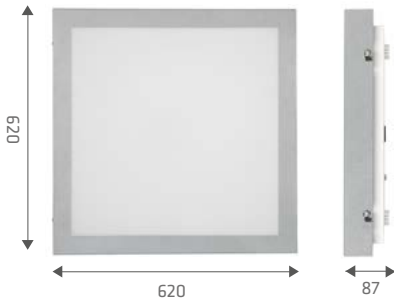

4,1  KG

rated power [W]	colour temperature [K]	total luminous flux* [lm]	diffuser	EEl	index
32	3000	2850	OPAL	A	472145
32	4000	3100	OPAL	A	472138

* Initial, tolerance +/- 10%



MADERA ALTUS LED

OFFICE LIGHTING

LED GO!



SPECIFICATION

Ingress protection class:	IP20	Suspended square LED fitting 900x900mm, equipped with energy-saving LED GO! panels, with high luminous flux. It's made of aluminium and powder coated steel. Available in three colors: black, grey and white. Opal diffuser enables even light distribution and minimizes the glare effect. Specification: color temperature 3000K, 4000K; CRI>80; LED panels lifespan 50 000 hours (L70B50) $t_a = 25^\circ\text{C}$.
Total luminous flux*:	max. 5050lm (4000K)	
Colour temperature (CCT):	3000K/4000K	
Energy efficiency class (EEI):	A+, A	
Power supply:	230V/50Hz	
Mounting:	suspended	
Body:	aluminium, powder coated steel	
Diffuser:	polimetakrylan (PMMA) OPAL	

LIGHT BEAM CURVES

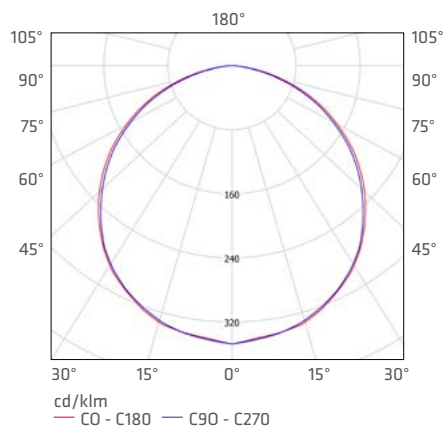

APPLICATION

Multi-function LED fitting dedicated for: representative buildings, railway station halls, waiting rooms, shopping malls, entrance zones in public buildings.

MADERA ALTUS LED

OFFICE LIGHTING

MADERA ALTUS LED

IP20 

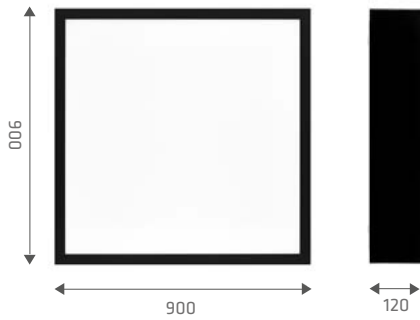

17,2  KG

rated power [W]	colour temperature [K]	total luminous flux* [lm]	diffuser	Colour	EEL	index
50	3000	4650	OPAL	BIAŁY	A	472077
50	4000	5050	OPAL	BIAŁY	A+	472084
50	3000	4650	OPAL	CZARNY	A	472091
50	4000	5050	OPAL	CZARNY	A+	472107
50	3000	4650	OPAL	SZARY	A	472114
50	4000	5050	OPAL	SZARY	A+	472121

* Initial, tolerance +/- 10%

CORIA LED

OFFICE LIGHTING

LED GO!

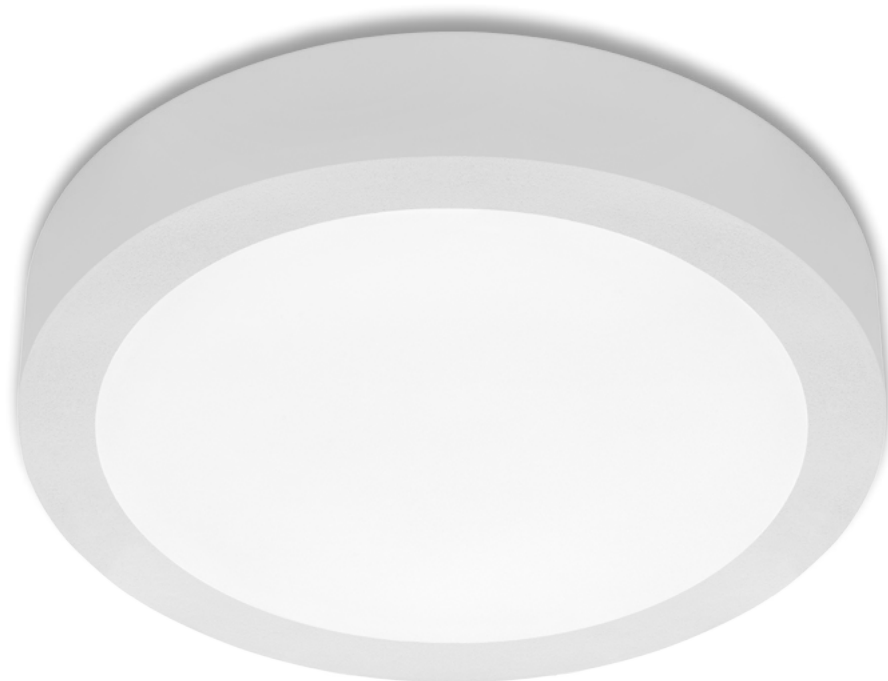

SPECIFICATION

Ingress protection class:	IP40
Total luminous flux:*	max. 3000lm (4000K)
Colour temperature (CCT):	3000K, 4000K
Energy efficiency class (EEI):	A+, A
Power supply:	230V/50Hz
Mounting:	surface / recessed
Body:	powder coated steel
Diffuser:	PMMA OPAL

Round LED luminaire with a big diameter and an integrated energy-saving light source guarantees high luminous flux and even light distribution. Its body is made of white powder coated steel, and the diffuser is made of opal PMMA. It works perfectly while designing new applications as well as replacing traditional luminaires with energy-saving LED solutions. Specification: colour temperature 3000K, 4000K; CRI>80; lifespan of LED panels 50 000 hours (L70B50) $t_a = 25^\circ\text{C}$.

LIGHT BEAM CURVES

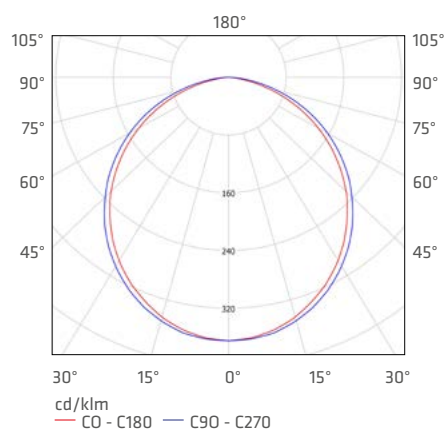

APPLICATION

Luminaire is dedicated for indoor use. Due to good lighting of the surface and even light distribution, it is particularly well-suited to be used as the main light source in representative rooms and passageways. The fitting's design is suitable for surface or recessed mounting in plasterboard ceilings.

SURFACE MOUNTING:

CORIA LED

IK07 | IP40 | 

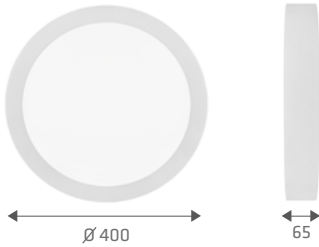

2,50  KG

rated power [W]	colour temperature [K]	total luminous flux* [lm]	diffuser	EEL	index
30	3000	2850	OPAL	A	472671
30	4000	3000	OPAL	A	472664

RECESSED MOUNTING:

CORIA LED

IK07 | IP40 | 



Ø 425 
2,65  KG

rated power [W]	colour temperature [K]	total luminous flux* [lm]	diffuser	EEL	index
30	3000	2850	OPAL	A	472695
30	4000	3000	OPAL	A	472688

* Initial, tolerance +/- 10%



PLANO II LED

OFFICE LIGHTING

LED GO!



SPECIFICATION

Ingress protection class:	IP20
Total luminous flux*:	max. 4400lm (4000K)
Colour temperature (CCT):	3000K, 4000K
Energy efficiency class (EEI):	A
Power supply:	220-240V / 50-60Hz
Mounting:	surface / suspended / recessed in modular ceiling / recessed in plasterboard ceiling (mounting kit included)
Body:	aluminium
Diffuser:	PMMA OPAL

Versatile LED luminaire available in various sizes, characterized by low profile with smooth and elegant design, for recessed modular or plasterboard ceiling systems as well as surface or suspended mounting. Luminaire with built-in energy saving LED GO! light source, made from anodized grey aluminium, equipped with multilayer PMMA diffuser providing perfect light dispersion and low glare. Colour temperature 3000K/4000K, CRI>80, lifespan of LED 50 000h (L70B50) $t_a=25^{\circ}\text{C}$.

LIGHT BEAM CURVES

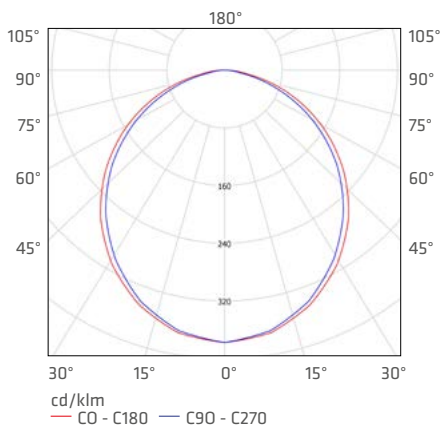

APPLICATION

Versatile luminaire for indoor application in offices, conference rooms or general use in representative areas such as hotels and restaurants. Suitable for task lighting even when eyesight concentration is required. As well as new installations, it is an ideal energy saving replacement solution for conventional T8 & T5 luminaires.

PLANO II LED

OFFICE LIGHTING

SUSPENDED MOUNTED:

PLANO II LED 250

IP20 | 



3,00 KG 

rated power [W]	colour temperature [K]	total luminous flux* [lm]	diffuser	EEL	index
22	3000	1500	OPAL	A	453526
22	4000	1600	OPAL	A	453557

PLANO II LED 600

IP20 | 



6,10 KG 

rated power [W]	colour temperature [K]	total luminous flux* [lm]	diffuser	EEL	index
32	3000	2750	OPAL	A	453588
32	4000	3000	OPAL	A	453618
52	3000	4000	OPAL	A	453649
52	4000	4400	OPAL	A	453670

PLANO II LED 1200

IP20 | 



5,50 KG 

rated power [W]	colour temperature [K]	total luminous flux* [lm]	diffuser	EEL	index
52	3000	4000	OPAL	A	453700
52	4000	4400	OPAL	A	453731

* Initial, tolerance +/- 10%



PLANO II LED

OFFICE LIGHTING

RECESSED IN MODULAR CEILING:

PLANO II LED 250

IP20 | 



MODULE CEILING
250/250

2,20  KG

rated power [W]	colour temperature [K]	total luminous flux* [lm]	diffuser	EEl	index
22	3000	1500	OPAL	A	453281
22	4000	1600	OPAL	A	453311

PLANO II LED 600

IP20 | 



MODULE CEILING
600/600

5,00  KG

rated power [W]	colour temperature [K]	total luminous flux* [lm]	diffuser	EEl	index
32	3000	2750	OPAL	A	453342
32	4000	3000	OPAL	A	453373
52	3000	4000	OPAL	A	453403
52	4000	4400	OPAL	A	453434

PLANO II LED 1200

IP20 | 



MODULE CEILING
1200/300

5,20  KG

rated power [W]	colour temperature [K]	total luminous flux* [lm]	diffuser	EEl	index
52	3000	4000	OPAL	A	453465
52	4000	4400	OPAL	A	453496

SURFACE MOUNTED:

PLANO II LED 640

IP20 | 



6,50  KG

rated power [W]	colour temperature [K]	total luminous flux* [lm]	diffuser	EEl	index
22	3000	1900	OPAL	A	453243
22	4000	2100	OPAL	A	453250
44	3000	3400	OPAL	A	453267
44	4000	3750	OPAL	A	453274

PLANO II LED

OFFICE LIGHTING

RECESSED IN PLASTERBOARD CEILING:

PLANO II KG LED 250

IP20 | 

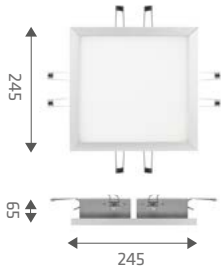

225/225 

2,60  KG

rated power [W]	colour temperature [K]	total luminous flux* [lm]	diffuser	EEl	index
22	3000	1500	OPAL	A	453007
22	4000	1600	OPAL	A	453038

PLANO II KG LED 600

IP20 | 

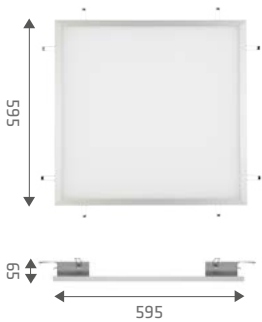

565/565 

5,30  KG

rated power [W]	colour temperature [K]	total luminous flux* [lm]	diffuser	EEl	index
32	3000	2750	OPAL	A	453069
32	4000	3000	OPAL	A	453090
52	3000	4000	OPAL	A	453120
52	4000	4400	OPAL	A	453151

PLANO II KG LED 1200

IP20 | 

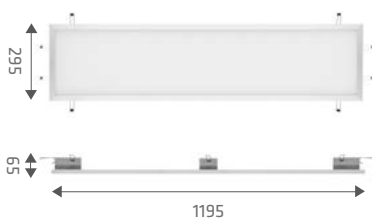

1165/270 

5,60  KG

rated power [W]	colour temperature [K]	total luminous flux* [lm]	diffuser	EEl	index
52	3000	4000	OPAL	A	453182
52	4000	4400	OPAL	A	453212

* Initial, tolerance +/- 10%



PLANO II LED

OFFICE LIGHTING

RECESSED IN PLASTERBOARD CEILING (FRAMELESS VERSIONS):

ACCESSORIES

index	dimensions [mm]	installation dimensions [mm]	weight [kg]
312835	280x280	280x280	0,29
312842	630x230	630x230	0,47
312828	630x630	630x630	0,70
312858	1230x230	1230x230	0,83
312865	1230x330	1230x330	0,89

TECHNICAL DETAILS



Frame for recessed mounting

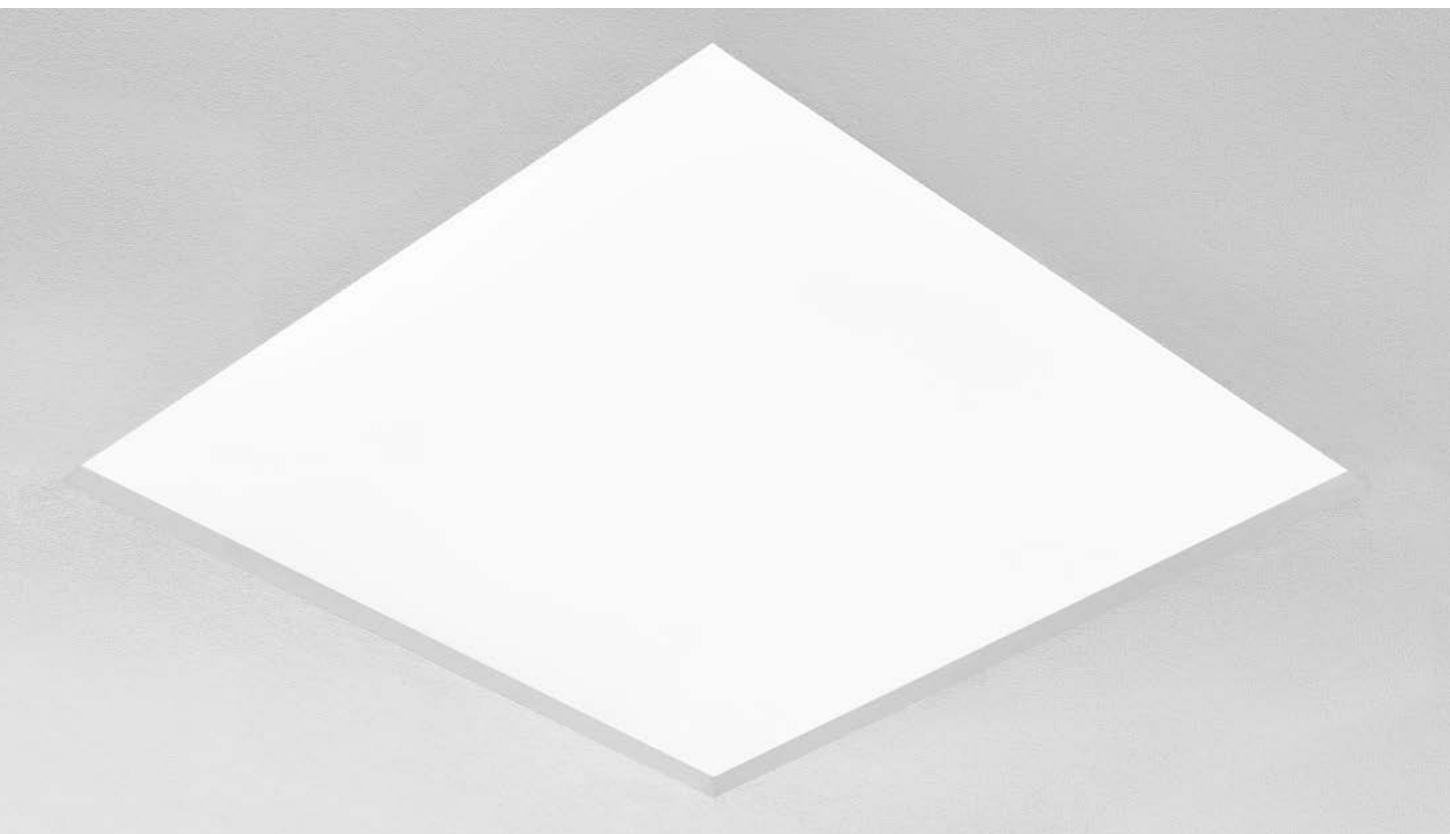



PLANO LED

OFFICE LIGHTING

LED

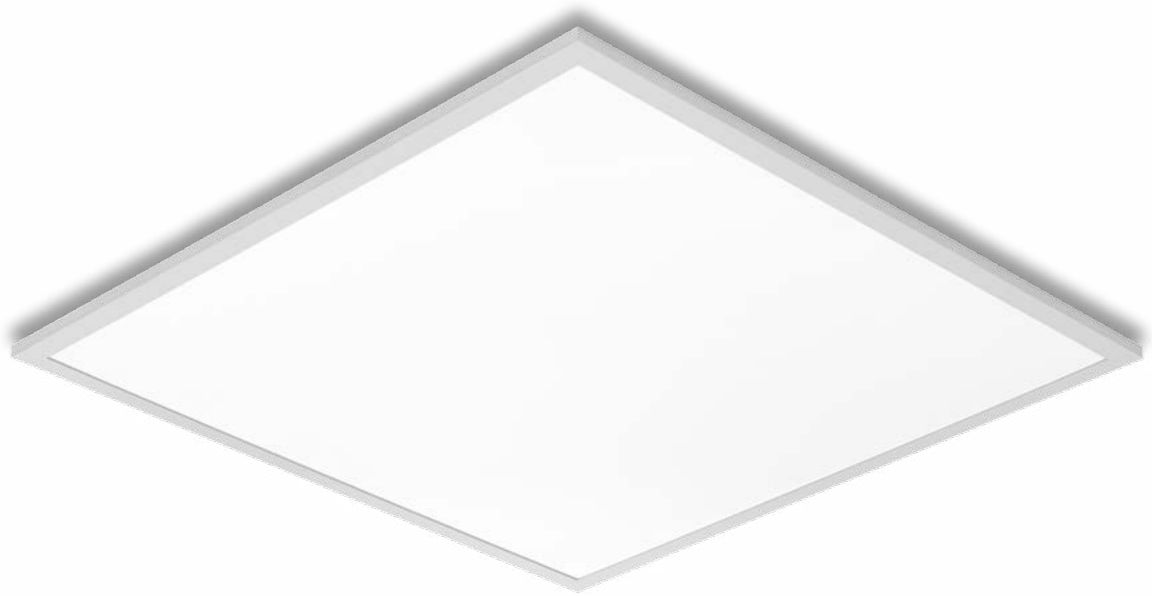

SPECIFICATION

Ingress protection class:	IP20	Versatile LED luminaire characterized by low profile with smooth and elegant design, for recessed modular ceiling systems. Luminaire with built-in energy saving LED light source, made from aluminium (white colour), equipped with multilayer PMMA diffuser providing perfect light dispersion and low glare. Colour temperature 3000K/4000K, CRI>80, lifespan of LED 50 000h (L70B50) $t_a= 25^{\circ}\text{C}$.
Total luminous flux*:	max. 3150lm (4000K)	
Colour temperature (CCT):	3000K, 4000K	
Energy efficiency class (EEI):	A	
Power supply:	220-240V / 50-60Hz	
Mounting:	recessed in modular ceiling	
Body:	aluminium white	
Diffuser:	PMMA OPAL	

LIGHT BEAM CURVES

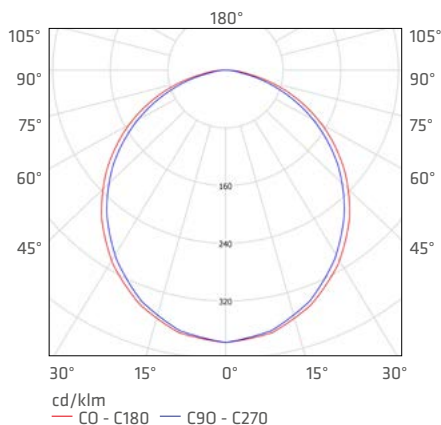

APPLICATION

Versatile luminaire for indoor application in offices (studios, conference rooms) or general use in representative areas. Unique design and perfect lighting parameters allow applying PLANO LED as the main light source even when the work requires eyesight concentration. It is appropriate for new applications as well as for replacing conventional T8 & T5 fittings with energy-saving LED solutions. Designed to be mounted in modular ceiling 600x600.

PLANO LED

OFFICE LIGHTING

PLANO LED



IP20 |

rated power [W]	colour temperature [K]	total luminous flux* [lm]	diffuser	EEL	index
34	3000	2850	OPAL	A	011580
34	4000	3150	OPAL	A	011573

MODULE CEILING
600/600

2,25 KG

* Initial, tolerance +/- 10%
Available options: **DALI**





SPECIFICATION

Ingress protection class:	IP20	Suspended or recessed very narrow luminaire including an integrated, energy-saving LED GO! light source. Body made from grey anodized aluminium,. The optical system available in two versions: metalized plastic louver or highly uniform opal diffuser. The fitting is equipped with a unique suspension system facilitating installation and adjustment of the slings. A five-pole terminal block, delivered as standard, shortens installation time and allows to connect cables without opening the fitting. Optional equipment: ballast compatible with the DALI MASTER standard. Colour temperature 3000K/4000K, CRI>80, lifespan of LED 50 000h (L70B50) $t_a=25^{\circ}\text{C}$.
Total luminous flux*:	max. 4550lm (4000K)	
Colour temperature (CCT):	3000K, 4000K	
Energy efficiency class (EEI):	A	
Power supply:	220-240V / 50-60Hz	
Mounting:	suspended / recessed in plasterboard ceiling (mounting kit not included)	
Body:	aluminium, plastic end caps	
Diffuser:	PMMA OPAL, HE	

LIGHT BEAM CURVES

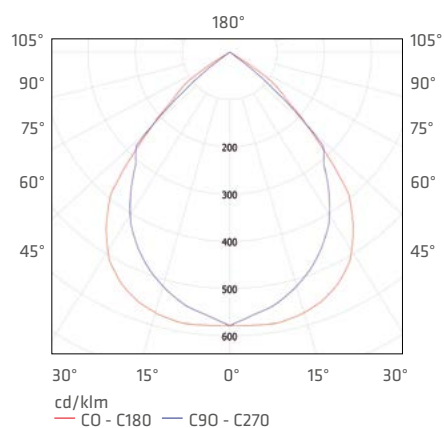

APPLICATION

Particularly well suited for indoor use. Suitable as the primary light source dedicated for office work requiring eyesight concentration or work with computers (UGR<19). Luminaire designed to create continuous-row system with option for through-wiring. May also be used in representative rooms. Unique design, energy saving LED GO! light sources and compatibility with external lighting control systems in the DALI standard make this fitting a good solution for use in modern A-class office buildings.

SUSPENDED MOUNTING:

SMART LED HE 1300

IP20 

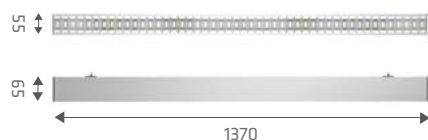

2,10  **KG** DALI 1,80  **KG**

rated power [W]	colour temperature [K]	total luminous flux* [lm]	diffuser	sensor	EEL	index
20	3000	1650	HE	-	A	544361
20	4000	1750	HE	-	A	544002
20	3000	1650	HE	DALI	A	544385
20	4000	1750	HE	DALI	A	544040
40	3000	3550	HE	-	A	544477
40	4000	3800	HE	-	A	544019
40	3000	3550	HE	DALI	A	544491
40	4000	3800	HE	DALI	A	544057

SMART LED HE 1600

IP20 

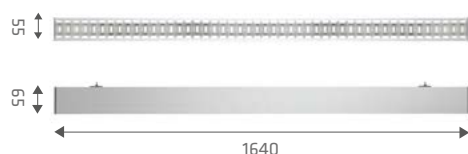



2,50  **KG** DALI 2,20  **KG**

rated power [W]	colour temperature [K]	total luminous flux* [lm]	diffuser	sensor	EEL	index
24	3000	1950	HE	-	A	544422
24	4000	2100	HE	-	A	544026
24	3000	1950	HE	DALI	A	544439
24	4000	2100	HE	DALI	A	544064
48	3000	4250	HE	-	A	544149
48	4000	4550	HE	-	A	544033
48	3000	4250	HE	DALI	A	544521
48	4000	4550	HE	DALI	A	544071

SMART LED OPAL 1130

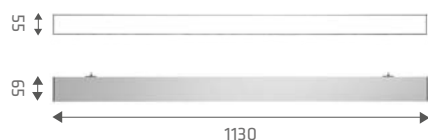
IP20 



2,00  **KG** DALI 1,70  **KG**



rated power [W]	colour temperature [K]	total luminous flux* [lm]	diffuser	sensor	EEL	index
30	3000	2400	OPAL	-	A	547935
30	4000	2600	OPAL	-	A	547942
30	3000	2400	OPAL	DALI	A	547997
30	4000	2600	OPAL	DALI	A	544170
48	3000	3900	OPAL	-	A	547928
48	4000	4200	OPAL	-	A	547911
48	3000	3900	OPAL	DALI	A	547966
48	4000	4200	OPAL	DALI	A	547959

* Initial, tolerance +/- 10%

SMART LED

OFFICE LIGHTING

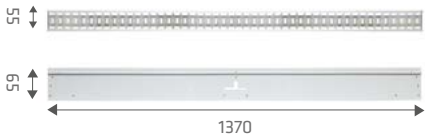
RECESSED MOUNTING (FRAMELESS)

SMART LED HE 1300	IP20	rated power [W]	colour temperature [K]	total luminous flux* [lm]	diffuser	sensor	EEL	index
 		20	4000	1750	HE	-	A	547126
		20	4000	1750	HE	DALI	A	547201
		40	4000	3800	HE	-	A	547447
		40	4000	3800	HE	DALI	A	547522

* Initial, tolerance +/- 10%

TECHNICAL DETAILS



Smart LED HE (frameless version)



Frame for recessed mounting

ACCESSORIES

index	article name
544125	line connector
171512	single suspended cord
171505	single electrical suspended cord (round box)
171635	single suspended cord (round box)
171574	single electrical suspended cord (square box)
171642	single suspended cord (square box)

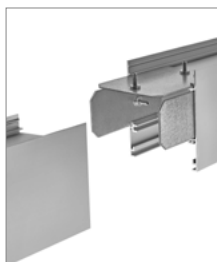

544125



171512



171505



171635



171574



171642



INTEGRA LED

OFFICE LIGHTING

LED GO!



SPECIFICATION

Ingress protection class:	IP20
Total luminous flux*:	max. 5700lm (4000K)
Colour temperature (CCT):	3000K, 4000K
Energy efficiency class (EEI):	A+, A
Power supply:	220-240V / 50-60Hz
Mounting:	surface / suspended
Body:	aluminium, steel
Diffuser:	PMMA OPAL, PRM

System of LED decorative, suspended office luminaires made from a high quality materials (silver anodized aluminium profile type C-0) for internal use. INTEGRA CUBE connector system allows designing light lines in a variety of configurations (I, T, X, L). INTEGRA DECO LED version equipped with LED indirect light provides a combination of high light parameters and decorative effects. The system is available in versions with DIMM/DALI and MASTER (IDIM DALI) control systems. It is simple to use and install and user friendly. Colour temperature 3000K/4000K, CRI>80, lifespan of LED 50 000h (L70B50) $t_a=25^{\circ}\text{C}$.

LIGHT BEAM CURVES

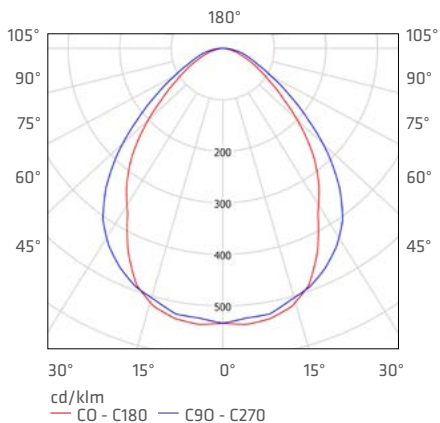

APPLICATION

Luminaire dedicated for internal use. For use in office and commercial buildings, and in particular in the representational spaces.

INTEGRA LED

OFFICE LIGHTING

INTEGRA LED 24W

IP20 



2,8  KG

rated power [W]	colour temperature [K]	total luminous flux* [lm]	diffuser	accent light colour	EEl	index
24	3000	1850	OPAL	-	A	523007
24	3000	1850	OPAL	WHITE	A	523014
24	4000	2050	OPAL	-	A	523021
24	4000	2050	OPAL	WHITE	A	523038
24	3000	1900	PRM	-	A	524004
24	3000	1900	PRM	WHITE	A	524141
24	4000	2000	PRM	-	A	524011
24	4000	2000	PRM	WHITE	A	524158

INTEGRA LED 32W

IP20 



3,5  KG

rated power [W]	colour temperature [K]	total luminous flux* [lm]	diffuser	accent light colour	EEl	index
32	3000	2450	OPAL	-	A	523045
32	3000	2450	OPAL	WHITE	A	523052
32	4000	2750	OPAL	-	A	523069
32	4000	2750	OPAL	WHITE	A	523076
32	3000	2400	PRM	-	A	524028
32	3000	2400	PRM	WHITE	A	524165
32	4000	2600	PRM	-	A	524035
32	4000	2600	PRM	WHITE	A	524172

INTEGRA LED 40W

IP20 



4,3  KG

rated power [W]	colour temperature [K]	total luminous flux* [lm]	diffuser	accent light colour	EEl	index
40	3000	3100	OPAL	-	A	523083
40	3000	3100	OPAL	WHITE	A	523090
40	4000	3450	OPAL	-	A	523106
40	4000	3450	OPAL	WHITE	A	523113
40	3000	2950	PRM	-	A	524042
40	3000	2950	PRM	WHITE	A	524189
40	4000	3250	PRM	-	A	524059
40	4000	3250	PRM	WHITE	A	524196

INTEGRA LED 48W

IP20 

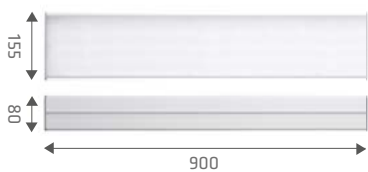

4,2  KG

rated power [W]	colour temperature [K]	total luminous flux* [lm]	diffuser	accent light colour	EEl	index
48	3000	4050	OPAL	-	A	523120
48	3000	4050	OPAL	WHITE	A	523137
48	4000	4500	OPAL	-	A	523144
48	4000	4500	OPAL	WHITE	A	523151
48	3000	3900	PRM	-	A	524080
48	3000	3900	PRM	WHITE	A	524226
48	4000	4350	PRM	-	A	524097
48	4000	4350	PRM	WHITE	A	524233

* Initial, tolerance +/- 10%

INTEGRA LED

OFFICE LIGHTING

INTEGRA LED 60W

IP20 | 

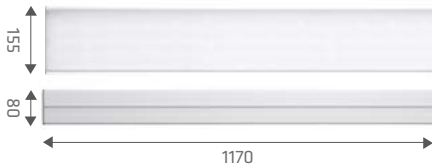

5,4  KG

rated power [W]	colour temperature [K]	total luminous flux* [lm]	diffuser	accent light colour	EEL	index
60	3000	5300	OPAL	-	A	523168
60	3000	5300	OPAL	WHITE	A	523175
60	4000	5700	OPAL	-	A+	523182
60	4000	5700	OPAL	WHITE	A+	523199
60	3000	4850	PRM	-	A	524103
60	3000	4850	PRM	WHITE	A	524240
60	4000	5400	PRM	-	A	524110
60	4000	5400	PRM	WHITE	A	524257

* Initial, tolerance +/- 10%

Available options: **DIMM / DALI, MASTER (iDim DALI)**

TECHNICAL DETAILS



DECO LED accent light



„L“ type connection



„X“ type connection



„T“ type connection

ACCESSORIES

index	article name	notes
531583	Integra Cube connector	for Integra LED 24W, 32W & 40W versions
531590	Integra Led Cube 3W 4000K connector	for Integra LED 24W, 32W & 40W versions
171512	single suspended cord	-
171581	DALI single electrical suspended cord (round box)	-
171505	single electrical suspended cord (round box)	-
171635	single suspended cord (round box)	-
171574	single electrical suspended cord (square box)	-
171598	DALI single electrical suspended cord (square box)	-
171642	single suspended cord (square box)	-



Integra „CUBE” connector (531583)



Integra „CUBE LED” 3W 4000K connector (531590)



171512



171505, 171581 (DALI)



171635



171574, 171598 (DALI)



171642



PRM diffuser



OPAL diffuser

INTEGRA LED WALL LIGHTS

OFFICE LIGHTING

LED GO!



SPECIFICATION

Ingress protection class:	IP20
Total luminous flux*:	max. 2100lm (4000K)
Colour temperature (CCT):	4000K
Energy efficiency class (EEI):	A
Power supply:	220-240V / 50-60Hz
Mounting:	surface
Body:	aluminium, steel
Diffuser:	PC OPAL

The decorative office LED luminaires made of the highest quality materials (silver anodized aluminium profile C-0). User-friendly, easy service and installation. The system is designed for wall mounting. Specification: colour temperature 4000K; CRI>80; lifespan of LED panels 50 000 hours (L70B50) $t_a = 25^\circ\text{C}$

LIGHT BEAM CURVES

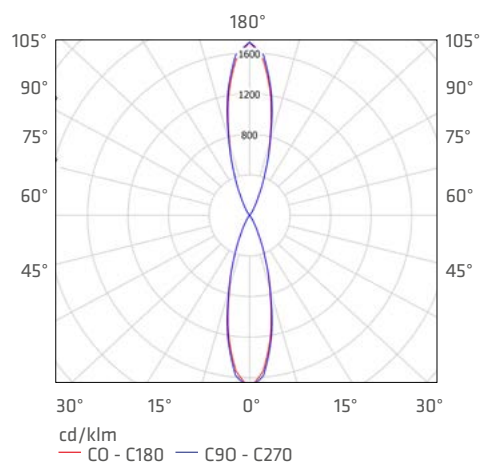

APPLICATION

The luminaire is dedicated for indoor use. It is widely used in offices and commercial buildings, particularly in representative rooms.

INTEGRA LED WALL LIGHTS

OFFICE LIGHTING

INTEGRA LED K2	IP20 	rated power [W]	colour temperature [K]	total luminous flux* [lm]	diffuser	dimensions A/B/C [mm]	EEL	index
 		6	4000	520	OPAL	110/80/80	A	530579
INTEGRA LED P1	IP20 	rated power [W]	colour temperature [K]	total luminous flux* [lm]	diffuser	dimensions A/B/C [mm]	EEL	index
 		24	4000	1900	OPAL	80/80/1000	A	529696
INTEGRA LED P2	IP20 	rated power [W]	colour temperature [K]	total luminous flux* [lm]	diffuser	dimensions A/B/C [mm]	EEL	index
 		24	4000	2100	OPAL	80/80/1000	A	529689

* Initial, tolerance +/- 10%

TECHNICAL DETAILS



Integra LED K2



Integra LED P1



Integra LED P2

DECO LINE LED

OFFICE LIGHTING

LED GO!



SPECIFICATION

Ingress protection class:	IP20
Total luminous flux*:	max. 3000lm (4000K)
Colour temperature (CCT):	3000K, 4000K
Energy efficiency class (EEI):	A+, A
Power supply:	220-240V / 50-60Hz
Mounting:	recessed
Body:	aluminium
Diffuser:	HE (high efficiency reflector)

System of office fittings for recessed mounting. Optics have been designed in two options patented reflector that guarantees efficiency at the level of 88% and effectively reduces glare effect or high performance opal cover providing even light distribution. CUBE DECO LINE connector permits to design recessed lighting lines in different configurations (I, T, X, L). The system provides a combination of high efficiency and decorative effects. Features: colour temperature 3000K, 4000K; CRI>80; lifespan of LED 50 000h (L70B50) $t_a=25^{\circ}\text{C}$.

LIGHT BEAM CURVES

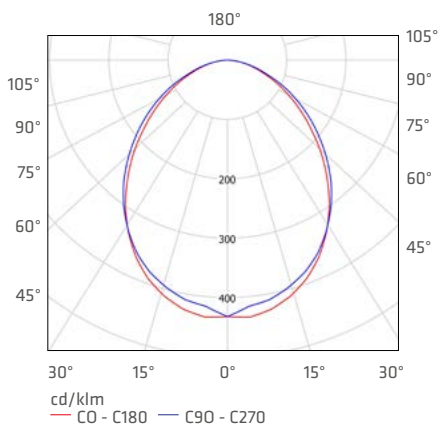

APPLICATION

Luminaire dedicated for internal use. For use in office and commercial buildings, and in particular in the representational spaces.

DECO LINE LED

OFFICE LIGHTING

DECO LINE LED

IP20 | 

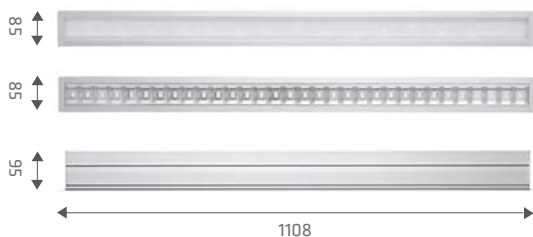

3,2  KG

rated power [W]	colour temperature [K]	total luminous flux* [lm]	reflector/diffuser	EEl	index
16	3000	1350	HE	A	480041
16	4000	1450	HE	A	480010
16	3000	1130	OPAL	A	480058
16	4000	1220	OPAL	A	480003
32	3000	2750	HE	A	480065
32	4000	3000	HE	A	480034
32	3000	2350	OPAL	A	480072
32	4000	2500	OPAL	A	480027

CONTINUOUS LINE FITTINGS:

DECO LINE LED INITIAL/END (MODULE „P/K”)

IP20 | 

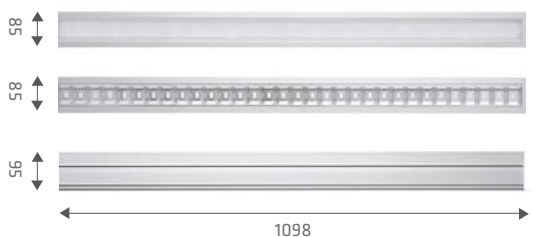

3,2  KG

rated power [W]	colour temperature [K]	total luminous flux* [lm]	reflector/diffuser	EEl	index
16	3000	1350	HE	A	480126
16	4000	1450	HE	A	480089
16	3000	1130	OPAL	A	480133
16	4000	1220	OPAL	A	480096
32	3000	2750	HE	A	480140
32	4000	3000	HE	A	480102
32	3000	2350	OPAL	A	480157
32	4000	2500	OPAL	A	480119

DECO LINE LED CONTINUOUS LINE (MODULE „S”)

IP20 | 

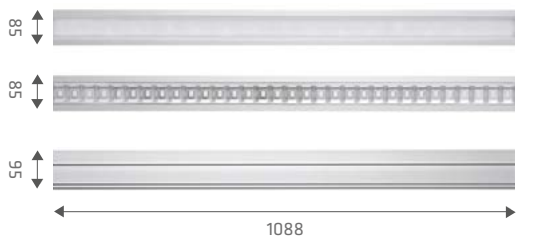

3,2  KG

rated power [W]	colour temperature [K]	total luminous flux* [lm]	reflector/diffuser	EEl	index
16	3000	1350	HE	A	480201
16	4000	1450	HE	A	480164
16	3000	1130	OPAL	A	480218
16	4000	1220	OPAL	A	480171
32	3000	2750	HE	A	480225
32	4000	3000	HE	A	480188
32	3000	2350	OPAL	A	480232
32	4000	2500	OPAL	A	480195

* Initial, tolerance +/- 10%

Available options: **DIMM 1-10V, DALI.**

DECO LINE LED

OFFICE LIGHTING

ACCESSORIES

index	name	dimensions [mm]	weight[kg]
480244	DECO LINE SYSTEM Cube "L"	85x85x96	0,4
480256	DECO LINE SYSTEM Cube "T"	85x85x96	0,4
480263	DECO LINE SYSTEM Cube "X"	85x85x96	0,4

TECHNICAL DETAILS



„L“ type light line



„X“ type light line



„I“ type light line



„CUBE“ connector



LIGHT LINE EXAMPLES

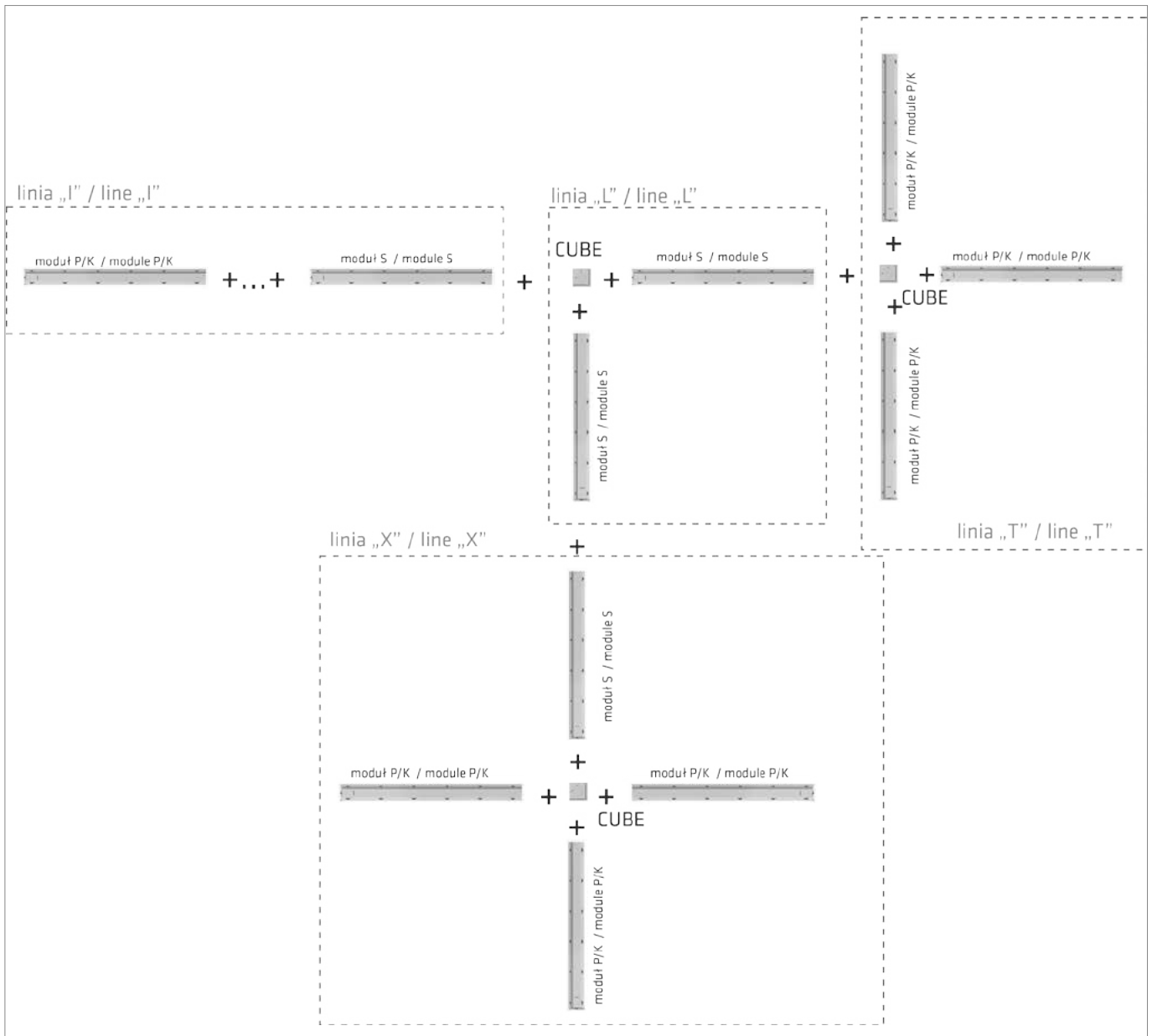

CLEO II LED

OFFICE LIGHTING

LED GO!



SPECIFICATION

Ingress protection class:	IP20
Total luminous flux*:	max. 4900lm (4000K)
Colour temperature (CCT):	3000K, 4000K
Energy efficiency class (EEI):	A
Power supply:	220-240V / 50-60Hz
Mounting:	surface / suspended (mounting kit included)
Body:	powder coated steel
Optical system:	PMMA transparent diffuser aluminium reflector

Surface mounted or suspended square LED luminaire with energy saving LED GO! modules, made from powder coated grey steel sheet. Optic system combines high transparency clear diffuser and aluminium louver providing low glare (UGR<19). Features: 3000/4000K colour temperature, CRI>80, lifespan of LED 50 000h (L70B50) $t_a = 25^\circ\text{C}$.

LIGHT BEAM CURVES

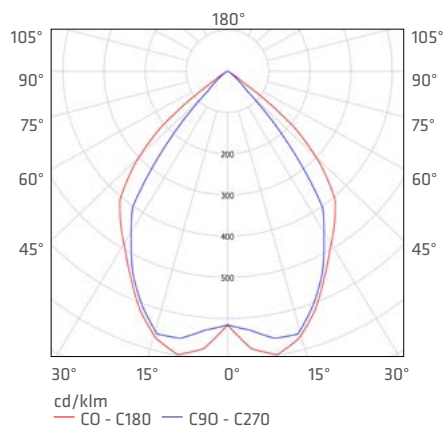

APPLICATION

Luminaire for indoor application in offices, conference rooms. It is perfect for representational spaces like hotels or restaurants. Unique design and excellent performance allow using CLEO II LED as the main lighting units.

CLEO II LED

OFFICE LIGHTING

CLEO II LED

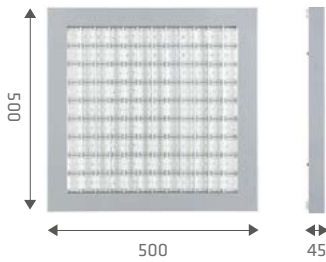

IP20

rated power [W]	colour temperature [K]	total luminous flux* [lm]	diffuser	EEl	index
54	3000	4500	CLR	A	472794
54	4000	4900	CLR	A	472770

3,92

SUSPENDED MOUNTING:

CLEO II LED

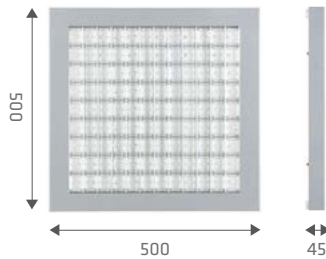

IP20

rated power [W]	colour temperature [K]	total luminous flux* [lm]	diffuser	EEl	index
54	3000	4500	CLR	A	472800
54	4000	4900	CLR	A	472787

4,50

* Initial, tolerance +/- 10%

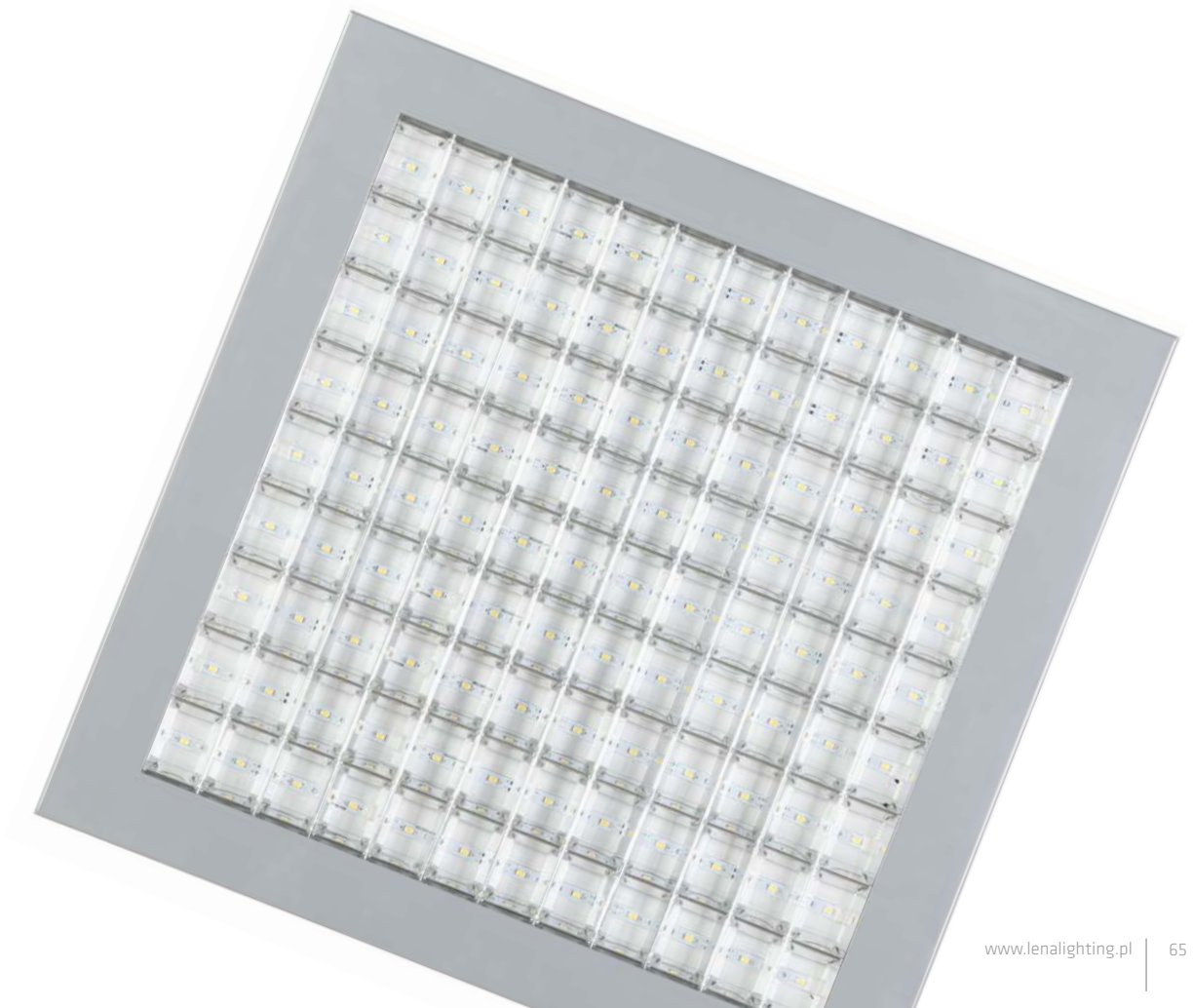

TERRA LED

OFFICE LIGHTING

LED GO!



SPECIFICATION

Ingress protection class:	IP20
Total luminous flux*:	max. 5400lm (4000K)
Colour temperature (CCT):	3000K/4000K
Energy efficiency class (EEI):	A
Power supply:	220-240V / 50-60Hz
Mounting:	surface / recessed in modular ceiling
Body:	powder coated steel
Optical system:	HE reflector

Recessed square LED luminaire with high total luminous flux, equipped with energy saving LED GO! modules. Made from powder coated white steel sheet. The luminaire has a patented HE reflector installed ensuring efficiency at the level of 88 %, which also effectively eliminates glare. Unique mounting system allows suspend the luminaire for installation purpose. Features: 4000K colour temperature, CRI>80, lifespan of LED 50 000h (L70B50) $t_a = 25^\circ\text{C}$.

LIGHT BEAM CURVES

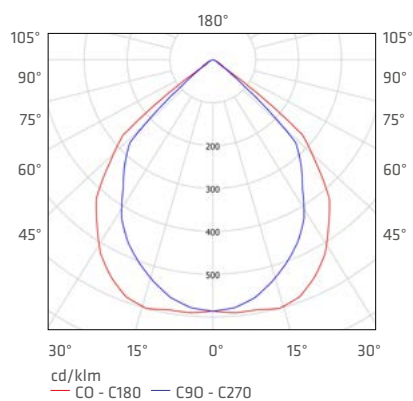

APPLICATION

General purpose recessed luminaire for indoor application in offices or other utility rooms. Appropriate as the main light source even when the work requires eyesight concentration. Well suited for new applications as well as replacing conventional T8 & T5 with energy-saving solutions. Construction adapted for surface mounting and recessed installation in modular ceilings.

TERRA LED

OFFICE LIGHTING

TERRA LED

IP20 

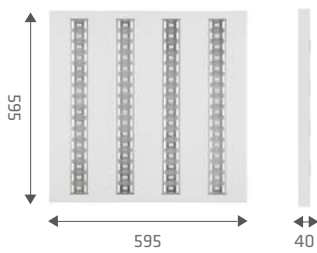

rated power [W]	colour temperature [K]	total luminous flux* [lm]	reflector	EEI	weight [kg]	index
32	3000	2500	HE	A	4,8	226083
32	4000	2700	HE	A	4,8	226021
32	3000	5000	HE	A	5,2	226090
64	4000	5400	HE	A	5,2	226038

* Initial, tolerance +/- 10%

ACCESSORIES

index	article name
226045	bracket for surface mounting

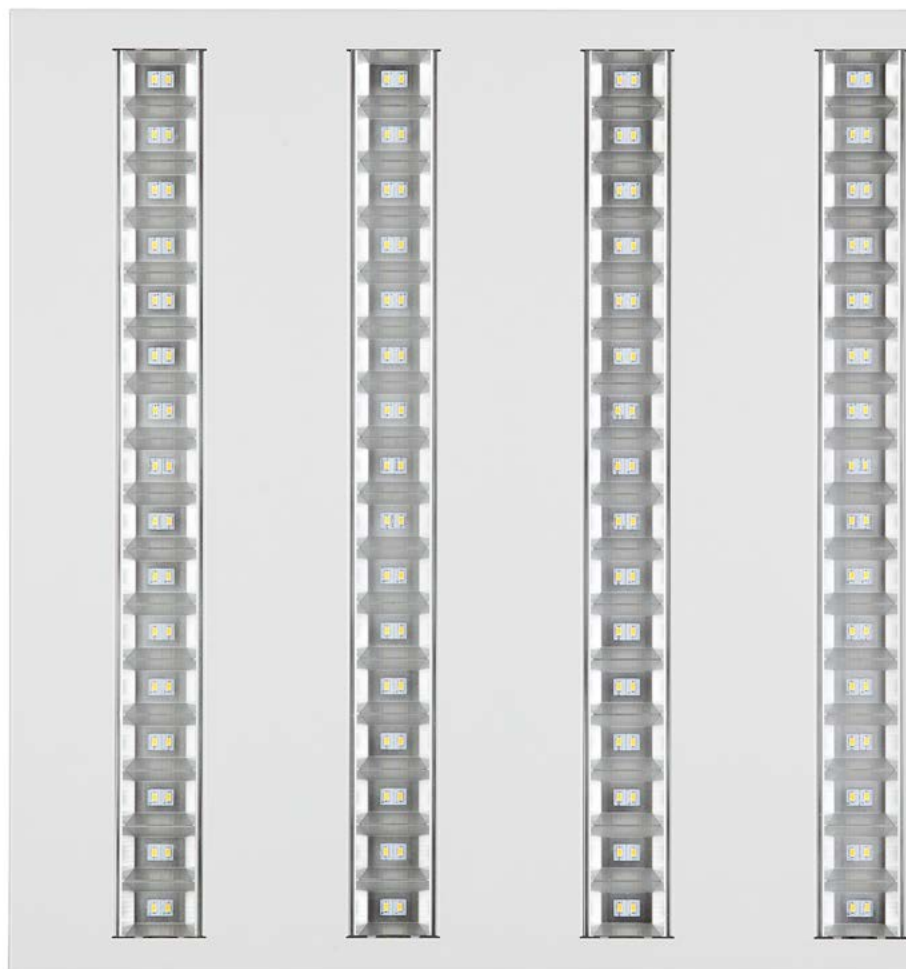



SPECIFICATION

Ingress protection class:	IP20
Total luminous flux*:	max. 2600lm (4000K)
Colour temperature (CCT):	4000K
Energy efficiency class (EEI):	A
Power supply:	220-240V / 50-60Hz
Mounting:	recessed in modular ceiling
Body:	powder coated steel
Reflector:	powder coated steel
Cover:	micro-perforated white powder coated steel

Recessed mounted square luminaire with an integrated energy-saving LED GO! light source. Powder-coated steel body. The lens diffuser is made of perforated metal sheet and provides comfortable and soft light. Features: 4000K colour temperature, CRI>80, lifespan of LED 50 000h (L70B50) $t_a=25^{\circ}\text{C}$.

LIGHT BEAM CURVES

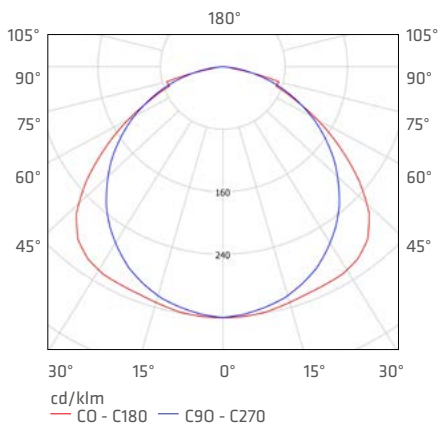

APPLICATION

A versatile indoor luminaire designed for office rooms and areas of general public use. Suitable as a general light source for all sorts of work that require optical focus. Dedicated for new applications and as a replacement of traditional T8 and T5 tube luminaires with energy-saving LED lamps.

INDO LED

IP20 

rated
power [W]

colour
temperature [K]

total luminous
flux* [lm]

EEL

index

30

4000

2600

A

380099

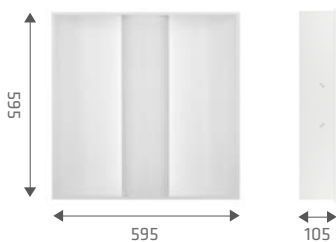

MODULE CEILING
600/600

3,8  KG

* Initial, tolerance +/- 10%

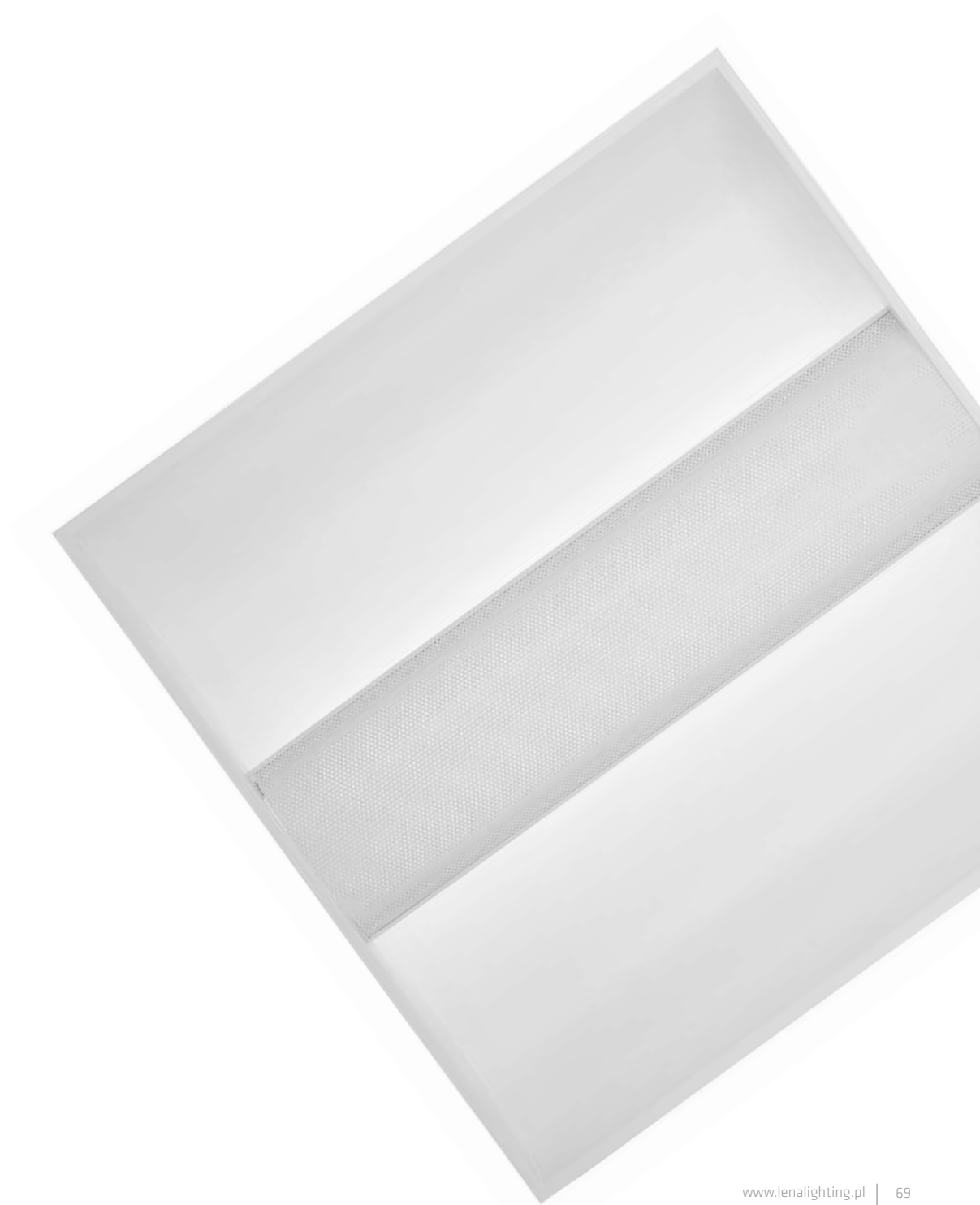

INDO PLX LED

OFFICE LIGHTING

LED GO!



SPECIFICATION

Ingress protection class:	IP20
Total luminous flux*:	max. 3250lm (4000K)
Colour temperature (CCT):	3000K, 4000K
Energy efficiency class (EEI):	A
Power supply:	220-240V / 50-60Hz
Mounting:	recessed in modular ceiling
Body:	powder coated steel
Reflector:	powder coated steel
Cover:	micro-perforated white powder coated steel; PMMA OPAL

Recessed mounted square luminaire with an integrated energy-saving LED GO! light source. Powder-coated steel body. The lens diffuser is made of perforated metal sheet and PMMA. It provides comfortable and soft light. Features: 3000K/4000K colour temperature, CRI>80, lifespan of LED 50 000h (L70B50) $t_a= 25^{\circ}\text{C}$.

LIGHT BEAM CURVES

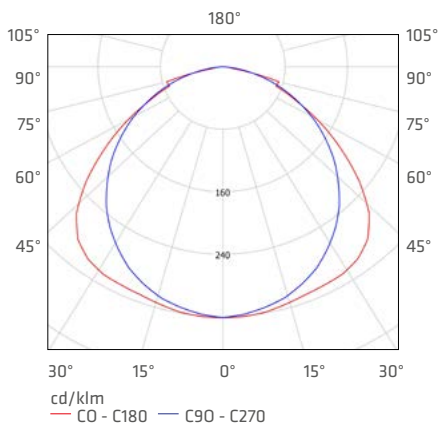

APPLICATION

A versatile indoor luminaire designed for office rooms and areas of general public use. Suitable as a general light source for all sorts of work that require optical focus. Dedicated for new applications and as a replacement of traditional T8 and T5 tube luminaires with energy-saving LED lamps.

INDO PLX LED

OFFICE LIGHTING

INDO PLX LED

IP20 

moc
nominalna
[W]

temperatura
barwowa [K]

strumień świetlny
oprawy* [lm]

EEL

indeks

34

3000

3000

A

380235

34

4000

3250

A

380228

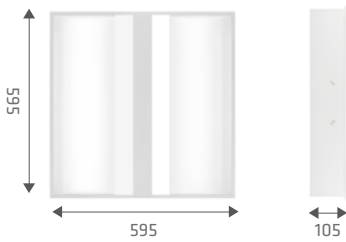

MODULE CEILING
600/600

3,8  KG

* Initial, tolerance +/- 10%





SPECIFICATION

Ingress protection class:	IP65
Total luminous flux*:	max. 12150lm (4000K)
Colour temperature (CCT):	4000K
Energy efficiency class (EEI):	A
Power supply:	220-240V / 50-60Hz
UGR:	<19
Mounting:	surface / recessed in modular ceiling
Body:	powder coated steel
Diffuser:	PMMA transparent + HE reflector / PMMA OPAL diffuser

Fitting with high ingress protection class IP65, suitable for surface and flush mounting in modular ceilings. It is equipped with patented HE reflector which reduces the effect of glare. Available with prismatic or opal diffuser. Option with a colour rendering index CRI (Ra)>90 available on request. Specification: colour temperature 4000K; CRI>80; lifespan of LED panels: 50 000 hours (L70B50) $t_a = 25^\circ\text{C}$

APPLICATION

Luminaire intended for indoor use in medical and laboratory rooms as well as in industrial facilities (especially in food, pharmaceuticals, cosmetics), where you need high ingress protection class and the highest lighting parameters.

LIGHT BEAM CURVES

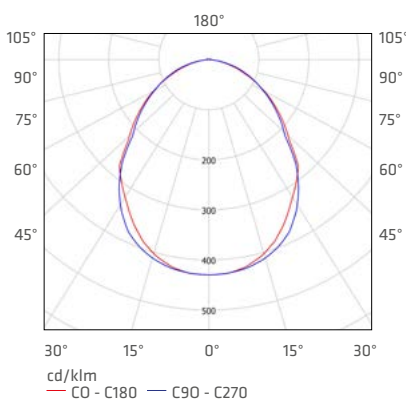

CRI (Ra) >90 (on request)

CRI index (Ra) is a factor determining the degree of colour rendering. The higher the value, the more natural the colours. Ra>90 means comfort for the eyes and greater ability to recognize colours and their shades. Fittings with such a high rate are used in rooms where high accuracy in colour rendering is required (operating rooms, surgeries).

RECESSED MOUNTING:

LABO LED 595x595

IP65 

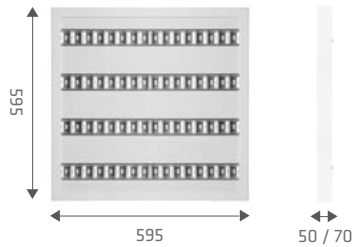

595x595x50 - dimension variant I
595x595x70 - dimension variant II

rated power [W]	colour temperature [K]	total luminous flux* [lm]	reflector/ diffuser	EEL	dimension variant	weight [kg]	index
32	4000	2850	HE/TRANSP.	A	I	7,6	259005
48	4000	3850	-/OPAL	A	II	5,5	259050

LABO LED 295x1195

IP65 

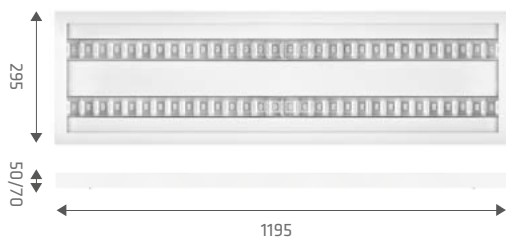

295x1195x50 - dimension variant I
295x1195x70 - dimension variant II

rated power [W]	colour temperature [K]	total luminous flux* [lm]	reflector/ diffuser	EEL	dimension variant	weight [kg]	index
32	4000	2850	HE/TRANSP.	A	I	7,6	259012
48	4000	3850	-/OPAL	A	II	5,5	259067
64	4000	5100	HE/TRANSP.	A	I	8,1	259029

LABO LED 595x1195

IP65 



595x1195x50 - dimension variant I
595x1195x70 - dimension variant II

rated power [W]	colour temperature [K]	total luminous flux* [lm]	reflector/ diffuser	EEL	dimension variant	weight [kg]	index
64	4000	5100	HE/TRANSP.	A	I	14,0	259036
96	4000	7650	-/OPAL	A	II	11,0	259081
128	4000	10250	HE/TRANSP.	A	I	14,5	259043

* Initial, tolerance +/- 10%

LABO LED

OFFICE LIGHTING

SURFACE MOUNTING:

LABO LED 595x595

IP65 

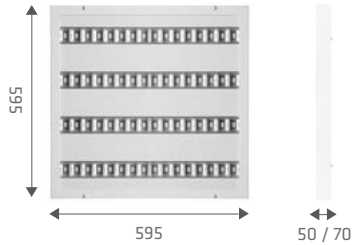

595x595x50 - dimension variant I
595x595x70 - dimension variant II

rated power [W]	colour temperature [K]	total luminous flux* [lm]	reflector/diffuser	EEl	dimension variant	weight [kg]	index
32	4000	2850	HE/TRANSP.	A	I	7,6	259159
48	4000	3850	-/OPAL	A	II	5,5	259203

LABO LED 295x1195

IP65 

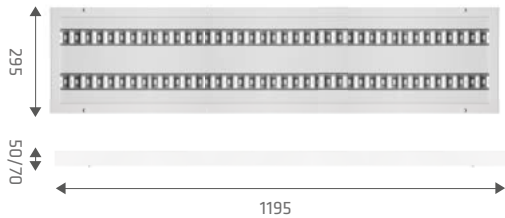

295x1195x50 - dimension variant I
295x1195x70 - dimension variant II

rated power [W]	colour temperature [K]	total luminous flux* [lm]	reflector/diffuser	EEl	dimension variant	weight [kg]	index
32	4000	2850	HE/TRANSP.	A	I	7,6	259166
48	4000	3850	-/OPAL	A	II	5,5	259210
64	4000	5100	HE/TRANSP.	A	I	8,1	259173

LABO LED 595x1195

IP65 

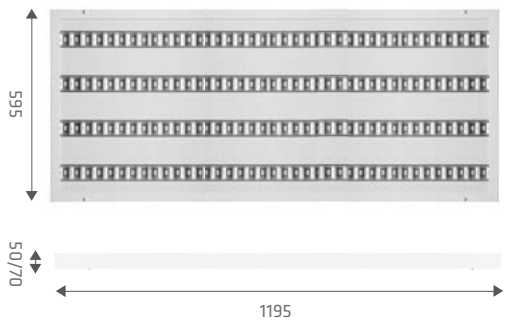

595x1195x50 - dimension variant I
595x1195x70 - dimension variant II

rated power [W]	colour temperature [K]	total luminous flux* [lm]	reflector/diffuser	EEl	dimension variant	weight [kg]	index
64	4000	5100	HE/TRANSP.	A	I	14,0	259180
96	4000	7650	-/OPAL	A	II	11,0	259234
128	4000	10250	HE/TRANSP.	A	I	14,5	259197

* Initial, tolerance +/- 10%

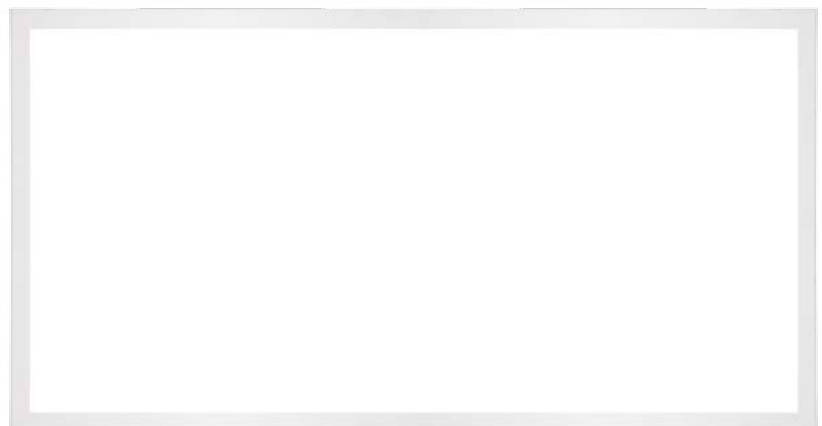



PURO LED

OFFICE LIGHTING

LED GO!



SPECIFICATION

Ingress protection class:	IP65
Total luminous flux*:	max. 3900lm (4000K)
Colour temperature (CCT):	3000K, 4000K
Energy efficiency class (EEI):	A
Power supply:	220-240V / 50-60Hz
Mounting:	surface / recessed in modular ceiling
Body:	powder coated steel
Diffuser:	PMMA OPAL, PRM

Recessed or surface mounted square LED luminaire sealed to IP65 with high lighting parameters, equipped with energy saving light sources LED GO! Optic made of low aluminium profile in grey colour combined with high uniformity prismatic or opal cover providing low glare and enabling firm connection with the body, for surface or recessed mounting in modular ceiling system, made of powder coated white steel sheet equipped with silicone gasket for high tightness. Colour temperature 3000/4000K. CRI>80, lifespan of LED 50 000h (L70B50) $t_a= 25^{\circ}\text{C}$.

LIGHT BEAM CURVES

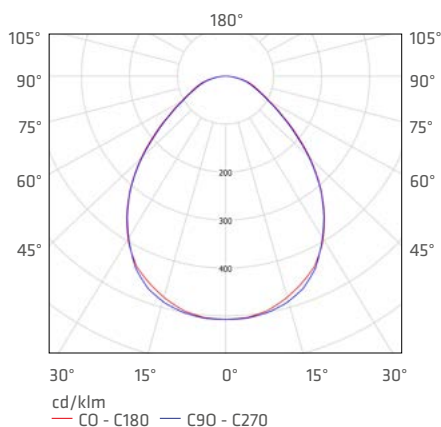

APPLICATION

Luminaire with high ingress protection IP65, equipped with high efficient, energysaving light sources LED GO!, do not containing mercury or emitting ultraviolet and infrared radiation. Luminaire specially recommended for healthcare facilities, laboratories, medical equipment manufacturing, food industry, pharmaceutical or cosmetic industry. It is appropriate for new applications as well as replacing conventional T8 & T5 fittings on energy-saving LED solutions. Designed for surface mounted and for modular ceiling 600x600.

SURFACE MOUNTING:

PURO LED



IP65 | 

8,50  KG

rated power [W]	colour temperature [K]	total luminous flux* [lm]	diffuser	EEI	index
48	3000	3600	PRM	A	521515
48	4000	3900	PRM	A	521539
48	3000	3400	OPAL	A	521478
48	4000	3700	OPAL	A	521492

RECESSED MOUNTING:

PURO LED



IP65 | 

MODULE CEILING
600/600
7,30  KG

rated power [W]	colour temperature [K]	total luminous flux* [lm]	diffuser	EEI	index
48	3000	3600	PRM	A	521522
48	4000	3900	PRM	A	521546
48	3000	3400	OPAL	A	521485
48	4000	3700	OPAL	A	521508

* Initial, tolerance +/- 10%

ACCESSORIES

index	article name
54000267	plasterboard clips (set of 4 pcs)



SWING LED

OFFICE LIGHTING

LED GO!



SPECIFICATION

Ingress protection class:	IP40
Total luminous flux:*	max. 2300lm (4000K)
Colour temperature (CCT):	3000K, 4000K
Energy efficiency class (EEI):	A
Power supply:	220-240V / 50-60Hz
Mounting:	recessed / frameless
Body:	ABS, aluminium, steel
Diffuser:	PC

Recessed frameless downlight fitting equipped with modern and energy-saving light source COB LED. The body made of plastic, steel and aluminium ensures a long-term operation of the fitting. The diffuser made of highly transparent PMMA guarantees high luminous flux and ensures optimal conditions for the LED operation. Due to the possibility of adjusting the light direction vertically up to 30° and horizontally (turn) up to 355°, four options of diffuser to choose: 65°, 25°, 59°/92°, as well as modern and elegant design, the fitting is suitable for a variety of applications.

LIGHT BEAM CURVES

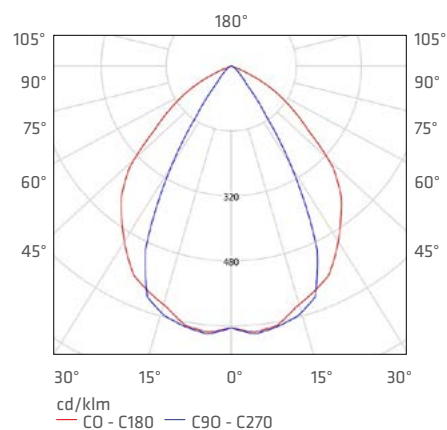

APPLICATION

Recessed fitting suitable for mounting in plasterboard ceilings, dedicated for indoor use as a basic or accent lighting. Due to modern and elegant design and the possibility of choosing the optimal light distribution, the fitting is ideal for offices, commercial buildings and passageways.

SWING LED

OFFICE LIGHTING

SWING LED 15W

IP40 

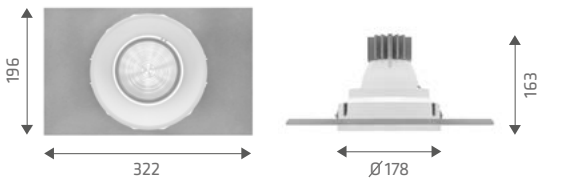

Ø 196 

1,20 

rated power [W]	colour temperature [K]	total luminous flux* [lm]	diffuser	beam angle	EEL	index
15	3000	950	MAT	25°	A	091032
15	4000	1100	MAT	25°	A	091049
15	3000	1260	PRM	65°	A	091018
15	4000	1500	PRM	65°	A	091025
15	3000	1220	PRM	59°/92°	A	091056
15	4000	1450	PRM	59°/92°	A	091063

SWING LED 20W

IP40 

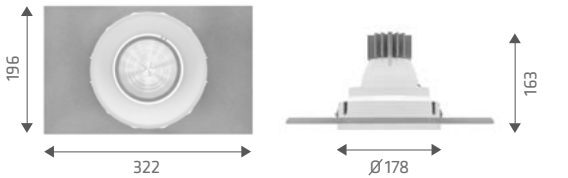

Ø 196 

1,20 

rated power [W]	colour temperature [K]	total luminous flux* [lm]	diffuser	beam angle	EEL	index
20	3000	1080	MAT	25°	A	091094
20	4000	1280	MAT	25°	A	091100
20	3000	1500	PRM	65°	A	091070
20	4000	1750	PRM	65°	A	091087
20	3000	1450	PRM	59°/92°	A	091117
20	4000	1700	PRM	59°/92°	A	091124

SWING LED 25W

IP40 

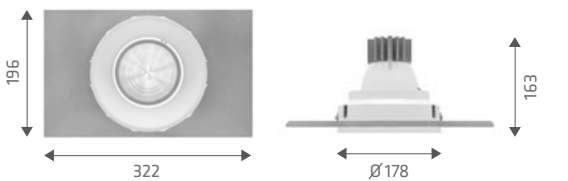

Ø 196 

1,20 

rated power [W]	colour temperature [K]	total luminous flux* [lm]	diffuser	beam angle	EEL	index
25	3000	1650	MAT	25°	A	091155
25	4000	1900	MAT	25°	A	091162
25	3000	2000	PRM	65°	A	091131
25	4000	2300	PRM	65°	A	091148
25	3000	1950	PRM	59°/92°	A	091179
25	4000	2250	PRM	59°/92°	A	091186

* Initial, tolerance +/- 10%

SWING LED

OFFICE LIGHTING



LIGHT DISTRIBUTION TYPES

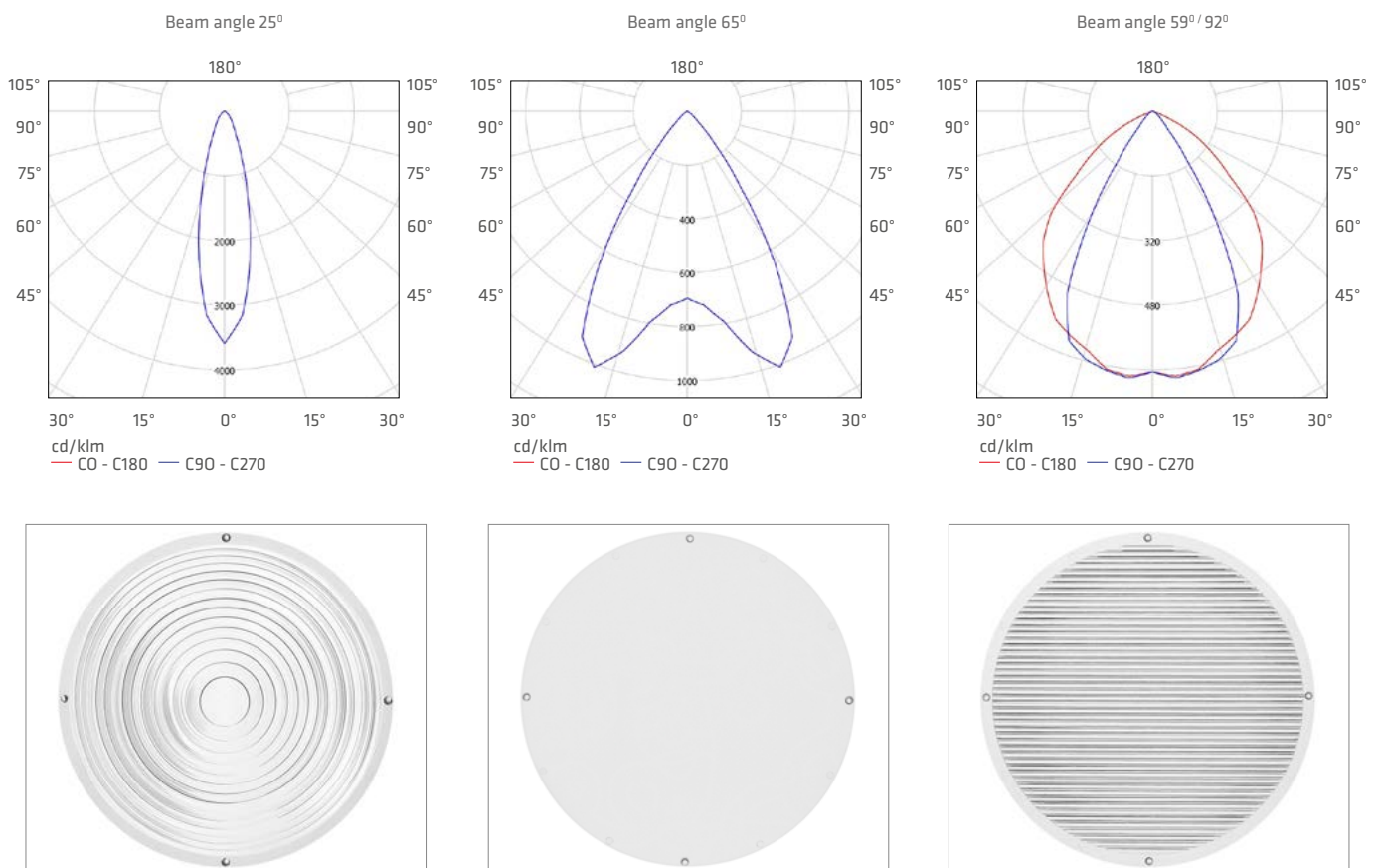



DL 220 LED

OFFICE LIGHTING

LED GO!



SPECIFICATION

Ingress protection class:	IP65
Impact resistance:	IK08
Total luminous flux:*	max. 2900lm (4000K)
Colour temperature (CCT):	3000K, 4000K
Energy efficiency class (EEI):	A
Power supply:	220-240V / 50-60Hz
Mounting:	recessed
Body:	plastic
Diffuser:	PC PRM, PRM MAT

Round LED downlight recessed mounting with light efficiency 94 lm/W, even light distribution and high ingress protection class IP65 (diffuser), IP40 (top) equipped with an integrated energy-saving light source LED GO! Body made of ABS plastic with prismatic PC diffuser. Available options with DALI/DIMM 1-10V or with emergency module. Colour temperature 3000K/4000K, CRI>80, LED life-span 50 000h (L70B50) $t_a = 25\text{ }^\circ\text{C}$.

LIGHT BEAM CURVES

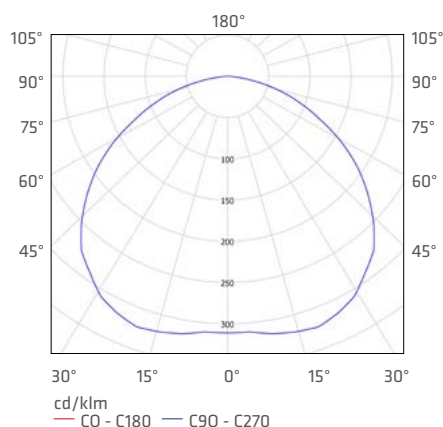

APPLICATION

Luminaire designed for both indoor (offices, routes, farm buildings) and outdoor use (IP65). Due to the possibility of making it with ballast compatible with external lighting systems, it is particularly recommended to A class office buildings. Provides good surface lighting and works well in situations that require eyesight concentration. Designed for mounting in each type of suspended ceiling (modular, plasterboard).

DL 220 LED

OFFICE LIGHTING

DL 220 LED 8W

IP65 | IK08 | 

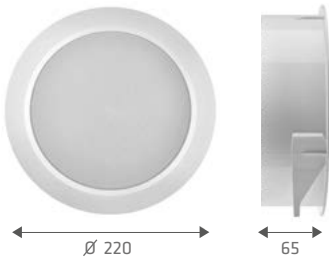

Ø 205 

0,80  KG

rated power [W]	colour temperature [K]	total luminous flux* [lm]	diffuser	EEI	index
8	3000	550	PRM	A	515026
8	4000	600	PRM	A	515088
8	3000	570	PRM MAT	A	515491
8	4000	620	PRM MAT	A	515378

DL 220 LED 12W

IP65 | IK08 | 

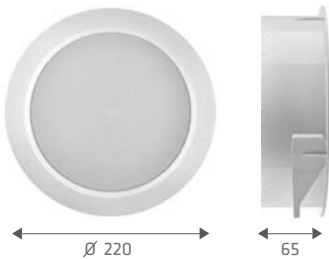

Ø 205 

0,80  KG

rated power [W]	colour temperature [K]	total luminous flux* [lm]	diffuser	EEI	index
12	3000	890	PRM	A	515033
12	4000	960	PRM	A	515095
12	3000	870	PRM MAT	A	515392
12	4000	940	PRM MAT	A	515279

DL 220 LED 18W

IP65 | IK08 | 

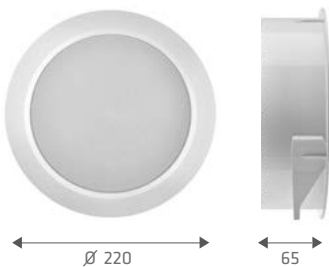

Ø 205 

0,80  KG

rated power [W]	colour temperature [K]	total luminous flux* [lm]	diffuser	EEI	index
18	3000	1150	PRM	A	515040
18	4000	1250	PRM	A	515101
18	3000	1350	PRM MAT	A	515484
18	4000	1450	PRM MAT	A	515361

DL 220 LED 24W

IP65 | IK08 | 

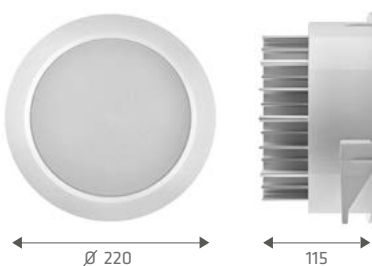

Ø 205 

1,30  KG

rated power [W]	colour temperature [K]	total luminous flux* [lm]	diffuser	EEI	index
24	3000	1950	PRM	A	515057
24	4000	2100	PRM	A	515118
24	3000	1750	PRM MAT	A	515385
24	4000	1900	PRM MAT	A	515262

DL 220 LED

OFFICE LIGHTING

DL 220 LED 32W

IP65 | IK08 | 

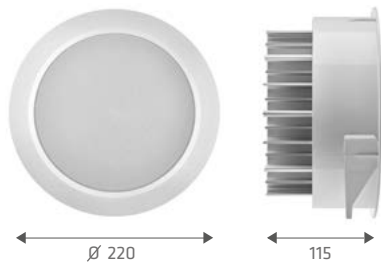

Ø 220

115

Ø 205 

1,50 

rated power [W]	colour temperature [K]	total luminous flux* [lm]	diffuser	EEl	index
32	3000	2300	PRM	A	515064
32	4000	2600	PRM	A	515125
32	3000	2300	PRM MAT	A	515507
32	4000	2500	PRM MAT	A	515514

DL 220 LED 40W

IP65 | IK08 | 

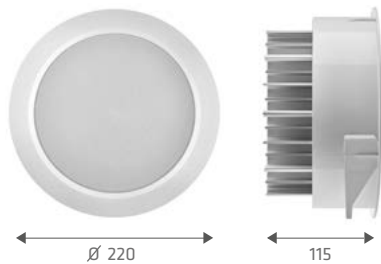

Ø 220

115

Ø 205 

1,50 

rated power [W]	colour temperature [K]	total luminous flux* [lm]	diffuser	EEl	index
40	3000	2600	PRM	A	515071
40	4000	2800	PRM	A	515132
40	3000	2700	PRM MAT	A	515521
40	4000	2900	PRM MAT	A	515538

* Initial, tolerance +/- 10%

Available options: **DIMM 1-10V, DALI, RAL 9006 colour.**

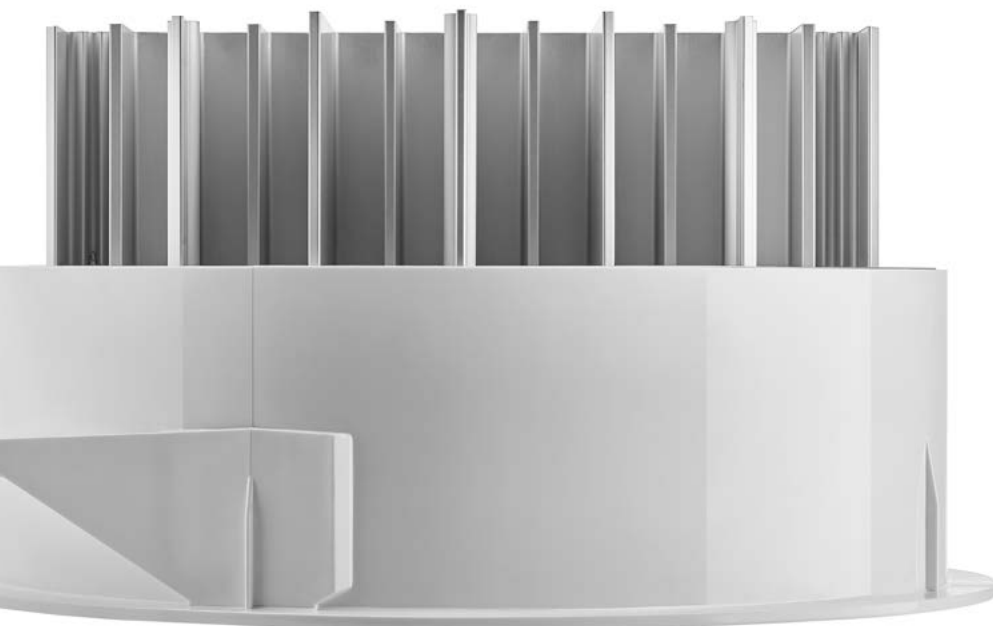



NECTRA ART LED

OFFICE LIGHTING

LED



SPECIFICATION

Ingress protection class:	IP40
Total luminous flux*:	max. 2150lm (4000K)
Colour temperature (CCT):	3000K, 4000K
Energy efficiency class (EEI):	A+, A
Power supply:	220-240V / 50-60Hz
Mounting:	recessed
Body:	PC, aluminium
Diffuser:	PC

A decorative flush-mounted LED downlight with Ingress protection class IP40, equipped with an energy-saving LED light source. Its body made of thermally conductive polycarbonate with integrated aluminium reflector ensures optimal conditions for the LED operation. The diffuser is made of highly transparent PC to guarantee high luminous flux. The luminaire is suitable for tool-free installation in plasterboard ceilings and ensures low maintenance costs. Specification: colour temperature 3000K, 4000K; CRI>80.

LIGHT BEAM CURVES

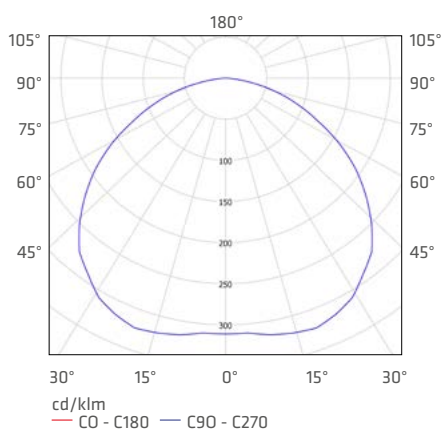

APPLICATION

The flush-mounted luminaire is intended for indoor use in offices, stores, passageways and sanitation rooms. Due to even light distribution on the surface and high decorative value, it is recommended for use in buildings with high-standard architecture.

NECTRA ART LED

OFFICE LIGHTING

NECTRA ART LED

IP40 

rated power [W]	colour temperature [K]	total luminous flux* [lm]	diffuser	EEL	index
23	3000	2000	OPAL	A	060502
23	4000	2150	OPAL	A+	060519



Ø 245



49

Ø 220 

0,65 

* Initial, tolerance +/- 10%



FRAGA LED

OFFICE LIGHTING

COB LED



SPECIFICATION

Ingress protection class:	IP40
Total luminous flux*:	max. 1150lm (4000K)
Colour temperature (CCT):	3000K, 4000K
Energy efficiency class (EEI):	A+, A
Power supply:	220-240V / 50-60Hz
Mounting:	recessed / surface (case for surface mounting available as accessory)
Body:	aluminium, PMMA
Diffuser:	PMMA transparent

A downlight luminaire with narrow, 36° wide, light distribution angle and the light beam adjustable within +/-30°. Equipped with modern and energy-efficient COB LED light source. Its body made of aluminium and PMMA ensures optimum LED operating conditions and the diffuser made of highly transparent PMMA guarantees high luminous efficiency of the luminaire. Suitable for tool-free installation in plasterboard ceilings.

LIGHT BEAM CURVES

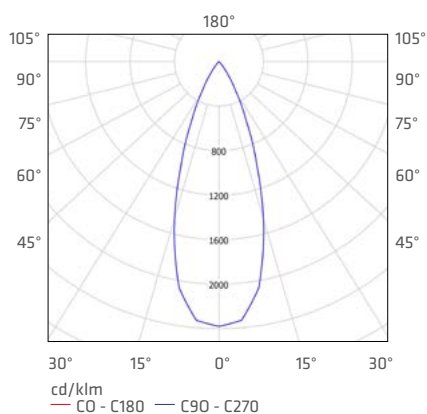

APPLICATION

Intended for indoor use in passageways and entry areas.

FRAGA LED 4W



IP40 

Ø 75 

0,16 

rated power [W]	colour temperature [K]	total luminous flux* [lm]	diffuser	EEl	index
4	3000	260	PRM	A+	059209
4	4000	270	PRM	A+	059216

FRAGA LED 6W



IP40 

Ø 75 

0,16 

rated power [W]	colour temperature [K]	total luminous flux* [lm]	diffuser	EEl	index
6	3000	360	PRM	A	059223
6	4000	400	PRM	A	059230

FRAGA LED 11W

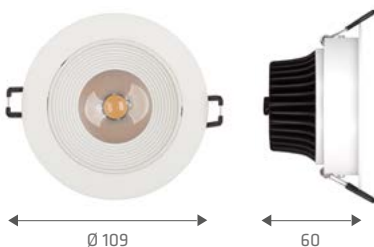

IP40 

Ø 95 

0,29 

rated power [W]	colour temperature [K]	total luminous flux* [lm]	diffuser	EEl	index
11	3000	640	PRM	A	059247
11	4000	740	PRM	A	059254

FRAGA LED 15W

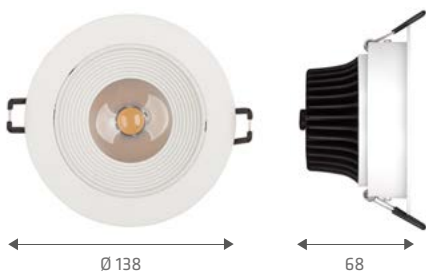

IP40 

Ø 120 

0,51 

rated power [W]	colour temperature [K]	total luminous flux* [lm]	diffuser	EEl	index
15	3000	1000	PRM	A	059261
15	4000	1150	PRM	A	059278

* Initial, tolerance +/- 10%

FRAGA LED

OFFICE LIGHTING

TECHNICAL DETAILS



Adjustable lens position

ACCESSORIES

ROUND CASE FOR SURFACE MOUNTING

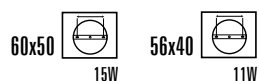

type	weight [kg]	dimensions A/B/C [mm]	index
11W	0,60	160/160/65	059841
15W	0,80	185/185/85	059858





NECTRA LED

OFFICE LIGHTING

LED



SPECIFICATION

Ingress protection class:	IP40
Impact resistance:	IK08
Total luminous flux*:	max. 1500lm (4000K)
Colour temperature (CCT):	3000K, 4000K
Energy efficiency class (EEI):	A+, A
Power supply:	220-240V / 50-60Hz
Mounting:	recessed / surface (case for surface mounting available as accessory)
Body:	aluminium
Diffuser:	PC OPAL

Downlight type fitting with an integrated energy-saving LED source. Made of lightweight aluminium and plastic. Available in two ringcolours and three power versions. Its distinctive features are low profile, light weight and very easy and fast installation.

LIGHT BEAM CURVES

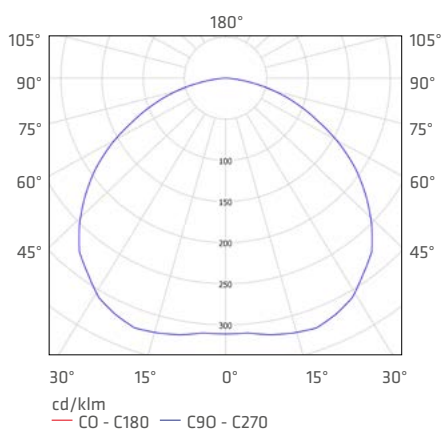

APPLICATION

Design for both solid and modular ceilings.

NECTRA LED

OFFICE LIGHTING

NECTRA LED 5W

IP40 | IK08 | 

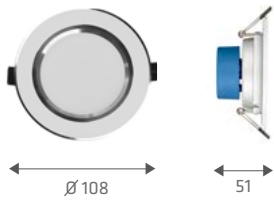

rated power [W]	colour temperature [K]	total luminous flux* [lm]	diffuser	EEL	index
5	3000	360	OPAL	A+	059520
5	4000	370	OPAL	A+	059537

NECTRA LED 7W

IP40 | IK08 | 

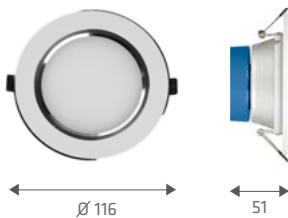

rated power [W]	colour temperature [K]	total luminous flux* [lm]	diffuser	EEL	index
7	3000	540	OPAL	A+	059551
7	4000	570	OPAL	A+	059568

NECTRA LED 9W

IP40 | IK08 | 

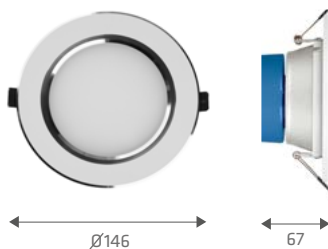

rated power [W]	colour temperature [K]	total luminous flux* [lm]	diffuser	EEL	index
9	3000	710	OPAL	A+	059582
9	4000	720	OPAL	A+	059599

NECTRA LED 12W

IP40 | IK08 | 

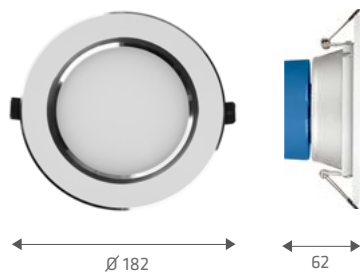

rated power [W]	colour temperature [K]	total luminous flux* [lm]	diffuser	EEL	index
12	3000	880	OPAL	A+	059605
12	4000	910	OPAL	A+	059629

* Initial, tolerance +/- 10%



NECTRA LED

OFFICE LIGHTING

NECTRA LED 15W

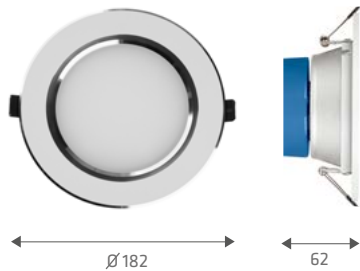
IP40 | IK08 | 





Ø 163 
0,41 

rated power [W]	colour temperature [K]	total luminous flux* [lm]	diffuser	EEl	index
15	3000	1200	OPAL	A	059643
15	4000	1250	OPAL	A	059667

NECTRA LED 18W

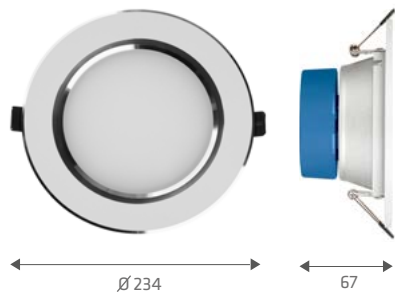
IP40 | IK08 | 



Ø 206 
0,65 



rated power [W]	colour temperature [K]	total luminous flux* [lm]	diffuser	EEl	index
18	3000	1400	OPAL	A	059681
18	4000	1500	OPAL	A	059704

* Initial, tolerance +/- 10%

ACCESSORIES

SQUARE CASE FOR SURFACE MOUNTING









120x100  18W
80x50  12W 100x70  15W

type	weight [kg]	dimensions A/B/C [mm]	index
12W	0,50	220/220/68	059780
15W	0,80	230/230/68	059728
18W	1,15	280/280/68	059742

ROUND CASE FOR SURFACE MOUNTING



120x120  18W 100x80  15W
80x60  12W 60x50  9W
56x40  7W 56x40  5W

type	weight [kg]	dimensions A/B/C [mm]	index
5W	0,60	160/160/65	059841
7W	0,60	160/160/65	059841
9W	0,80	185/185/85	059858
12W	0,60	220/220/80	059797
15W	0,90	230/230/80	059735
18W	1,20	280/280/80	059759



NECTRA LED IP44

OFFICE LIGHTING

LED



SPECIFICATION

Ingress protection class:	IP44
Total luminous flux*:	max. 2250lm (4000K)
Colour temperature (CCT):	3000K, 4000K
Energy efficiency class (EEI):	A+, A
Power supply:	220-240V / 50-60Hz
Mounting:	recessed / surface (case for surface mounting available as accessory)
Body:	PC / aluminium
Diffuser:	PMMA OPAL

Downlight type fitting with an integrated energy-saving LED source. Made of lightweight aluminium and plastic. Available in two ringcolours and three power versions. Its distinctive features are low profile, light weight and very easy and fast installation. Design for both solid and modular ceilings.

LIGHT BEAM CURVES

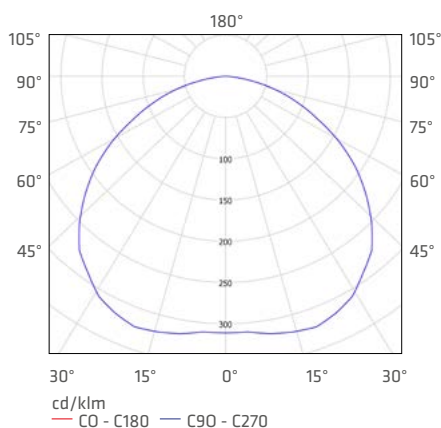

APPLICATION

Designed for indoor use in common areas, passageways or to provide additional illumination in the office rooms. Due to equal surface illumination and high energy savings, it is especially recommended for public buildings. Available in three power versions and two colour options

NECTRA LED IP44

OFFICE LIGHTING

NECTRA LED IP44 5W

IP44 

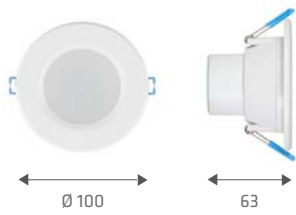

Ø 80 

0,14 

rated power [W]	colour temperature [K]	total luminous flux* [lm]	diffuser	colour	EEL	index
5	3000	400	OPAL	WHITE	A+	059902
5	4000	410	OPAL	WHITE	A+	059919

NECTRA LED IP44 9W

IP44 



Ø 100 

0,18 

rated power [W]	colour temperature [K]	total luminous flux* [lm]	diffuser	colour	EEL	index
9	3000	690	OPAL	WHITE	A+	059926
9	4000	710	OPAL	WHITE	A+	059933

NECTRA LED IP44 15W

IP44 



Ø 115 

0,33 

rated power [W]	colour temperature [K]	total luminous flux* [lm]	diffuser	colour	EEL	index
15	3000	1290	OPAL	WHITE	A	059940
15	4000	1300	OPAL	WHITE	A	059957

* Initial, tolerance +/- 10%



NECTRA LED IP44

OFFICE LIGHTING

NECTRA LED IP44 25W

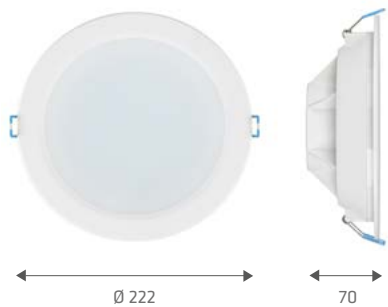
IP44 



Ø 195 
0,55 



rated power [W]	colour temperature [K]	total luminous flux* [lm]	diffuser	colour	EEL	index
25	3000	2200	OPAL	WHITE	A	059964
25	4000	2250	OPAL	WHITE	A+	059971

* Initial, tolerance +/- 10%

ACCESSORIES

SQUARE CASE FOR SURFACE MOUNTING







120x100  25W
100x70  15W

type	weight [kg]	dimensions A/B/C [mm]	index
15W	0,80	230/230/68	059728
25W	1,15	280/230/68	059742

ROUND CASE FOR SURFACE MOUNTING



120x120  25W 100x80  15W
60x50  9W 56x40  5W

typ	waga [kg]	dimensions A/B/C [mm]	index
5W	0,60	160/160/65	059841
9W	0,80	185/185/85	059858
15W	0,90	230/230/80	059735
25W	1,20	280/280/80	059759





DL 155/185 LED

OFFICE LIGHTING

LED GO!



SPECIFICATION

Ingress protection class:	IP54
Impact resistance:	IK08
Total luminous flux*:	max. 2000lm (4000K)
Colour temperature (CCT):	3000K, 4000K
Energy efficiency class (EEL):	A
Power supply:	220-240V / 50-60Hz
Mounting:	recessed
Body:	aluminium
Diffuser:	PMMA OPAL

Round LED downlight intended for recessed mounting with high luminous flux, even light distribution and high ingress protection class IP54. Includes an integrated energy-saving light source LED GO!. Die cast aluminium body, powder-coated white; opal PMMA diffuser. Colour temperature 3000K/4000K, CRI>80, lifespan of LED 50 000h (L70B50) $t_a=25^{\circ}\text{C}$.

LIGHT BEAM CURVES

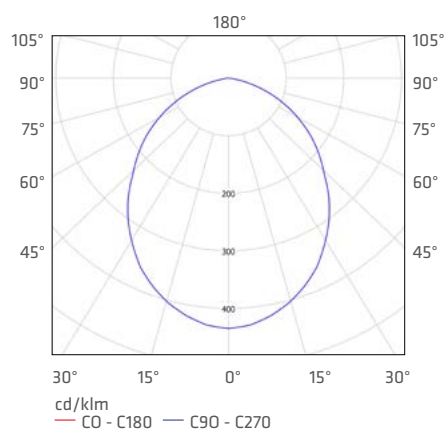

APPLICATION

Luminaire intended for both indoor (offices, passageways, utility rooms) as well as outdoor use. Provides good surface lighting and works very well in situations that require eyesight concentration. Available in two housing sizes; suited for mounting in all types of suspended ceilings (modular, plasterboard).

DL 155/185 LED

OFFICE LIGHTING

DL 155 LED

IP54 | IK08 | 

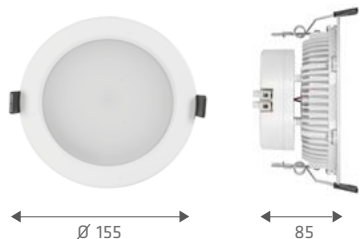

145 
0,62  KG

rated power [W]	colour temperature [K]	total luminous flux* [lm]	diffuser	EEL	index
7	3000	500	OPAL	A	057700
7	4000	560	OPAL	A	057717
14	3000	850	OPAL	A	057724
14	4000	950	OPAL	A	057731

DL 185 LED

IP54 | IK08 | 

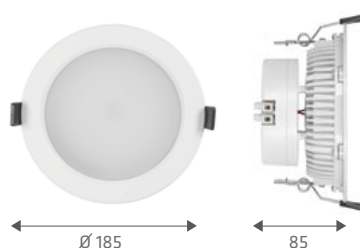

165 
0,75  KG

rated power [W]	colour temperature [K]	total luminous flux* [lm]	diffuser	EEL	index
14	3000	1100	OPAL	A	057809
14	4000	1200	OPAL	A	057816
21	3000	1800	OPAL	A	057823
21	4000	2000	OPAL	A	057830

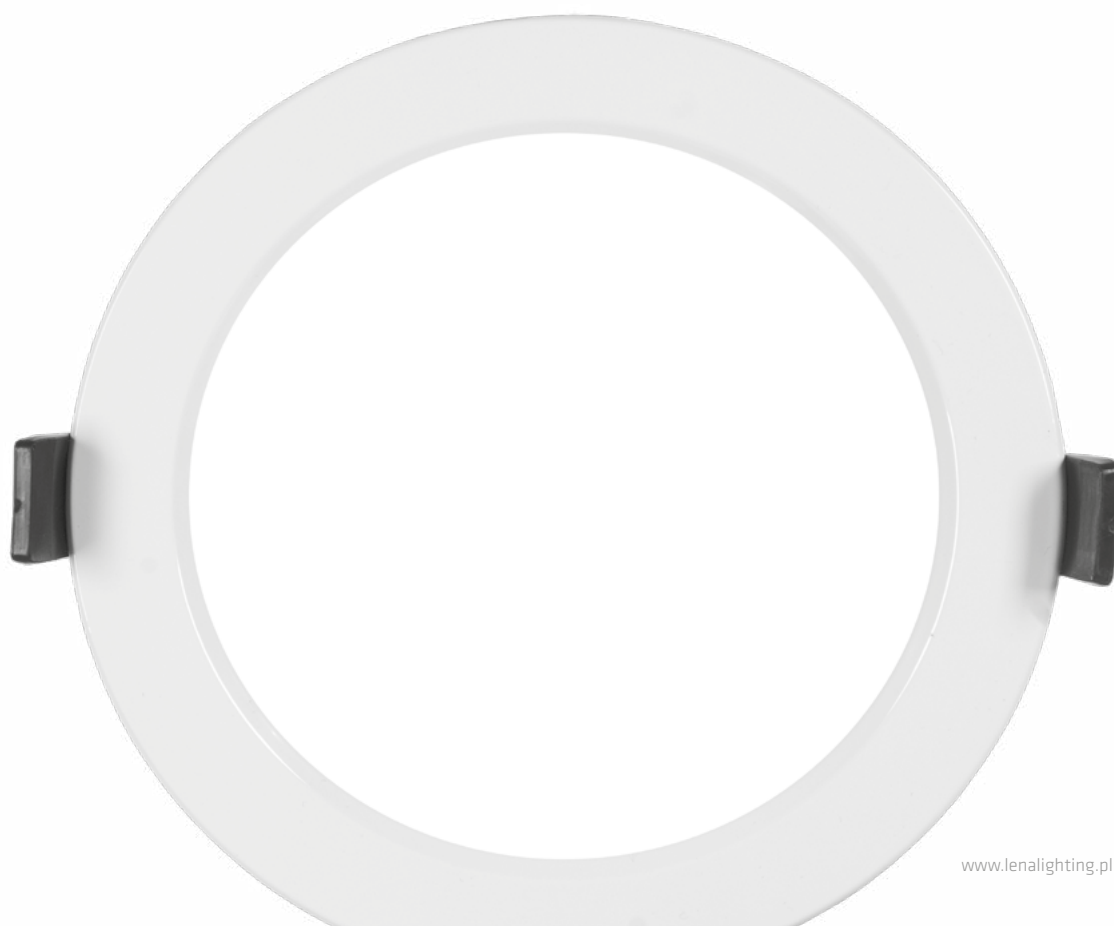

DLN 220 LED

OFFICE LIGHTING

LED GO!



SPECIFICATION

Ingress protection class:	IP65
Impact resistance:	IK08
Total luminous flux:*	max. 1450lm (4000K)
Colour temperature (CCT):	3000K, 4000K
Energy efficiency class (EEL):	A
Power supply:	220-240V / 50-60Hz
Mounting:	surface
Body:	coated steel, plastic
Diffuser:	PC PRM MAT

Surface mounted downlight with an integrated energy-saving LED GO! panel, with high ingress protection class IP65 and high impact protection class IK08. Opal diffuser made of polycarbonate ensures even light distribution. Specification: color temperature: 3000K/4000K; CRI>80; LED panels lifespan 50 000h (L70B50) for $t_a=25^{\circ}\text{C}$. DIMM DALI, LED CRI>90 options available on request.

LIGHT BEAM CURVES

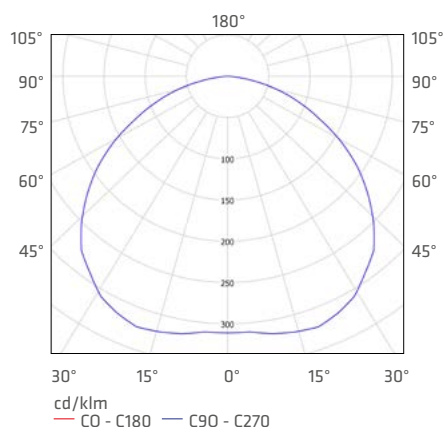

APPLICATION

The fitting is intended for surface mounting. High ingress protection class IP65 and high impact protection class IK08 make it suitable for outdoor use. Small parameters and timeless design will also prove useful in offices, passages and administrative buildings.

DLN 220 LED

OFFICE LIGHTING

DLN 220 LED 12W

IP65 | IK08 | 

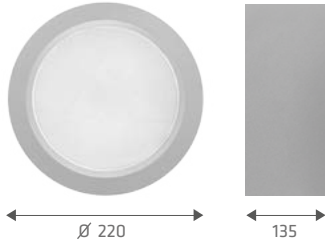

2,30  KG

rated power [W]	colour temperature [K]	total luminous flux* [lm]	diffuser	EEl	index
12	3000	870	PRM MAT	A	515897
12	4000	940	PRM MAT	A	515873

DLN 220 LED 18W

IP65 | IK08 | 

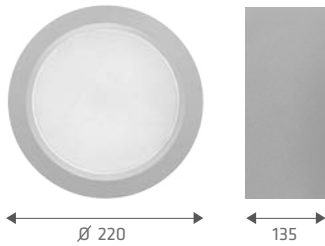

2,30  KG

rated power [W]	colour temperature [K]	total luminous flux* [lm]	diffuser	EEl	index
18	3000	1350	PRM MAT	A	515910
18	4000	1450	PRM MAT	A	515934

* Initial, tolerance +/- 10%

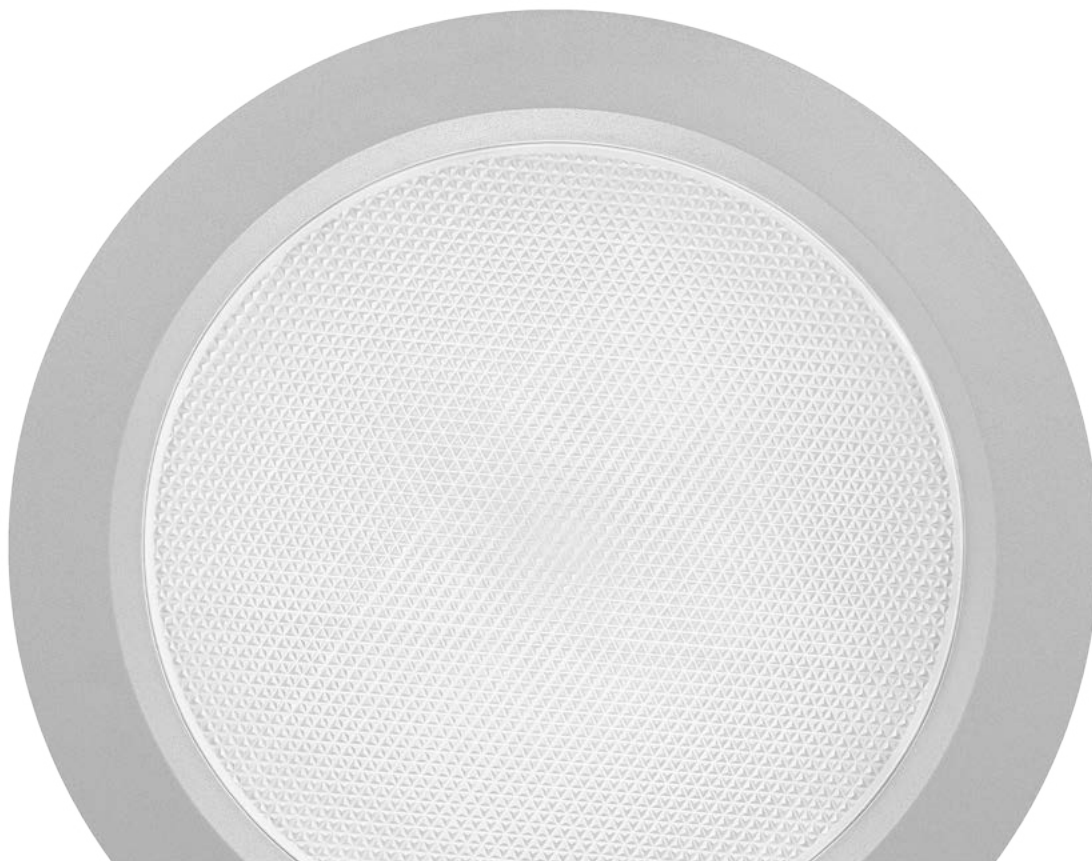

NECTRA S LED

OFFICE LIGHTING

LED



SPECIFICATION

Ingress protection class:	IP40
Total luminous flux*:	max. 2150lm (4000K)
Colour temperature (CCT):	3000K, 4000K
Energy efficiency class (EEI):	A
Power supply:	220-240V / 50-60Hz
Mounting:	surface
Body:	aluminium
Diffuser:	PMMA OPAL

Surface-mounted downlight luminaire equipped with energy-saving LED light source. Body made of white powder-coated aluminium ensures optimal conditions for the LED operation. The diffuser is made of highly transparent PMMA to guarantee high luminous flux. Specification: colour temperature 3000K, 4000K; CRI>80.

LIGHT BEAM CURVES

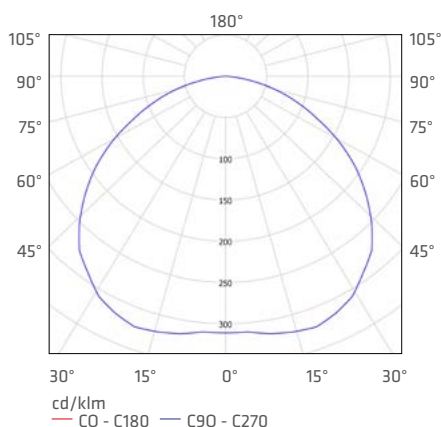

APPLICATION

The surface mounted luminaire is intended for indoor use: in offices, passageways, general utility rooms. Due to the high energy saving and even light distribution on the surface, it is recommended for use in public buildings.

NECTRA S LED

OFFICE LIGHTING

NECTRA S LED 12W

IP40 

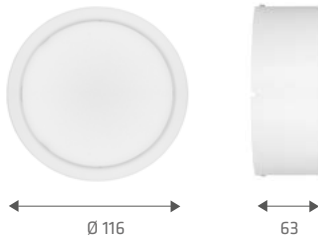

70 

0,26 

rated power [W]	colour temperature [K]	total luminous flux* [lm]	diffuser	EEl	index
12	3000	850	OPAL	A	060588
12	4000	900	OPAL	A	060595

NECTRA S LED 18W

IP40 

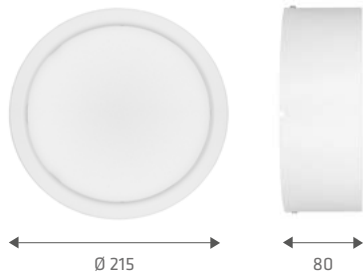

155 

0,64 

rated power [W]	colour temperature [K]	total luminous flux* [lm]	diffuser	EEl	index
18	3000	1350	OPAL	A	060601
18	4000	1450	OPAL	A	060618

NECTRA S LED 26W

IP40 

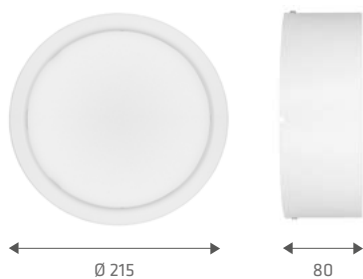

155 

0,64 

rated power [W]	colour temperature [K]	total luminous flux* [lm]	diffuser	EEl	index
26	3000	1950	OPAL	A	060625
26	4000	2100	OPAL	A	060632

* Initial, tolerance +/- 10%

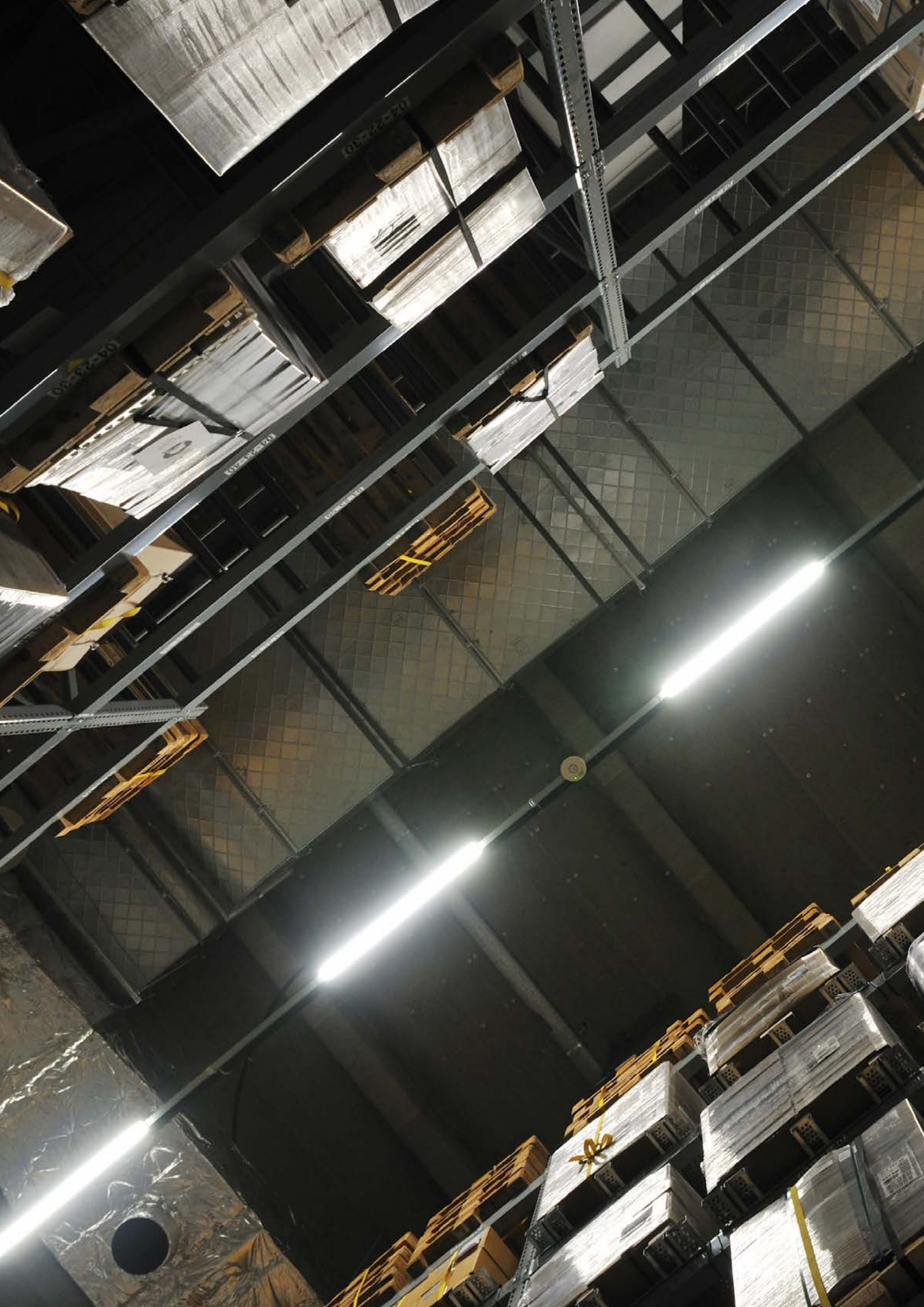



INDUSTRIAL LIGHTING & FLOODLIGHTS



CODAR RS LED EVO

Dustproof and moistureproof, surface mounted or suspended, vandal resistant, high efficiency LED luminaire with extended ingress protection class IP66. Equipped with energy saving light sources LED GO!



Meet the new CODAR! 
visit: codar.lenalighting.pl/en



LED GO! DIODES

Highly efficient LED diodes integrated with energy-saving LED GO! Lighting module available with 3000K or 4000K colour temperature, CRI>80 and lifespan of LED 50 000h (L70B50) $t_a = 25^\circ\text{C}$.

HIGH RESISTANCE AND INGRESS PROTECTION

Luminaire body made of polycarbonate with impact resistance IK09 and silicon gasket to secure IP66. INOX or PC clips available.

NEW OR MODERNISATION

Suitable for new applications as well as for replacing conventional T8 & T5 fittings with energy-saving LED solutions.

CASE STUDY

MODERNIZE AND SAVE 66% OF ENERGY THANKS TO CODAR RS LED EVO

The Investor has built a new 19,000m² production facility. As in the production facility precision assembly was to take place, a lighting system resulting in 500lx at the work surface was needed.

On the other hand, the facility was to be used 24h a day, so the most important criterion of choosing the fitting was energy-saving aspect, followed by infallibility, as each production downtime meant additional unnecessary costs.

The initial project utilised 2x58W, IP 65, luminous tube fittings. Having in mind the key assumptions, we have suggested a change from traditional fittings to 60W CODAR RS LED EVO.

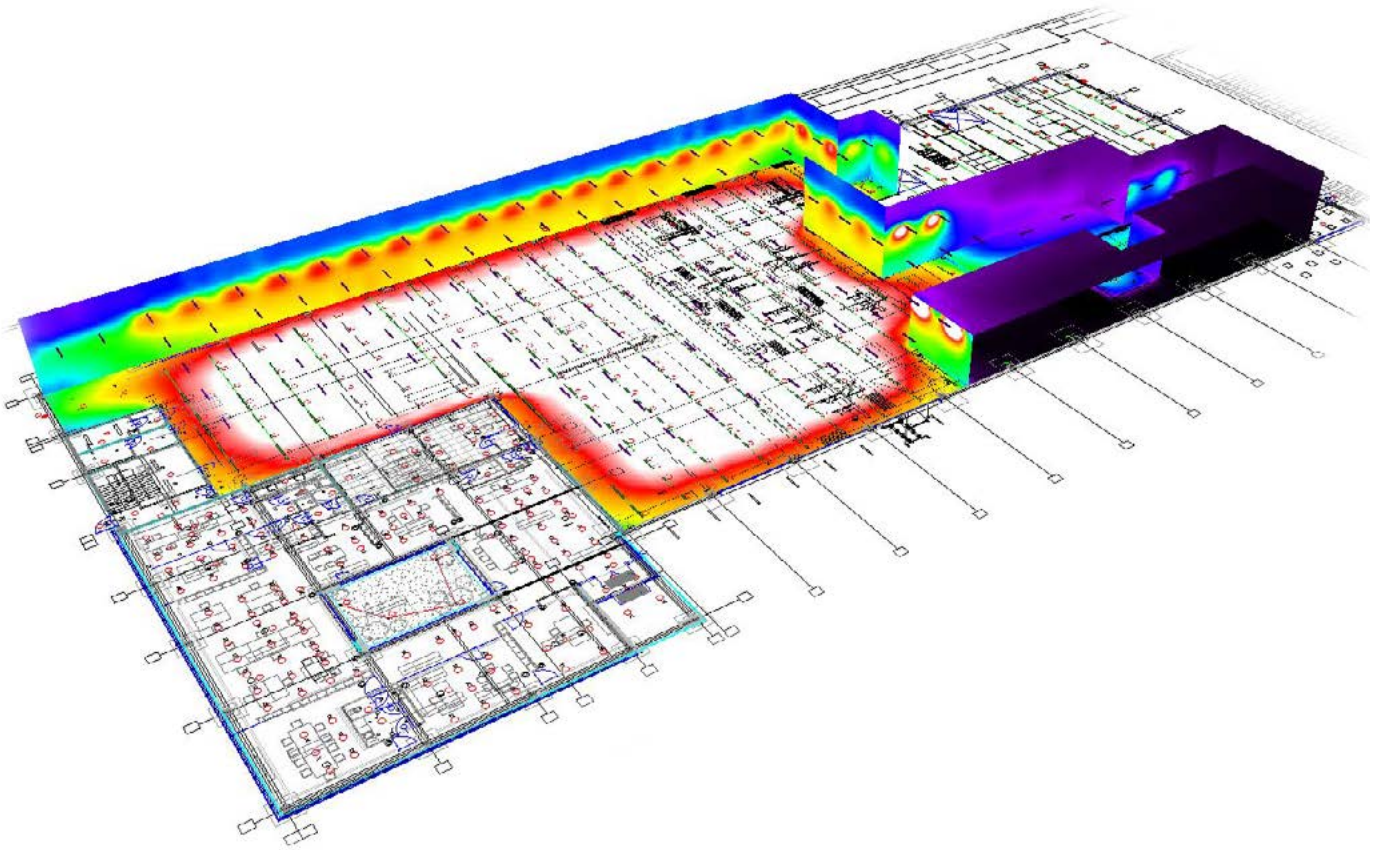

WARIANT A - EVG

- DUSTPROOF AND MOISTURE PROOF LUMINAIRE IP65
2x58W EVG x 212 psc

WARIANT B - LED

- DUSTPROOF AND MOISTURE PROOF LUMINAIRE IP66
CODAR RS LED EVO 60W x 137 psc

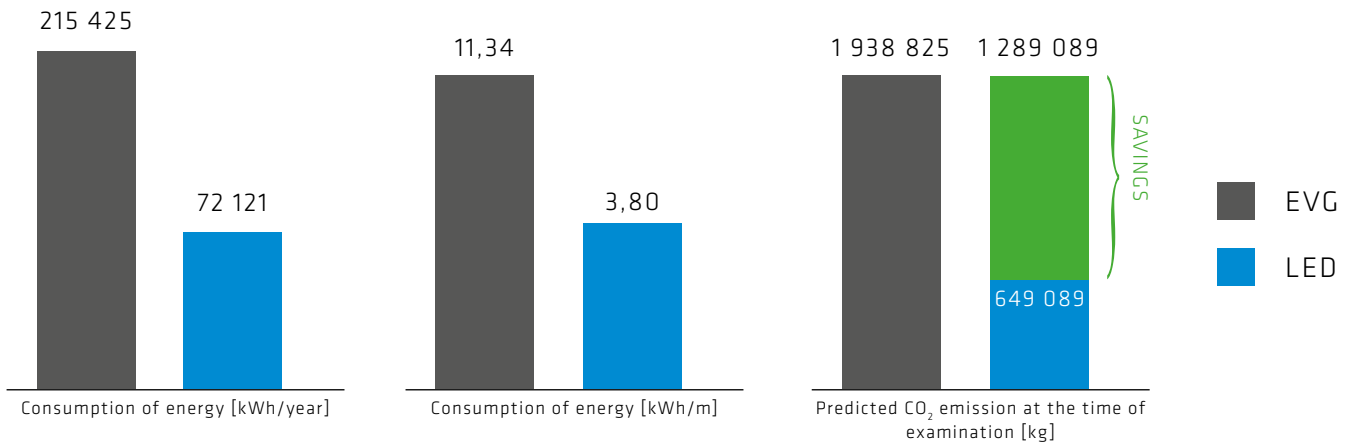

AMORTISATION OF COSTS

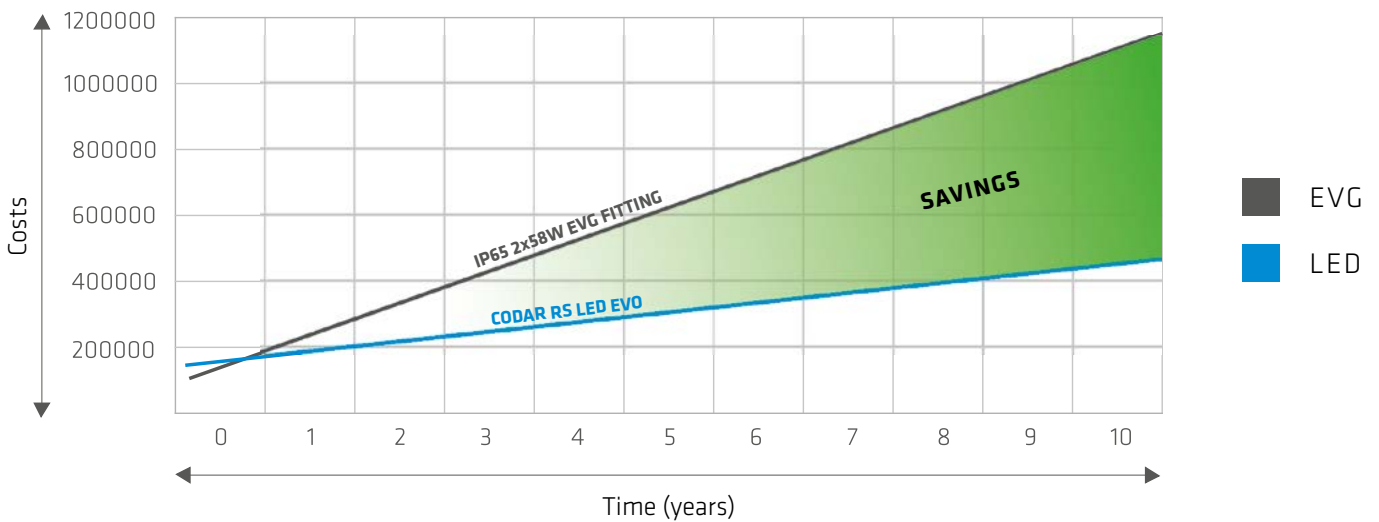

Comparative analysis proved that LED fittings are a more profitable solution in many ways. According to the design, 35% fittings less were mounted (137 pcs. of CODAR RS LED EVO 60W versus 212 pcs. of 2x58W, IP65), thus making the cost of the installation made with CODAR RS LED EVO fitting considerably smaller.

Moreover, CODAR RS LED EVO proved to be less expensive in operation due to 66% lower electrical energy usage and minimising the cost of maintenance (e.g. replacing the luminous tubes). LED GO! matrices used in the proposed solution are known for their durability.



While CODAR RS LED EVO is a little bit more expensive than the luminous tube fitting, the margin shall balance by the lower cost of electrical energy within less than 6 months. After that period, the Investor shall feel a constant, dynamic rise gains from using LED fitting system.

THE BASIC ASSUMPTION OF CASE STUDY:

Lighting time 24 hours a day; calculation period 10 years; price for 1 kWh - 0,12 EUR - constant for the whole calculation period; the cost of replacing the light sources on the basis of average market prices; the frequency of replacement lamps - in accordance with the declared lifespan.

CODAR RS LED EVO

INDUSTRIAL LIGHTING

LED GO!



SPECIFICATION

Ingress protection class:	IP66
Impact resistance:	IK09
Total luminous flux*:	max. 10250lm (4000K)
Colour temperature (CCT):	3000K, 4000K
Energy efficiency class (EEI):	A+
Power supply:	220-240V / 50-60Hz
Mounting:	surface / suspended
Body:	PC
Diffuser:	PC MAT

Dustproof and moistureproof, surface mounted or suspended, vandal resistant, high efficiency (130 lm/W) LED luminaire with extended tightness IP66. Equipped with energy saving light sources LED GO! Body made of polycarbonate with silicon gasket and special multilayer diffuser combining high impact resistant, UV stabilized prismatic polycarbonate cover. CRI>80, lifespan of LED 50 000h (L70B50) $t_a = 25^\circ\text{C}$.

LIGHT BEAM CURVES

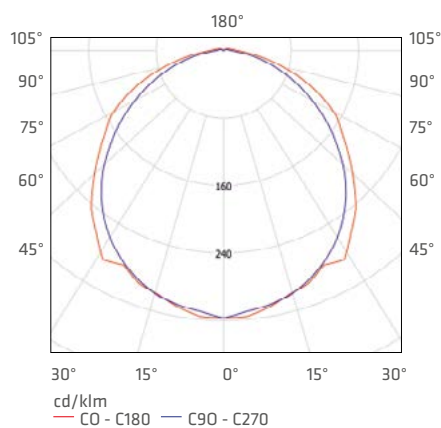

APPLICATION

Multi-purpose LED fixture designed for use in areas with high levels of dust and moisture. Especially recommended for parking (including underground and multi-level), sports stadiums, warehouses, transport terminals, subways, factories. Suitable for new applications as well as for replacing conventional T8 & T5 fittings with energy-saving LED solutions. Construction of the fitting dedicated for non-invasive surface or suspended mounting using included accessory installation kit.

CODAR RS LED EVO

INDUSTRIAL LIGHTING

CODAR RS LED EVO 16W

IP66 | IK09 | 





1,0  0,95 
RCR

rated power [W]	colour temperature [K]	total luminous flux* [lm]	diffuser	EEL	clips	sensor	index
16	3000	2000	MAT	A+	PC	-	357763
16	4000	2200	MAT	A+	PC	-	357756
16	3000	2000	MAT	A+	INOX	-	357831
16	4000	2200	MAT	A+	INOX	-	357848

CODAR RS LED EVO 30W

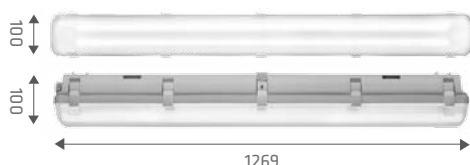
IP66 | IK09 | 



2,20  2,10 
RCR

rated power [W]	colour temperature [K]	total luminous flux* [lm]	diffuser	EEL	clips	sensor	index
30	3000	3500	MAT	A+	PC	-	339653
30	4000	3800	MAT	A+	PC	-	339660
30	3000	3500	MAT	A+	INOX	-	339677
30	4000	3800	MAT	A+	INOX	-	339684
30	3000	3500	MAT	A+	PC	RCR	339912
30	4000	3800	MAT	A+	PC	RCR	339936
30	3000	3500	MAT	A+	INOX	RCR	339929
30	4000	3800	MAT	A+	INOX	RCR	339950

CODAR RS LED EVO 32W

IP66 | IK09 | 





1,0  0,95 
RCR

rated power [W]	colour temperature [K]	total luminous flux* [lm]	diffuser	EEL	clips	sensor	index
32	3000	3600	MAT	A+	PC	-	357480
32	4000	3900	MAT	A+	PC	-	357497
32	3000	3600	MAT	A+	INOX	-	357503
32	4000	3900	MAT	A+	INOX	-	357510
32	3000	3600	MAT	A+	PC	RCR	357565
32	4000	3900	MAT	A+	PC	RCR	357589
32	3000	3600	MAT	A+	INOX	RCR	357572
32	4000	3900	MAT	A+	INOX	RCR	357602

CODAR RS LED EVO 40W

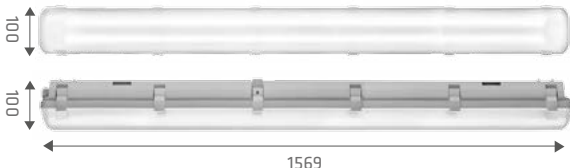
IP66 | IK09 | 



2,25  2,20 
RCR

rated power [W]	colour temperature [K]	total luminous flux* [lm]	diffuser	EEL	clips	sensor	index
40	3000	4750	MAT	A+	PC	-	357244
40	4000	5200	MAT	A+	PC	-	357251
40	3000	4750	MAT	A+	INOX	-	357268
40	4000	5200	MAT	A+	INOX	-	357275
40	3000	4750	MAT	A+	PC	RCR	357442
40	4000	5200	MAT	A+	PC	RCR	357466
40	3000	4750	MAT	A+	INOX	RCR	357459
40	4000	5200	MAT	A+	INOX	RCR	357473

CODAR RS LED EVO

INDUSTRIAL LIGHTING

CODAR RS LED EVO 50W

IP66 | IK09 | 

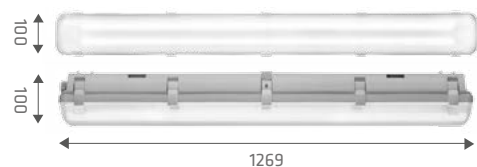



2,10  KG

rated power [W]	colour temperature [K]	total luminous flux* [lm]	diffuser	EEl	clips	sensor	index
50	3000	6500	MAT	A+	PC	-	334917
50	4000	7000	MAT	A+	PC	-	339998
50	3000	6500	MAT	A+	INOX	-	334931
50	4000	7000	MAT	A+	INOX	-	340987
50	3000	6500	MAT	A+	PC	RCR	346828
50	4000	7000	MAT	A+	PC	RCR	346835
50	3000	6500	MAT	A+	INOX	RCR	346811
50	4000	7000	MAT	A+	INOX	RCR	346842

CODAR RS LED EVO 53W

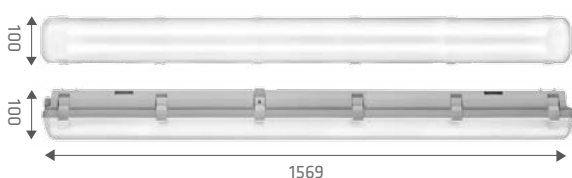
IP66 | IK09 | 



2,30  KG RCR 2,25  KG

rated power [W]	colour temperature [K]	total luminous flux* [lm]	diffuser	EEl	clips	sensor	index
53	3000	6550	MAT	A+	PC	-	357770
53	4000	7100	MAT	A+	PC	-	357794
53	3000	6550	MAT	A+	INOX	-	357787
53	4000	7100	MAT	A+	INOX	-	357800
53	3000	6550	MAT	A+	PC	RCR	346859
53	4000	7100	MAT	A+	PC	RCR	346873
53	3000	6550	MAT	A+	INOX	RCR	346866
53	4000	7100	MAT	A+	INOX	RCR	346880

CODAR RS LED EVO 60W

IP66 | IK09 | 

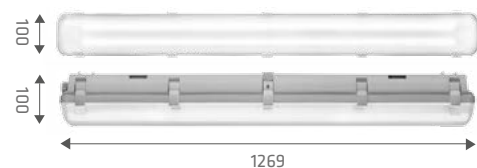

2,20  KG RCR 2,10  KG

rated power [W]	colour temperature [K]	total luminous flux* [lm]	diffuser	EEl	clips	sensor	index
60	3000	7500	MAT	A+	PC	-	339011
60	4000	8150	MAT	A+	PC	-	339028
60	3000	7500	MAT	A+	INOX	-	339202
60	4000	8150	MAT	A+	INOX	-	339233
60	3000	7500	MAT	A+	PC	RCR	339424
60	4000	8150	MAT	A+	PC	RCR	339431
60	3000	7500	MAT	A+	INOX	RCR	339448
60	4000	8150	MAT	A+	INOX	RCR	339455

* Initial, tolerance +/- 10%



CODAR RS LED EVO

INDUSTRIAL LIGHTING

CODAR RS LED EVO 77W

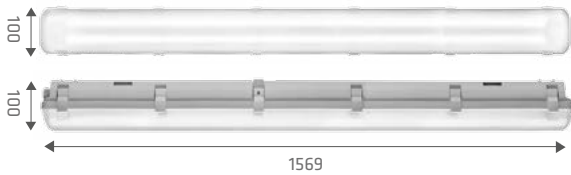
IP66 | IK09 | 



2,30  KG  KG
RCR

rated power [W]	colour temperature [K]	total luminous flux* [lm]	diffuser	EEL	clips	sensor	index
77	3000	9450	MAT	A+	PC	-	357008
77	4000	10250	MAT	A+	PC	-	357015
77	3000	9450	MAT	A+	INOX	-	357022
77	4000	10250	MAT	A+	INOX	-	357039
77	3000	9450	MAT	A+	PC	RCR	357206
77	4000	10250	MAT	A+	PC	RCR	357220
77	3000	9450	MAT	A+	INOX	RCR	357213
77	4000	10250	MAT	A+	INOX	RCR	357237

* Initial, tolerance +/- 10%

Available options: **LS2** (through-wiring), **Rapid-A**, **Rapid-A LS2**, **DALI**.

TECHNICAL DETAILS

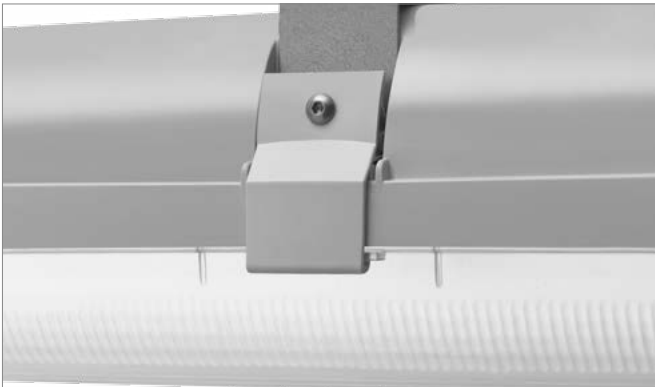

Anti-theft protection (standard).



INOX clips (option)



Rapid-A connection (option)

CODAR RS PREVALED

INDUSTRIAL LIGHTING

LED GO!

5^{Year}
OSRAM
Guarantee*



SPECIFICATION

Ingress protection class:	IP66
Impact resistance:	IK09
Total luminous flux:	max. 6950lm (4000K)
Colour temperature (CCT):	4000K
Energy efficiency class (EEI):	A+
Power supply:	220-240V / 50-60Hz
Mounting:	surface (N) suspended (Z)
Body:	PC
Diffuser:	PC MAT

Dustproof and moistureproof, surface mounted or suspended, vandal resistant, high efficiency LED luminaire with extended tightness IP66. Equipped with energy saving light sources PrevaLED (OSRAM) Body made of polycarbonate with silicon gasket and special multilayer diffuser combining high impact resistant, UV stabilized prismatic polycarbonate cover. 4000K colour temperature, CRI>80, led lifespan of 50.000h (L70B50) $t_p = 55^\circ\text{C}$.

LIGHT BEAM CURVES

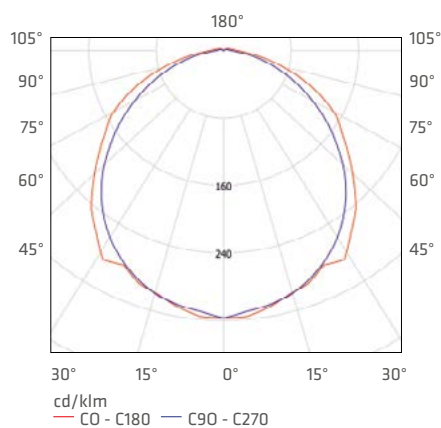

APPLICATION

Multi-purpose LED fixture designed for use in areas with high levels of dust and moisture. Especially recommended for parking (including underground and multi-level), sports stadiums, warehouses, transport terminals, subways, factories. Suitable for new applications as well as for replacing conventional T8 & T5 fittings with energy-saving LED solutions. Construction of the fitting dedicated for non-invasive surface or suspended mounting using included accessory installation kit.

CODAR RS PREVALED

INDUSTRIAL LIGHTING

CODAR RS PREVALED 34W IP66 IK09



power [W]	colour temperature [K]	total luminous flux [lm]	diffuser	EEL	clips	index
34	4000	4350	MAT	A+	INOX	380303

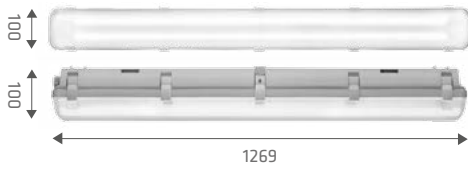

2,10 KG

CODAR RS PREVALED 43W IP66 IK09



power [W]	colour temperature [K]	total luminous flux [lm]	diffuser	EEL	clips	index
43	4000	5600	MAT	A+	INOX	380310

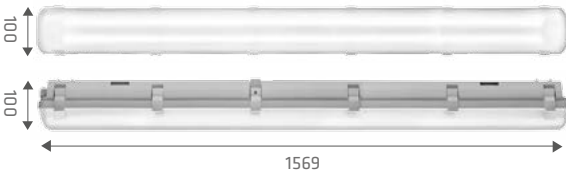

2,20 KG

CODAR RS PREVALED 48W IP66 IK09



power [W]	colour temperature [K]	total luminous flux [lm]	diffuser	EEL	clips	index
48	4000	5500	MAT	A+	INOX	380327

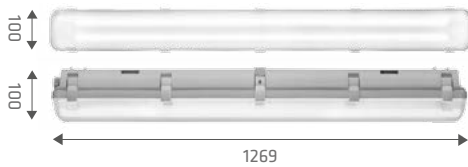

2,10 KG

CODAR RS PREVALED 60W IP66 IK09



power [W]	colour temperature [K]	total luminous flux [lm]	diffuser	EEL	clips	index
60	4000	6950	MAT	A+	INOX	380334

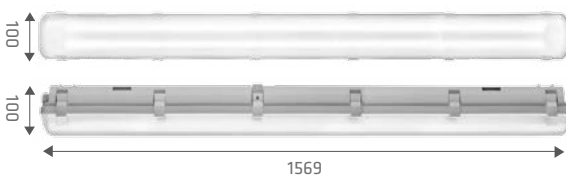

2,20 KG

CODAR RS LED EVO ENDURA

INDUSTRIAL LIGHTING

LED GO!



-30°C



+55°C



SPECIFICATION

Ingress protection class:	IP66
Impact resistance:	IK09
Total luminous flux*:	max. 9650lm (4000K)
Colour temperature (CCT):	4000K
Energy efficiency class (EEI):	A++, A+
Power supply:	220-240V / 50-60Hz
Mounting:	surface / suspended
Working temperature:	-35°C / +55°C
Body:	PC
Diffuser:	PC MAT

CODAR RS LED EVO ENDURA is a modern, energy-saving fitting with high ingress protection class IP66 and high impact protection class IK09. New Led Go! modules with innovative configuration of connections allow better heat distribution, which increases LEDs' lifespan. Innovative distribution of the fitting's components also ensures even heat distribution, better temperature control and longer lifespan of LED GO! panels. The fitting is made of especially chosen, highest quality materials. A multilayer diffuser is made of UV resistant polycarbonate. Specification: color temperature 4000K; CRI>80; LED panels lifespan 50 000h (L70B50) for $t_a=25^\circ\text{C}$

LIGHT BEAM CURVES

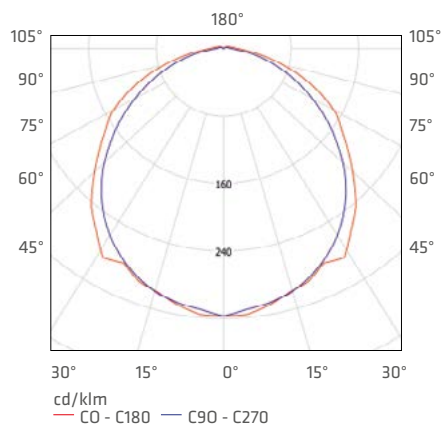

APPLICATION

CODAR RS LED EVO ENDURA is intended for use in particularly difficult conditions. Version ENDURA PLUS is dedicated for rooms with high temperature, even +55°C, eg. for industrial plants or bakeries. CODAR RS LED EVO ENDURA MINUS, in turn, will do well in rooms with low temperatures, eg. in cold stores.

CODAR RS LED EVO ENDURA

INDUSTRIAL LIGHTING

CODAR RS LED EVO ENDURA PLUS (-30°C TO +55°C)

CODAR RS LED EVO
ENDURA PLUS 28W

IP66 | IK09 | 

rated power [W]	colour temperature [K]	total luminous flux* [lm]	diffuser	EEl	clips	index
28	4000	4400	MAT	A++	INOX	334320

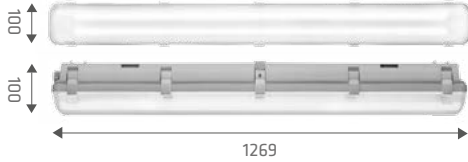

2,20  KG

CODAR RS LED EVO
ENDURA PLUS 35W

IP66 | IK09 | 

rated power [W]	colour temperature [K]	total luminous flux* [lm]	diffuser	EEl	clips	index
35	4000	5550	MAT	A++	INOX	334351

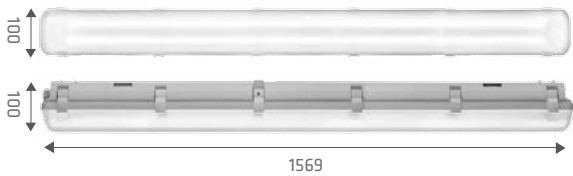

2,30  KG

CODAR RS LED EVO ENDURA MINUS (-35°C TO +35°C)

CODAR RS LED EVO
ENDURA MINUS 60W

IP66 | IK09 | 

rated power [W]	colour temperature [K]	total luminous flux* [lm]	diffuser	EEl	clips	index
60	4000	8250	MAT	A+	INOX	334368

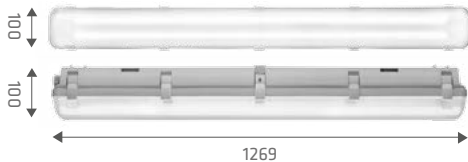

2,20  KG

CODAR RS LED EVO
ENDURA MINUS 77W

IP66 | IK09 | 

rated power [W]	colour temperature [K]	total luminous flux* [lm]	diffuser	EEl	clips	index
77	4000	9650	MAT	A+	INOX	334375

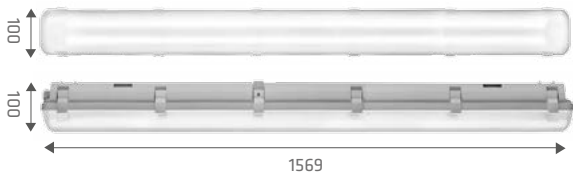

2,30  KG

* Initial, tolerance +/- 10%



Rapid-D connection (standard).

CODAR RS LED EVO HALL

INDUSTRIAL LIGHTING

LED GO!

narrow
beam

-25°C



SPECIFICATION

Ingress protection class:	IP66
Impact resistance:	IK09
Total luminous flux*:	max. 8850lm (4000K)
Colour temperature (CCT):	3000K, 4000K
Energy efficiency class (EEI):	A+ / A++
Power supply:	220-240V / 50-60Hz
Mounting:	surface / suspended
Body:	PC
Diffuser:	PC MAT
Optical system:	PMMA linear lens

Dustproof and moistureproof, surface mounted or suspended, vandal resistant, high efficiency LED luminaire with extended tightness IP66. Equipped with energy saving light sources LED GO! Body made of polycarbonate with special multilayer diffuser combining high impact resistant, UV stabilized prismatic polycarbonate cover. 3000K/4000K colour temperature, CRI>80, lifespan of LED 50 000h (L70B50) $t_a = 25^\circ\text{C}$. Narrow beam.

LIGHT BEAM CURVES

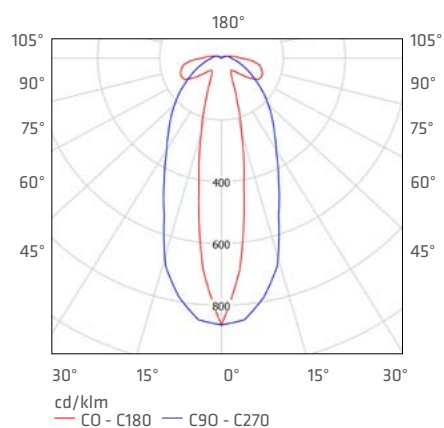

APPLICATION

Multi-purpose LED fixture designed for use in areas with high levels of dust and moisture.

CODAR RS LED EVO HALL

INDUSTRIAL LIGHTING

CODAR RS LED EVO HALL

IP66 | IK09 | 

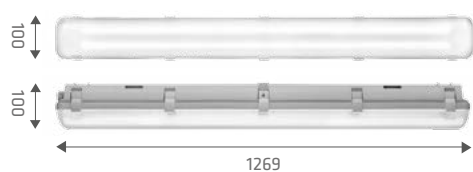

2,10  KG

rated power [W]	colour temperature [K]	total luminous flux* [lm]	diffuser	kąt rozsytu	EEL	clips	index
60	3000	6700	MAT	20°/50°	A+	PC	338984
60	4000	7250	MAT	20°/50°	A+	PC	338991
60	3000	6700	MAT	20°/50°	A+	INOX	339523
60	4000	7250	MAT	20°/50°	A+	INOX	339479

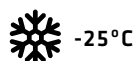

-25°C

CODAR RS LED EVO HALL

IP66 | IK09 | 



2,10  KG

rated power [W]	colour temperature [K]	total luminous flux* [lm]	diffuser	kąt rozsytu	EEL	clips	index
60	4000	8850	MAT	55°/115°	A++	INOX	346804

* Initial, tolerance +/- 10%

TECHNICAL DETAILS



INOX clips (option)



Rapid-A connection (option)

TUBE LED EVO

INDUSTRIAL LIGHTING

LED GO!

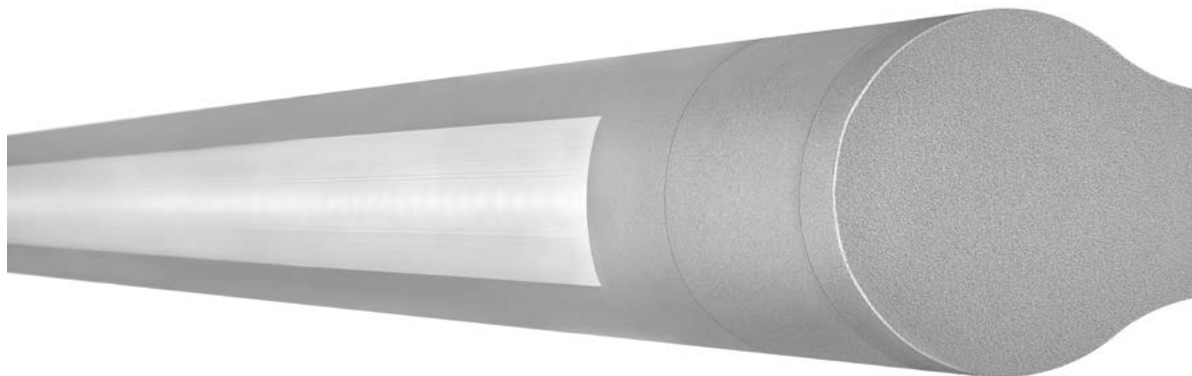

SPECIFICATION

Ingress protection class:	IP65
Impact resistance:	IK08
Total luminous flux*:	max. 3950lm (4000K)
Colour temperature (CCT):	4000K
Energy efficiency class (EEI):	A+, A
Power supply:	220-240V / 50-60Hz
Mounting:	surface / suspended
Body:	PC
Diffuser:	PC OPAL

LED luminaire system designed for suspended and surface mounting on walls and ceilings. Provides a combination of high illumination parameters and functionality. With its slim diameter of 42 mm possible to mount in hard-to-reach locations. Easy and quick installation thanks to easy access to terminal block and mounting hole after removing the end cap. Due to the line lens, it is possible to adjust the fitting to different lighting requirements - three light distribution options: 90°, 60°, 30°. Colour temperature 3000K/4000K, CRI>80, lifespan of LED 50 000h (L70B50) $t_a = 25^\circ\text{C}$.

LIGHT BEAM CURVES

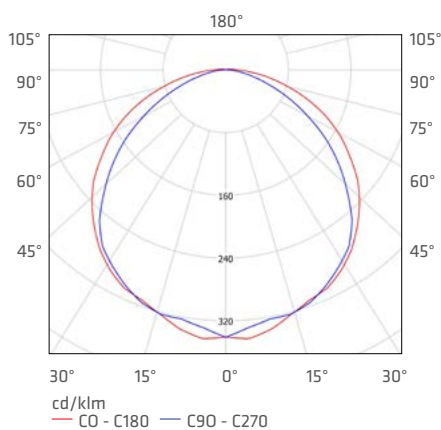

APPLICATION

Luminaire intended for both outdoor and indoor use in industry areas and passageways. Provides good surface lighting and is perfect in situations that require eyesight concentration. Four housing sizes available. Suitable for mounting in all types of suspended ceilings (modular, plasterboard).

TUBE LED EVO 14W

IP65 | IK08 | 

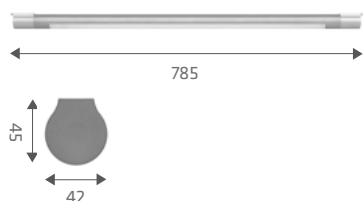

0,80 

rated power [W]	colour temperature [K]	total luminous flux* [lm]	beam angle	RAPID	EEl	index
14	4000	1250	30°	LS1	A	267246
14	4000	1250	30°	LS2	A	267277
14	4000	1600	60°	LS2	A+	267253
14	4000	1600	60°	LS2	A+	267284
14	4000	1500	90°	LS1	A	267260
14	4000	1500	90°	LS2	A	267291

TUBE LED EVO 21W

IP65 | IK08 | 

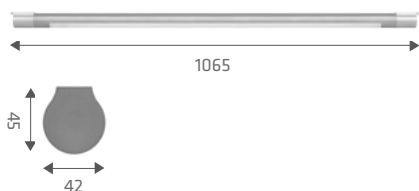

1,00 

rated power [W]	colour temperature [K]	total luminous flux* [lm]	beam angle	RAPID	EEl	index
21	4000	1900	30°	LS1	A	267338
21	4000	1900	30°	LS2	A	267369
21	4000	2350	60°	LS2	A+	267345
21	4000	2350	60°	LS2	A+	267376
21	4000	2200	90°	LS1	A	267352
21	4000	2200	90°	LS2	A	267383

TUBE LED EVO 28W

IP65 | IK08 | 

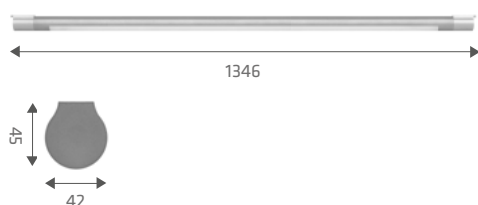

1,20 

rated power [W]	colour temperature [K]	total luminous flux* [lm]	beam angle	RAPID	EEl	index
28	4000	2500	30°	LS1	A	267420
28	4000	2500	30°	LS2	A	267451
28	4000	3100	60°	LS2	A+	267437
28	4000	3100	60°	LS2	A+	267468
28	4000	2900	90°	LS1	A	267444
28	4000	2900	90°	LS2	A	267475

TUBE LED EVO 36W

IP65 | IK08 | 



1,50 

rated power [W]	colour temperature [K]	total luminous flux* [lm]	beam angle	RAPID	EEl	index
36	4000	3150	30°	LS1	A	267512
36	4000	3150	30°	LS2	A	267543
36	4000	3950	60°	LS2	A+	267529
36	4000	3950	60°	LS2	A+	267550
36	4000	3700	90°	LS1	A	267536
36	4000	3700	90°	LS2	A	267567

* Initial, tolerance +/- 10%
LS1 (1-side), LS2 (2-side, through-wiring)

TUBE LED EVO

INDUSTRIAL LIGHTING

ACCESSORIES

index	article name
266591	Tube LED electrical cord (IP20)
266829	Tube LED suspension cord (round box)
266607	Tube LED suspension cord
267604	Bracket for surface mounting - adjustment +/-100°



266591



266829



266607

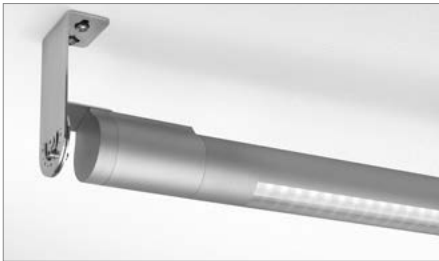

267604

LIGHT BEAM CURVES

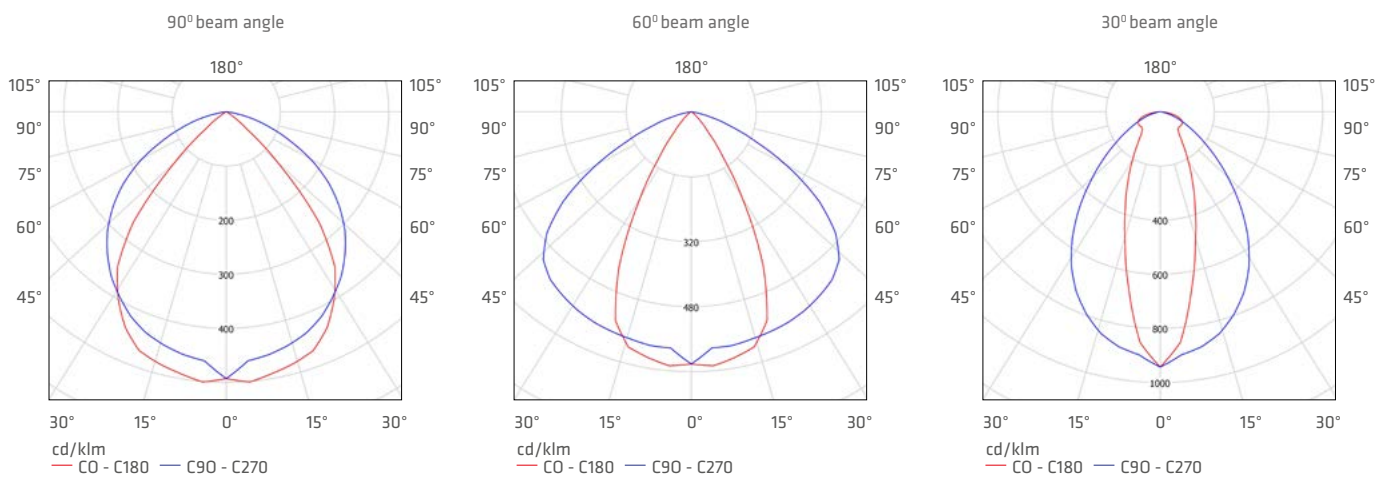

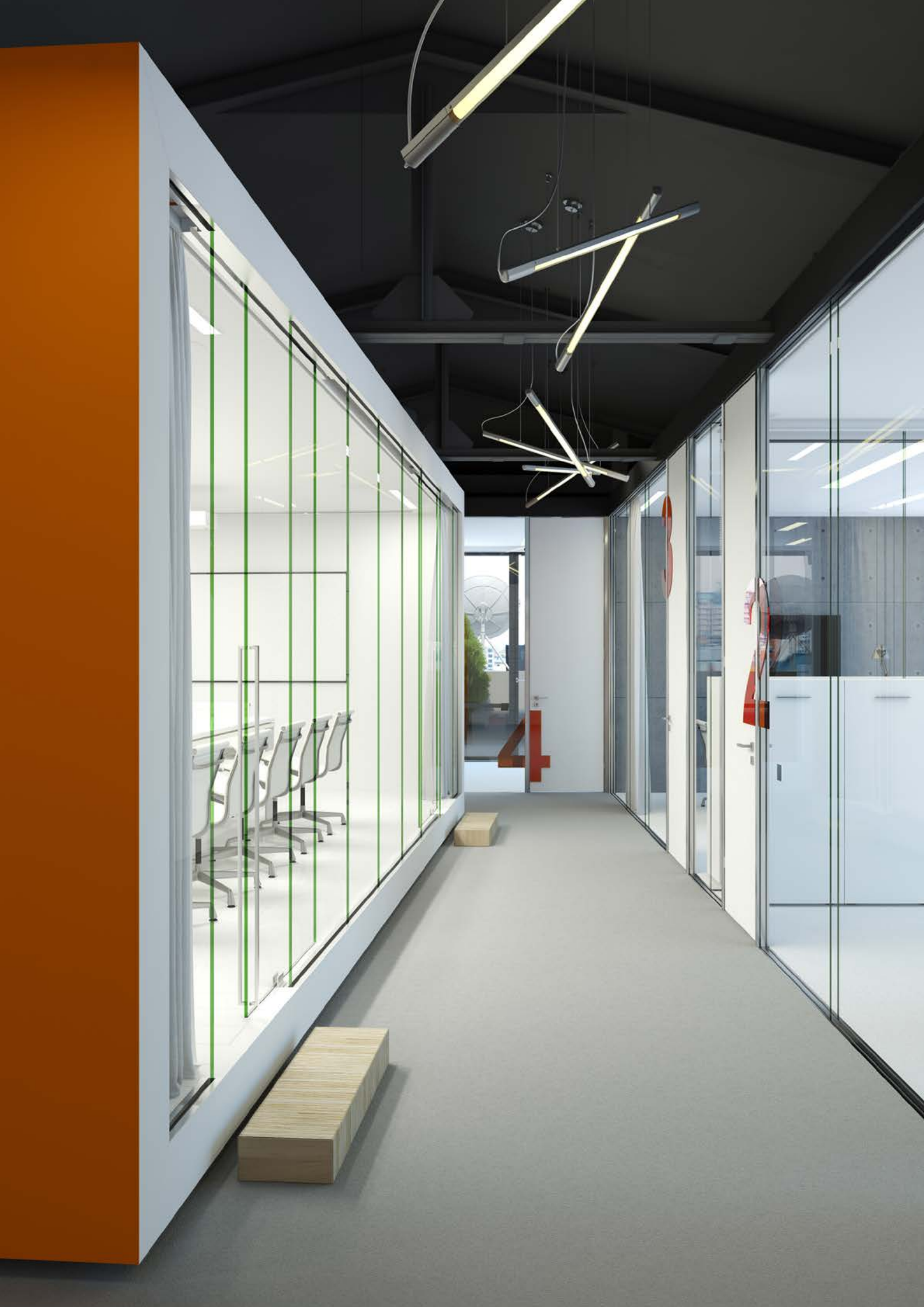

TUBE LED SYSTEM EVO

INDUSTRIAL LIGHTING

LED GO!

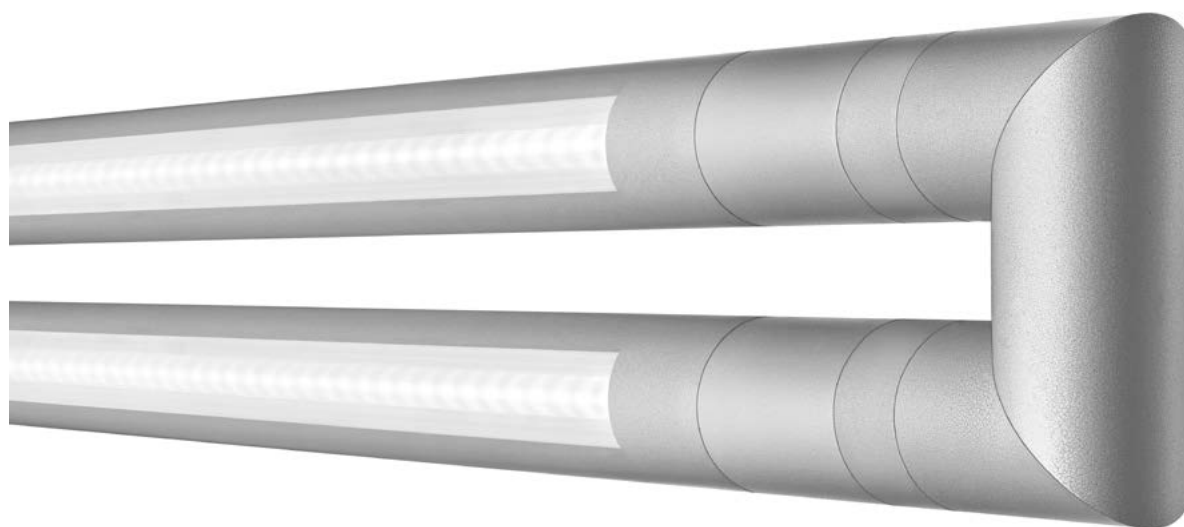

SPECIFICATION

Ingress protection class:	IP65
Impact resistance:	IK08
Total luminous flux*:	max. 3950lm (4000K)
Colour temperature (CCT):	4000K
Energy efficiency class (EEI):	A+ A
Power supply:	220-240V / 50-60Hz
Mounting:	suspended / surface
Body:	PC
Diffuser:	PC OPAL

LED luminaire system designed for suspended and surface mounting on walls and ceilings. With TUBE system connectors it is possible to design light lines in a variety of configurations (I, C, L). It provides a combination of high light parameters and functionality. With its slim diameter of 42 mm is possible to mount in hard-to-reach locations. Through-wiring available. Easy and quick installation: access to terminal block and mounting hole after removing the end cap. Due to the line lens, it is possible to adjust the fitting to different lighting requirements - three light distribution options: 90°, 60°, 30°. Colour temperature 3000K/4000K, CRI>80, lifespan of LED 50 000h (L70B50) $t_a = 25^\circ\text{C}$.

LIGHT BEAM CURVES

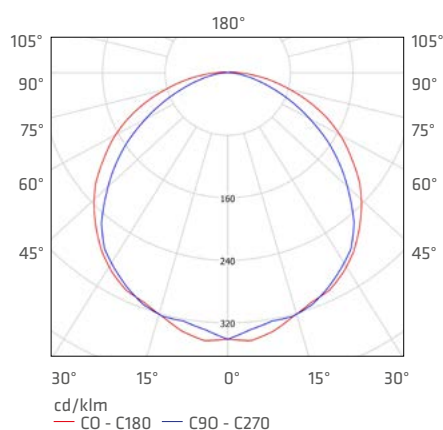

APPLICATION

Luminaire intended for both outdoor and indoor use in industry areas and passageways. It can be used in offices, commercial and service facilities and also to highlight architectural details on facades of buildings.

TUBE LED SYSTEM EVO

INDUSTRIAL LIGHTING

TUBE LED SYSTEM EVO 14W

IP65 | IK08 | 

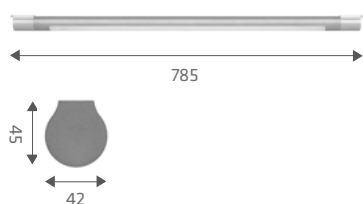

0,80  KG

rated power [W]	colour temperature [K]	total luminous flux* [lm]	beam angle	EEI	index
14	4000	1250	30°	A	267307
14	4000	1600	60°	A+	267314
14	4000	1500	90°	A	267321

TUBE LED SYSTEM EVO 21W

IP65 | IK08 | 



1,00  KG

rated power [W]	colour temperature [K]	total luminous flux* [lm]	beam angle	EEI	index
21	4000	1900	30°	A	267390
21	4000	2350	60°	A+	267406
21	4000	2200	90°	A	267413

TUBE LED SYSTEM EVO 28W

IP65 | IK08 | 

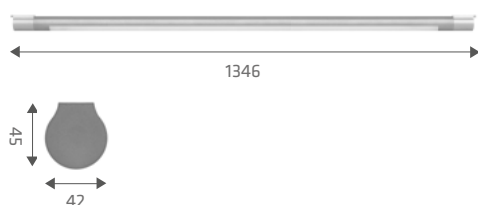

1,20  KG

rated power [W]	colour temperature [K]	total luminous flux* [lm]	beam angle	EEI	index
28	4000	2500	30°	A	267482
28	4000	3100	60°	A+	267499
28	4000	2900	90°	A	267505

TUBE LED SYSTEM EVO 36W

IP65 | IK08 | 



1,50  KG

rated power [W]	colour temperature [K]	total luminous flux* [lm]	beam angle	EEI	index
36	4000	3150	30°	A	267574
36	4000	3950	60°	A+	267581
36	4000	3700	90°	A	267598

TUBE LED SYSTEM EVO

INDUSTRIAL LIGHTING

ACCESSORIES

index	article name
266836	System connector type C (without cables)
266843	System connector type L (without cables)
266669	System connector type C
266676	System connector type L
266683	System; linear suspended set
266652	System; end cap set
266591	Electrical suspended cord (IP20)
266829	Suspended cord (round box)
266607	Suspended cord



266836



266843



266669



266676



266683



266652



266591



266829



266607

TUBE LED SYSTEM EVO

INDUSTRIAL LIGHTING

TECHNICAL DETAILS

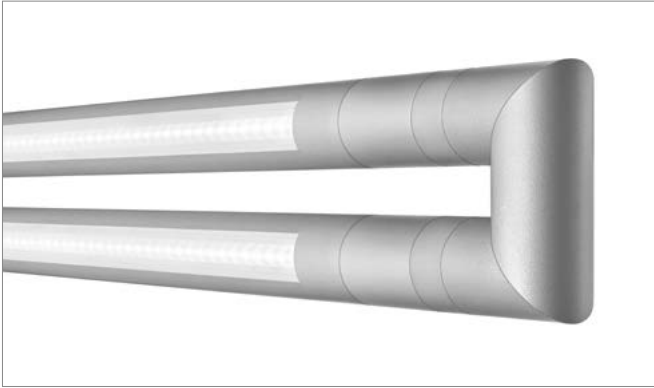

TUBE LED SYSTEM EVO - „C” type line

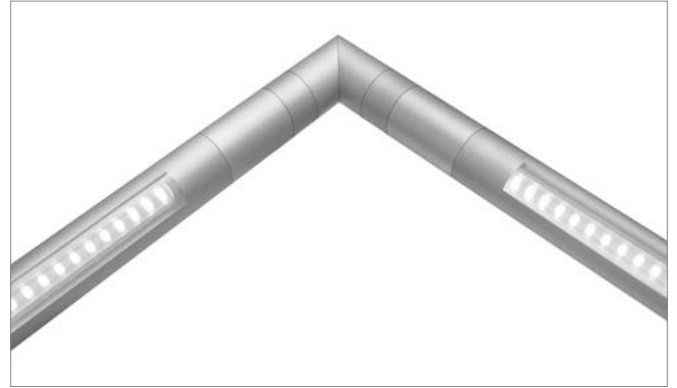

TUBE LED SYSTEM EVO - „L” type line

LIGHT BEAM CURVES

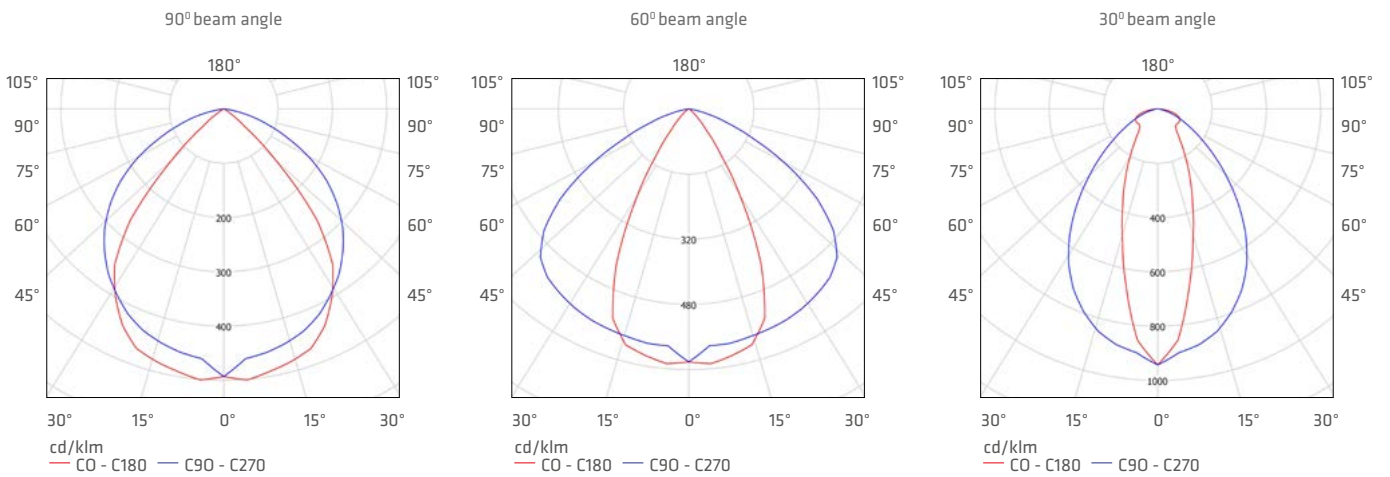

CONNECT LED

INDUSTRIAL LIGHTING

LED GO!



SPECIFICATION

Ingress protection class:	IP20
Total luminous flux*:	max. 17 000lm (4000K)
Colour temperature (CCT):	4000K
Energy efficiency class (EEI):	A+, A
Power supply:	220-240V / 50-60Hz
Mounting:	suspended
Body:	aluminium, plastic end caps
Reflector / Diffuser:	PMMA OPAL, HE reflector

CONNECT LED is a system of suspended industrial lighting line. Luminaire with integrated energy-saving LED GO! panel, made of high quality materials (anodized aluminium profile). It contains the patented HE reflector that guarantees efficiency at the level of 88% and effectively reduces glare effect. Available option with a PMMA diffuser. The fitting's construction allows to adjust the placement of slings along its entire length and enables to connect fittings in line. Through-wiring enables quick assembly of the fitting. Specification: colour temperature 4000K; CRI>80; lifespan of LED panels 50 000 hours (L70B50) $t_a = 25^\circ\text{C}$

LIGHT BEAM CURVES

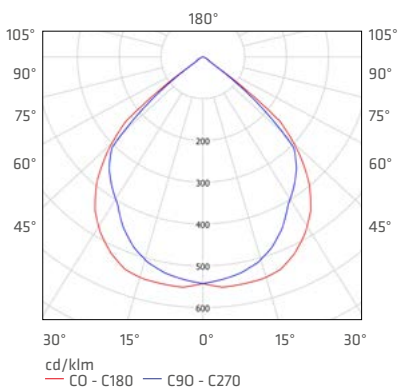

APPLICATION

This multi-function LED luminaire is intended for use inside buildings, particularly recommended for lighting commercial buildings, production facilities and warehouses. It works perfectly both in new applications, as well as when replacing traditional fluorescent luminaires with energy-saving LED solutions.

CONNECT LED

INDUSTRIAL LIGHTING

CONNECT LED 1360

IP20 | 

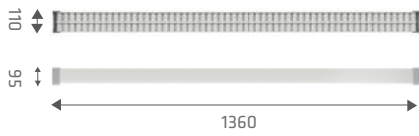

4,60  KG

rated power [W]	colour temperature [K]	total luminous flux* [lm]	diffuser	EEL	index
40	4000	4350	HE	A+	479007
80	4000	8500	HE	A+	479014
40	4000	2900	OPAL	A	479137
80	4000	6300	OPAL	A	479144

CONNECT LED 2720

IP20 | 

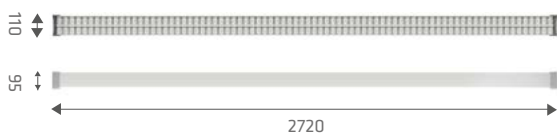

8,10  KG

rated power [W]	colour temperature [K]	total luminous flux* [lm]	diffuser	EEL	index
2x40	4000	8700	HE	A+	479021
2x80	4000	17000	HE	A+	479038
2x40	4000	5800	OPAL	A	479151
2x80	4000	12600	OPAL	A	479168

* Initial, tolerance +/- 10%

Available options: **DALI, 1-10V**

TECHNICAL DETAILS



HE reflector



OPAL cover



Suspension grip



Fitting with cable module

CONNECT LED

INDUSTRIAL LIGHTING

ACCESSORIES

index	article name	notes
479182	Connected LED cable module A=1360mm	Includes through wiring, does not include the LED GO! panel; includes suspension - 1 pce
479175	Connected LED cable module A=2720mm	Includes through wiring, does not include the LED GO! panel; includes suspensions - 2 pcs
479045	Closing set	Required both to complete the single luminaire and light line. Also included: suspension - 2 pcs., plugs - 2 pcs, terminal block - 1 pcs
479199	Additional suspension	-
479205	Emergency luminaire and mounting bracket	-



Cable module (479182, 479175)



Closing set (479045)



Additional suspension (479199)



Emergency luminaire and mounting bracket (479205)





LINEA LED

INDUSTRIAL LIGHTING

PANEL
LED GO!

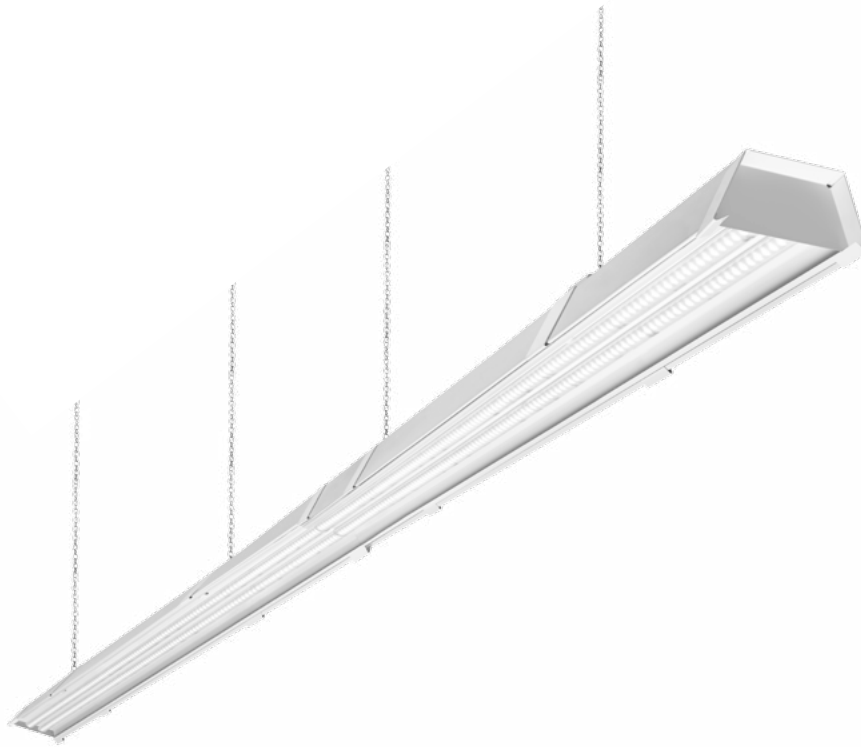

IP20

SPECIFICATION

Ingress protection class:	IP20
Total luminous flux*:	max. 9650lm / 4000K
Colour temperature (CCT):	4000K
Energy efficiency class (EEI):	A+
Power supply:	220-240V / 50-60Hz
Insulation class:	I
Mounting:	surface / suspended
Body:	powder coated steel
Optical system:	PMMA OPAL linear lens

System of suspended industrial lighting line with integrated energy-saving LED GO! light source. Through-wiring and line connector enable quick assembly of the fitting. Equipped with a unique panel mounting systems facilitating the easy assembly of the product. Available with various types of optic: 90°, 60° 45° 20°, asymmetric and butterfly.

LIGHT BEAM CURVES

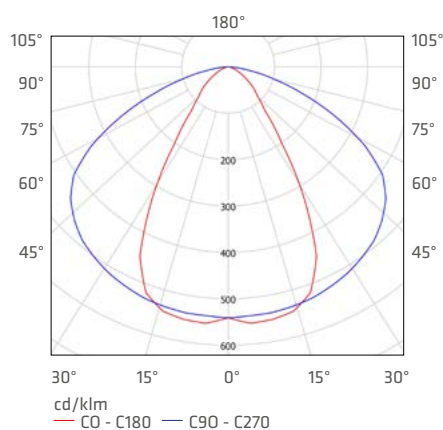

APPLICATION

Particularly well suited for indoor use. Dedicated as the primary light source for commercial facilities, manufacturing plants and warehouses. It is appropriate for new applications as well as replacing conventional T8 & T5 fittings on energy-saving LED solutions.

LINEA LED 36W

IP20 

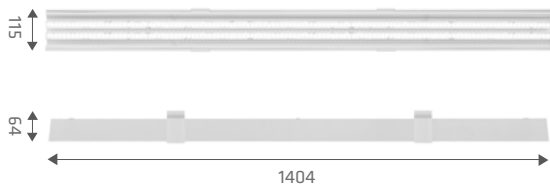

3,4  KG

power [W]	colour temperature [K]	total luminous flux* [lm]	angle	EEl	index
36	4000	4850	90°	A+	150425
36	4000	4750	60°	A+	150432
36	4000	4650	45°	A+	150449
36	4000	4200	20°	A+	150456
36	4000	4400	asymmetric	A+	150463

LINEA LED 72W

IP20 

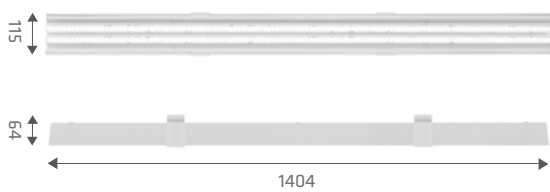

3,6  KG

power [W]	colour temperature [K]	total luminous flux* [lm]	angle	EEl	index
72	4000	9650	90°	A+	150364
72	4000	9500	60°	A+	150371
72	4000	9350	45°	A+	150388
72	4000	8400	20°	A+	150395
72	4000	8800	asymmetric	A+	150401
72	4000	8700	butterfly	A+	150418

LINEA LED MODULE LS2

IP20 



3,1  KG

index

150609

*Initial, tolerance +/- 10%

Available options: **DALI**

LINEA LED

INDUSTRIAL LIGHTING

ACCESSORIES

index	article name
150340	Closing set
150357	Suspensions set



Suspensions set (150357)

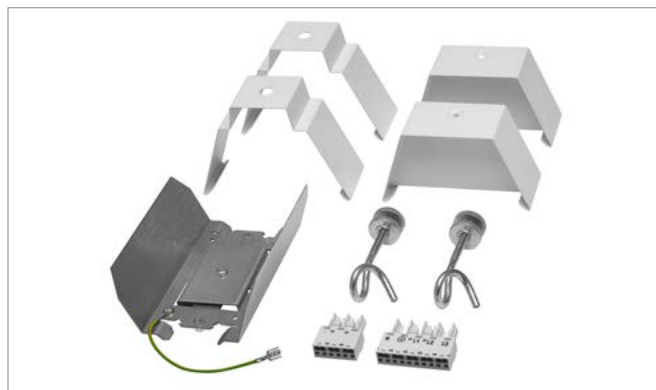

Closing set (150340)

TECHNICAL DETAILS

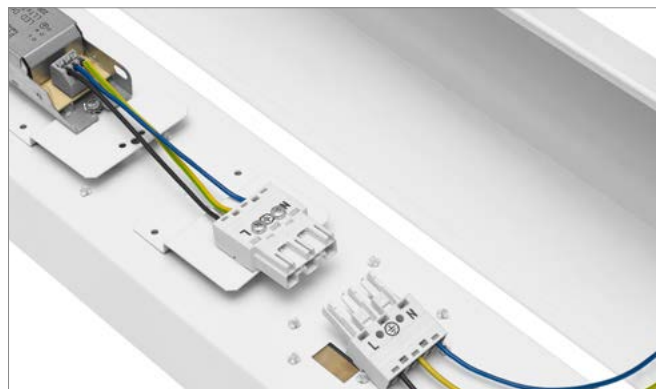
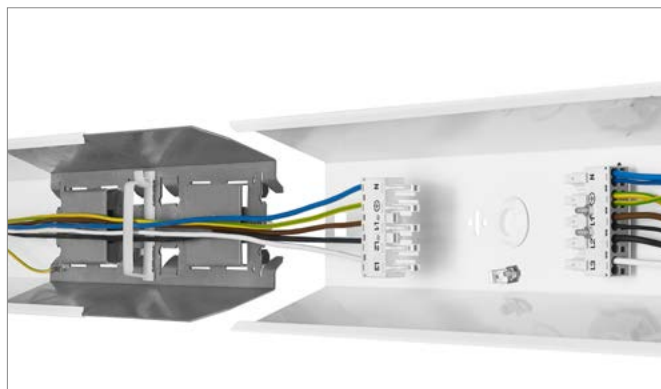

LIGHT DISTRIBUTION TYPES

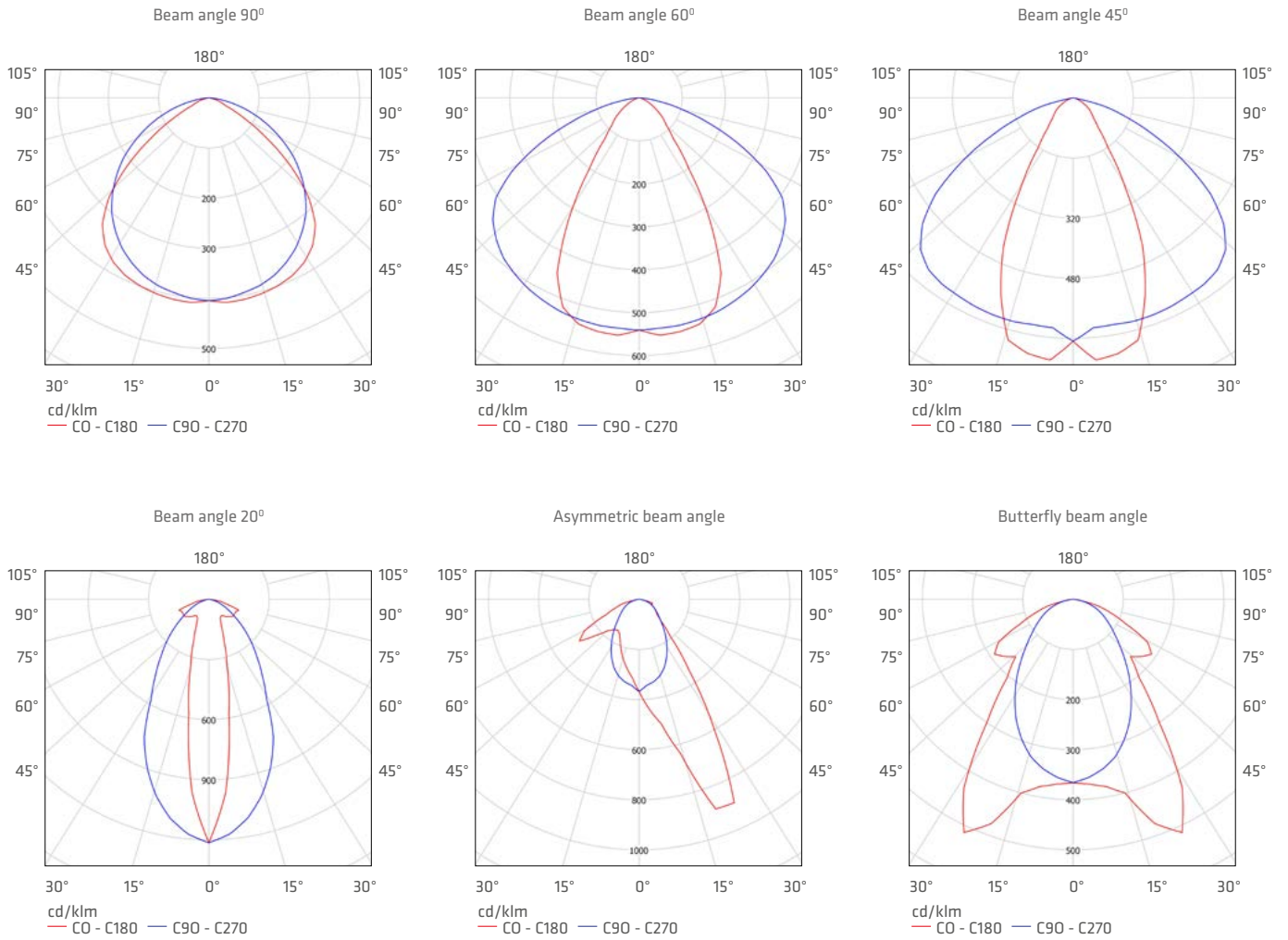

INDUSTRY LED

INDUSTRIAL LIGHTING

LED GO!



SPECIFICATION

Ingress protection class:	IP23
Total luminous flux*:	max. 13400lm (4000K)
Colour temperature (CCT):	4000K
Energy efficiency class (EEI):	A+
Power supply:	220-240V / 50-60Hz
Mounting:	surface / suspended (mounting kit not included)
Body:	galvanized steel
Optical system:	PMMA linear lens

Galvanized steel sheet Industrial luminaire with IP23, with in-built energy-saving LED GO! panels. Thanks to line lenses, following light distribution angles are available: 90°, 60°, 45°, 20°, asymmetric and “butterfly”. Colour temperature 4000K, CRI>80, lifespan of LED 50 000h (L70B50) $t_a=25^{\circ}\text{C}$.

LIGHT BEAM CURVES

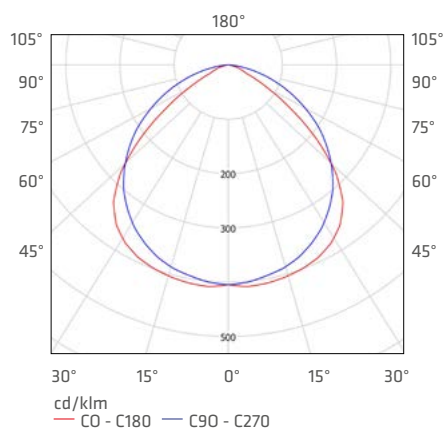



APPLICATION

Luminaire intended for warehouses, large stores, production halls and sports facilities. Meant for new installations and replacement of traditional T8 & T5 luminaires with energy saving LED sources.

INDUSTRY LED 48W

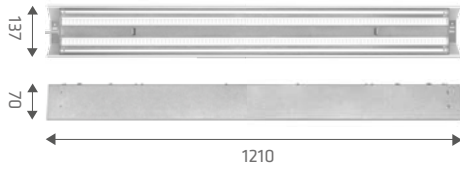
IP23 | 





3,0 (LS1) / 3,2 (LS2) 

rated power [W]	colour temperature [K]	total luminous flux* [lm]	beam angle	Rapid	EEL	index
48	4000	5900	20°	LS1	A+	540639
48	4000	6500	45°	LS1	A+	540622
48	4000	6600	60°	LS1	A+	540615
48	4000	6700	90°	LS1	A+	540608
48	4000	6150	asymmetrical	LS1	A+	540592
48	4000	6050	butterfly	LS1	A+	540585
48	4000	5900	20°	LS2	A+	540578
48	4000	6500	45°	LS2	A+	540561
48	4000	6600	60°	LS2	A+	540554
48	4000	6700	90°	LS2	A+	540547
48	4000	6150	asymmetrical	LS2	A+	540530
48	4000	6050	butterfly	LS2	A+	540523

INDUSTRY LED 62W

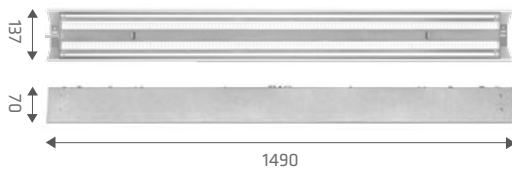
IP23 | 





3,7 (LS1) / 3,9 (LS2) 

rated power [W]	colour temperature [K]	total luminous flux* [lm]	beam angle	Rapid	EEL	index
62	4000	8400	20°	LS1	A+	540158
62	4000	9350	45°	LS1	A++	540141
62	4000	9500	60°	LS1	A++	540134
62	4000	9650	90°	LS1	A++	540127
62	4000	8800	asymmetrical	LS1	A+	540110
62	4000	8700	butterfly	LS1	A+	540103
62	4000	8400	20°	LS2	A+	540097
62	4000	9350	45°	LS2	A++	540080
62	4000	9500	60°	LS2	A++	540073
62	4000	9650	90°	LS2	A++	540066
62	4000	8800	asymmetrical	LS2	A+	540059
62	4000	8700	butterfly	LS2	A+	540042

INDUSTRY LED 72W

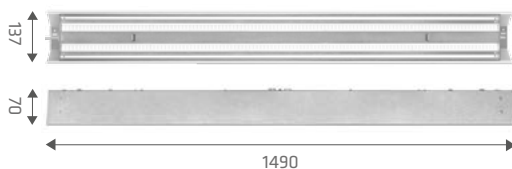
IP23 | 



3,7 (LS1) / 3,9 (LS2) 

rated power [W]	colour temperature [K]	total luminous flux* [lm]	beam angle	Rapid	EEL	index
72	4000	8400	20°	LS1	A+	541032
72	4000	9350	45°	LS1	A+	541025
72	4000	9500	60°	LS1	A+	541018
72	4000	9650	90°	LS1	A+	541001
72	4000	8800	asymmetrical	LS1	A+	541049
72	4000	8700	butterfly	LS1	A+	541056
72	4000	8400	20°	LS2	A+	541094
72	4000	9350	45°	LS2	A+	541087
72	4000	9500	60°	LS2	A+	541070
72	4000	9650	90°	LS2	A+	541063
72	4000	8800	asymmetrical	LS2	A+	541100
72	4000	8700	butterfly	LS2	A+	541117

* Initial, tolerance +/- 10%

INDUSTRY LED

INDUSTRIAL LIGHTING

INDUSTRY LED 90W

IP23 | 

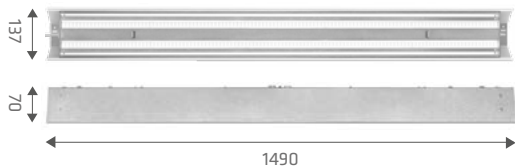

3,7 (LS1) / 3,9 (LS2) 

rated power [W]	colour temperature [K]	total luminous flux* [lm]	beam angle	Rapid	EEl	index
90	4000	11750	20°	LS1	A+	540394
90	4000	13000	45°	LS1	A++	540387
90	4000	13250	60°	LS1	A++	540370
90	4000	13400	90°	LS1	A++	540363
90	4000	12300	asymmetrical	LS1	A+	540356
90	4000	12150	butterfly	LS1	A+	540349
90	4000	11750	20°	LS2	A+	540332
90	4000	13000	45°	LS2	A++	540325
90	4000	13250	60°	LS2	A++	540318
90	4000	13400	90°	LS2	A++	540301
90	4000	12300	asymmetrical	LS2	A+	540295
90	4000	12100	butterfly	LS2	A+	540288

* Pacztkowy, tolerancja +/- 10%

Available options: **DALI**, **RAL colour**

ACCESSORIES

index	nazwa
541247	Chain sling (2 pcs.)
543944	Hook for hanging on a string (2 pcs.)
541254	Protective grid (for 1490mm)
540004	Aluminium louver (for 1490mm)



Chain sling (541247)

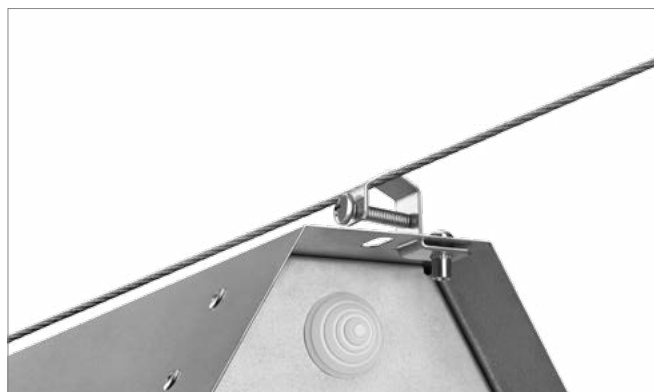

Hook for hanging on a string (543944)

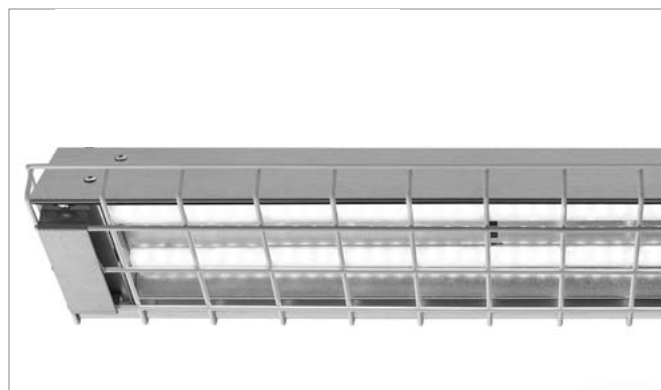

Protective grid (541254)



Aluminium louver (540004)

LIGHT DISTRIBUTION TYPES

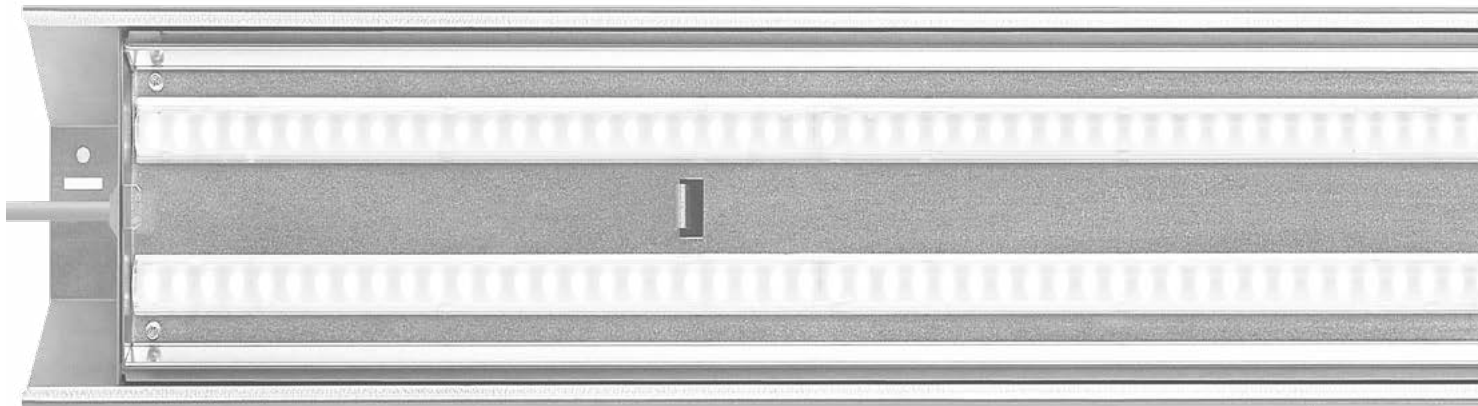
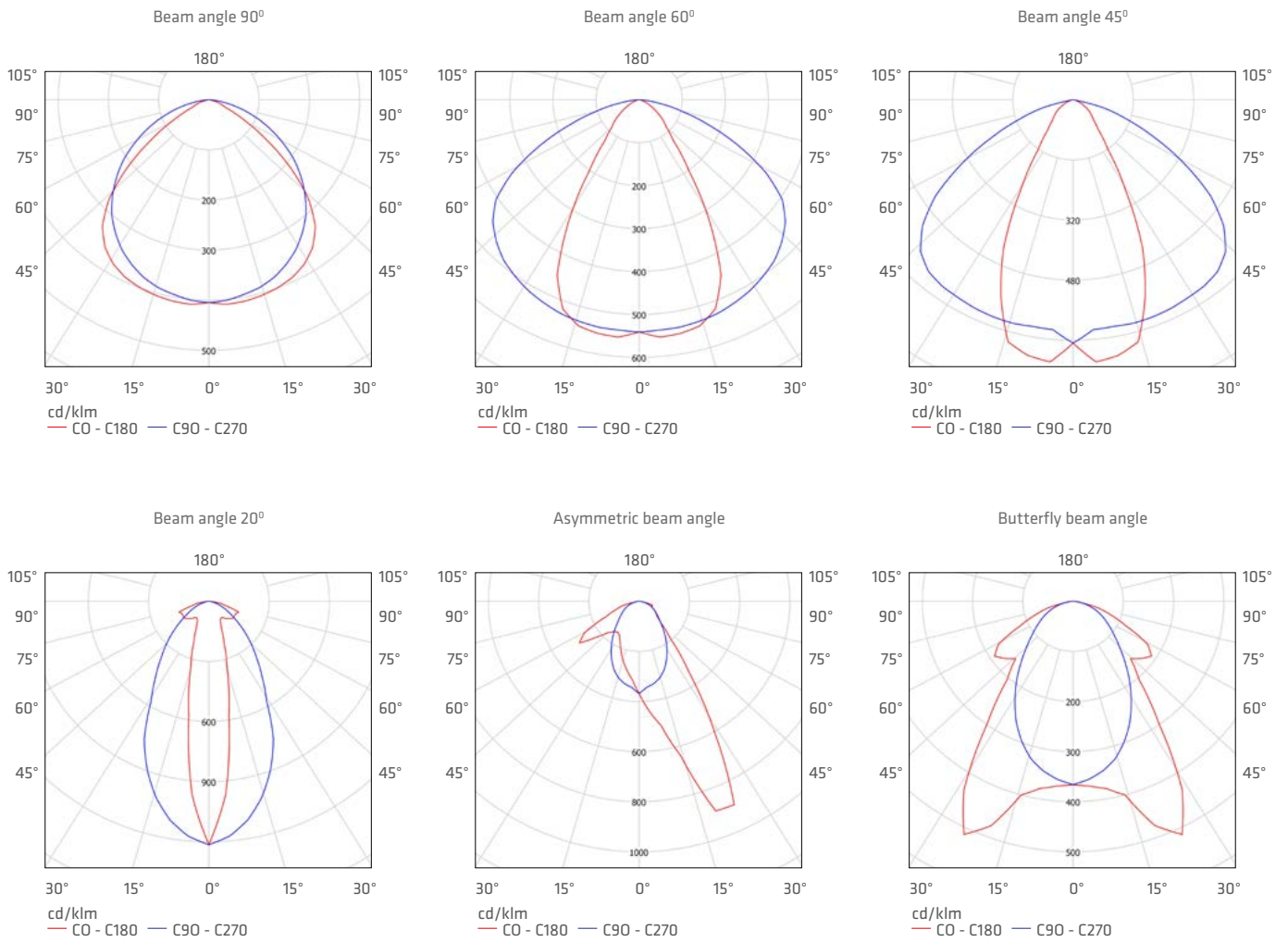

VECTOR LED

INDUSTRIAL LIGHTING

LED GO!



SPECIFICATION

Ingress protection class:	IP40
Total luminous flux*:	max. 5900lm (4000K)
Colour temperature (CCT):	3000K, 4000K
Energy efficiency class (EEI):	A
Power supply:	220-240V / 50-60Hz
Mounting:	surface
Body:	powder coated steel
Diffuser:	PMMA PRM, PRM MAT

Surface mounted luminaire for ceilings and walls. Equipped with energy saving LED GO! panels. Powder painted steel base. Special UV resistant single layer opal diffuser. Colour temperature 3000K/4000K, CRI>80, lifespan of LED 50 000h (L70B50) $t_a=25^{\circ}\text{C}$.

LIGHT BEAM CURVES

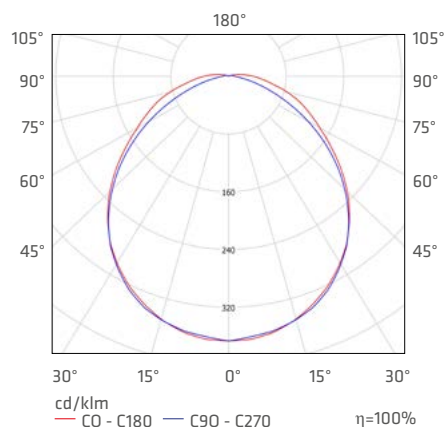

APPLICATION

Multi-purpose LED luminaire designed for indoor application. Especially recommended for public rooms and corridors (administration buildings, schools, universities and health care buildings). Opal diffuser secures against glare effect. Appropriate for new applications as well as replacing conventional T8 & T5 fittings for energy saving LED solutions. Fitting construction adapted for surface mounting (ceiling) using the included accessory installation kit.

VECTOR LED

INDUSTRIAL LIGHTING

VECTOR LED 646

IP40 

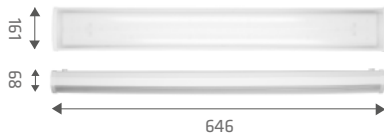

2,25 

rated power [W]	colour temperature [K]	total luminous flux* [lm]	diffuser	EEl	index
16	3000	1210	PRM MAT	A	180408
16	3000	1500	PRM	A	180422
16	4000	1300	PRM MAT	A	180415
16	4000	1600	PRM	A	180439
24	3000	1800	PRM MAT	A	180064
24	3000	2300	PRM	A	180071
24	4000	1950	PRM MAT	A	180040
24	4000	2500	PRM	A	180057

VECTOR LED 912

IP40 



3,50 

rated power [W]	colour temperature [K]	total luminous flux* [lm]	diffuser	EEl	index
24	3000	1800	PRM MAT	A	180484
24	3000	2250	PRM	A	180507
24	4000	1950	PRM MAT	A	180491
24	4000	2500	PRM	A	180514
36	3000	2700	PRM MAT	A	180521
36	3000	3350	PRM	A	180545
36	4000	2900	PRM MAT	A	180538
36	4000	3750	PRM	A	180552

VECTOR LED 1258

IP40 

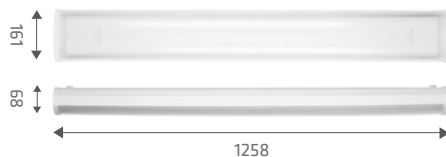

3,70 

rated power [W]	colour temperature [K]	total luminous flux* [lm]	diffuser	EEl	index
32	3000	2400	PRM MAT	A	180187
32	3000	2950	PRM	A	180194
32	4000	2600	PRM MAT	A	180163
32	4000	3300	PRM	A	180170
48	3000	3550	PRM MAT	A	180224
48	3000	4500	PRM	A	180231
48	4000	3800	PRM MAT	A	180200
48	4000	5000	PRM	A	180217

VECTOR LED 1558

IP40 



4,60 

rated power [W]	colour temperature [K]	total luminous flux* [lm]	diffuser	EEl	index
40	3000	3150	PRM MAT	A	180262
40	3000	3750	PRM	A	180279
40	4000	3450	PRM MAT	A	180248
40	4000	4100	PRM	A	180255
60	3000	4900	PRM MAT	A	180446
60	3000	5500	PRM	A	180460
60	4000	4900	PRM MAT	A	180453
60	4000	5950	PRM	A	180477

* Initial, tolerance +/- 10%

Available options: **RCR** (motion sensor), **DALI**.

VECTOR II LED

INDUSTRIAL LIGHTING

LED GO!



SPECIFICATION

Ingress protection class:	IP40
Total luminous flux*:	max. 5900lm (4000K)
Colour temperature (CCT):	3000K, 4000K
Energy efficiency class (EEI):	A
Power supply:	220-240V / 50-60Hz
Mounting:	surface
Body:	powder coated steel
Diffuser:	PMMA PRM, PRM MAT

Surface mounted luminaire for ceilings and walls. Equipped with energy saving LED GO! panels. Powder painted steel base. Special UV resistant single layer opal diffuser. Colour temperature 3000K/4000K, CRI>80, lifespan of LED 50 000h (L70B50) $t_a = 25^\circ\text{C}$.

LIGHT BEAM CURVES

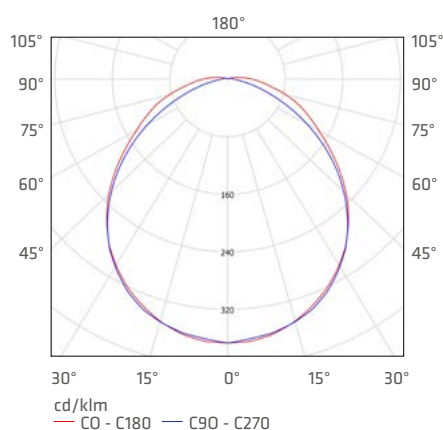

APPLICATION

Multi-purpose LED luminaire designed for indoor application. Especially recommended for public rooms and corridors (administration buildings, schools, universities and health care buildings). Opal diffuser secures against glare effect. Appropriate for new applications as well as replacing conventional T8 & T5 fittings for energy saving LED solutions. Fitting construction adapted for surface mounting (ceiling) using the included accessory installation kit.

VECTOR II LED

INDUSTRIAL LIGHTING

VECTOR II LED 16W

IP40 | 



1,70  KG

rated power [W]	colour temperature [K]	total luminous flux* [lm]	diffuser	EEI	index
16	4000	960	PRM MAT	A	179181

VECTOR II LED 32W

IP40 | 



2,65  KG

rated power [W]	colour temperature [K]	total luminous flux* [lm]	diffuser	EEI	index
32	4000	2850	PRM MAT	A	179198

VECTOR II LED 40W

IP40 | 



2,65  KG

rated power [W]	colour temperature [K]	total luminous flux* [lm]	diffuser	EEI	index
40	4000	3550	PRM MAT	A	179204

VECTOR II LED 48W

IP40 | 

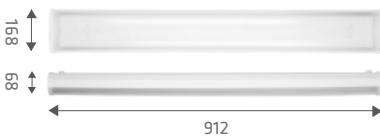

1,70  KG

rated power [W]	colour temperature [K]	total luminous flux* [lm]	diffuser	EEI	index
48	3000	3150	PRM MAT	A	179259
48	4000	3500	PRM MAT	A	179235
48	3000	4150	PRM	A	179297
48	4000	4600	PRM	A	179273

VECTOR II LED 64W

IP40 | 



2,65  KG

rated power [W]	colour temperature [K]	total luminous flux* [lm]	diffuser	EEI	index
64	3000	4000	PRM MAT	A	179266
64	4000	4450	PRM MAT	A	179242
64	3000	5300	PRM	A	179303
64	4000	5900	PRM	A	179280

* Initial, tolerance +/- 10%

Available options: **RCR** (motion sensor).

FORTAN LED

INDUSTRIAL LIGHTING

LED GO!

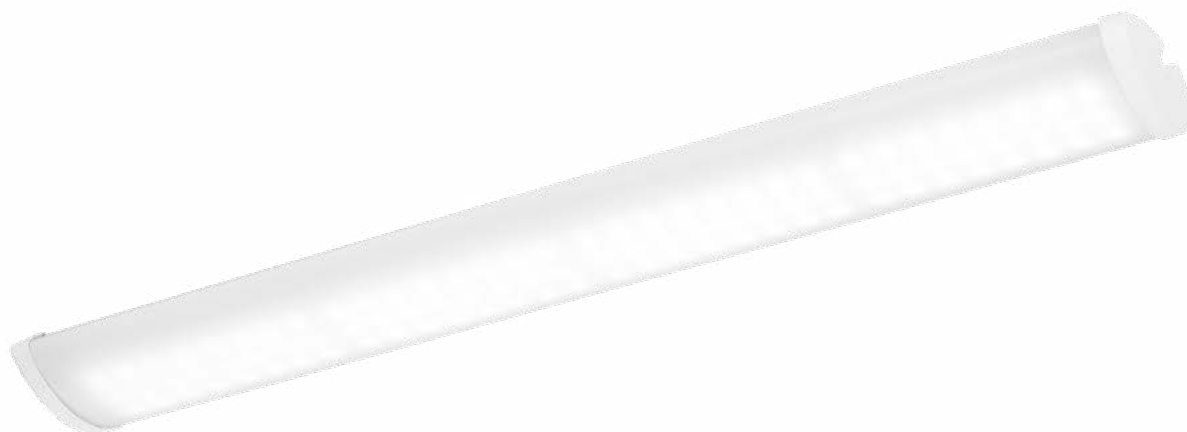

SPECIFICATION

Ingress protection class:	IP44
Total luminous flux*:	max. 6200lm (4000K)
Colour temperature (CCT):	3000K, 4000K
Energy efficiency class (EEI):	A
Power supply:	220-240V / 50-60Hz
Mounting:	surface
Body:	powder coated steel
Diffuser:	PMMA PRM, PRM MAT

Surface or wall mounted high performance LED luminaire with IP44. Equipped with energy saving LED GO! panels. Powder painted steel base. Two diffusers available: highly efficient multilayer prismatic PMMA and UV resistant diffuser and single layer milky UV resistant PMMA diffuser. Luminaire prepared for easy installation into continuous row lighting system. Colour temperature 3000K/4000K, CRI>80, lifespan of LED 50 000h (L70B50) $t_a = 25^\circ\text{C}$.

LIGHT BEAM CURVES

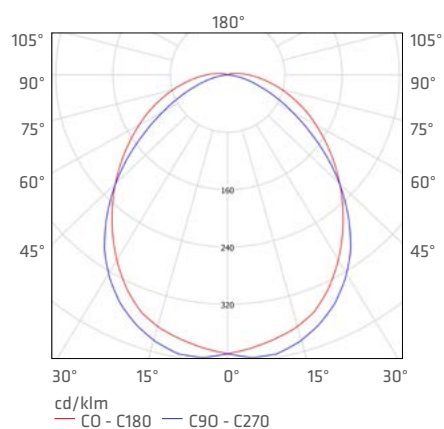

APPLICATION

Multi-purpose LED luminaire designed for indoor application. Especially recommended for public rooms and corridors (administration buildings, schools, universities and health care buildings). Appropriate for new applications as well as replacing conventional T8 & T5 fittings for energy saving LED solutions. Fitting construction adapted for surface mounting (ceiling) using the included accessory installation kit.

FORTAN LED 630

IP44 

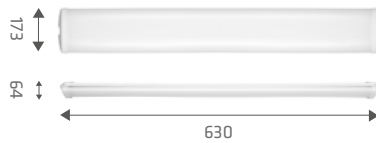

1,20  KG

rated power [W]	colour temperature [K]	total luminous flux* [lm]	diffuser	sensor	EEl	index
16	3000	1300	PRM MAT	-	A	386909
16	3000	1600	PRM	-	A	386923
16	4000	1400	PRM MAT	-	A	386916
16	4000	1700	PRM	-	A	386930
24	3000	1950	PRM MAT	-	A	386565
24	3000	2200	PRM	-	A	386572
24	4000	2050	PRM MAT	-	A	386541
24	4000	2400	PRM	-	A	386558
24	3000	1950	PRM MAT	RCR	A	387265
24	4000	2050	PRM MAT	RCR	A	387302

FORTAN LED 1285

IP44 

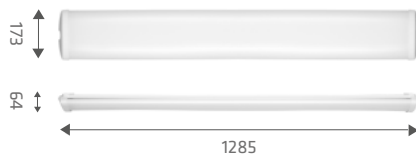

2,40  KG

rated power [W]	colour temperature [K]	total luminous flux* [lm]	diffuser	sensor	EEl	index
32	3000	2400	PRM MAT	-	A	386688
32	3000	2600	PRM	-	A	386695
32	4000	2600	PRM MAT	-	A	386664
32	4000	3200	PRM	-	A	386671
32	3000	2400	PRM MAT	RCR	A	387272
32	4000	2600	PRM MAT	RCR	A	387326
48	3000	3900	PRM MAT	-	A	386725
48	3000	4800	PRM	-	A	386732
48	4000	4200	PRM MAT	-	A	386701
48	4000	5200	PRM	-	A	386718
48	3000	3900	PRM MAT	RCR	A	387289
48	4000	4200	PRM MAT	RCR	A	387319

FORTAN LED 1585

IP44 



3,24  KG

rated power [W]	colour temperature [K]	total luminous flux* [lm]	diffuser	sensor	EEl	index
40	3000	2900	PRM MAT	-	A	386763
40	3000	3600	PRM	-	A	386770
40	4000	3250	PRM MAT	-	A	386749
40	4000	4000	PRM MAT	-	A	386756
60	3000	4550	PRM MAT	-	A	386947
60	3000	5750	PRM	-	A	386961
60	4000	4900	PRM MAT	-	A	386954
60	4000	6200	PRM	-	A	386978
60	3000	4550	PRM MAT	RCR	A	387296
60	4000	4900	PRM MAT	RCR	A	387333

* Initial, tolerance +/- 10%

Available options: **DALI**

FORTAN LED SYSTEM

INDUSTRIAL LIGHTING

LED GO!



SPECIFICATION

Ingress protection class:	IP20
Total luminous flux*:	max. 4850lm (4000K)
Colour temperature (CCT):	4000K
Energy efficiency class (EEI):	A
Power supply:	220-240V / 50-60Hz
Mounting:	suspended
Body:	powder coated steel
Diffuser:	PMMA PRM MAT

High illumination parameters system meant for hanging. With the use of the system connector it is possible to build a light line of max. 30 fittings connected longitudinally. System equipped with energy saving LED GO! panels. Powder painted steel base and milky UV resistant PMMA diffuser. Available with DALI. Colour temperature 4000K, CRI>80, lifespan of LED 50 000h (L70B50) $t_a= 25^{\circ}\text{C}$.

LIGHT BEAM CURVES

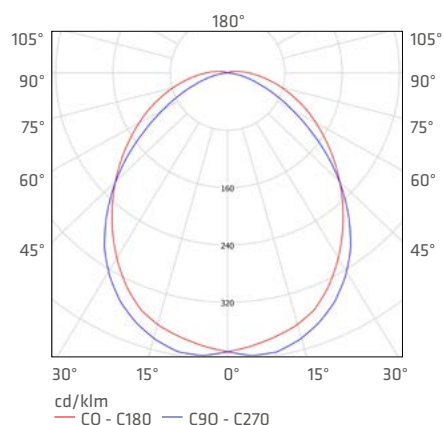

APPLICATION

Multi-function LED luminaire intended for use inside buildings, particularly recommended for lighting usable rooms and corridors in public buildings (administration, education, healthcare). It works perfectly while designing new applications as well as replacing traditional fluorescent luminaires with energy-saving LED solutions.

FORTAN LED SYSTEM

INDUSTRIAL LIGHTING

FORTAN LED 630

IP20 

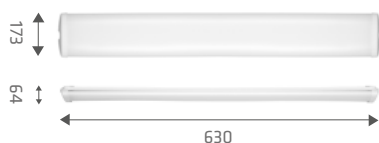

1,20  KG

rated power [W]	colour temperature [K]	total luminous flux* [lm]	diffuser	EEL	type	index
16	4000	1400	PRM MAT	A	K	387234
16	4000	1400	PRM MAT	A	S	387227
24	4000	2150	PRM MAT	A	K	387159
24	4000	2150	PRM MAT	A	S	387142

FORTAN LED 1285

IP20 

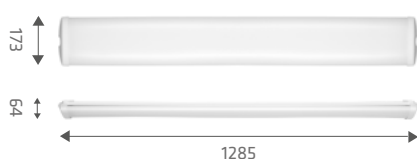

2,40  KG

rated power [W]	colour temperature [K]	total luminous flux* [lm]	diffuser	EEL	type	index
32	4000	2850	PRM MAT	A	K	387173
32	4000	2850	PRM MAT	A	S	387166
48	4000	4300	PRM MAT	A	K	387197
48	4000	4300	PRM MAT	A	S	387180

FORTAN LED 1585

IP20 



3,24  KG

rated power [W]	colour temperature [K]	total luminous flux* [lm]	diffuser	EEL	type	index
40	4000	3600	PRM MAT	A	K	387210
40	4000	3600	PRM MAT	A	S	387203
60	4000	4850	PRM MAT	A	K	387258
60	4000	4850	PRM MAT	A	S	387241

* Initial, tolerance +/- 10%

K - end module, S - continuous line (system plug in set)

ACCESSORIES

index	article name
UL00393	System plug
UL00394	Power cord with system plug
171512	single suspended cord
171505	single electrical suspended cord (round box)
171635	single suspended cord (round box)



UL00393



UL00394



171512



171505, 171581 (DALI)



171635

FORTAN LED SYSTEM

INDUSTRIAL LIGHTING

TECHNICAL DETAILS



Light line connection



Connection set (included)



Quick-release coupling (socket/plug)



Suspension mounting bracket





SPECTO LED

INDUSTRIAL LIGHTING

LED GO!



SPECIFICATION

Ingress protection class:	IP40
Total luminous flux*:	max. 4400lm (4000K)
Colour temperature (CCT):	3000K, 4000K
Energy efficiency class (EEI):	A
Power supply:	220-240V / 50-60Hz
Mounting:	surface
Body:	powder coated steel
Diffuser:	PMMA PRM, PRM MAT

Surface mounted fitting for ceilings and walls. Equipped with energy saving LED GO! panels. Powder painted steel base. Two diffusers available: highly efficient multilayer prismatic PMMA and UV resistant diffuser and single layer milky UV resistant diffuser. Colour temperature 3000K/4000K, CRI>80, LED lifespan of LED 50 000h (L70B50) $t_a = 25^\circ\text{C}$.

LIGHT BEAM CURVES

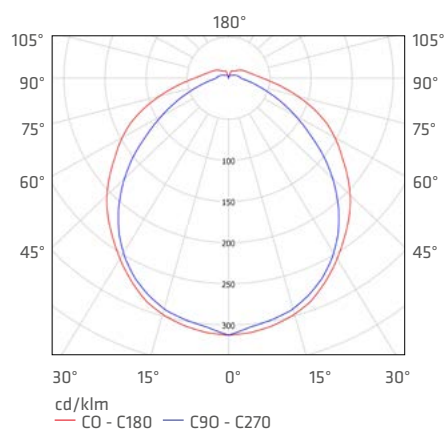

APPLICATION

Multi-purpose LED luminaire designed for indoor application. Especially recommended for public rooms and corridors (administration buildings, schools, universities and health care buildings). Appropriate for new applications as well as replacing conventional T8 & T5 fittings for energy saving LED solutions. Fitting construction adapted for surface mounting (ceiling) using the included accessory installation kit.

SPECTO LED

INDUSTRIAL LIGHTING

SPECTO LED 642

IP40 

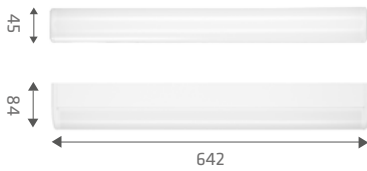



1,10  KG

rated power [W]	colour temperature [K]	total luminous flux* [lm]	diffuser	EEl	index
8	3000	600	PRM MAT	A	343667
8	3000	700	PRM	A	343605
8	4000	700	PRM MAT	A	343674
8	4000	820	PRM	A	343612
16	3000	1300	PRM MAT	A	343742
16	3000	1550	PRM	A	343728
16	4000	1400	PRM MAT	A	343759
16	4000	1650	PRM	A	343735

SPECTO LED 902

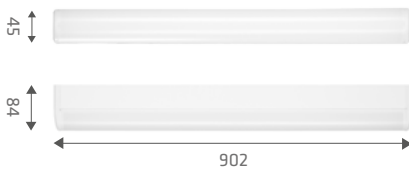
IP40 



1,30  KG

rated power [W]	colour temperature [K]	total luminous flux* [lm]	diffuser	EEl	index
12	3000	1000	PRM MAT	A	343780
12	3000	1150	PRM	A	343766
12	4000	1050	PRM MAT	A	343797
12	4000	1250	PRM	A	343773
24	3000	2300	PRM	A	343803
24	3000	2050	PRM MAT	A	343827
24	4000	2500	PRM	A	343810
24	4000	2200	PRM MAT	A	343834

SPECTO LED 1252

IP40 



1,70  KG

rated power [W]	colour temperature [K]	total luminous flux* [lm]	diffuser	EEl	index
16	3000	1300	PRM MAT	A	343865
16	3000	1550	PRM	A	343841
16	4000	1450	PRM MAT	A	343872
16	4000	1650	PRM	A	343858
32	3000	3200	PRM MAT	A	343902
32	3000	3050	PRM	A	343889
32	4000	2800	PRM MAT	A	343919
32	4000	3300	PRM	A	343896

SPECTO LED 1552

IP40 



2,10  KG

rated power [W]	colour temperature [K]	total luminous flux* [lm]	diffuser	EEl	index
20	3000	1850	PRM MAT	A	343940
20	3000	2100	PRM	A	343926
20	4000	2000	PRM MAT	A	343957
20	4000	2250	PRM	A	343933
40	3000	3450	PRM MAT	A	343704
40	3000	4050	PRM	A	343643
40	4000	3750	PRM MAT	A	343711
40	4000	4400	PRM	A	343650

* Initial, tolerance +/- 10%

RAX LED

INDUSTRIAL LIGHTING

LED



SPECIFICATION

Ingress protection class:	IP40
Total luminous flux*:	max. 2150lm (4000K)
Colour temperature (CCT):	3000K, 4000K
Energy efficiency class (EEI):	A+
Power supply:	220-240V / 50-60Hz
Mounting:	surface
Body:	PC, aluminium
Diffuser:	PC OPAL

Energy-saving LED under-cabinet luminaire of minimalist design. The high-performance LED's used, with high colour rendering index, give a bright and comfortable light. The integrated diffuser of impact-resistant polycarbonate ensures uniform, well dispersed light. Thin end caps minimize dark areas at the ends of luminaires when building continuous lines. Accessories for mounting and connecting modules included. Possibility of combining continuous lines consisting of up to 10 modules. Colour temperature 3000K, 4000K, CRI>80.

LIGHT BEAM CURVES

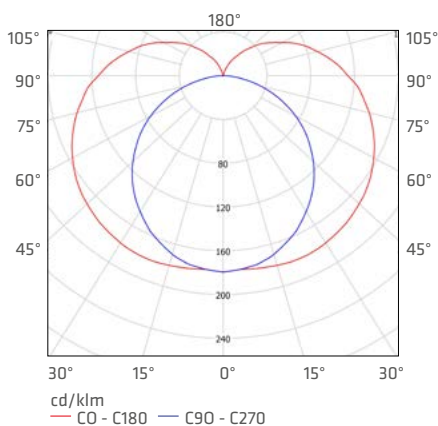

APPLICATION

Discreet design and compact size make the RAX LED luminaire an ideal solution for both domestic premises, offices, shops, as well as warehouses. Dedicated to install in a limited space such as spaces under cabinets. RAX LED provides enough light to illuminate shelves in stores and warehouses as well as working areas.

RAX LED 10W

IP40 



0,15  KG

rated power [W]	colour temperature [K]	total luminous flux* [lm]	diffuser	EEL	index
10	3000	950	OPAL	A+	072017
10	4000	1040	OPAL	A+	072024

RAX LED 20W

IP40 

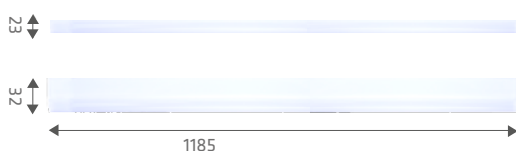

0,29  KG

rated power [W]	colour temperature [K]	total luminous flux* [lm]	diffuser	EEL	index
20	3000	2000	OPAL	A+	072031
20	4000	2150	OPAL	A+	072048

* Initial, tolerance +/- 10%

ACCESSORIES



Accessories in set



Supply wire 1m - 072093 (optional)

FACTOR LED Z

INDUSTRIAL LIGHTING

LED GO!



SPECIFICATION

Ingress protection class:	IP65
Total luminous flux*:	max. 31 000lm (5700K)
Impact resistance:	IK10
Colour temperature (CCT):	4000K, 5700K
CRI (Ra):	>80 (4000K) >70 (5700K)
Energy efficiency class (EEI):	A, A+
Power supply:	220-240V / 50-60Hz
Mounting:	suspended
Body:	powder coated steel, aluminium
Diffuser:	Makrolon® LED OPAL

Universal HIGH BAY type luminaire of modern design. The luminaire is equipped with high power LED panels with opal diffusers made of Makrolon® LED (BAYER) with very high light transmittance of 93%. Available version with max power 260W with very high flux 31 000 lumens. The highly impact-resistant diffuser allows maintaining a high level of impact resistance, IK10. Very good alternative for 400W metal halide lamp or 250W sodium lamp. Optics of various illumination angle (30°/115° or 90°) is available. Instant start without flickering. Colour temperature 4000K, 5700K, CRI>70 (5700K), CRI>80 (4000K). Lifespan of LED 50 000h (L70B50) $t_a = 25^\circ\text{C}$

LIGHT BEAM CURVES

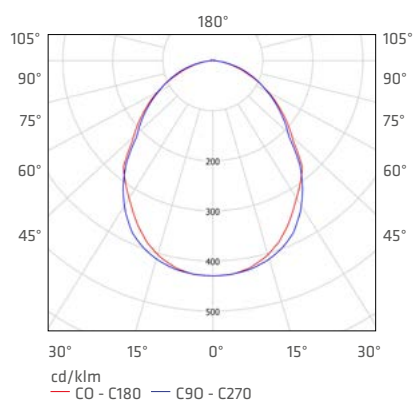

APPLICATION

The luminaire is dedicated for suspended installation with chains, for both internal and external use. It is designed for industrial plants, production halls and large area warehouses.

FACTOR LED 156W

IP65 | IK10 | 

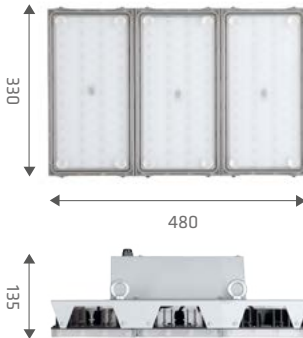

10,4  KG

rated power [W]	colour temperature [K]	total luminous flux* [lm]	diffuser	beam angle	EEL	index
156	4000	16800	makrolon®LED OPAL	90	A+	090134
156	5700	20550	makrolon®LED OPAL	90	A+	090141
156	4000	14450	makrolon®LED OPAL	30/115	A	090790
156	5700	17700	makrolon®LED OPAL	30/115	A+	090936

FACTOR LED 208W

IP65 | IK10 | 



12,0  KG

rated power [W]	colour temperature [K]	total luminous flux* [lm]	diffuser	beam angle	EEL	index
208	4000	22400	makrolon®LED OPAL	90	A+	090196
208	5700	27400	makrolon®LED OPAL	90	A+	090202
208	4000	18750	makrolon®LED OPAL	30/115	A	090806
208	5700	22950	makrolon®LED OPAL	30/115	A+	090943

FACTOR LED 260W

IP65 | IK10 | 



13,6  KG

rated power [W]	colour temperature [K]	total luminous flux* [lm]	diffuser	beam angle	EEL	index
260	4000	28000	makrolon®LED OPAL	90	A+	090257
260	5700	34250	makrolon®LED OPAL	90	A+	090264
260	4000	23500	makrolon®LED OPAL	30/115	A	090813
260	5700	28750	makrolon®LED OPAL	30/115	A+	090950

* Initial, tolerance +/- 10%

FACTOR LED N

INDUSTRIAL LIGHTING

LED GO!



SPECIFICATION

Ingress protection class:	IP65
Total luminous flux*:	max. 27 400lm (5700K)
Impact resistance:	IK10
Colour temperature (CCT):	4000K, 5700K
CRI (Ra):	>80 (4000K) >70 (5700K)
Energy efficiency class (EEI):	A, A+
Power supply:	220-240V / 50-60Hz
Mounting:	surface
Body:	powder coated steel, aluminium
Diffuser:	Makrolon® LED OPAL

Universal HIGH BAY type luminaire of modern design. The luminaire is equipped with high power LED panels with opal diffusers made of Makrolon® LED (BAYER) with very high light transmittance of 93%. Available version with max power 208W with very high flux 24 800 lumens. The highly impact-resistant diffuser allows maintaining a high level of impact resistance, IK10. Optics of various illumination angle (30°/115° or 90°) is available. Instant start without flickering. Colour temperature 4000K, 5700K, CRI>70 (5700K), CRI>80 (4000K). Lifespan of LED 50 000h (L70B50) $t_a = 25^\circ\text{C}$

LIGHT BEAM CURVES

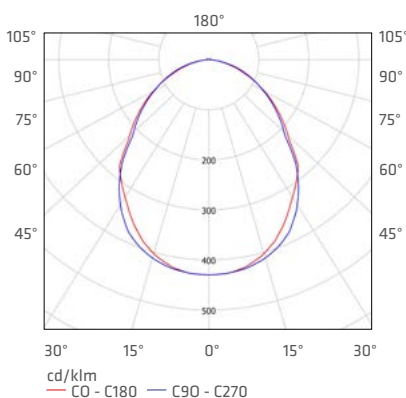

APPLICATION

The luminaire is dedicated for surface installation, for both internal and external use. It is designed for industrial plants, production halls, large- area warehouses, storage sheds and manufacturing sites, including fuel stations, sports halls and gyms.

FACTOR LED N

INDUSTRIAL LIGHTING

FACTOR LED 104W

IP65 | IK10 | 

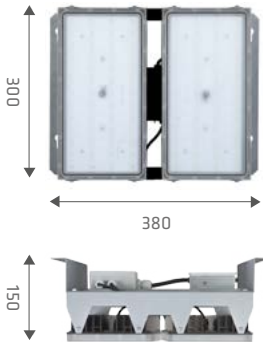

6,6  KG

rated power [W]	colour temperature [K]	total luminous flux* [lm]	diffuser	beam angle	EEl	index
104	4000	11200	makrolon®LED OPAL	90	A+	090448
104	5700	13700	makrolon®LED OPAL	90	A+	090455
104	4000	9400	makrolon®LED OPAL	30/115	A	090905
104	5700	11500	makrolon®LED OPAL	30/115	A+	090974

FACTOR LED 156W

IP65 | IK10 | 

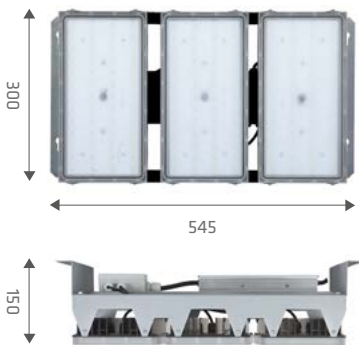

8,5  KG

rated power [W]	colour temperature [K]	total luminous flux* [lm]	diffuser	beam angle	EEl	index
156	4000	16800	makrolon®LED OPAL	90	A+	090387
156	5700	20550	makrolon®LED OPAL	90	A+	090394
156	4000	14450	makrolon®LED OPAL	30/115	A	090912
156	5700	17700	makrolon®LED OPAL	30/115	A+	090981

FACTOR LED 208W

IP65 | IK10 | 

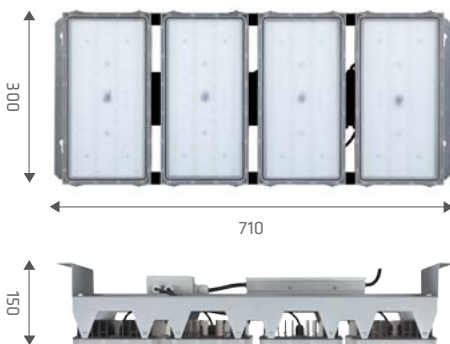

10,3  KG

rated power [W]	colour temperature [K]	total luminous flux* [lm]	diffuser	beam angle	EEl	index
208	4000	22400	makrolon®LED OPAL	90	A	090325
208	5700	27400	makrolon®LED OPAL	90	A+	090332
208	4000	18750	makrolon®LED OPAL	30/115	A	090929
208	5700	22950	makrolon®LED OPAL	30/115	A+	090967

* Initial, tolerance +/- 10%



SPECIFICATION

Ingress protection class:	IP65
Total luminous flux*:	max. 27 400lm (5700K)
Impact resistance:	IK10
Colour temperature (CCT):	4000K, 5700K
CRI (Ra):	>80 (4000K) >70 (5700K)
Energy efficiency class (EEI):	A+, A
Power supply:	220-240V / 50-60Hz
Mounting:	recessed
Body:	powder coated steel, aluminium
Diffuser:	Makrolon® LED OPAL

Low-bay fitting with modern design. The luminaire is equipped with high power LED panels with opal diffusers made of Makrolon® LED (BAYER) with very high light transmittance of 93%. Available version with max power 208W with very high flux 24 800 lumens. The highly impact-resistant diffuser allows maintaining a high level of impact resistance, IK10. Optics of various illumination angle (30°/115° or 90°) is available. Instant start without flickering. Colour temperature 4000K, 5700K, CRI>70 (5700K), CRI>80 (4000K). Lifespan of LED 50 000h (L70B50) $t_a = 25^\circ\text{C}$. Optionally, possibility of using motion sensors and 1-10V electronics.

LIGHT BEAM CURVES

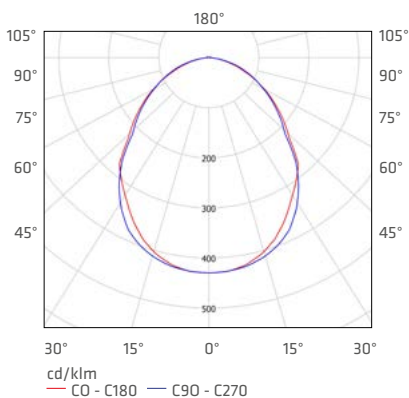



APPLICATION

The luminaire is dedicated for recessed installation, for both internal and external use. It is designed for storage sheds and commercial buildings, including fuel stations, sports halls and gyms.

FACTORIA LED 52W

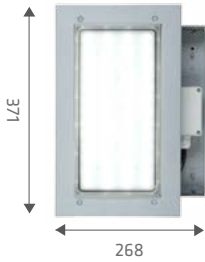
IP65 | IK10 | 





340x170 
3,8 

rated power [W]	colour temperature [K]	total luminous flux* [lm]	diffuser	beam angle	EEI	index
52	4000	5600	makrolon®LED OPAL	90	A	090745
52	5700	6850	makrolon®LED OPAL	90	A	090752
52	4000	4700	makrolon®LED OPAL	30/115	A	090820
52	5700	5750	makrolon®LED OPAL	30/115	A+	090837

FACTORIA LED 104W

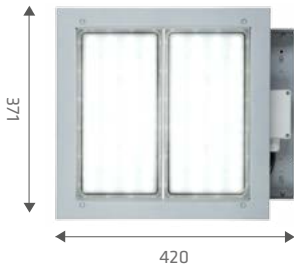
IP65 | IK10 | 





340x320 
5,6 

rated power [W]	colour temperature [K]	total luminous flux* [lm]	diffuser	beam angle	EEI	index
104	4000	11200	makrolon®LED OPAL	90	A+	090684
104	5700	13700	makrolon®LED OPAL	90	A+	090691
104	4000	9400	makrolon®LED OPAL	30/115	A	090844
104	5700	11500	makrolon®LED OPAL	30/115	A+	090851

FACTORIA LED 156W

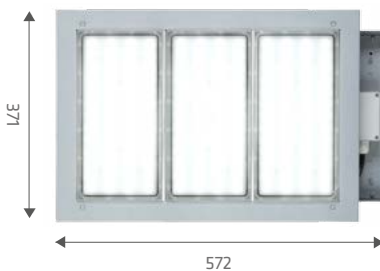
IP65 | IK10 | 



340x480 
7,6 

rated power [W]	colour temperature [K]	total luminous flux* [lm]	diffuser	beam angle	EEI	index
156	4000	16800	makrolon®LED OPAL	90	A+	090622
156	5700	20550	makrolon®LED OPAL	90	A+	090639
156	4000	14450	makrolon®LED OPAL	30/115	A	090868
156	5700	17700	makrolon®LED OPAL	30/115	A+	090875

* Initial, tolerance +/- 10%

FACTORIA LED

INDUSTRIAL LIGHTING

FACTORIA LED 208W

IP65 | IK10 | 

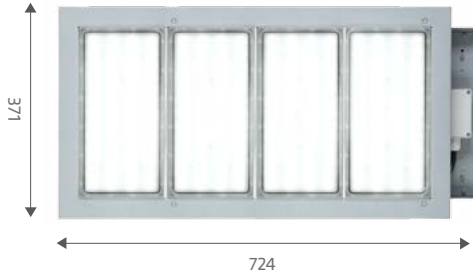

340x630



9,5



Height = 141 mm

* Initial, tolerance +/- 10%

rated power [W]	colour temperature [K]	total luminous flux* [lm]	diffuser	beam angle	EEL	index
208	4000	22400	makrolon®LED OPAL	90	A+	090561
208	5700	27400	makrolon®LED OPAL	90	A+	090578
208	4000	18750	makrolon®LED OPAL	30/115	A	090882
208	5700	22950	makrolon®LED OPAL	30/115	A+	090899

TECHNICAL DETAILS

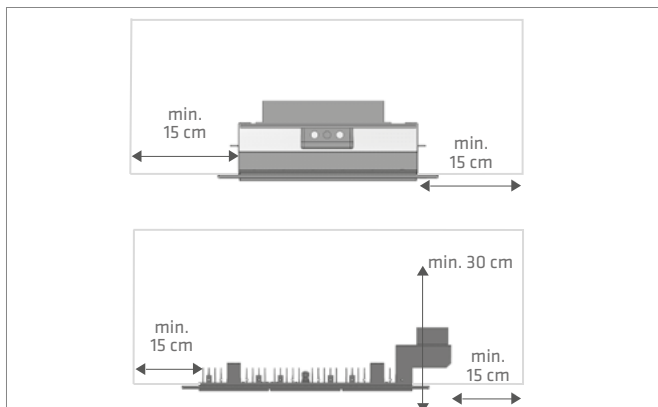

Mounting dimensions



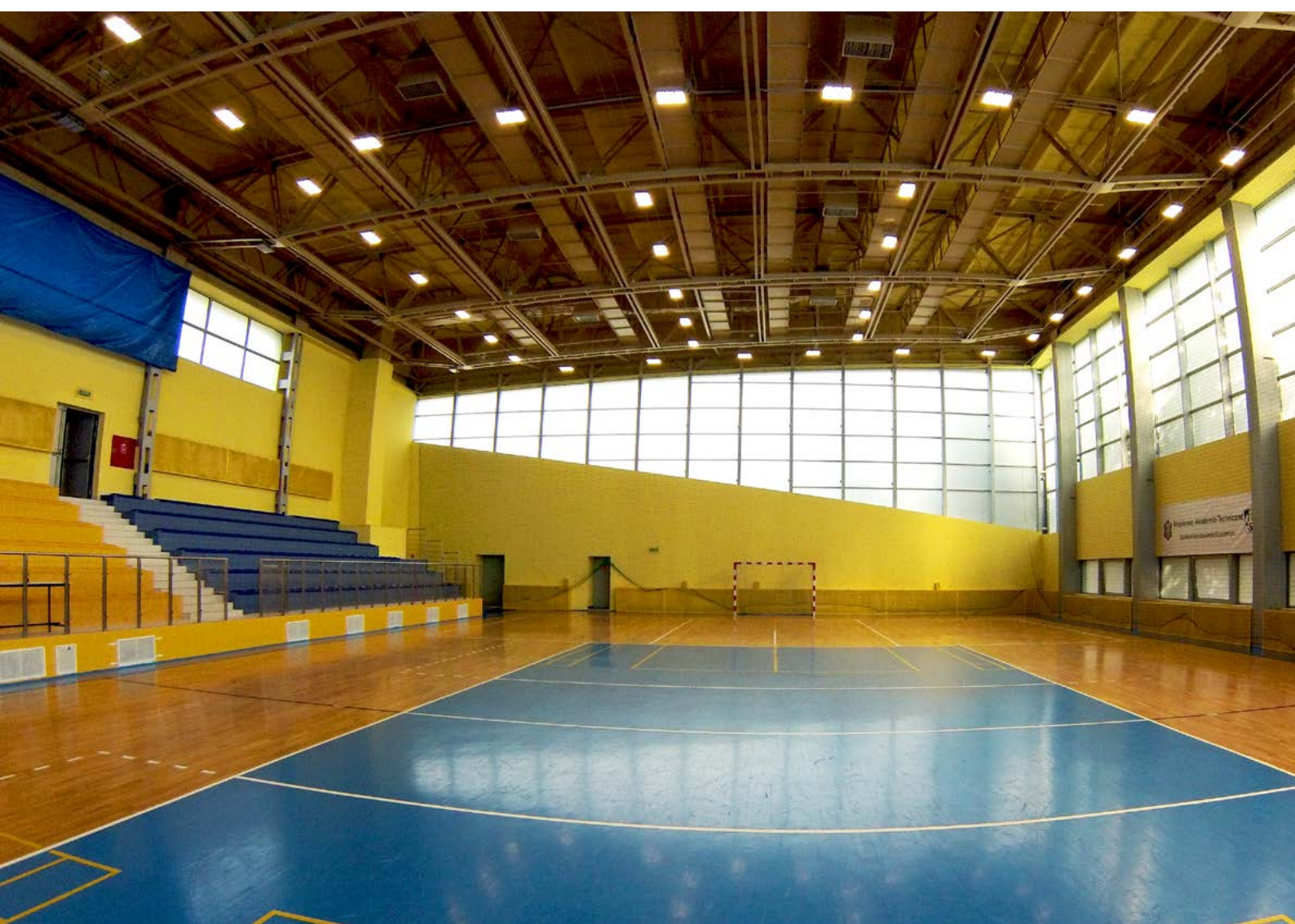

QUEST LED

FLOODLIGHTS



SPECIFICATION

Ingress protection class:	IP66
Impact resistance class:	IK08
Total luminous flux:*	max. 12 400lm (4100K)
Colour temperature (CCT):	4100K
Energy efficiency class (EEI):	A+
Power supply:	230V/50-60Hz
Diffuser	tempered glass
Body:	aluminium
Working temperature:	from -20 ^o to +50 ^o

Energy-saving floodlight fitting uses SMD LED source. A glass, prismatic diffuser and a die-cast aluminium reflector influence its excellent lighting parameters. An aluminium body, a glass diffuser and a metal gasket ensure high ingress protection against water and dust - IP66. A clip and a fast mounting block inside enable electrical connection without using tools. Metal mounting side with an angle adjustment every 15° enables to direct the light beam precisely. Specification: color temperature 4000K, CRI>80.

LIGHT BEAM CURVES

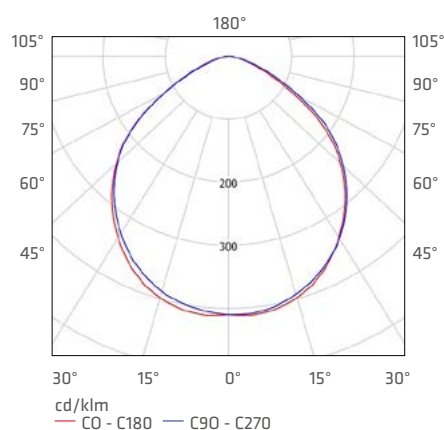

APPLICATION

The fitting is dedicated for lighting elevations and billboards.

QUEST LED

FLOODLIGHTS

QUEST LED 48W

IP66 | IK08 | 

rated power [W]	colour temperature [K]	total luminous flux* [lm]	diffuser	EEL	index
48	4100	5050	TEMPERED GLASS	A+	395949

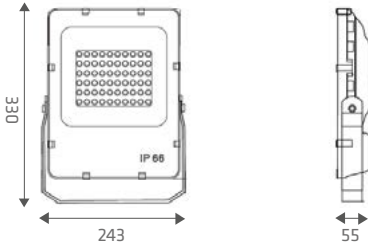

3,1  KG

QUEST LED 72W

IP66 | IK08 | 

rated power [W]	colour temperature [K]	total luminous flux* [lm]	diffuser	EEL	index
72	4100	7100	TEMPERED GLASS	A+	395956

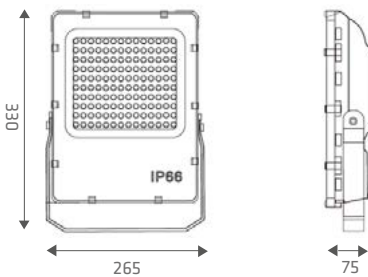

4,8  KG

QUEST LED 120W

IP66 | IK08 | 

rated power [W]	colour temperature [K]	total luminous flux* [lm]	diffuser	EEL	index
120	4100	12 400	TEMPERED GLASS	A+	395963

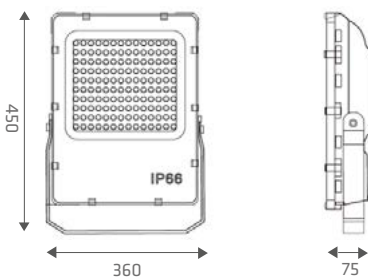

7,5  KG

* Initial, tolerance +/- 10%

TECHNICAL DETAILS



Connection wire type H05RN-F 3x1,00mm, length 1,4 m with a two-core connector, which enables to connect a wire with the max. diameter 3x2,5 mm.

VIGO LED

FLOODLIGHTS

COB LED



SPECIFICATION

Ingress protection class:	IP65
Total luminous flux*:	max. 3500lm (4000K)
Colour temperature (CCT):	4000K, 6000K
Energy efficiency class (EEI):	A
Power supply:	220-240V / 50-60Hz
Mounting:	surface
Diffuser:	tempered glass
Body:	aluminium

Energy-saving floodlight fitting uses COB LED source. The glass diffuser and the extruded high-efficiency aluminium reflector ensure excellent lighting parameters. A robust aluminium body, a glass diffuser and a metal gasket provide it with a high ingress protection class against water and solids - IP65. The quick-fit clip and bracket inside allow for a tool-free electrical connection. A metal mounting arm with angle adjustment every 15° enables to direct the light beam precisely. Specification: colour temperature 4000K, 6000K; CRI>70.

LIGHT BEAM CURVES

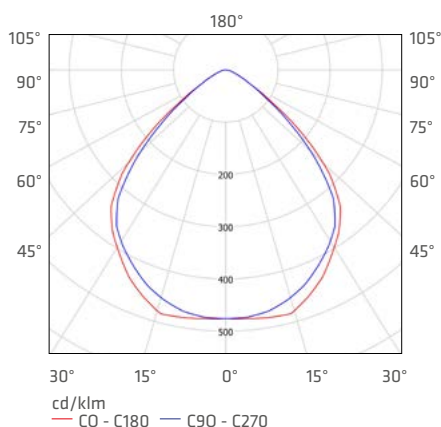

APPLICATION

This luminaire is intended to lighten facades and billboards.

VIGO LED

IP65 | 



3,36 KG 

rated power [W]	colour temperature [K]	total luminous flux* [lm]	diffuser	EEL	index
50	4000	3500	GLASS	A	395680
50	6000	3500	GLASS	A	395697

* Initial, tolerance +/- 10%



VIGO R LED

FLOODLIGHTS

COB LED



SPECIFICATION

Ingress protection class:	IP65
Total luminous flux*:	max. 7550lm (6000K)
Colour temperature (CCT):	6000K
Energy efficiency class (EEI):	A
Power supply:	220-240V / 50-60Hz
Mounting:	surface
Diffuser:	tempered glass
Body:	aluminium

Energy-saving floodlight fitting uses COB LED source. A robust aluminium body, a glass diffuser and a metal gasket provide it with a high ingress protection class against water and solids - IP65. Quick-fit bracket inside speeds up the installation process. Metal mounting arm allows to adjust the angle of lighting. Specification: colour temperature 6000K; CRI>70.

LIGHT BEAM CURVES

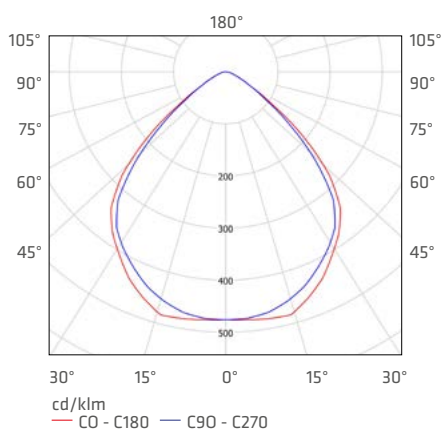

APPLICATION

This luminaire is intended for lighting facades and large billboards.

VIGO R LED

FLOODLIGHTS

VIGO R LED

IP65 | 

rated power [W]	colour temperature [K]	total luminous flux* [lm]	diffuser	EEL	index
100	6000	7550	GLASS	A	395895



5,30  KG

* Initial, tolerance +/- 10%

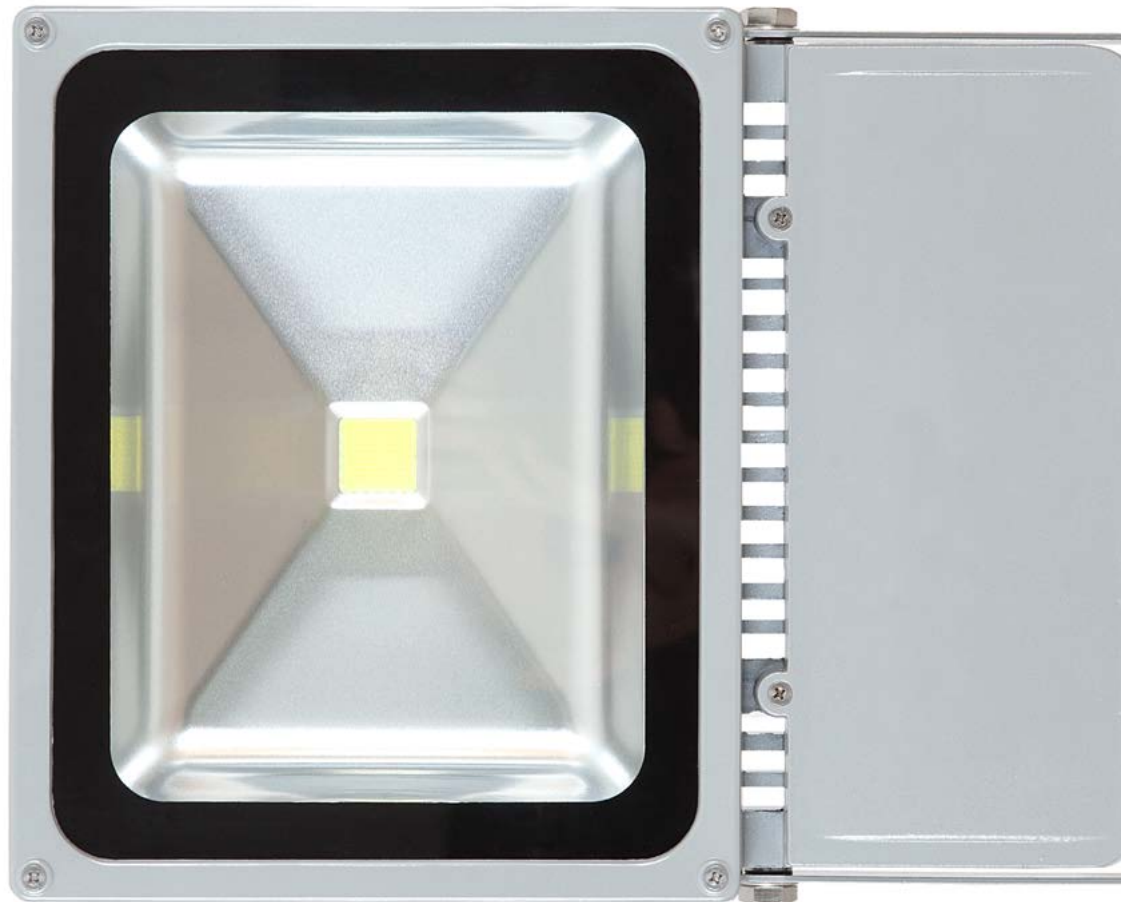





BULKHEADS



PROXIMA LED

Surface mounted LED luminaire with luminous flux of 2300lm. Dedicated for common spaces' decoration.



SPECIFICATION

Ingress protection class IP 65, Impact resistance IK10

DALI/RCR

Available options with DALI module or with radio motion sensor (RCR).

INDIRECT LIGHT

The unique diffuser's profile redistributes part of the light to the surface of the mounting, which creates additional lighting effect.

CASE STUDY

SAVE 68% OF ENERGY THANKS TO PROXIMA LED

During cooperation with our customer, who intended to build a class A energy-saving office building, we considered two alternatives of illumination the stairway and the passageways leading to office space.

In both options luminaires were supposed to be installed on the ceiling. In the first option 55 pieces of 2x26W EVG fluorescent fittings were used, in the second option 32 pieces of PROXIMA LED 24W. According to the directives, both of the solutions ensured the optimum light intensity (brightness) on the rooms' floor: on average 100lx.

The picture below shows the parameters and shape of the stairway together with adjacent routes and the layout of light points.

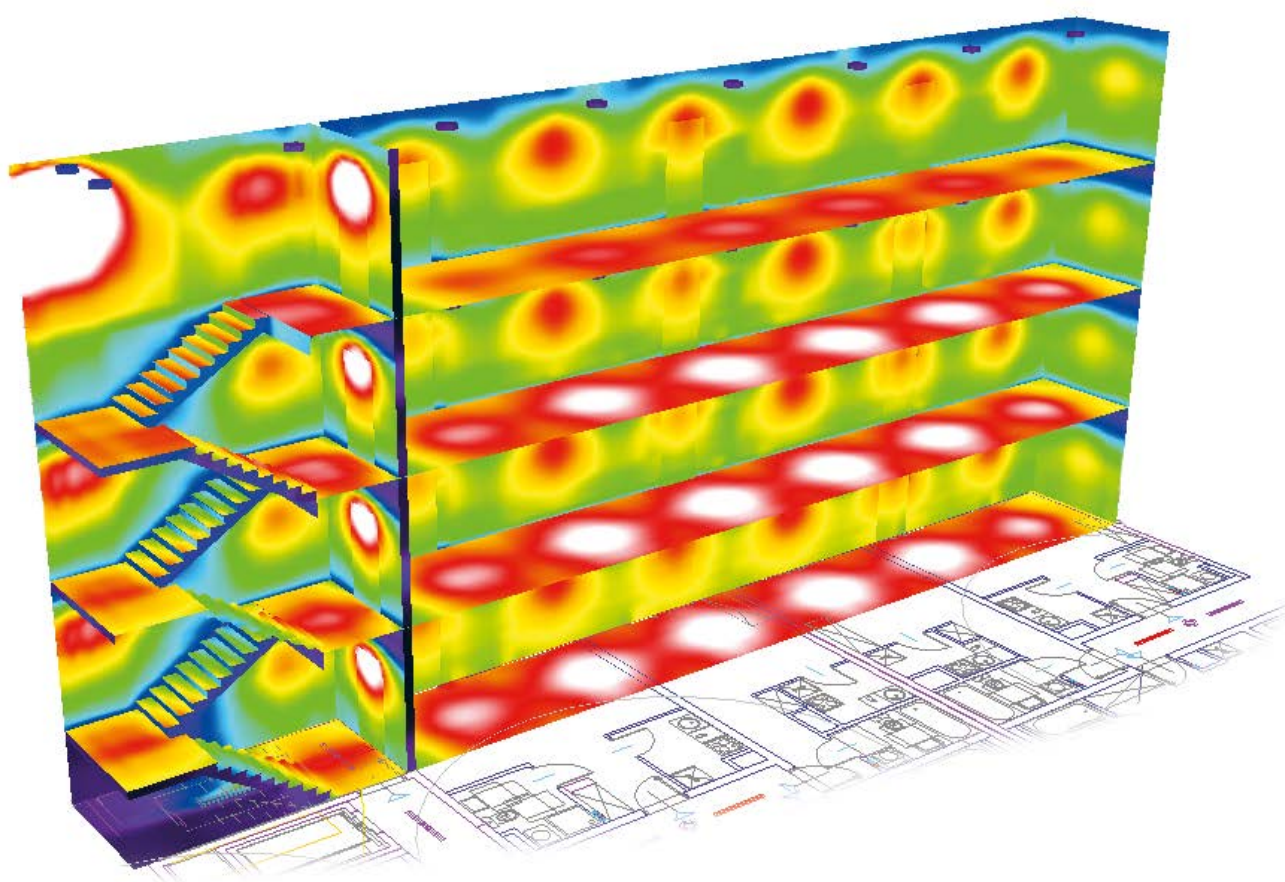

VARIANT A - EVG

- 2x26W EVG FITTING x 55 pcs

VARIANT B - LED

- 24W LED FITTING x 32 pcs

The highest energy efficiency of the office building forced us to maximize light efficiency. At the stage of designing, it was decided that the lighting would be controlled by motion sensors with the system of Master-Slave in both options.

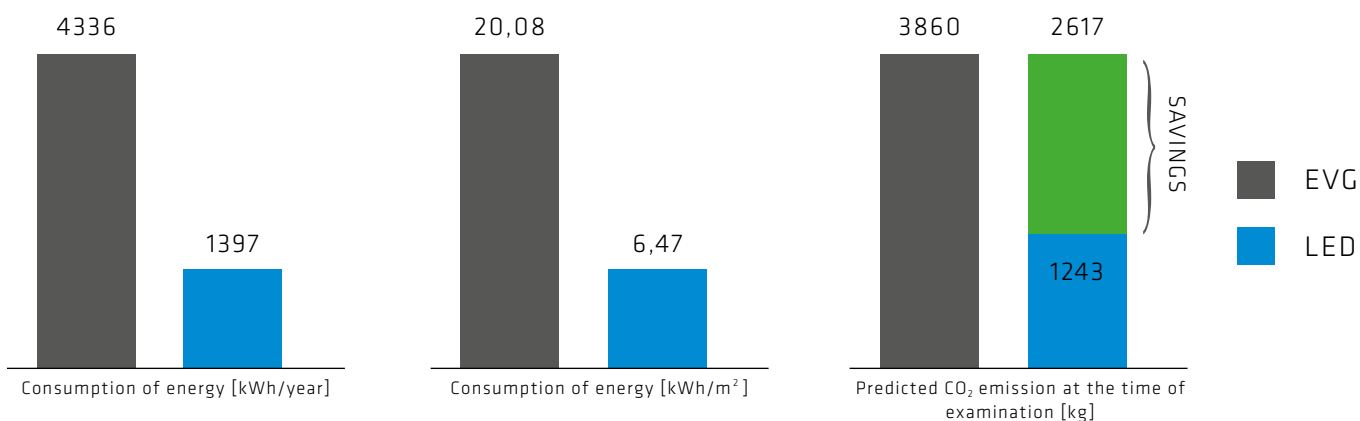

AMORTISATION OF COSTS

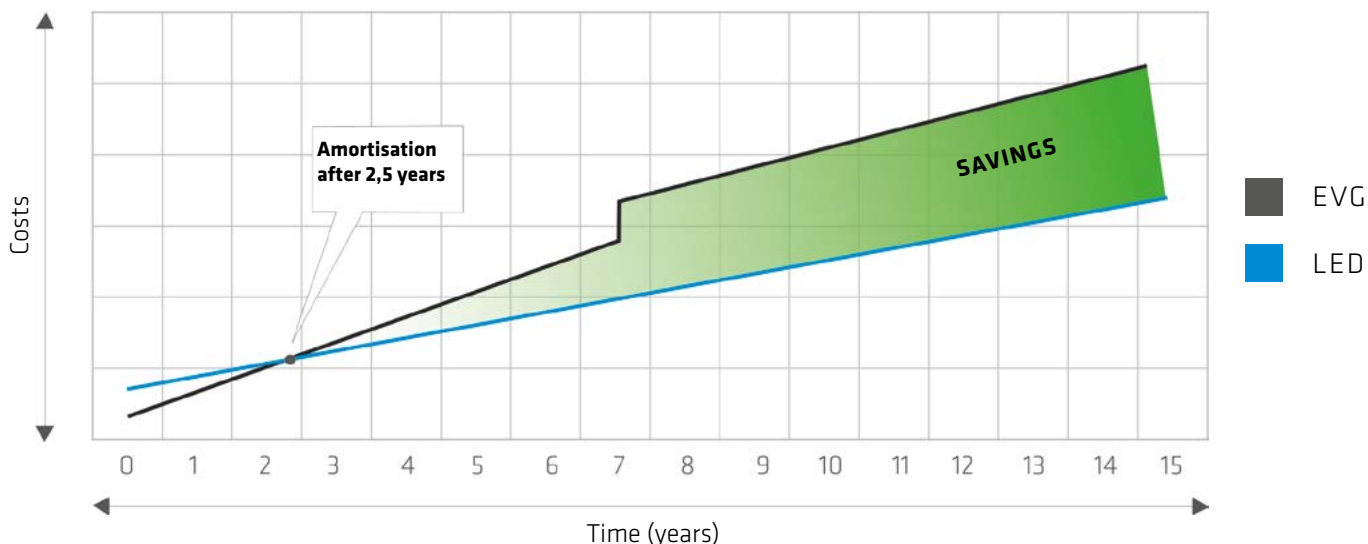

The comparative analysis showed a lot of benefits from using LED fittings. First of all, the estimation proved that the total energy consumption per 1m² is 68% lower for LED fittings than in the case of traditional fluorescent luminaires. The effect was reached not only due to the lower energy consumption by LED fittings but also because of installing smaller amount of fittings themselves.

In addition, what is particularly important for class A office buildings, CO₂ emission was significantly decreased. Considering all the costs of buying and installation, the estimated time for money return from the investment was scheduled to 2,5 year. After this time the Investor will experience constant, dynamic profits' increase thanks to using LED fittings (green colour in the chart of savings).

As the most important values, we can list low costs of energy consumption, lack of the costs connected with replacing the sources and maintenance service.

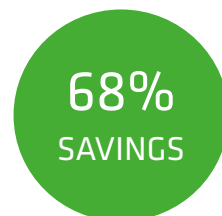

THE BASIC ASSUMPTION OF CASE STUDY

Brightness in LX according to the directives, time of lighting 4h/24 hours, price for 1 kWh - 0,14 EUR; the cost of replacing the light sources on the basis of average market prices.

PROXIMA LED

BULKHEADS

LED GO!



SPECIFICATION

Ingress protection class:	IP65
Impact resistance:	IK10
Total luminous flux*:	max. 2300lm (4000K)
Colour temperature (CCT):	3000K, 4000K
Energy efficiency class (EEI):	A
Power supply:	220-240V / 50-60Hz
Mounting:	surface
Body:	PP
Diffuser:	PC OPAL

Surface mounted, round LED fitting with integrated, energy-saving light source LED GO with high luminous flux and protection class IP65. Body and base made of UV-resistant plastic with. Specially formed diffuser made of impact resistant PC ensures the highest impact resistance of the fitting (IK10). Available in two ring colours: white and silver; optional equipment: radio motion sensor (RCR). Colour temperature 3000K/4000K, CRI>80, life-span of LED 50 000h (L70B50) $t_a = 25^\circ\text{C}$.

LIGHT BEAM CURVES

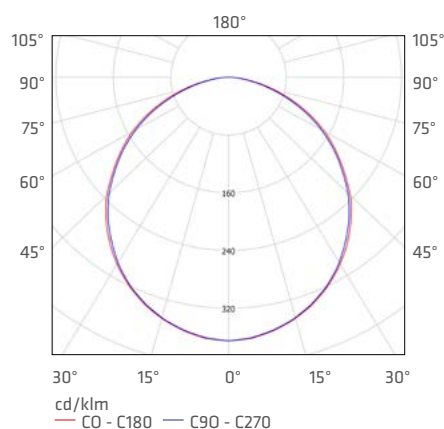

APPLICATION

Surface mounted luminaire, intended for outdoor (facade lighting) or indoor use (rooms with high humidity, passageways). Available option with a radio motion sensor (RCR) - particularly well suited for passageways and usable rooms. The luminaire will also work well as a general light source due to the decorative effect that it provides (indirect light distribution on the mounting surface). Two ring colours available: white or silver.



PROXIMA LED

BULKHEADS

PROXIMA LED WHITE

IP65 | IK10 | 





1,25  1,32  ^{RCR}

rated power [W]	colour temperature [K]	total luminous flux* [lm]	diffuser	sensor	EEL	index
24	3000	2150	OPAL	-	A	311406
24	4000	2300	OPAL	-	A	311420
24	3000	2150	OPAL	RCR	A	311949
24	4000	2300	OPAL	RCR	A	311918

PROXIMA LED SILVER MAT

IP65 | IK10 | 



1,25  1,32  ^{RCR}



rated power [W]	colour temperature [K]	total luminous flux* [lm]	diffuser	sensor	EEL	index
24	3000	2150	OPAL	-	A	311413
24	4000	2300	OPAL	-	A	311437
24	3000	2150	OPAL	RCR	A	311956
24	4000	2300	OPAL	RCR	A	311925

OPTION WITH VANDAL PROTECTION

PROXIMA LED WHITE

IP65 | IK10 | 



1,25  1,32  ^{RCR}

rated power [W]	colour temperature [K]	total luminous flux* [lm]	diffuser	sensor	EEL	index
24	4000	2300	OPAL	-	A	310898
24	4000	2300	OPAL	RCR	A	310850

* Initial, tolerance +/- 10%

Available options: **DALI**.

PHOBOS LED

BULKHEADS

LED GO!



SPECIFICATION

Ingress protection class:	IP20
Total luminous flux*:	max. 3550lm (4000K)
Colour temperature (CCT):	3000K, 4000K
Energy efficiency class (EEI):	A
Power supply:	220-240V / 50-60Hz
Mounting:	surface
Body:	powder coated steel
Diffuser:	PMMA OPAL

Surface mounted, round LED fitting with very high diffuser diameter, high luminous flux and even light distribution. Includes an integrated energy-saving light source LED GO!. Galvanized steel base, powder coated white; light, white acrylic diffuser. Simple pawl-based mounting system does not require any additional tools and safeguards the diffuser against uncontrolled fall. The luminaire may be used to replace standard four-lamp fittings in irregular shaped rooms. Designed to work with a radio motion sensor or the DALI system. Colour temperature 3000K/4000K, CRI>80, lifespan of LED 50 000h (L70B50) $t_a=25^{\circ}\text{C}$.

LIGHT BEAM CURVES

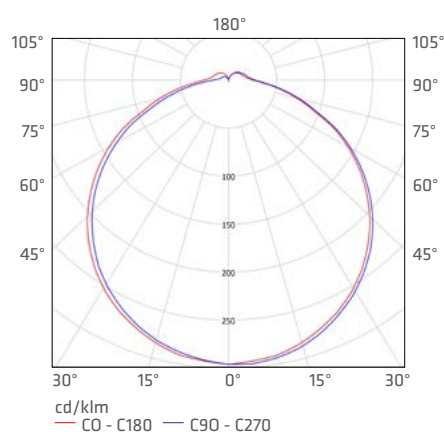

APPLICATION

Surface mounted fitting intended for indoor use characterized by even light distribution and good surface lighting. Particularly suitable as a general light source in representative rooms and passageways. Thanks to exceptional lighting parameters, possible integration with the DALI system and decorative qualities, the product will surely prove its worth in large conference halls.

PHOBOS LED

BULKHEADS

PHOBOS LED

IP20 



Ø 500



110

1,11 KG  1,18 KG  ^{RCR}

rated power [W]	colour temperature [K]	total luminous flux* [lm]	diffuser	sensor	EEL	index
32	3000	2100	OPAL	-	A	470660
32	4000	2250	OPAL	-	A	470608
32	3000	2100	OPAL	RCR	A	470677
32	4000	2250	OPAL	RCR	A	470615
50	3000	3100	OPAL	-	A	470745
50	4000	3550	OPAL	-	A	470639
50	3000	3100	OPAL	RCR	A	470752
50	4000	3350	OPAL	RCR	A	470721

* Initial, tolerance +/- 10%

Available options: **DALI**.

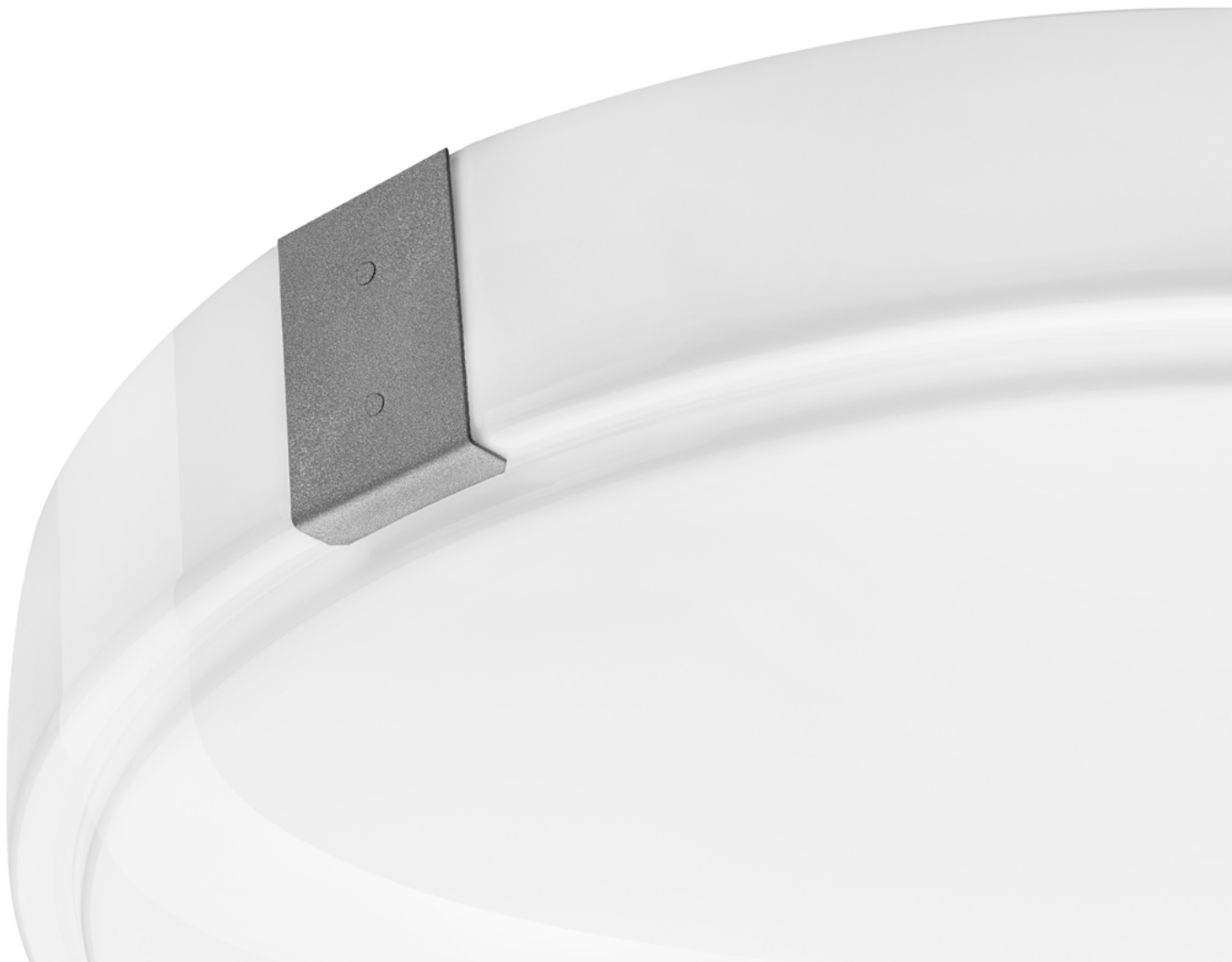

CALLISTO LED

BULKHEADS

LED GO!



SPECIFICATION

Ingress protection class:	IP40
Total luminous flux*:	max. 1500lm (4000K)
Colour temperature (CCT):	3000K, 4000K
Energy efficiency class (EEI):	A
Power supply:	220-240V / 50-60Hz
Mounting:	surface
Body:	galvanized steel
Diffuser:	GLASS OPAL, OPAL MAT

Surface mounted, round LED luminaire with a very high luminous flux includes an integrated energy-saving light source LED GO!. Galvanized steel base, powder coated white; glass diffuser hand-made of multilayer triplex glass which ensures even light distribution. Decorative fitting with an easy-to-clean, simple system mounting the diffuser to the base. Available in four diameters and two finishes: opal and opal mat. Colour temperature 3000K/4000K, CRI>80, lifespan of LED 50 000h (L70B50) $t_a=25^{\circ}\text{C}$.

LIGHT BEAM CURVES

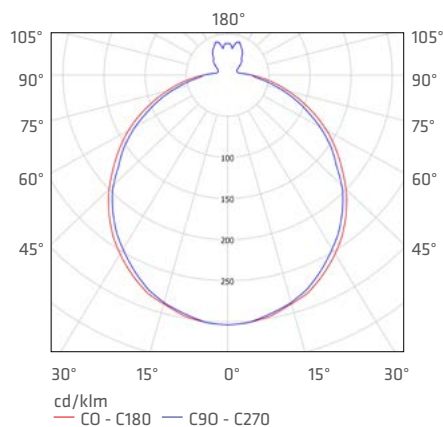

APPLICATION

Surface mounted fitting intended for indoor use in representative rooms and passageways (large conference halls, hotel corridors, studies). Designed for mounting on ceilings and walls. Wide range of diameters and two diffuser versions allow for the same fitting to be used in rooms with different parameters. Well suited to be used as a basic or general interior light source.

CALLISTO LED 260

IP40 



1,15 

rated power [W]	colour temperature [K]	total luminous flux* [lm]	diffuser	EEI	index
8	3000	600	OPAL	A	064005
8	4000	650	OPAL	A	064029
8	3000	550	OPAL MAT	A	064012
8	4000	600	OPAL MAT	A	064036
14	3000	950	OPAL	A	064043
14	4000	1050	OPAL	A	064067
14	3000	850	OPAL MAT	A	064050
14	4000	950	OPAL MAT	A	064074

CALLISTO LED 305

IP40 

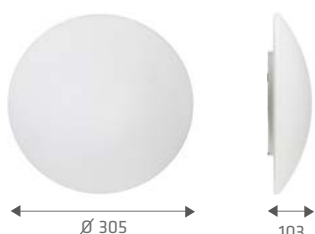

1,60 

rated power [W]	colour temperature [K]	total luminous flux* [lm]	diffuser	EEI	index
8	3000	600	OPAL	A	064258
8	4000	650	OPAL	A	064272
8	3000	550	OPAL MAT	A	064265
8	4000	600	OPAL MAT	A	064289
14	3000	950	OPAL	A	064296
14	4000	1050	OPAL	A	064319
14	3000	850	OPAL MAT	A	064302
14	4000	950	OPAL MAT	A	064326

CALLISTO LED 365

IP40 

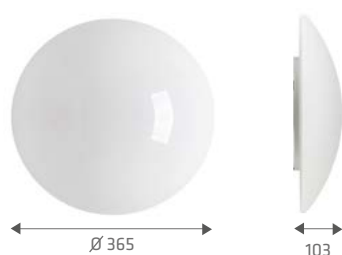

2,30 

rated power [W]	colour temperature [K]	total luminous flux* [lm]	diffuser	EEI	index
14	3000	950	OPAL	A	064609
14	4000	1050	OPAL	A	064623
14	3000	850	OPAL MAT	A	064616
14	4000	950	OPAL MAT	A	064630
20	3000	1400	OPAL	A	064647
20	4000	1500	OPAL	A	064661
20	3000	1200	OPAL MAT	A	064654
20	4000	1350	OPAL MAT	A	064678

CALLISTO LED 420

IP40 

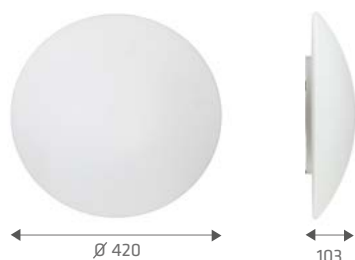

2,50 

rated power [W]	colour temperature [K]	total luminous flux* [lm]	diffuser	EEI	index
14	3000	950	OPAL	A	064807
14	4000	1050	OPAL	A	064821
14	3000	850	OPAL MAT	A	064814
14	4000	950	OPAL MAT	A	064838
20	3000	1400	OPAL	A	064845
20	4000	1500	OPAL	A	064869
20	3000	1200	OPAL MAT	A	064852
20	4000	1350	OPAL MAT	A	064876

* Initial, tolerance +/- 10%



SPECIFICATION

Ingress protection class:	IP65
Impact resistance:	IK08
Total luminous flux*:	max. 1700lm (4000K)
Colour temperature (CCT):	3000K, 4000K
Energy efficiency class (EEI):	A
Power supply:	220-240V / 50-60Hz
Mounting:	surface
Body:	aluminium
Diffuser:	PC OPAL

Surface mounted, round LED luminaire with integrated energy-saving light source LED GO! and increased ingress protection class IP65. Body and base made of high-pressure cast aluminium and powder coated silver or graphite. Specially formed diffuser made of impact resistant PC ensures high impact resistance of the fitting (IK08). Colour temperature 3000K/4000K, CRI>80, lifespan of LED 50 000h (L70B50) $t_a = 25^\circ\text{C}$.

LIGHT BEAM CURVES

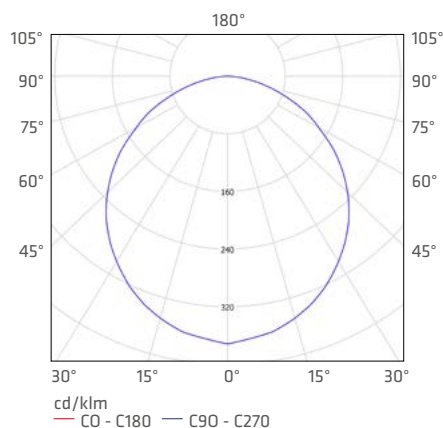

APPLICATION

Surface mounted quick-installation luminaire intended for indoor or outdoor use. Suitable as a general light source in representative rooms and passageways. Very good mechanical parameters (increased ingress protection class IP65 and impact resistance IK08) allow this fitting to be used for facade applications.

GLO LED GRAPHITE

IP65 | IK08 | 

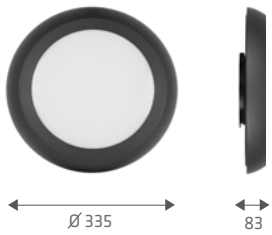

2,24 

rated power [W]	colour temperature [K]	total luminous flux* [lm]	diffuser	EEL	index
9	3000	500	OPAL	A	193705
9	4000	540	OPAL	A	311611
18	3000	840	OPAL	A	193668
18	4000	900	OPAL	A	311512
36	3000	1600	OPAL	A	193682
36	4000	1700	OPAL	A	311505

GLO LED SILVER MAT

IP65 | IK08 | 

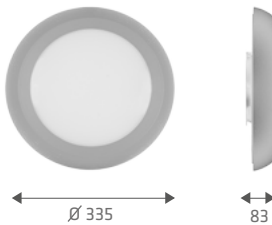

2,24 

rated power [W]	colour temperature [K]	total luminous flux* [lm]	diffuser	EEL	index
9	3000	500	OPAL	A	193712
9	4000	540	OPAL	A	311604
18	3000	840	OPAL	A	193675
18	4000	900	OPAL	A	311581
36	3000	1600	OPAL	A	193699
36	4000	1700	OPAL	A	311574

* Initial, tolerance +/- 10%



TEO LED

BULKHEADS

LED GO!



SPECIFICATION

Ingress protection class:	IP65
Impact resistance:	IK10
Total luminous flux*:	max. 2350lm (4000K)
Colour temperature (CCT):	3000K, 4000K
Energy efficiency class (EEI):	A
Power supply:	220-240V / 50-60Hz
Mounting:	surface
Body:	aluminium
Diffuser:	PC OPAL

Surface mounted, round LED fitting with integrated energy-saving light source LED GO! and increased ingress protection class IP65. Body and base made of high-pressure cast aluminium and powder coated silver or graphite. Specially formed diffuser made of impact resistant PC ensures the highest possible impact resistance of the fitting (IK10). Colour temperature 3000K/4000K, CRI>80, lifespan of LED 50 000h (L70B50) $t_a = 25^\circ\text{C}$.

LIGHT BEAM CURVES

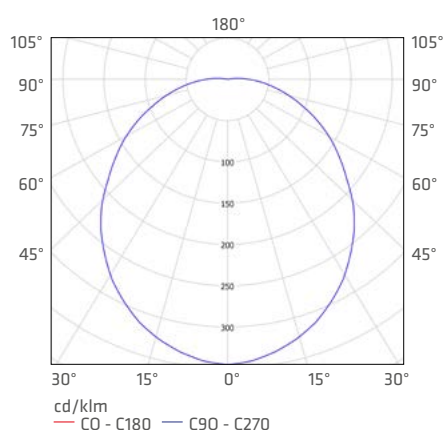

APPLICATION

Surface mounted, quick-installation luminaire intended for indoor or outdoor use. Suitable as a general light source in representative rooms and passageways. Very good mechanical parameters (increased ingress protection class IP65 and impact resistance IK10) allow this fitting to be used for facade applications.

TEO LED GRAPHITE

IP65 | IK10 | 

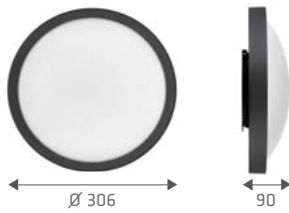

1,78 

rated power [W]	colour temperature [K]	total luminous flux* [lm]	diffuser	EEL	index
9	3000	680	OPAL	A	193644
9	4000	730	OPAL	A	311635
18	3000	1150	OPAL	A	193606
18	4000	1250	OPAL	A	311550
36	3000	2200	OPAL	A	193620
36	4000	2350	OPAL	A	311536

TEO LED SILVER

IP65 | IK10 | 

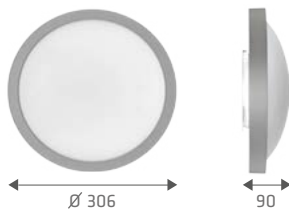

1,78 

rated power [W]	colour temperature [K]	total luminous flux* [lm]	diffuser	EEL	index
9	3000	680	OPAL	A	193651
9	4000	730	OPAL	A	311628
18	3000	1150	OPAL	A	193613
18	4000	1250	OPAL	A	311567
36	3000	2200	OPAL	A	193637
36	4000	2350	OPAL	A	311543

* Initial, tolerance +/- 10%



SATURN LED

BULKHEADS

LED GO!



SPECIFICATION

Ingress protection class:	IP54
Impact resistance:	IK10
Total luminous flux*:	max. 1750lm (4000K)
Colour temperature (CCT):	3000K, 4000K
Energy efficiency class (EEI):	A
Power supply:	220-240V / 50-60Hz
Mounting:	surface
Body:	PP
Diffuser:	PC OPAL

Surface mounted, round LED light fixture with integrated energy-saving light source LED GO!, a high luminous flux and high ingress protection class IP54. Base and ring made of UV-resistant plastic. Specially formed diffuser made of impact resistant PC ensures the highest impact resistance of the fitting (IK10). Available in five ring colours. Optional equipment: radio motion sensor (RCR). Colour temperature 3000K/4000K, CRI>80, lifespan of LED 50 000h (L70B50) $t_a=25^{\circ}\text{C}$.

LIGHT BEAM CURVES

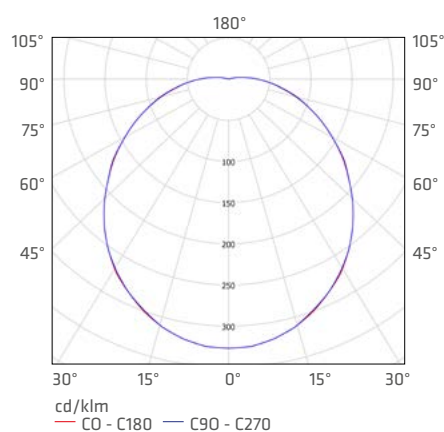

APPLICATION

Luminaire suited for surface mounting on ceilings or walls, intended for outdoor (facade lighting) or indoor use (rooms with high humidity, passageways). Available option with a radio motion sensor (RCR) – particularly well suited for passageways and usable rooms.



SATURN LED

BULKHEADS

SATURN LED WHITE

IP54 | IK10 | 





1,15  1,22  ^{RCR}

rated power [W]	colour temperature [K]	total luminous flux* [lm]	diffuser	sensor	EEL	index
9	3000	800	OPAL	-	A	063596
9	4000	870	OPAL	-	A	063503
9	3000	800	OPAL	RCR	A	185762
9	4000	870	OPAL	RCR	A	185151
14	3000	1300	OPAL	-	A	185342
14	4000	1400	OPAL	-	A	185397
14	3000	1300	OPAL	RCR	A	185922
14	4000	1400	OPAL	RCR	A	063404
18	3000	1650	OPAL	-	A	068782
18	4000	1750	OPAL	-	A	068775
18	3000	1650	OPAL	RCR	A	068744
18	4000	1750	OPAL	RCR	A	068737

SATURN LED BLACK

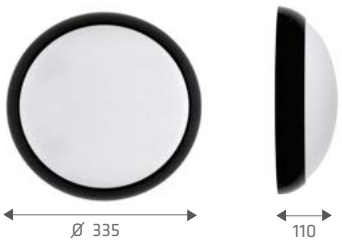
IP54 | IK10 | 





1,15  1,22  ^{RCR}

rated power [W]	colour temperature [K]	total luminous flux* [lm]	diffuser	sensor	EEL	index
9	3000	800	OPAL	-	A	185816
9	4000	870	OPAL	-	A	063435
9	3000	800	OPAL	RCR	A	185779
9	4000	870	OPAL	RCR	A	185168
14	3000	1300	OPAL	-	A	185335
14	4000	1400	OPAL	-	A	185380
14	3000	1300	OPAL	RCR	A	185939
14	4000	1400	OPAL	RCR	A	063428
18	3000	1650	OPAL	-	A	068416
18	4000	1750	OPAL	-	A	068430

SATURN LED SILVER MAT

IP54 | IK10 | 



1,15  1,22  ^{RCR}

rated power [W]	colour temperature [K]	total luminous flux* [lm]	diffuser	sensor	EEL	index
9	3000	800	OPAL	-	A	185823
9	4000	870	OPAL	-	A	063442
9	3000	800	OPAL	RCR	A	185786
9	4000	870	OPAL	RCR	A	185175
14	3000	1300	OPAL	-	A	185328
14	4000	1400	OPAL	-	A	185373
14	3000	1300	OPAL	RCR	A	185946
14	4000	1400	OPAL	RCR	A	063510

* Initial, tolerance +/- 10%

SATURN LED

BULKHEADS

SATURN LED SILVER

IP54 | IK10 | 



1,15  1,22  ^{RCR}

rated power [W]	colour temperature [K]	total luminous flux* [lm]	diffuser	sensor	EEl	index
9	3000	800	OPAL	-	A	185830
9	4000	870	OPAL	-	A	063411
9	3000	800	OPAL	RCR	A	185793
9	4000	870	OPAL	RCR	A	185182
14	3000	1300	OPAL	-	A	185311
14	4000	1400	OPAL	-	A	185366
14	3000	1300	OPAL	RCR	A	185953
14	4000	1400	OPAL	RCR	A	063527

SATURN LED GOLD

IP54 | IK10 | 

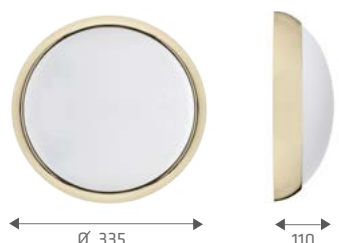

1,15  1,22  ^{RCR}

rated power [W]	colour temperature [K]	total luminous flux* [lm]	diffuser	sensor	EEl	index
9	3000	800	OPAL	-	A	185847
9	4000	870	OPAL	-	A	063459
9	3000	800	OPAL	RCR	A	185809
9	4000	870	OPAL	RCR	A	185199
14	3000	1300	OPAL	-	A	185304
14	4000	1400	OPAL	-	A	185359
14	3000	1300	OPAL	RCR	A	185960
14	4000	1400	OPAL	RCR	A	063534

OPTION WITH CORRIDOR FUNCTION

(10%-100% light stream)

SATURN LED WHITE

IP54 | IK10 | 



1,22 

rated power [W]	colour temperature [K]	total luminous flux* [lm]	diffuser	sensor	EEl	index
14/1,5	3000	1300/170	OPAL	CORRIDOR	A	068805
14/1,5	4000	1400/190	OPAL	CORRIDOR	A	068799
18/2	3000	1650/170	OPAL	CORRIDOR	A	068942
18/2	4000	1750/190	OPAL	CORRIDOR	A	068928

* Initial, tolerance +/- 10%



OPTION WITH VANDAL PROTECTION

SATURN LED WHITE

IP54 | IK10 | 

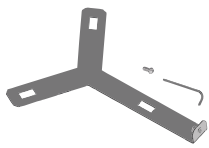
rated power [W]	colour temperature [K]	total luminous flux* [lm]	diffuser	sensor	EEL	index
14	4000	1400	OPAL	-	A	068904
14	4000	1400	OPAL	RCR	A	068249
18	4000	1750	OPAL	-	A	069970
18	4000	1750	OPAL	RCR	A	068478



1,15 KG  1,22 KG 

* Initial, tolerance +/- 10%



MERCURY LED

BULKHEADS

LED GO!



SPECIFICATION

Ingress protection class:	IP54
Impact resistance:	IK10
Total luminous flux*:	max. 750lm (4000K)
Colour temperature (CCT):	3000K, 4000K
Energy efficiency class (EEI):	A
Power supply:	220-240V / 50-60Hz
Mounting:	surface
Body:	PP
Diffuser:	PC OPAL

Surface mounted, round LED light fixture with integrated energy-saving light source LED GO!, a high luminous flux and high ingress protection class IP54. Base and ring made of UV-resistant plastic. Specially formed diffuser made of impact resistant PC ensures the highest impact resistance of the fitting (IK10). Available in white. Optional equipment: radio motion sensor (RCR). Colour temperature 3000K/4000K, CRI>80, lifespan of LED 50 000h (L70B50) $t_a = 25^\circ\text{C}$.

LIGHT BEAM CURVES

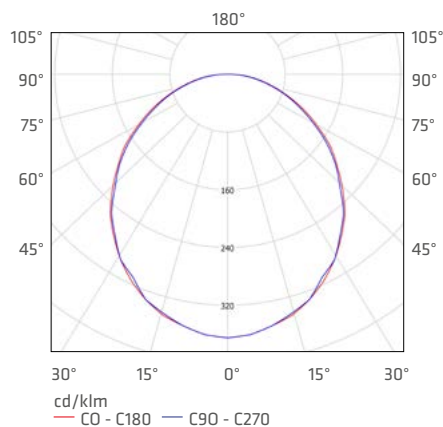

APPLICATION

Luminaire suited for surface mounting on ceilings or walls, intended for outdoor (facade lighting) or indoor use (rooms with high humidity, passageways). Available option with a radio motion sensor (RCR) – particularly well suited for passageways and usable rooms.

MERCURY LED

BULKHEADS

MERCURY LED

IP54 | IK10 | 



* Initial, tolerance +/- 10%

0,55  KG 0,62  KG ^{RGR}

rated power [W]	colour temperature [K]	total luminous flux* [lm]	diffuser	sensor	EEL	index
8	3000	700	OPAL	-	A	187230
8	4000	750	OPAL	-	A	187216
8	3000	700	OPAL	RCR	A	187209
8	4000	750	OPAL	RCR	A	187223



CAMEA LED EVO

BULKHEADS

LED GO!



SPECIFICATION

Ingress protection class:	IP44
Impact resistance:	IK10
Total luminous flux*:	max. 2100lm (4000K)
Colour temperature (CCT):	3000K, 4000K
Energy efficiency class (EEI):	A+
Power supply:	220-240V / 50-60Hz
Mounting:	surface
Body:	PP
Diffuser:	PC OPAL

Surface mounted, round LED light fixture with integrated energy-saving light source LED GO!, a high luminous flux and high ingress protection class IP44. Base and ring made of UV-resistant plastic. Specially formed diffuser made of impact resistant PC ensures the highest impact resistance of the fitting (IK10). Available in five ring colours. Optional equipment: radio motion sensor (RCR). Colour temperature 3000K/4000K, CRI>80, lifespan of LED 50 000h (L70B50) $t_a= 25\text{ }^\circ\text{C}$.

LIGHT BEAM CURVES

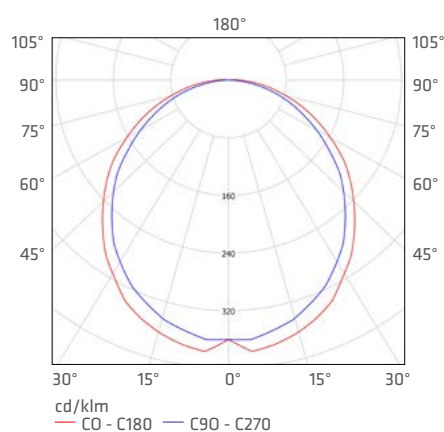

APPLICATION

Luminaire suited for surface mounting on ceilings or walls, intended for indoor use (usable rooms, staircases, passageways). Available option with a radio motion sensor (RCR) - particularly well suited for passageways and usable rooms.



CAMEA LED EVO

BULKHEADS

CAMEA LED EVO WHITE

IP44 | IK10 | 



0,60  0,67 

rated power [W]	colour temperature [K]	total luminous flux* [lm]	diffuser	sensor	EEL	index
10	3000	970	OPAL	-	A+	205002
10	4000	1040	OPAL	-	A+	205019
10	3000	970	OPAL	RCR	A+	205156
10	4000	1040	OPAL	RCR	A+	205163
11	3000	1090	OPAL	-	A+	205620
11	4000	1180	OPAL	-	A+	205637
11	3000	1090	OPAL	RCR	A+	205644
11	4000	1180	OPAL	RCR	A+	205651
20	3000	1950	OPAL	-	A+	205231
20	4000	2100	OPAL	-	A+	205248
20	3000	1950	OPAL	RCR	A+	205316
20	4000	2100	OPAL	RCR	A+	205323

CAMEA LED EVO SATIN

IP44 | IK10 | 

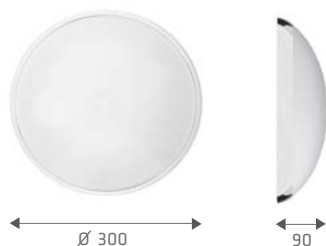



0,60  0,67 

rated power [W]	colour temperature [K]	total luminous flux* [lm]	diffuser	sensor	EEL	index
10	3000	970	OPAL	-	A+	205545
10	4000	1040	OPAL	-	A+	205552
10	3000	970	OPAL	RCR	A+	205569
10	4000	1040	OPAL	RCR	A+	205576
11	3000	1090	OPAL	-	A+	205743
11	4000	1180	OPAL	-	A+	205750
11	3000	1090	OPAL	RCR	A+	205767
11	4000	1180	OPAL	RCR	A+	205774
20	3000	1950	OPAL	-	A+	205583
20	4000	2100	OPAL	-	A+	205590
20	3000	1950	OPAL	RCR	A+	205606
20	4000	2100	OPAL	RCR	A+	205613

CAMEA LED EVO SILVER

IP44 | IK10 | 



0,60  0,67 

rated power [W]	colour temperature [K]	total luminous flux* [lm]	diffuser	sensor	EEL	index
10	3000	970	OPAL	-	A+	205040
10	4000	1040	OPAL	-	A+	205057
10	3000	970	OPAL	RCR	A+	205194
10	4000	1040	OPAL	RCR	A+	205200
11	3000	1090	OPAL	-	A+	205705
11	4000	1180	OPAL	-	A+	205712
11	3000	1090	OPAL	RCR	A+	205729
11	4000	1180	OPAL	RCR	A+	205736
20	3000	1950	OPAL	-	A+	205279
20	4000	2100	OPAL	-	A+	205286
20	3000	1950	OPAL	RCR	A+	205354
20	4000	2100	OPAL	RCR	A+	205361

* Initial, tolerance +/- 10%
Available options: **GOLD** ring colour.

CAMEA LED

BULKHEADS

LED GO!



SPECIFICATION

Ingress protection class:	IP44
Impact resistance:	IK10
Total luminous flux*:	max. 1550lm (4000K)
Colour temperature (CCT):	3000K, 4000K
Energy efficiency class (EEI):	A
Power supply:	220-240V / 50-60Hz
Mounting:	surface / wall
Body:	PP
Diffuser:	PC OPAL

Surface mounted, round LED light fixture with integrated energy-saving light source LED GO!, a high luminous flux and high ingress protection class IP44. Base and ring made of UV-resistant plastic. Specially formed diffuser made of impact resistant PC ensures the highest impact resistance of the fitting (IK10). Available in five ring colours. Optional equipment: radio motion sensor (RCR). Colour temperature 3000K/4000K, CRI>80, lifespan of LED 50 000h (L70B50) $t_a= 25\text{ }^\circ\text{C}$.

LIGHT BEAM CURVES

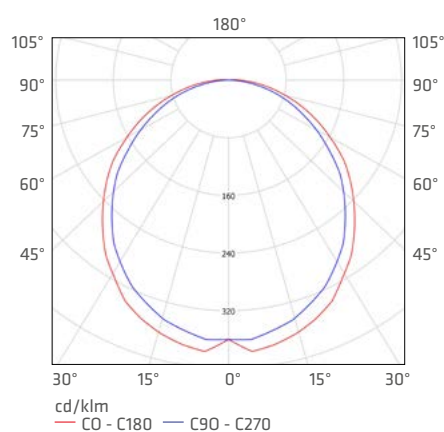

APPLICATION

Luminaire suited for surface mounting on ceilings or walls, intended for indoor use (usable rooms, staircases, passageways). Available option with a radio motion sensor (RCR) - particularly well suited for passageways and usable rooms.

CAMEA LED WHITE

IP44 | IK10 | 



0,94  KG

rated power [W]	colour temperature [K]	total luminous flux* [lm]	diffuser	sensor	EEL	index
9	3000	740	OPAL	-	A	063046
9	4000	800	OPAL	-	A	063015
9	3000	740	OPAL	RCR	A	063879
9	4000	800	OPAL	RCR	A	063251
12	3000	1050	OPAL	-	A	066061
12	4000	1140	OPAL	-	A	066016
12	3000	1050	OPAL	RCR	A	063893
12	4000	1140	OPAL	RCR	A	063886
16	3000	1400	OPAL	-	A	066184
16	4000	1550	OPAL	-	A	066177
16	3000	1400	OPAL	RCR	A	066139
16	4000	1550	OPAL	RCR	A	066122

CAMEA LED SILVER

IP44 | IK10 | 

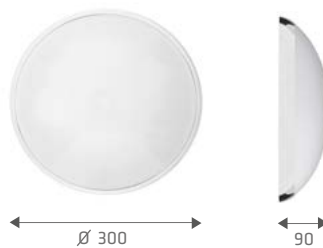

0,94  KG

rated power [W]	colour temperature [K]	total luminous flux* [lm]	diffuser	sensor	EEL	index
9	3000	740	OPAL	-	A	063176
9	4000	800	OPAL	-	A	063138
9	3000	740	OPAL	RCR	A	067853
9	4000	800	OPAL	RCR	A	063237
12	3000	1050	OPAL	-	A	066085
12	4000	1140	OPAL	-	A	066030
12	3000	1050	OPAL	RCR	A	067815
12	4000	1140	OPAL	RCR	A	142628

CAMEA LED SILVER MAT

IP44 | IK10 | 



0,94  KG

rated power [W]	colour temperature [K]	total luminous flux* [lm]	diffuser	sensor	EEL	index
9	3000	740	OPAL	-	A	063268
9	4000	800	OPAL	-	A	063497
9	3000	740	OPAL	RCR	A	067860
9	4000	800	OPAL	RCR	A	063206
12	3000	1050	OPAL	-	A	066092
12	4000	1140	OPAL	-	A	066047
12	3000	1050	OPAL	RCR	A	067822
12	4000	1140	OPAL	RCR	A	142635

CAMEA LED

BULKHEADS

CAMEA LED GOLD

IP44 | IK10 | 



0,94  KG

rated power [W]	colour temperature [K]	total luminous flux* [lm]	diffuser	sensor	EEl	index
9	3000	740	OPAL	-	A	063107
9	4000	800	OPAL	-	A	063077
9	3000	740	OPAL	RCR	A	067877
9	4000	800	OPAL	RCR	A	063244
12	3000	1050	OPAL	-	A	066108
12	4000	1140	OPAL	-	A	066054
12	3000	1050	OPAL	RCR	A	067839
12	4000	1140	OPAL	RCR	A	142611

LED LUMINAIRE WITH CORRIDOR FUNCTION (10%-100% light stream)

CAMEA LED WHITE

IP44 | IK10 | 



0,94  KG

power [W]	colour temperature [K]	total luminous flux* [lm]	diffuser	sensor	type	EEl	index
12/2	3000	1000	OPAL	RCR	alternate	A	066207
12/2	4000	1140	OPAL	RCR	alternate	A	066191
16/2	3000	1400	OPAL	RCR	alternate	A	066221
16/2	4000	1550	OPAL	RCR	alternate	A	066214





CAMEA PRO LED EVO

BULKHEADS

LED GO!



SPECIFICATION

Ingress protection class:	IP44
Impact resistance:	IK10
Total luminous flux*:	max. 2100lm (4000K)
Colour temperature (CCT):	3000K, 4000K
Energy efficiency class (EEL):	A+
Power supply:	220-240V / 50-60Hz
Mounting:	surface
Body:	PP
Diffuser:	PC OPAL

Surface mounted round LED bulkhead with integrated, energy- saving light source LED GO!, high luminous flux and ingress protection class IP44 . Base and ring made of UV-resistant plastic. Specially formed diffuser made of impact resistant PC ensures the highest impact resistance of the fitting (IK10). The luminaire made in an anti-theft version with an additional protective ring, which is available in two colours. Available option with a radio motion sensor (RCR). Specification: colour temperature 3000K; CRI>80; lifespan of LED panels 50 000 hours (L70B50) $t_a = 25^\circ\text{C}$

LIGHT BEAM CURVES

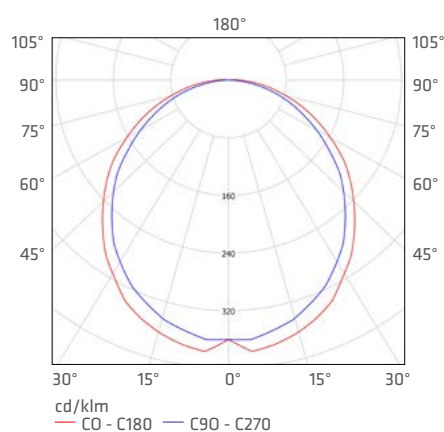

APPLICATION

Surface mounted luminaire for ceiling or wall installation, dedicated for indoor use - in general utility rooms, passageways, staircases. Available option with a radio motion sensor (RCR), which is particularly recommended for use in public areas.

CAMEA PRO LED EVO

BULKHEADS

CAMEA PRO LED EVO WHITE

IP44 | IK10 | 



Ø 300



90

0,60 KG  0,67 KG  ^{RCR}

rated power [W]	colour temperature [K]	total luminous flux* [lm]	diffuser	sensor	EEL	index
10	3000	970	OPAL	-	A+	206009
10	4000	1040	OPAL	-	A+	206016
10	3000	970	OPAL	RCR	A+	206122
10	4000	1040	OPAL	RCR	A+	206139
11	3000	1090	OPAL	-	A+	206047
11	4000	1180	OPAL	-	A+	206054
11	3000	1090	OPAL	RCR	A+	206160
11	4000	1180	OPAL	RCR	A+	206177
20	3000	1950	OPAL	-	A+	206085
20	4000	2100	OPAL	-	A+	206092
20	3000	1950	OPAL	RCR	A+	206207
20	4000	2100	OPAL	RCR	A+	206214

* Initial, tolerance +/- 10%



ORBIT LED

BULKHEADS

LED GO!



SPECIFICATION

Ingress protection class:	IP54	Surface mounted, round LED light fixture with integrated energy-saving light source LED GO!, a high luminous flux, and high ingress protection class IP54. White base; diffuser made of impact resistant PC provides even light distribution and ensures a high impact resistance class (IK10). Colour temperature 4000K, CRI>80, lifespan of LED 50 000h (L70B50) $t_a=25^{\circ}\text{C}$.
Impact resistance:	IK10	
Total luminous flux*:	890lm (4000K)	
Colour temperature (CCT):	3000K, 4000K	
Energy efficiency class (EEI):	A+, A	
Power supply:	220-240V / 50-60Hz	
Mounting:	surface	
Body:	PP	
Diffuser:	PC OPAL	

LIGHT BEAM CURVES

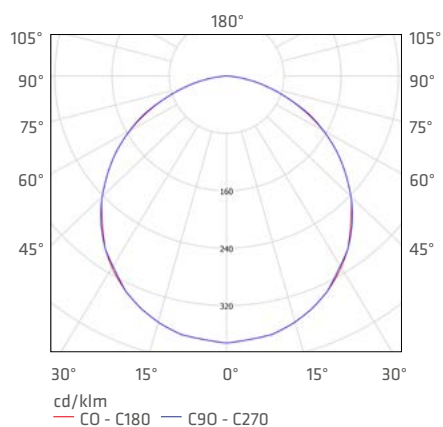

APPLICATION

Luminaire suited for surface mounting on ceilings or walls, intended for outdoor (facade lighting) or indoor use (rooms with high humidity, staircases, passageways). Particularly well suited for usable rooms and multi-family housing buildings.

ORBIT LED

BULKHEADS

ORBIT LED

IP54 | IK10 | 

rated power [W]	colour temperature [K]	total luminous flux* [lm]	diffuser	sensor	EEL	index
9	3000	830	OPAL	-	A	349287
9	4000	890	OPAL	-	A+	349249
9	3000	830	OPAL	RCR	A	349294
9	4000	890	OPAL	RCR	A+	349256



* Initial, tolerance +/- 10%

Available options: **CORRIDOR FUNCTION** (25%-100% light stream).



DISC LED

BULKHEADS

LED GO!



SPECIFICATION

Ingress protection class:	IP54
Impact resistance:	IK10
Total luminous flux*:	max. 800lm (4000K)
Colour temperature (CCT):	3000K, 4000K
Energy efficiency class (EEI):	A
Napięcie zasilania:	220-240V / 50-60Hz
Mounting:	surface
Body:	PC
Diffuser:	PC OPAL

Surface mounted, round LED light fixture with integrated energy-saving light source LED GO!, a high luminous flux, and high ingress protection class IP54. White base; diffuser made of impact resistant PC provides even light distribution and ensures a high impact resistance class (IK10). Colour temperature 3000K/4000K, CRI>80, lifespan of LED 50 000h (L70B50) $t_a = 25^\circ\text{C}$.

LIGHT BEAM CURVES

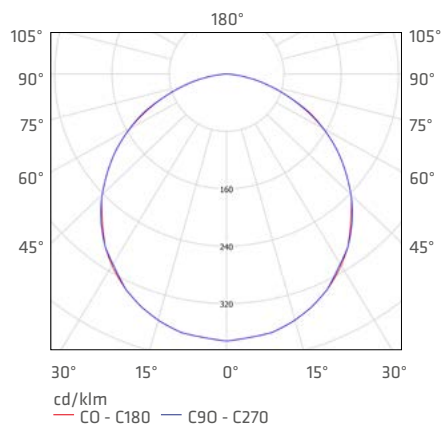

APPLICATION

Luminaire suited for surface mounting on ceilings or walls, intended for outdoor (facade lighting) or indoor use (rooms with high humidity, staircases, passageways). Particularly well suited for usable rooms and multi-family housing buildings.

DISC LED

BULKHEADS

DISC LED

IP54 | IK10 | 

rated
power [W]

colour
temperature [K]

total luminous
flux* [lm]

diffuser

EEL

index

10

3000

750

OPAL

A

346507

10

4000

800

OPAL

A

346514



Ø 220



75

0,88 KG 

* Initial, tolerance +/- 10%





SPECIFICATION

Ingress protection class:	IP54
Impact resistance:	IK10
Total luminous flux*:	max. 900lm (4000K)
Colour temperature (CCT):	3000K, 4000K
Energy efficiency class (EEI):	A
Power supply:	220-240V / 50-60Hz
Mounting:	surface
Body:	PC
Diffuser:	PC OPAL

Surface mounted round bulkhead with built-in integrated, energy-saving light source LED GO!, high luminous flux and increased ingress protection class IP54. Base (available in white) and evenly illuminated diffuser made of impact-resistant PC ensure the highest impact resistance of the fitting (IK10). Specification: colour temperature 3000K, 4000K; CRI>80; lifespan of LED panels 50 000 hours (L70B50) $t_a = 25^{\circ}\text{C}$

LIGHT BEAM CURVES

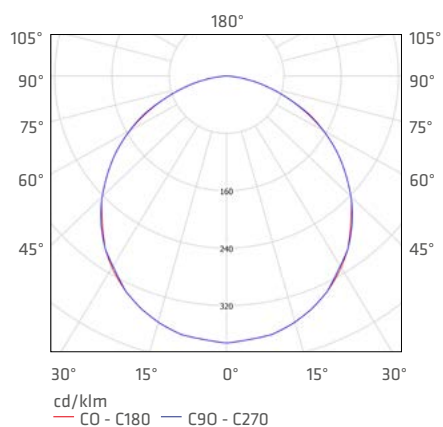

APPLICATION

Luminaire suited for surface mounting on ceilings or walls, intended for indoor use in rooms with high humidity, passageways, staircases or outdoor use as facade lighting. It is particularly recommended for public buildings and multi-family housing.

IZAR LED

IP54 | IK10 | 

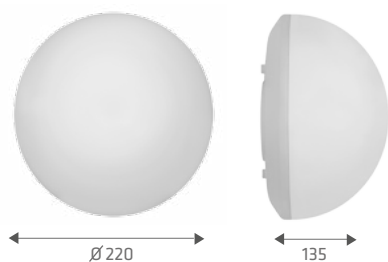

0,50 KG 

rated power [W]	colour temperature [K]	total luminous flux* [lm]	diffuser	EEI	index
10	3000	840	OPAL	A	346705
10	4000	900	OPAL	A	346699

* Initial, tolerance +/- 10%



CORAL LED

BULKHEADS

LED GO!



SPECIFICATION

Ingress protection class:	IP44
Impact resistance:	IK10
Total luminous flux*:	max. 970lm (4000K)
Colour temperature (CCT):	3000K, 4000K
Energy efficiency class (EEI):	A
Power supply:	220-240V / 50-60Hz
Mounting:	surface, recessed (bracket for recessed mounting included)
Body:	PP
Diffuser:	PC OPAL

Surface and recessed mounted round LED for ceiling or wall mounting with a high ingress protection class IP44 and high impact resistance class (IK10). Integrated design for easy installation. Surface-mounted luminaire allows cable termination. The unique design allows replacement of the LED GO! (light source) module without having to replace the entire luminaire. Available in three ring colours. Optional equipment: radio motion sensor (RCR). The product is a registered community design. Colour temperature 3000K/4000K, CRI>80, lifespan of LED 50 000h (L70B50) $t_a = 25^\circ\text{C}$.

LIGHT BEAM CURVES

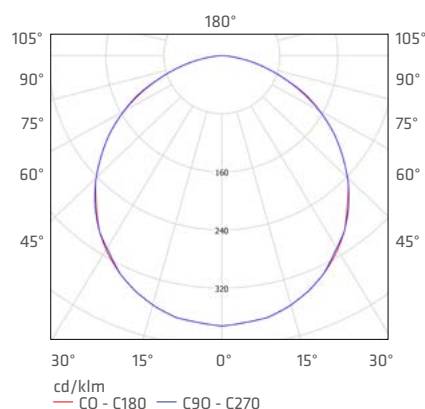

APPLICATION

Luminaire intended for indoor use, well suited for rooms with high humidity and passageways.

CORAL LED WHITE

IP44 | IK10 | 



Ø 260

108

0,64 

0,71 
RCR

rated power [W]	colour temperature [K]	total luminous flux* [lm]	diffuser	sensor	EEL	index
10	3000	850	OPAL	-	A	229855
10	4000	920	OPAL	-	A	229862
10	3000	850	OPAL	RCR	A	229893
10	4000	920	OPAL	RCR	A	229909

CORAL LED SILVER MAT

IP44 | IK10 | 

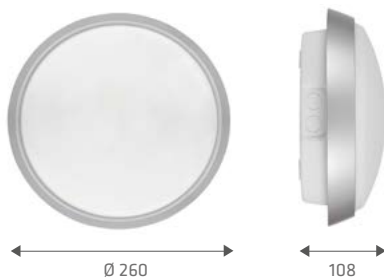

Ø 260

108

0,64 

0,71 
RCR

rated power [W]	colour temperature [K]	total luminous flux* [lm]	diffuser	sensor	EEL	index
10	3000	850	OPAL	-	A	225635
10	4000	920	OPAL	-	A	225642
10	3000	850	OPAL	RCR	A	225673
10	4000	920	OPAL	RCR	A	225680

CORAL LED

IP44 | IK10 | 

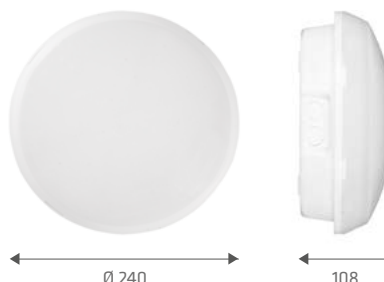

Ø 240

108

0,55 

0,62 
RCR

rated power [W]	colour temperature [K]	total luminous flux* [lm]	diffuser	sensor	EEL	index
10	3000	900	OPAL	-	A	229794
10	4000	970	OPAL	-	A	229725
10	3000	900	OPAL	RCR	A	229817
10	4000	970	OPAL	RCR	A	229749

* Initial, tolerance +/- 10%

CORAL LED

BULKHEADS

RECESSED MOUNTING:

CORAL LED

IP44 | IK10 | 

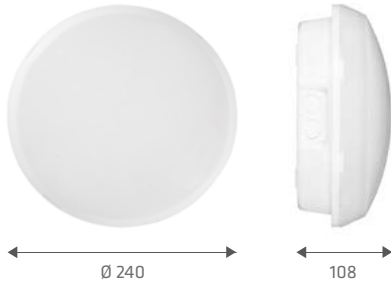

Ø 240

108

0,66  KG

0,73  KG
RCR

Hole diameter (in recessed mounting) = 220mm,
depth = min. 120mm 

rated power [W]	colour temperature [K]	total luminous flux* [lm]	diffuser	sensor	EEL	index
10	3000	900	OPAL	-	A	229800
10	4000	970	OPAL	-	A	229732
10	3000	900	OPAL	RCR	A	229824
10	4000	970	OPAL	RCR	A	229756



Bracket for recessed mounting included

* Initial, tolerance +/- 10%

TECHNICAL DETAILS



Suspended mounting board allows quick installation.



Removable mounting board available on request as a service kit.



Through-wiring connection



Holes for connection with surface installation, through-wiring possible.

ACCESSORIES

index	article name
229763	bracket for recessed mounting
229770	service kit 10W 4000K
229787	service kit 10W RCR (motion sensor) 4000K
229831	service kit 10W 3000K
229848	service kit 10W RCR (motion sensor) 3000K
80000258	trimm WHITE
80000259	trimm BLACK
80000260	trimm SATINE



Bracket for recessed mounting (229763)



SQUARE LED

BULKHEADS

LED GO!



SPECIFICATION

Ingress protection class:	IP54
Impact resistance:	IK08
Total luminous flux*:	max. 950lm (4000K)
Colour temperature (CCT):	3000K, 4000K
Energy efficiency class (EEI):	A
Power supply:	220-240V / 50-60Hz
Mounting:	surface
Body:	PC
Diffuser:	PC OPAL

Surface mounted, square LED light fixture with integrated energy-saving light source LED GO!, a high luminous flux, and high ingress protection class IP54. White base; diffuser made of impact resistant PC provides even light distribution and ensures a high impact resistance class (IK08). Available version with a radio motion sensor (RCR). Colour temperature 3000K/4000K, CRI>80, lifespan of LED 50 000h (L70B50) $t_a = 25\text{ }^\circ\text{C}$.

LIGHT BEAM CURVES

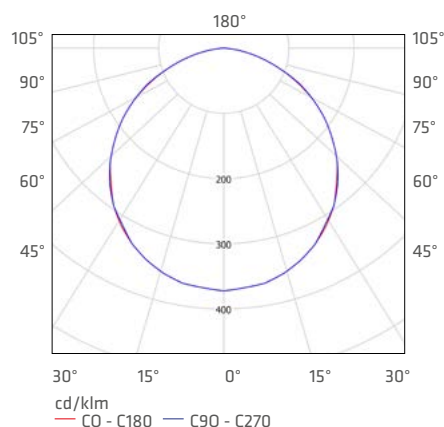

APPLICATION

Luminaire suited for surface mounting on ceilings or walls, intended for outdoor (facade lighting) or indoor use (rooms with high humidity, staircases, passageways). The version with a radio motion sensor (RCR) is particularly well suited for usable rooms and multi-family housing buildings.



SQUARE LED

BULKHEADS

SQUARE LED

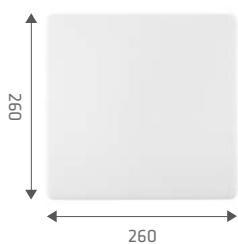
IP54 | IK08 | 



0,75  KG 0,82  KG ^{RCR}

rated power [W]	colour temperature [K]	total luminous flux* [lm]	diffuser	sensor	EEL	index
8	3000	720	OPAL	-	A	190513
8	4000	780	OPAL	-	A	190520
8	3000	720	OPAL	RCR	A	190537
8	4000	780	OPAL	RCR	A	190544
12	3000	850	OPAL	-	A	189043
12	4000	950	OPAL	-	A	189036
12	3000	850	OPAL	RCR	A	189067
12	4000	950	OPAL	RCR	A	189050

* Initial, tolerance +/- 10%



QUADRO LED

BULKHEADS

LED GO!



123..
included

SPECIFICATION

Ingress protection class:	IP54
Impact resistance:	IK08
Total luminous flux*:	max. 510lm (4000K)
Colour temperature (CCT):	3000K, 4000K
Energy efficiency class (EEL):	A
Power supply:	220-240V / 50-60Hz
Mounting:	surface
Body:	PC
Diffuser:	PC OPAL

Surface mounted, square LED light fixture, ingress protection class IP54 and an integrated energy-saving light source LED GO!. White base; diffuser made of impact resistant PC provides even light distribution and ensures a high impact resistance class (IK08). Colour temperature 3000K/4000K, CRI>80, lifespan of LED 50 000h (L70B50) $t_a = 25^\circ\text{C}$.

LIGHT BEAM CURVES

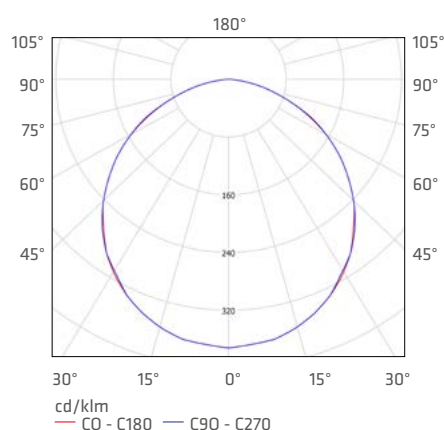

APPLICATION

Surface mounted luminaire for mounting on ceilings and walls; intended for indoor use (rooms with high humidity, passageways, staircases) as well as outdoor use (facade lighting). Recommended particularly for civic buildings and apartment buildings.

QUADRO LED

IP54 | IK08 | 



0,34 

rated power [W]	colour temperature [K]	total luminous flux* [lm]	diffuser	EEL	index
2	3000	140	OPAL	A	191510
2	4000	180	OPAL	A	191503
6	3000	400	OPAL	A	191534
6	4000	510	OPAL	A	191527

* Initial, tolerance +/- 10%



PORTAL LED

BULKHEADS

LED GO!



123..
included

SPECIFICATION

Ingress protection class:	IP54
Impact resistance:	IK08
Total luminous flux*:	max. 310lm (4000K)
Colour temperature (CCT):	3000K, 4000K
Energy efficiency class (EEI):	A
Power supply:	220-240V / 50-60Hz
Mounting:	surface
Body:	plastic
Diffuser:	PC OPAL

Surface mounted, rectangle LED light fixture with ingress protection class IP54 and an integrated energy-saving light source LED GO!. White ABS base; diffuser made of impact resistant PC provides even light distribution and ensures a high impact resistance class (IK08). Fitting available in two power versions: 2W and 6W; optional equipment: radio motion sensor (RCR) or a dusk sensor. Colour temperature 3000K/4000K, CRI>80, lifespan of LED 50 000h (L70B50) $t_a=25^{\circ}\text{C}$.

LIGHT BEAM CURVES

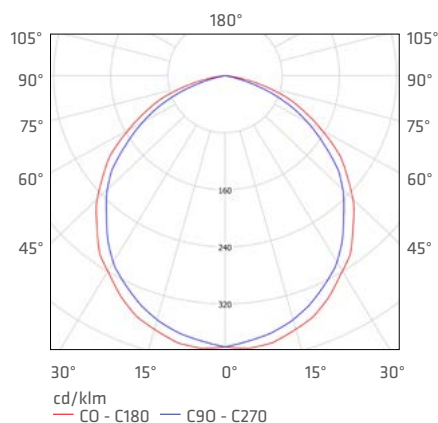

APPLICATION

Surface mounted luminaire for mounting on ceilings and walls; intended for indoor use (rooms with high humidity, passageways, staircases) as well as outdoor use (facade lighting). The version with a radio motion sensor (RCR) is particularly well-suited to be used as a light source for public rooms and buildings (civic buildings, apartment buildings). The 2W version with a dusk sensor is perfect for illuminating markings on building, storage halls, or parking lots (a set of numerals included with the fitting).



PORTAL LED

BULKHEADS

PORTAL LED

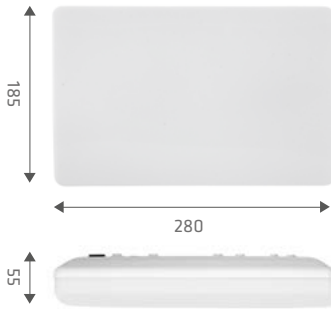
IP54 | IK08 | 



0,50 KG  0,57 KG  RCR

rated power [W]	temperatura barwowa [K]	total luminous flux* [lm]	diffuser	sensor	EEL	index
2	3000	150	OPAL	-	A	199578
2	4000	200	OPAL	-	A	199509
2	3000	150	OPAL	DUSK	A	199653
2	4000	200	OPAL	DUSK	A	199646
6	3000	280	OPAL	-	A	199523
6	4000	310	OPAL	-	A	199516
6	3000	280	OPAL	RCR	A	199547
6	4000	310	OPAL	RCR	A	199530
6	3000	280	OPAL	DUSK	A	199639
6	4000	310	OPAL	DUSK	A	199622

* Initial, tolerance +/- 10%



POINT LED

BULKHEADS

LED GO!



SPECIFICATION

Ingress protection class:	IP44
Total luminous flux*:	max. 930lm (4000K)
Colour temperature (CCT):	3000K, 4000K
Energy efficiency class (EEI):	A
Power supply:	220-240V / 50-60Hz
Mounting:	surface
Body:	PP
Diffuser:	GLASS OPAL, PRM

Surface mounted, round LED light fixture with ingress protection class IP44 and an integrated energy-saving light source LED GO!. White base made of polypropylene; opal or prismatic glass diffuser. Available with a radio motion sensor (RCR). Colour temperature 3000K/4000K, CRI>80, lifespan of LED 50 000h (L70B50) $t_a=25^{\circ}\text{C}$.

LIGHT BEAM CURVES

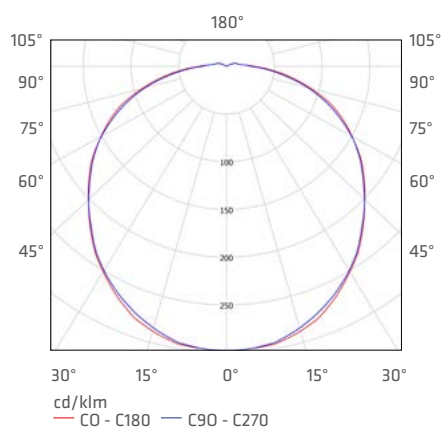

APPLICATION

Surface mounted luminaire for mounting on ceilings and walls; intended both for indoor (maintenance rooms, passageways) and outdoor use (facade lighting). The version with a radio motion sensor (RCR) is particularly well-suited to be used as a light source for public rooms and buildings (civic buildings, apartment buildings).

POINT LED

BULKHEADS

POINT LED 6W

IP44 | 



1,00  1,07  RCR

rated power [W]	colour temperature [K]	total luminous flux* [lm]	diffuser	sensor	EEL	index
6	3000	560	OPAL	-	A	225420
6	4000	600	OPAL	-	A	225437
6	3000	640	PRM	-	A	225444
6	4000	690	PRM	-	A	225451
6	3000	560	OPAL	RCR	A	225482
6	4000	600	OPAL	RCR	A	225499
6	3000	640	PRM	RCR	A	225468
6	4000	690	PRM	RCR	A	225475

POINT LED 8W

IP44 | 



1,00  1,07  RCR

rated power [W]	colour temperature [K]	total luminous flux* [lm]	diffuser	sensor	EEL	index
8	3000	770	OPAL	-	A	225116
8	4000	810	OPAL	-	A	225123
8	3000	850	PRM	-	A	225130
8	4000	930	PRM	-	A	225147
8	3000	770	OPAL	RCR	A	225246
8	4000	810	OPAL	RCR	A	225253
8	3000	850	PRM	RCR	A	225222
8	4000	930	PRM	RCR	A	225239

* Initial, tolerance +/- 10%



OVAL PRO LED

BULKHEADS

LED GO!



SPECIFICATION

Ingress protection class:	IP44
Impact resistance:	IK10
Total luminous flux*:	max. 360lm (4000K)
Colour temperature (CCT):	3000K, 4000K
Energy efficiency class (EEI):	A+
Power supply:	220-240V / 50-60Hz
Mounting:	surface
Body:	PP
Diffuser:	Makrolon® LED OPAL

Surface-mounted, modern technical bulkhead suitable for installing on walls and ceilings. Its design allows surface mounted wiring as well as through wiring. Equipped with an opal diffuser made of Makrolon® LED (Bayer) providing excellent dispersion and allowing up to 93% light transmission. The unique, patented design, includes direct installation of LED panels on the diffuser. The diffuser is connected to the base on a movable hinge, which provides easy access to the terminal block and mounting points of the lamp. The fitting is highly impact-resistant IK10 and has ingress protection class IP44.

LIGHT BEAM CURVES

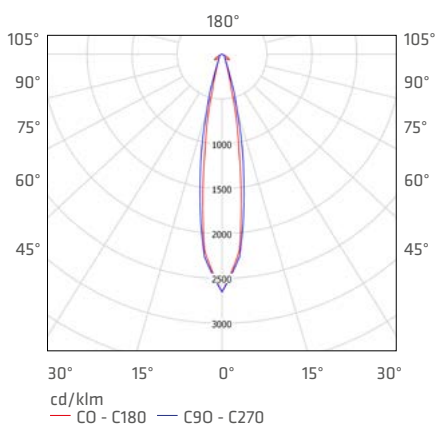

APPLICATION

Dedicated for both indoor (rooms with high humidity, passageways, staircases and basements) and outdoor use (industrial facade lighting, car parks). Easy access to mounting points. Through-wiring system. Gaskets. Easy access to terminal lock. Easy access to the mounting holes. Installation of LED GO! panels directly on the diffuser.

OVAL PRO LED

BULKHEADS

OVAL LED PRO

IP44 | IK10 | 



0,11  KG

rated power [W]	colour temperature [K]	total luminous flux* [lm]	diffuser	EEL	index
4	3000	320	MAKROLON LED OPAL	A+	233432
4	4000	360	MAKROLON LED OPAL	A+	233425

* Initial, tolerance +/- 10%

TECHNICAL DETAILS



Electrical block and assembly points easy to reach



Through-wiring system



Gaskets



Easy access to the mounting bracket.



Easy access to mounting holes.



Mounting LED panels directly on the diffuser.

OVAL LUX LED

BULKHEADS

LED GO!



SPECIFICATION

Ingress protection class:	IP44
Total luminous flux*:	max. 370lm (4000K)
Colour temperature (CCT):	3000K, 4000K
Energy efficiency class (EEI):	A++, A+
Power supply:	220-240V / 50-60Hz
Mounting:	surface
Body:	PP
Diffuser:	glass: OPAL, MAT

Surface mounted, oval LED luminaire with an integrated energy-saving LED GO! panel provides high luminous flux and the highest energy-saving class A++ intended for lighting appliances. Body made of polypropylene and a diffuser made of glass – available in 2 options: opal and frosted. Specification: color temperature 3000K, 4000K; CRI>80; lifespan of LED panels 30 000 hours (L70).

LIGHT BEAM CURVES

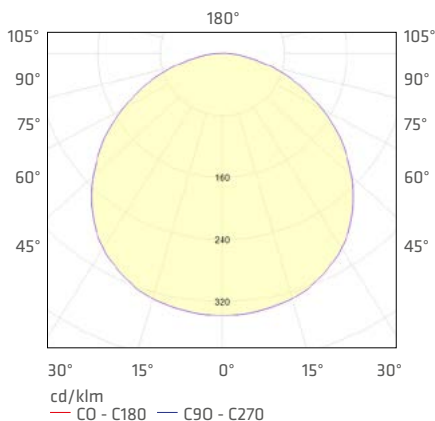

APPLICATION

Surface mounted fitting with an ingress protection class of IP44 dedicated for both outdoor (shelters, car parks) and indoor use (for industrial use and in rooms with high humidity, passageways, staircases, industrial pits, basements).

OVAL LUX LED

BULKHEADS

OVAL LUX LED

IP44 

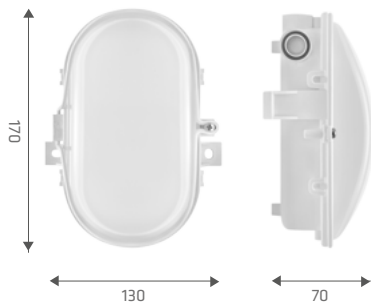

0,33  KG

rated power [W]	colour temperature [K]	total luminous flux* [lm]	diffuser	EEL	index
2,5	3000	210	OPAL	A+	233470
2,5	4000	230	OPAL	A+	233456
2,5	3000	340	MAT	A++	233487
2,5	4000	370	MAT	A++	233463

* Initial, tolerance +/- 10%



OVAL LED

BULKHEADS

LED GO!



SPECIFICATION

Ingress protection class:	IP44 / IP40
Total luminous flux*:	max. 340lm (4000K)
Colour temperature (CCT):	3000K, 4000K
Energy efficiency class (EEI):	A+
Power supply:	220-240V / 50-60Hz
Mounting:	surface
Body:	PP
Diffuser:	GLASS PRM

Surface mounted, oval channel-type LED fitting with, ingress protection class IP44 and an integrated energy-saving light source LED GO!. Polypropylene base; prismatic glass diffuser. Fitting is available in two power versions and six base colours. Also available are numerous special-purpose versions: a 24V fitting or fittings that can be used as marker lights (Oval LED RED equipped with red-coloured diodes and Oval LED BLUE equipped with blue-coloured diodes). Colour temperature 3000K/4000K, CRI>80, lifespan of LED 50 000h (L70B50) $t_a = 25^\circ\text{C}$.

LIGHT BEAM CURVES

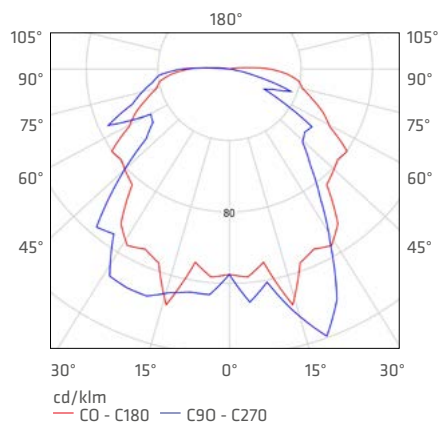

APPLICATION

Surface mounted luminaire for mounting on ceilings and walls; intended for indoor use (rooms with high humidity, passageways and staircases, sewers and basements) as well as outdoor use (industrial facade lighting, parking lots).

OVAL LED

BULKHEADS

OVAL LED WHITE

IP44 | IP40 | 

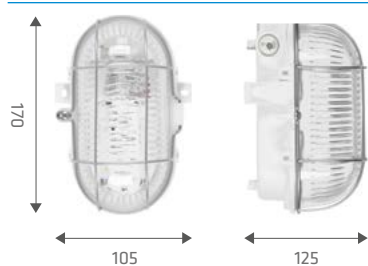

0,50  KG

rated power [W]	colour temperature [K]	total luminous flux* [lm]	diffuser	EEl	index
4,5	3000	340	PRM	A+	233203
3	4000	210	PRM	A+	233012

OVAL LED SILVER

IP44 | IP40 | 

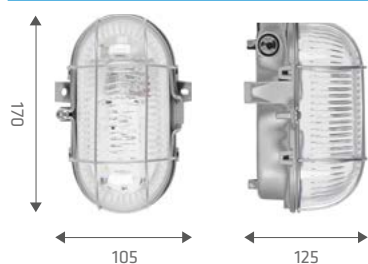

0,50  KG

rated power [W]	colour temperature [K]	total luminous flux* [lm]	diffuser	EEl	index
4,5	3000	340	PRM	A+	233265
3	4000	210	PRM	A+	233074

OVAL LED MAT SILVER

IP44 | IP40 | 

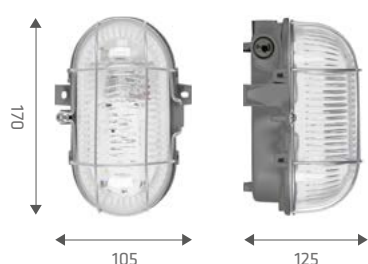

0,50  KG

rated power [W]	colour temperature [K]	total luminous flux* [lm]	diffuser	EEl	index
4,5	3000	340	PRM	A+	233258
3	4000	210	PRM	A+	233067

OVAL LED BLUE

IP44 | IP40 | 

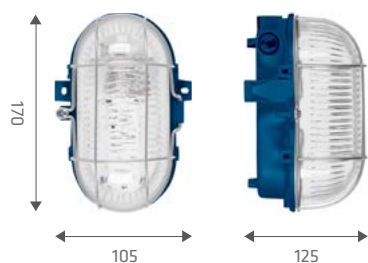

0,50  KG

rated power [W]	colour temperature [K]	total luminous flux* [lm]	diffuser	EEl	index
4,5	3000	340	PRM	A+	233241
3	4000	210	PRM	A+	233050

OVAL LED RED

IP44 | IP40 | 

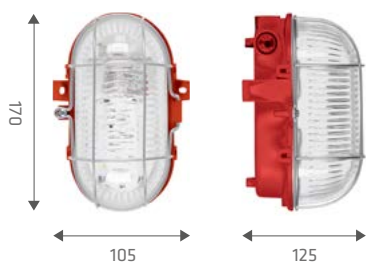

0,50  KG

rated power [W]	colour temperature [K]	total luminous flux* [lm]	diffuser	EEl	index
4,5	3000	340	PRM	A+	233234
3	4000	210	PRM	A+	233043

OVAL LED

BULKHEADS

OVAL LED BROWN

IP44 | IP40 | 



0,50 

rated power [W]	colour temperature [K]	total luminous flux* [lm]	diffuser	EEl	index
4,5	3000	340	PRM	A+	233210
3	4000	210	PRM	A+	233029

OVAL LED BLACK

IP44 | IP40 | 

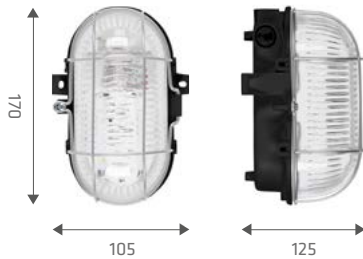

0,50 

rated power [W]	colour temperature [K]	total luminous flux* [lm]	diffuser	EEl	index
4,5	3000	340	PRM	A+	233227
3	4000	210	PRM	A+	233036

FITTINGS WITH COLORED LED DIODES:

OVAL LED RED

IP44 | IP40 | 

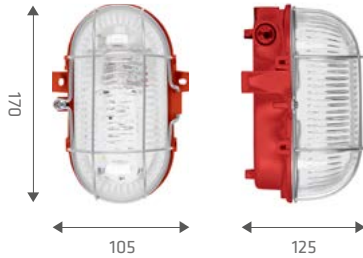

0,50 

rated power [W]	LED diode colour	diffuser	index
3	red	PRM	233166

OVAL LED BLUE

IP44 | IP40 | 

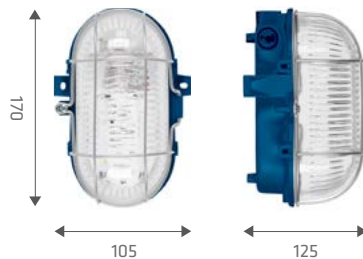

0,50 

rated power [W]	LED diode colour	diffuser	index
3	blue	PRM	233180

OVAL LED MAT SILVER

IP44 | IP40 | 

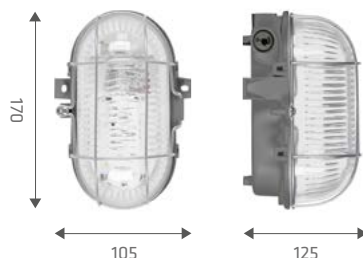

0,50 

rated power [W]	LED diode colour	diffuser	index
3	red	PRM	233159
3	blue	PRM	233173

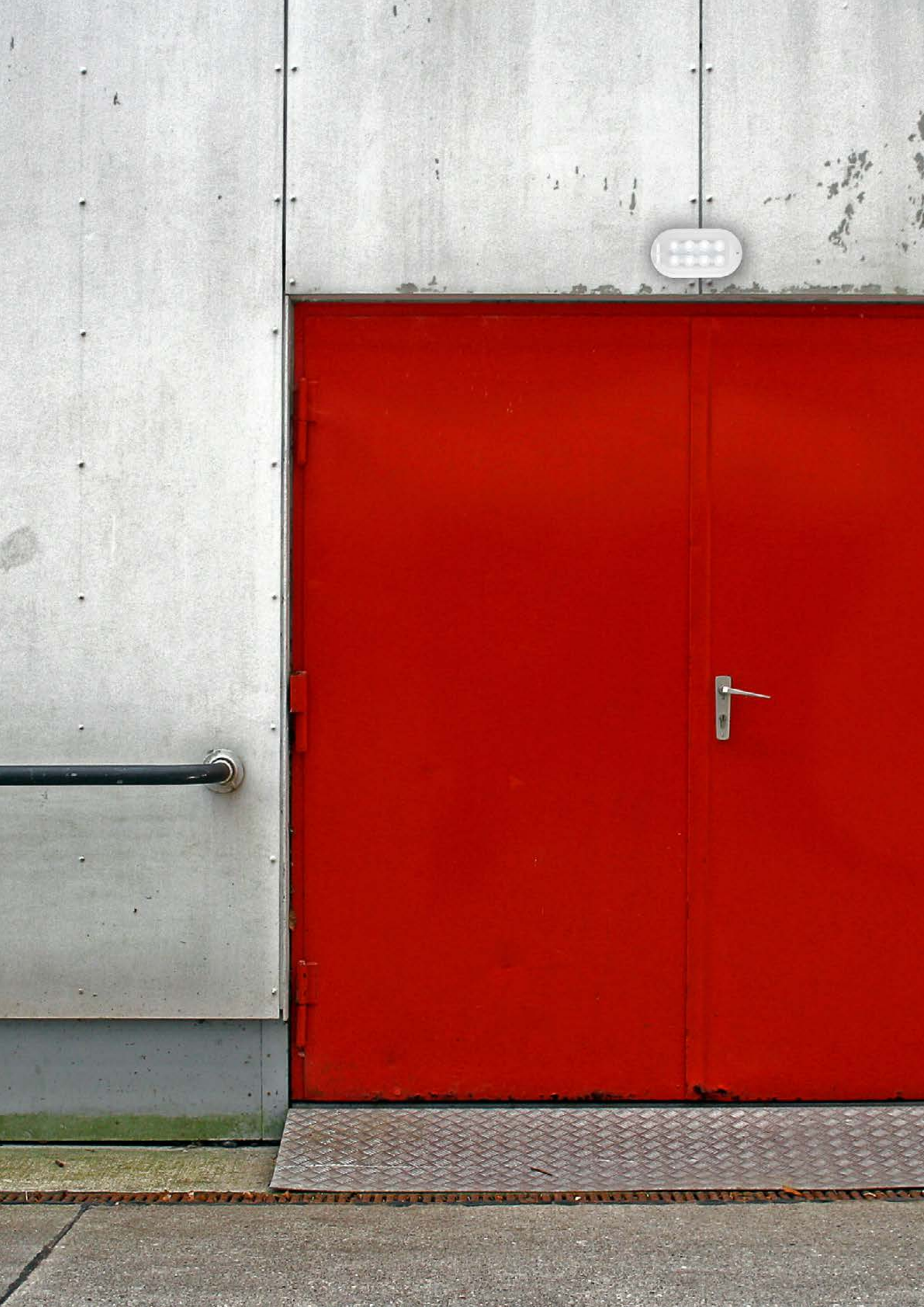





STREET LIGHTING



LED SOURCE

- + colour temperature 5500K
- + RA = 75-80
- + durability over 3 times higher than sodium
- + instant ignition/starter
- + possible work at low temperature
- + much lower energy consumption

COMFORT
SAVINGS
SAFETY



SODIUM SOURCE

temperature 2000K
RA ≤ 25



CORONA LED

CORONA LED is a multipurpose streetlight fitting with parameters IP66, IK08. Due to special optical systems it is available in four light-distribution's options. Total luminous flux - 8550 lm.



VERSATILITY

Due to special optical systems CORONA LED enables effective, economical and efficient lighting of such places as roads and streets, car parks and yards, zebra crossings, crossroads, roundabouts or exits.

UTILITY

Compact dimensions, weight and side surface of the fitting (<math><0,04 \text{ m}^2</math>) are not a heavy load for a lighting pole and they enable installation in wind load conditions typical for the area of Europe.

FUNCTIONALITY

The fitting has the CE mark, typical parameters of power supply, it is made according to the I class of protection and it ensures comfortable access to a connection box.

TECHNICAL DETAILS

APPLICATION OF CORONA LED FITTING



CORONA LED

This type of fitting is one-panel fitting with the power of 16W and 36W, it has asymmetric light distribution focused on the most efficient lighting of bicycle paths and pedestrian precincts. Because of lack of sodium sources with the power below 50W, CORONA LED enables replacing 50 W sodium fittings and it ensures 68% of savings by mounting directly to a 6 meters high pole.

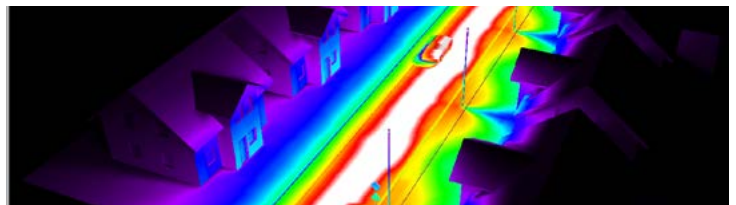

CORONA LED S

This type of fitting has asymmetric light distribution focused on the most efficient lighting of roads and streets. In normal conditions of street geometry, by mounting directly to a pole, it enables lighting of street and pavement at the same time without using a side entry, which reduces significantly the investment costs.

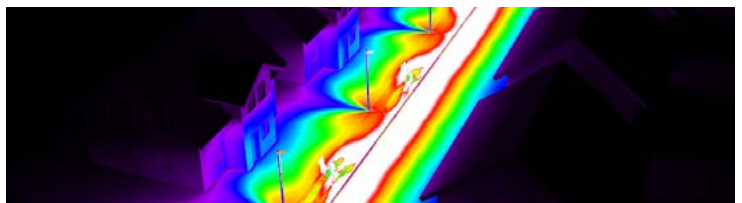



CORONA LED P

This type of fitting has asymmetric light distribution focused on the most efficient lighting of car parks and yards. CORONA LED P 80W mounted on a 10 metres high pole, without a side entry, ensures the light intensity (brightness) of 5 lux for a car park with the parameters 34,5m X 15m (normal parameters for a car park with 30 parking spaces and a manoeuvring place).

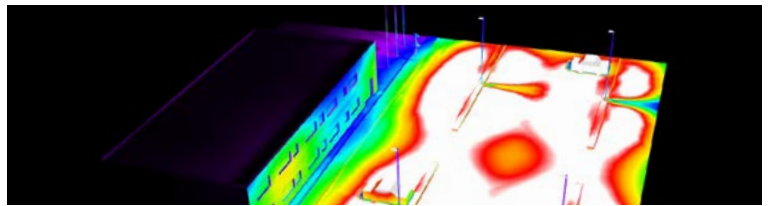

CORONA LED W

This type of fitting has asymmetric light distribution focused on the most efficient lighting of zebra crossings for pedestrians. Setting two fittings on the opposite sides of the street allows to light pedestrians on a zebra crossing and on a pavement in positive contrast and reduces a glare effect for drivers.

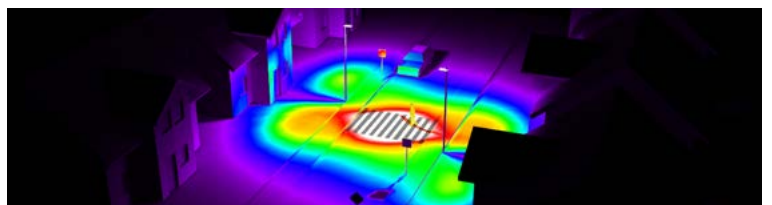

CORONA LED C

This type of fitting has asymmetric light distribution focused on the most efficient lighting of the areas particularly endangered with accidents, such as crossroads, roundabouts, exits. Setting the fitting as close to the crossroads as possible enables to light the crossing streets.

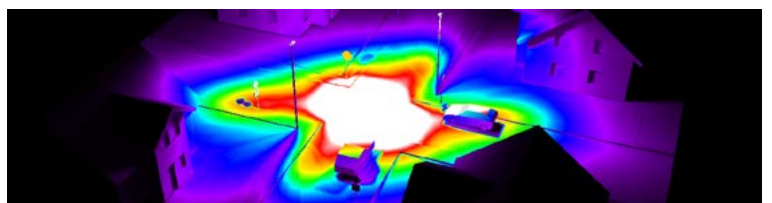

CORONA LED

STREET LIGHTING

LED GO!



SPECIFICATION

Ingress protection class:	IP66
Impact resistance:	IK08
Total luminous flux*:	max. 8550lm (5700K)
Colour temperature (CCT):	4200K, 5700K
CRI (Ra):	>75
Energy efficiency class (EEI):	A+, A
Power supply:	220-240V / 50-60Hz
Mounting:	side mounting the boom peak assembly, directly on the pole
Diffuser:	PC OPAL
Body:	powder coated aluminium

Street lighting fitting with an integrated energy-saving light source LED GO! with white light colour temperature (5700K), high ingress protection IP66 and raised impact resistance IK08. High colour rendering index (Ra 80) allows accuracy of colour mapping and ability to recognize details in scotopic vision. Fitting and bracket made of die-cast aluminium, grey powder coated. Mounting plate made of steel. Corona fitting is equipped with lenticular arrays made of polycarbonate due to obtain a suitable light distribution for special use. The fitting enables post top mounting directly to the pole or side entry mounting. Integrated step adjustment holder allows to horizontal position in the range of 0°-15° in 5° leap. Lifespan of LED 50 000h (L80F10) $t_a = 25\text{ }^\circ\text{C}$.

LIGHT BEAM CURVES

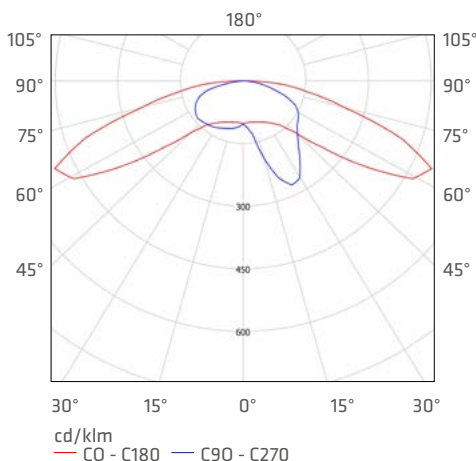

APPLICATION

Corona has many possibilities of application which is obtained due to asymmetric LED light distribution that gives desirable assembly. Fitting is available in 4 versions of power (18W/36W/52W/80W).

CORONA LED

STREET LIGHTING

CORONA LED

IP66 | IK08 | 

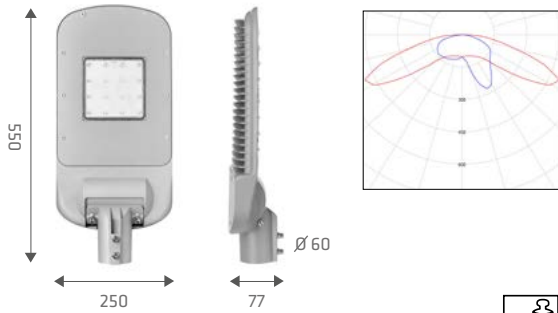

5,20  KG

rated power [W]	colour temperature [K]	total luminous flux* [lm]	protection class	EEl	index
18	5700	2300	I	A+	503009

CORONA LED C

IP66 | IK08 |  

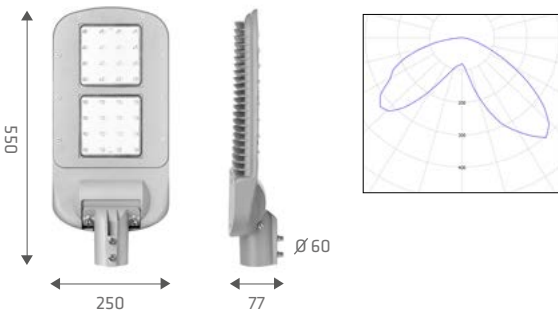

5,20  KG

rated power [W]	colour temperature [K]	total luminous flux* [lm]	protection class	EEl	index
36	4200	4500	I	A+	549007
36	4200	4500	II	A+	549229
36	5700	5000	I	A+	503016
36	5700	5000	II	A+	549182
52	4200	6200	I	A+	549014
52	4200	6200	II	A+	549106
52	5700	6900	I	A+	503139
52	5700	6900	II	A+	503658
80	4200	7700	I	A+	549021
80	4200	7700	II	A+	549113
80	5700	8550	I	A+	503030
80	5700	8550	II	A+	503184

CORONA LED P

IP66 | IK08 |  

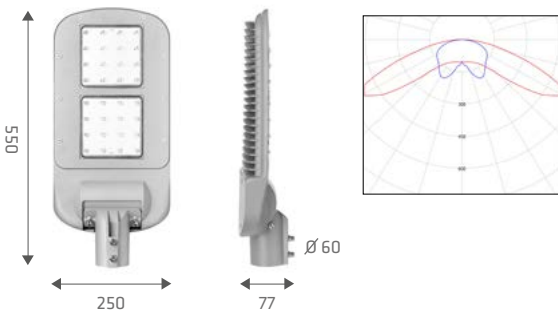

5,20  KG

rated power [W]	colour temperature [K]	total luminous flux* [lm]	protection class	EEl	index
36	4200	4500	I	A+	549038
36	4200	4500	II	A+	549236
36	5700	5000	I	A+	503047
36	5700	5000	II	A+	549199
52	4200	6200	I	A+	549045
52	4200	6200	II	A+	549120
52	5700	6900	I	A+	503115
52	5700	6900	II	A+	503665
80	4200	7700	I	A+	549052
80	4200	7700	II	A+	549137
80	5700	8550	I	A+	503078
80	5700	8550	II	A+	503153

* Initial, tolerance +/- 10%

CORONA LED

STREET LIGHTING

CORONA LED S

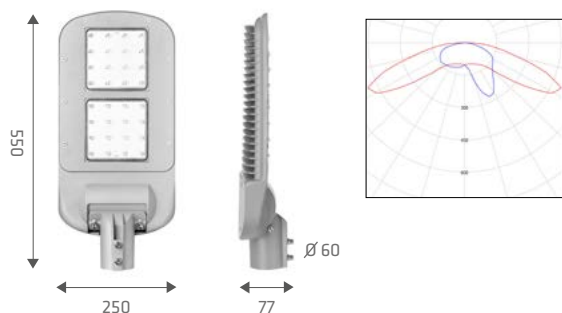

IP66 | IK08 |  



5,20  KG

rated power [W]	colour temperature [K]	total luminous flux* [lm]	protection class	EEl	index
36	4200	4500	I	A+	452680
36	4200	4500	II	A+	549243
36	5700	5000	I	A+	503054
36	5700	5000	II	A+	549205
52	4200	6200	I	A+	503146
52	4200	6200	II	A+	549144
52	5700	6900	I	A+	503108
52	5700	6900	II	A+	503672
80	4200	7700	I	A+	549069
80	4200	7700	II	A+	549151
80	5700	8550	I	A+	503085
80	5700	8550	II	A+	503160

CORONA LED W

IP66 | IK08 |  

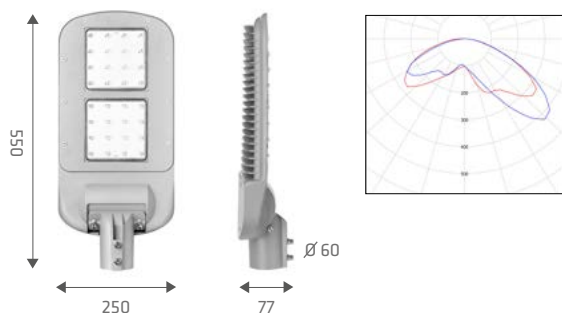

5,20  KG

rated power [W]	colour temperature [K]	total luminous flux* [lm]	protection class	EEl	index
36	4200	4500	I	A+	549076
36	4200	4500	II	A+	549250
36	5700	5000	I	A+	503061
36	5700	5000	II	A+	549212
52	4200	6200	I	A+	549083
52	4200	6200	II	A+	549168
52	5700	6900	I	A+	503122
52	5700	6900	II	A+	503689
80	4200	7700	I	A+	549090
80	4200	7700	II	A+	549175
80	5700	8550	I	A+	503092
80	5700	8550	II	A+	503177

* Initial, tolerance +/- 10%

Available options: **DALI**, **RST Wieland connector**.

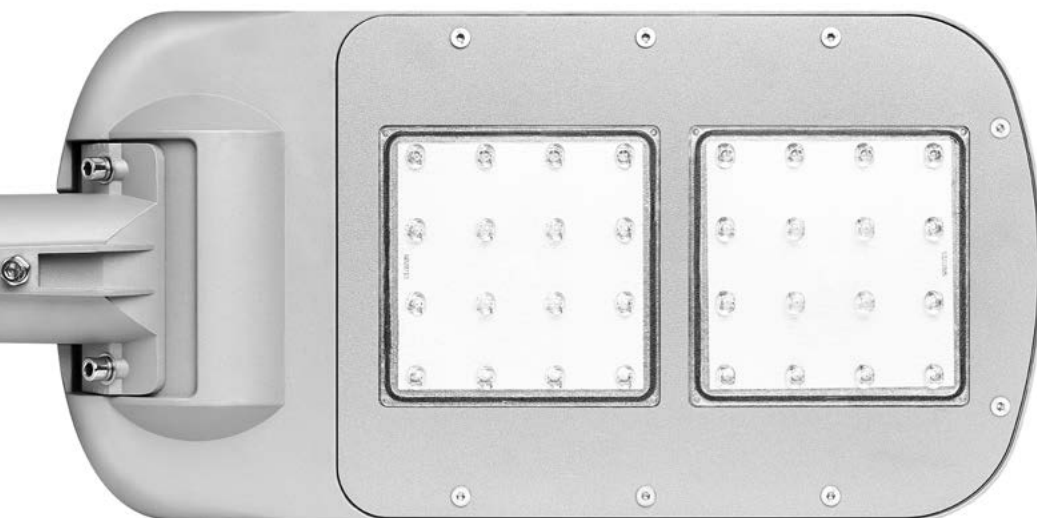



CORONA ROAD LED

STREET LIGHTING

LED GO!

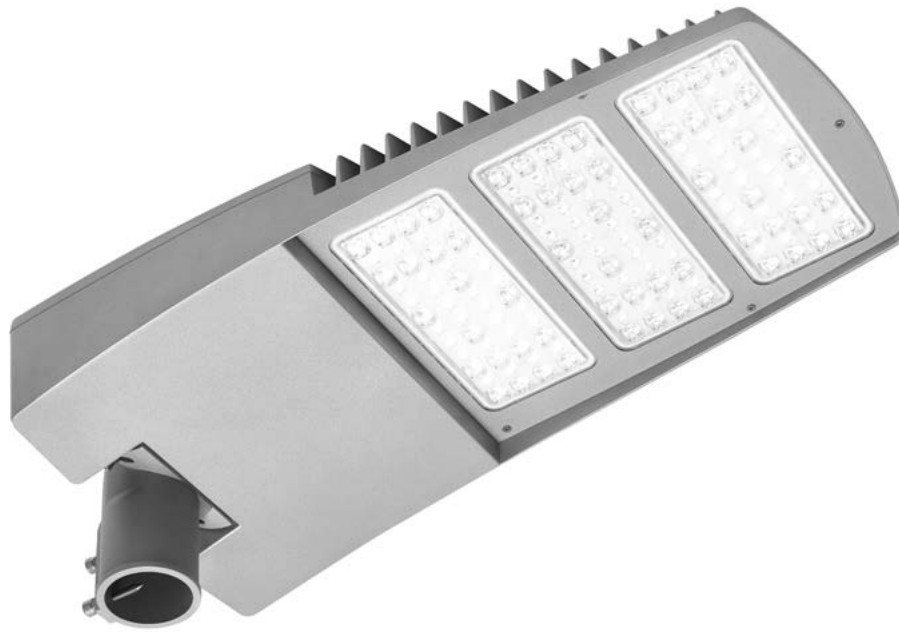

SPECIFICATION

Ingress protection class:	IP66
Impact resistance:	IK08
Total luminous flux*:	max. 22 650lm (5700K)
Colour temperature (CCT):	5700K
CRI (Ra):	>75
Energy efficiency class (EEI):	A+
Power supply:	220-240V / 50-60Hz
Mounting:	side mounting the boom peak assembly, directly on the pole
Diffuser:	PMMA lens
Body:	powder coated aluminium

This road LED fitting in daylight colour, with integrated energy-saving LED panel and high luminous flux. White light (5700K) and a high rate of colour rendering index $Ra > 70$ ensures accurate colour rendering and the ability to recognize more detail in night vision (scotopic). The body and the grip made of die-cast aluminium. The entire unit was powder-coated grey. The fitting uses directional lens matrices made of PMMA, thus meeting the PN-EN 13201:2007 standard requirements. IP66 ingress protection class and IK08 impact-rating features make this fitting extremely tight and shock-resistant (vandal-resistant). Integrated, step-regulated grip allows to set the fitting vertically in the range of 0° - 15° by 5° . Available options with: power reducer, DALI, tempered glass and an additional overvoltage protection up to 10kV. Specification: lifespan of LED panels: 50 000 hours (L80F10) $t_a = 25^{\circ}\text{C}$.

LIGHT BEAM CURVES

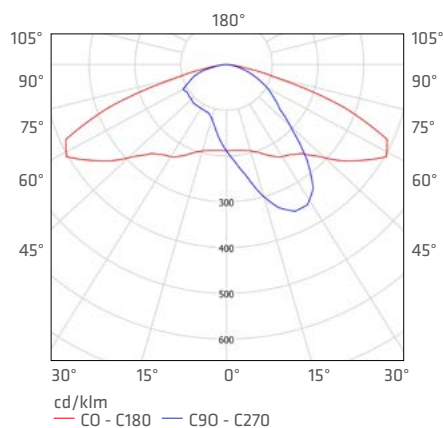



APPLICATION

This road fitting is designed to be used in open areas for lighting: highways, expressways, streets, local roads and crossroads.

CORONA ROAD LED

STREET LIGHTING

CORONA ROAD LED

IP66 | IK08 |  | 

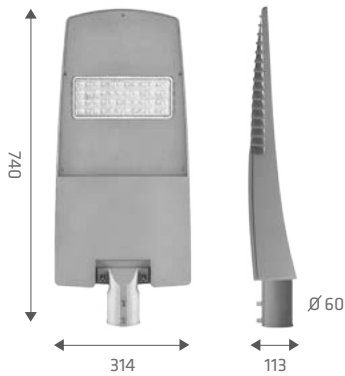

7,70  KG

rated power [W]	colour temperature [K]	total luminous flux* [lm]	protection class	EEl	index
48	4000	6600	I	A+	563584
48	4000	6600	II	A+	563317
48	5700	7050	I	A+	504471
48	5700	7050	II	A+	504594

CORONA ROAD LED

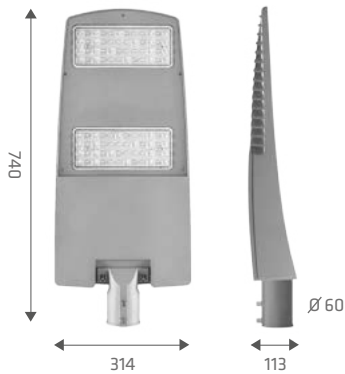

IP66 | IK08 |  | 



7,85  KG

rated power [W]	colour temperature [K]	total luminous flux* [lm]	protection class	EEl	index
96	4000	13400	I	A+	563669
96	4000	13400	II	A+	564208
96	5700	14300	I	A+	503535
96	5700	14300	II	A+	503610

CORONA ROAD LED P

IP66 | IK08 |  | 

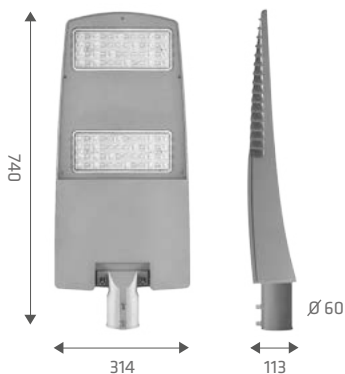

7,85  KG

rated power [W]	colour temperature [K]	total luminous flux* [lm]	protection class	EEl	index
96	4000	13400	I	A+	564444
96	4000	13400	II	A+	564680
96	5700	14300	I	A+	504730
96	5700	14300	II	A+	504853

* Initial, tolerance +/- 10%

CORONA ROAD LED P - version for lighting car parks and squares.

CORONA ROAD LED

STREET LIGHTING

CORONA ROAD LED

IP66 | IK08 |  

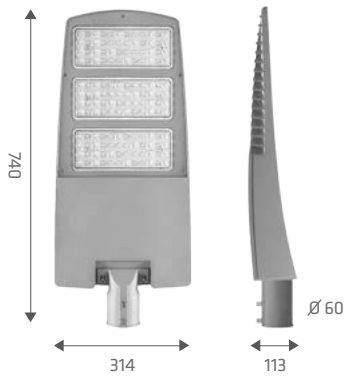

8,60  KG

rated power [W]	colour temperature [K]	total luminous flux* [lm]	protection class	EEL	index
144	4000	21250	I	A+	563003
144	4000	21250	II	A+	563942
144	5700	22650	I	A+	503542
144	5700	22650	II	A+	503627

* Initial, tolerance +/- 10%

Available options: **With a power reducer, DALI, tempered glass and an additional overvoltage protection up to 10kV.**

ACCESSORIES

index	article name
UL00141	Holder Ø 76mm





CORONA LITE LED

STREET LIGHTING

LED GO!



SPECIFICATION

Ingress protection class:	IP66
Impact resistance:	IK08
Total luminous flux*:	max. 8250lm (5500K)
Colour temperature (CCT):	4000K, 5700K
Energy efficiency class (EEI):	A++, A+
Power supply:	220-240V / 50-60Hz
Mounting:	side mounting the boom peak assembly, directly on the pole
Optics	PMMA lens
Body:	polypropylene (PP) + glass fiber reinforced material

Streetlight LED fitting with high luminous flux and an integrated energy-saving LED panel. White light (4000K or 5700K) and a high rate of color rendering index $R_a > 70$ ensure accurate color rendering and the ability to recognize more details in night vision. The body made of polyamide (PA) with fibreglass (GF) and the grip made of aluminium. Thanks to the directional lens (made of PMMA), the light distribution meets the requirements of PN-EN 13201 lighting class. IP66 ingress protection class and IK08 impact-rating features make this fitting extremely tight and shock-resistant (vandal-resistant). Integrated, step-regulated grip allows to set the fitting horizontally in the range of $0^\circ - 15^\circ$ by 5° . Lifespan of LED panels: 50 000 hours. Specification: color temperature 4000K, 5700K; lifespan of LED panels: 50 000 hours (L70).

LIGHT BEAM CURVES

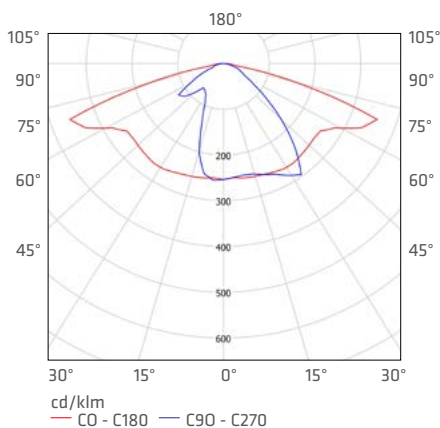

APPLICATION

Streetlight fitting used in open spaces to lighten: streets, local roads, bicycle paths, alleys, pavements, car parks and squares. Installation and Mounting: lateral side entry, post-top mounting. (mounting grip integrated with the fitting).

CORONA LITE LED

STREET LIGHTING

CORONA LITE LED 35W IP66 IK08

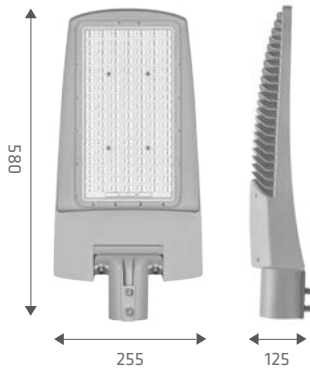

2,30 KG

rated power [W]	colour temperature [K]	total luminous flux* [lm]	EEl	protection class	indeks
35	4000	4750	A++	I	504723
35	4000	4750	A++	II	504044
35	5700	4850	A++	I	504006
35	5700	4850	A++	II	504051

CORONA LITE LED 50W IP66 IK08

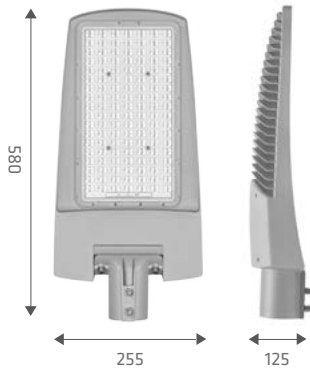

2,30 KG

rated power [W]	colour temperature [K]	total luminous flux* [lm]	EEl	protection class	indeks
50	4000	6550	A+	I	504075
50	4000	6550	A+	II	504716
50	5700	6650	A+	I	504013
50	5700	6650	A+	II	504082

CORONA LITE LED 65W IP66 IK08

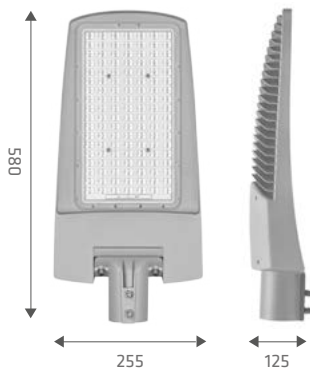

2,30 KG

rated power [W]	colour temperature [K]	total luminous flux* [lm]	EEl	protection class	indeks
65	4000	8100	A+	I	504099
65	4000	8100	A+	II	504020
65	5700	8250	A+	I	504037
65	5700	8250	A+	II	504976

* Initial, tolerance +/- 10%

ACCESSORIES

index	article name
UL00141	Holder ø76mm





EMERGENCY LIGHTING



DOT LED

DOT LED fittings belong to independent line of products ensuring lighting of evacuation ways and exits when there is no mains voltage.



APPLICATION

Independent emergency fitting in two options: surface and recessed. Two kinds of light distribution - symmetrical (wide for open spaces) and narrow-elliptical for long corridors.

IMPACT RESISTANCE

Aluminium, powder-coated white DOT LED bodies show high impact resistance (IK10) and the diffuser is made of PMMA (IK08).

IP20/IP44

DOT LED fittings are made according to the I class of protection and two versions of ingress protection class: IP20 (basic rate) or IP44 (optional).

DOT N/P LED

EMERGENCY LIGHTING

LED



SPECIFICATION

Ingress protection class:	IP44, IP20
Impact resistance:	IK10 (body) IK08 (lenses)
Total luminous flux:	200lm / 5500K
Colour temperature (CCT):	5500K
Power supply:	230V/50Hz
Battery:	NiMh 3,6V - 1h/2h/3h
Mounting:	surface / wall (N) (C/N) recessed (P) (C/P)
Diffuser:	lenses
Body:	aluminium

Surface mounted or recessed mounted autonomous emergency fitting including an integrated, energy-saving LED GO! light source with a power of 3W. Body made of aluminum, powder-coated white. Optical system with symmetric distribution (all-round) or asymmetric distribution (narrow beam, passageways) made of prismatic PC. Several battery versions available, with a life of 1h, 2h or 3h in non maintained operation. Each version uses Ni-Mh HT batteries with a voltage of 3.6V, a 24-hour charging period and either manual or automatic testing (AT) function. DOT LED fittings are made according to requirements for security level I and are available in two ingress protection class versions: IP20 (basic standard) or IP44 (option).

LIGHT BEAM CURVES

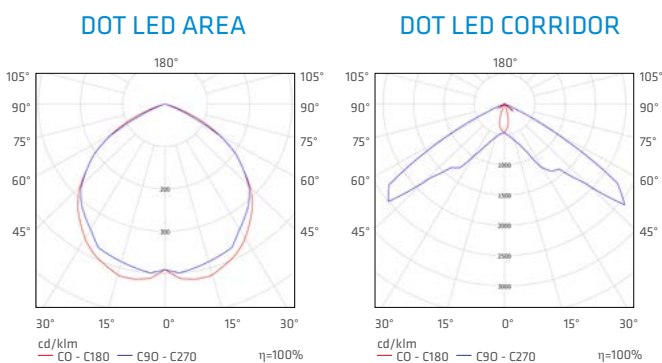

APPLICATION

Autonomous emergency fitting, the main application for which is to illuminate evacuation routes and emergency exits in the event of voltage drop in the power grid, i.e. in non-maintained mode. Recommended specifically for areas, where it is necessary to install emergency lighting as part of modernization of existing systems. Thanks to improved tightness the product has an ingress protection class IP44 and may be used in areas with high humidity or installed outdoors under roofs.

DOT LED AREA - wide, spherical light distribution suitable for open spaces such as offices, halls, shops.

DOT LED CORRIDOR - narrow, elliptical light distribution dedicated for corridors, which enables to install the fittings every 11 m at the height of 3 meters.

DOT N/P LED

EMERGENCY LIGHTING

DOT N LED

IP44 | IP20 | IK08 | IK10 | ⚡

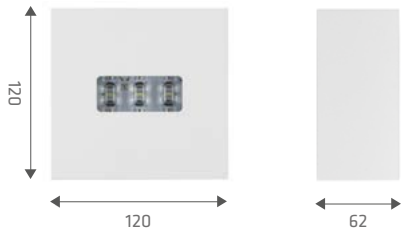

0,80 KG

rated power [W]	colour temperature [K]	total luminous flux* [lm]	IP	emergency mode [h]	autotest	index
3	5500	200	20	1	AT	544958
3	5500	200	20	1	-	544941
3	5500	200	20	2	AT	544972
3	5500	200	20	2	-	544965
3	5500	200	20	3	AT	544996
3	5500	200	20	3	-	544989
3	5500	200	44	1	AT	545139
3	5500	200	44	1	-	545122
3	5500	200	44	2	AT	545153
3	5500	200	44	2	-	545146
3	5500	200	44	3	AT	545177
3	5500	200	44	3	-	545160

DOT P LED

IP44 | IP20 | IK08 | IK10 | ⚡

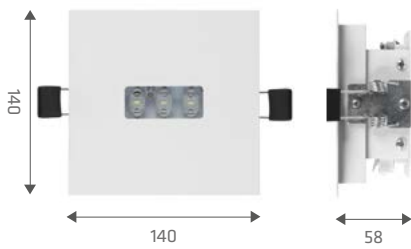

120/120
0,80 KG

rated power [W]	colour temperature [K]	total luminous flux* [lm]	IP	emergency mode [h]	autotest	index
3	5500	200	20	1	AT	545016
3	5500	200	20	1	-	545009
3	5500	200	20	2	AT	545030
3	5500	200	20	2	-	545023
3	5500	200	20	3	AT	545054
3	5500	200	20	3	-	545047
3	5500	200	44	1	AT	545078
3	5500	200	44	1	-	545061
3	5500	200	44	2	AT	545092
3	5500	200	44	2	-	545085
3	5500	200	44	3	AT	545115
3	5500	200	44	3	-	545108

DOT C/N LED

IP44 | IP20 | IK08 | IK10 | ⚡



0,80 KG

rated power [W]	colour temperature [K]	total luminous flux* [lm]	IP	emergency mode [h]	autotest	index
3	5500	200	20	1	AT	544729
3	5500	200	20	1	-	544750
3	5500	200	20	2	AT	544736
3	5500	200	20	2	-	544767
3	5500	200	20	3	AT	544743
3	5500	200	20	3	-	544705
3	5500	200	44	1	AT	544835
3	5500	200	44	1	-	544828
3	5500	200	44	2	AT	544859
3	5500	200	44	2	-	544842
3	5500	200	44	3	AT	544873
3	5500	200	44	3	-	544866

* Initial, tolerance +/- 10%

- surface/wall (N)
- recessed (P)
- surface/wall with corridor light distribution (C/N)
- recessed with corridor light distribution (C/P)



DOT N/P LED

EMERGENCY LIGHTING

DOT C/P LED

IP44 | IP20 | IK08 | IK10 | 



120/120 
0,80 KG 

rated power [W]	colour temperature [K]	total luminous flux* [lm]	IP	emergency mode [h]	autotest	index
3	5500	200	20	1	AT	544798
3	5500	200	20	1	-	544774
3	5500	200	20	2	AT	544804
3	5500	200	20	2	-	544781
3	5500	200	20	3	AT	544811
3	5500	200	20	3	-	544712
3	5500	200	44	1	AT	544897
3	5500	200	44	1	-	544880
3	5500	200	44	2	AT	544910
3	5500	200	44	2	-	544903
3	5500	200	44	3	AT	544934
3	5500	200	44	3	-	544927

* Initial, tolerance +/- 10%

- surface/wall (N)
- recessed (P)
- surface/wall with corridor light distribution (C/N)
- recessed with corridor light distribution (C/P)





LUMAX S LED

EMERGENCY LIGHTING

LED



SPECIFICATION

Ingress protection class:	IP40	Surface mounted, universal (maintained or non-maintained system) emergency fitting with a low profile including an integrated, energy-saving LED light source with a power of 2W. Body made of plastic, grey; prismatic polycarbonate (PC) diffuser. NiCd battery with manual testing function included; battery life in the event of emergency is 3h. Usable visibility of exit signs - up to 20 meters.
Power supply:	220-240V / 50-60Hz	
Bateria:	NiCd / 3h	
Mounting:	surface	
Body:	PC	
Diffuser:	PC PRM	



APPLICATION

Autonomous emergency fitting, dedicated for illumination of evacuation routes and emergency exits in the event of voltage drop in the power grid, i.e. in emergency mode. Product intended for surface mounting walls. Recommended particularly for areas of technical nature (passageways, staircases, garages, cellars) and for all applications which require the installation of permanent emergency lighting.

LUMAX S LED

EMERGENCY LIGHTING

LUMAX S LED

IP40 

rated power [W]

diffuser

mode (NM/M)

emergency module

index

2

PRM

NM/M universal

3h

323829



0,80  KG

ACCESSORIES



P2 (617812)



P3 (617829)



P4 (617836)



P5 (617843)



P17 (617993)



P6 (617850)



P6 (617850)



P7 (617867)



P7 (617867)



P10 (617898)



P11 (617904)



P12 (617942)



P13 (618000)



POXAR SN-F LED

EMERGENCY LIGHTING

LED



SPECIFICATION

Ingress protection class:	IP40	Surface mounted emergency fitting with a power of 1W, available in maintained and non-maintained versions. The body is made of polycarbonate; PMMA mounting board. NiCd battery included, battery life in the event of emergency is 3h. NiCd battery with manual testing function included, battery life in the event of emergency is 3h. A bracket for wall mounting available on request.
Power supply:	220-240V / 50-60Hz	
Bat	NiCd / 3h	
Mounting:	surface	
Body:	PC	
Diffuser:	PMMA OPAL	



APPLICATION

The main task of the independent emergency light fitting is to indicate the direction of evacuation routes and emergency exits after a power outage, i.e. in Safe Mode. Suitable for wall or ceiling mounting. Especially recommended in for technical rooms (corridors, stairways, garages, basements) where permanent emergency lighting is required.

POXAR SN-F LED

EMERGENCY LIGHTING

POXAR SN-F LED

IP40 

rated
power [W]

mode
(NM/M)

emergency
module

index

1

NM/M

3h

324543

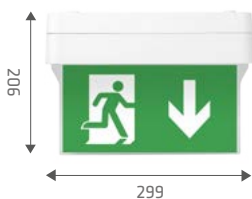

0,85  KG

ACCESSORIES



P2 (618123)



P3 (618130)



618185 - POXAR SN-F WHITE WALL HOLDER







ACCENT LIGHTING

MODO LED

ACCENT LIGHTING

POWER
LED



SPECIFICATION

Ingress protection class:	IP67
Impact resistance:	IK10
Total luminous flux*:	max. 1550lm (5000K)
Colour temperature (CCT):	4000K, 5000K
Energy efficiency class (EEI):	A
Power supply:	220-240V / 50-60Hz
Mounting:	into the ground
Diffuser:	tempered glass
Body:	powder coated aluminium
Ring:	stainless steel

Energy-saving, outdoor 20W uplight fitting, intended for soil-mounting provides economical and long-term operation without replacing light sources. High ingress protection class IP67, makes it resistant to flooding with water. To optimally fulfill its task, it is made of aluminium and tempered glass with extra seal. Available in many light distribution options: 15x45, 10, 30, 50, 75 degrees. Specification: colour temperature of the light source 4000K, 5000K.

LIGHT BEAM CURVES

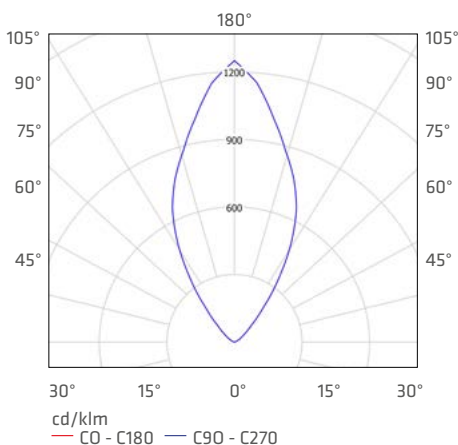

APPLICATION

The fitting is willingly used as facade lighting for various buildings (such as office buildings, commercial buildings, car showrooms, religious buildings) as well as lighting for green areas, parks and other architectural elements.

MODO LED

ACCENT LIGHTING

MODO LED R

IP67 | IK10 | 



4,60  KG

rated power [W]	colour temperature [K]	total luminous flux* [lm]	diffuser	beam angle	EEl	index
20	4000	1400	TRANSPARENT	15°x45°	A	140709
20	5000	1550	TRANSPARENT	15°x45°	A	140723
20	4000	1400	TRANSPARENT	10°	A	140730
20	5000	1550	TRANSPARENT	10°	A	140747
20	4000	1400	TRANSPARENT	30°	A	140754
20	5000	1550	TRANSPARENT	30°	A	140761
20	4000	1400	TRANSPARENT	50°	A	140778
20	5000	1550	TRANSPARENT	50°	A	140785
20	4000	1400	TRANSPARENT	75°	A	140792
20	5000	1550	TRANSPARENT	75°	A	140808

MODO LED KA

IP67 | IK10 | 



5,00  KG

rated power [W]	colour temperature [K]	total luminous flux* [lm]	diffuser	beam angle	EEl	index
20	4000	1400	TRANSPARENT	10°	A	140839
20	5000	1550	TRANSPARENT	10°	A	140846
20	4000	1400	TRANSPARENT	30°	A	140853
20	5000	1550	TRANSPARENT	30°	A	140860
20	4000	1400	TRANSPARENT	50°	A	140877
20	5000	1550	TRANSPARENT	50°	A	140884
20	4000	1400	TRANSPARENT	75°	A	140891
20	5000	1550	TRANSPARENT	75°	A	140907

* Initial, tolerance +/- 10%

TECHNICAL DETAILS

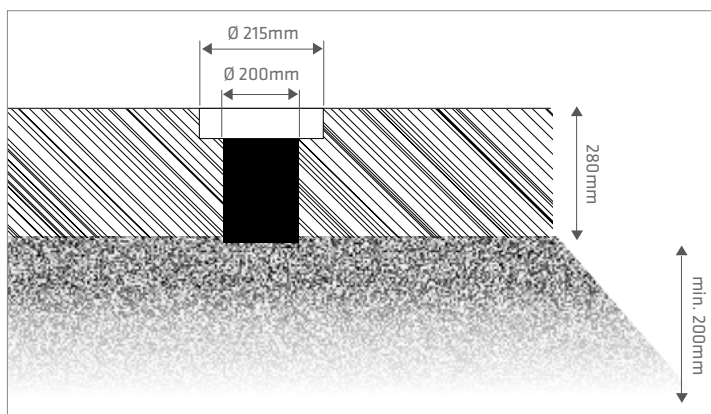

Mounting parameters. Note - when soil-mounting, strictly follow the instructions of assembly. Do not install in places of pedestrian traffic.

MODO MINI LED

ACCENT LIGHTING

POWER
LED



SPECIFICATION

Ingress protection class:	IP67
Impact resistance:	IK10
Total luminous flux*:	max. 250lm (5000K)
Colour temperature (CCT):	3000K, 4000K, 5000K
Energy efficiency class (EEI):	A
Power supply:	220-240V / 50-60Hz
Mounting:	into the ground
Diffuser:	tempered glass
Body:	powder coated aluminium
Ring:	stainless steel

Energy-saving, outdoor 3W uplight fitting, intended for soil-mounting provides economical and long-term operation without replacing light sources. High ingress protection class IP67, makes it resistant to flooding with water. To optimally fulfill its task, it is made of aluminium and tempered glass with extra seal. Available in two light distribution options: 15° and 30°. Specification: colour temperature of the light source 3000K, 4000K, 5000K; light colour: white, red, blue, green.

LIGHT BEAM CURVES

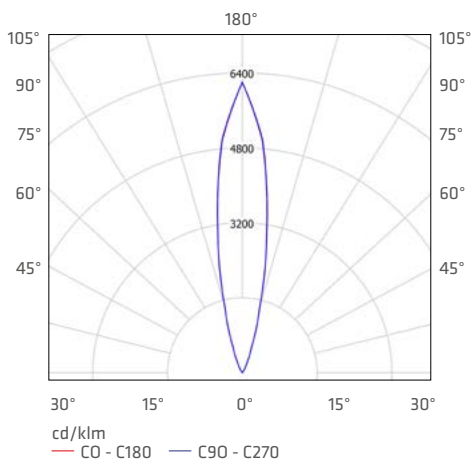

APPLICATION

The fitting is willingly used as facade lighting for various buildings (such as office buildings, commercial buildings, car showrooms, religious buildings) as well as lighting for green areas, parks and other architectural elements.

MODO MINI LED

ACCENT LIGHTING

MODO MINI LED O

IP67 | IK10 | 



0,75  KG

rated power [W]	colour temperature [K]	total luminous flux* [lm]	diffuser	beam angle	EEL	index
3	3000	200	TRANSPARENT	15°	A	140327
3	4000	220	TRANSPARENT	15°	A	140280
3	5000	250	TRANSPARENT	15°	A	140334
3	3000	200	TRANSPARENT	30°	A	140372
3	4000	220	TRANSPARENT	30°	A	140297
3	5000	250	TRANSPARENT	30°	A	140389

MODO MINI LED Q

IP67 | IK10 | 

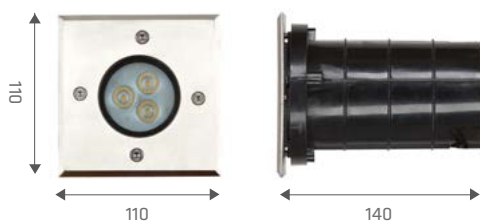

0,80  KG

rated power [W]	colour temperature [K]	total luminous flux* [lm]	diffuser	beam angle	EEL	index
3	3000	200	TRANSPARENT	15°	A	140426
3	4000	220	TRANSPARENT	15°	A	140303
3	5000	250	TRANSPARENT	15°	A	140433
3	3000	200	TRANSPARENT	30°	A	140471
3	4000	220	TRANSPARENT	30°	A	140310
3	5000	250	TRANSPARENT	30°	A	140488

MODO MINI LED O LED COLORS IP67 | IK10 |

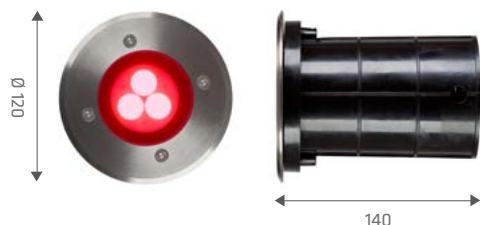

0,75  KG

rated power [W]	diffuser	beam angle	LED diode colour	index
3	TRANSPARENT	15°	RED	140341
3	TRANSPARENT	30°	RED	140396
3	TRANSPARENT	15°	BLUE	140365
3	TRANSPARENT	30°	BLUE	140419
3	TRANSPARENT	15°	GREEN	140358
3	TRANSPARENT	30°	GREEN	140402

MODO MINI LED Q COLORS IP67 | IK10 |

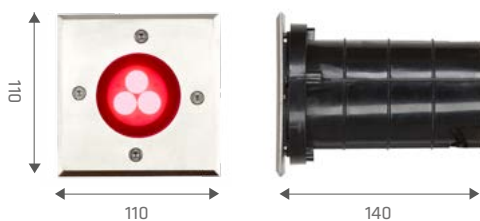

0,80  KG

rated power [W]	diffuser	beam angle	LED diode colour	index
3	TRANSPARENT	15°	RED	140440
3	TRANSPARENT	30°	RED	140495
3	TRANSPARENT	15°	BLUE	140464
3	TRANSPARENT	30°	BLUE	140549
3	TRANSPARENT	15°	GREEN	140457
3	TRANSPARENT	30°	GREEN	140532

* Initial, tolerance +/- 10%

During fixing into the ground, follow the mounting instruction precisely. Do not mount in pedestrian passageways.

PILLAR LED

ACCENT LIGHTING

POWER
LED



SPECIFICATION

Ingress protection class:	IP54
Total luminous flux*:	max. 700lm (5000K)
Colour temperature (CCT):	4000K, 5000K
Energy efficiency class (EEI):	A
Power supply:	220-240V / 50-60Hz
Mounting:	surface
Body:	powder coated aluminium
Diffuser:	tempered glass

Energy-saving, outdoor accent fitting with a power of 1x9W and 2x9W provides economical and long-term operation without replacing light sources. Dustproof and waterproof luminaire with an ingress protection class IP54, protected against dust and drops of water falling at any angle. Ingress protection class is provided by its design - aluminium body and tempered glass, additionally secured with a seal. Available in two light distribution options: 10° and 30°. Specification: temperature: 4000K, 5000K; light colour white, and optionally: red, blue and green.

LIGHT BEAM CURVES

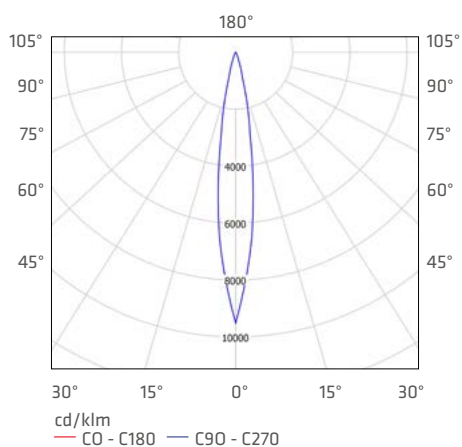

APPLICATION

The fitting for wall mounting (directly on the surface using dowels) designed specifically for outdoor accent lighting of building facades such as: hotels, offices, apartment buildings, but also private houses, passageways and exit areas.

PILLAR LED

ACCENT LIGHTING

PILLAR LED 1X9W

IP54 | 



2,70  KG

rated power [W]	colour temperature [K]	total luminous flux* [lm]	beam angle	colour	diffuser	EEL	index
1x9	4000	630	10°	BLACK	TRANSPARENT	A	350191
1x9	4000	630	10°	GREY	TRANSPARENT	A	350078
1x9	4000	630	30°	BLACK	TRANSPARENT	A	350252
1x9	4000	630	30°	GREY	TRANSPARENT	A	350139
1x9	5000	700	10°	BLACK	TRANSPARENT	A	350207
1x9	5000	700	10°	GREY	TRANSPARENT	A	350085
1x9	5000	700	30°	BLACK	TRANSPARENT	A	350269
1x9	5000	700	30°	GREY	TRANSPARENT	A	350146

PILLAR LED 2X9W

IP54 | 



2,80  KG

rated power [W]	colour temperature [K]	total luminous flux* [lm]	beam angle	colour	diffuser	EEL	index
2x9	4000	2x600	10°	BLACK	TRANSPARENT	A	350443
2x9	4000	2x600	10°	GREY	TRANSPARENT	A	350313
2x9	4000	2x600	30°	BLACK	TRANSPARENT	A	350504
2x9	4000	2x600	30°	GREY	TRANSPARENT	A	350375
2x9	5000	2x670	10°	BLACK	TRANSPARENT	A	350450
2x9	5000	2x670	10°	GREY	TRANSPARENT	A	350320
2x9	5000	2x670	30°	BLACK	TRANSPARENT	A	350511
2x9	5000	2x670	30°	GREY	TRANSPARENT	A	350382

* Initial, tolerance +/- 10%

Available options: LED diode colour - red, blue, green.



PILLAR MINI LED

ACCENT LIGHTING

POWER
LED



SPECIFICATION

Ingress protection class:	IP54
Total luminous flux*:	max. 250lm (5000K)
Colour temperature (CCT):	3000K, 4000K, 5000K
Energy efficiency class (EEI):	A
Power supply:	220-240V / 50-60Hz
Mounting:	surface
Body:	powder coated aluminium
Diffuser:	tempered glass

Outdoor facade LED luminaire with a power of 1x3W and 2x3W provides economical and long-term operation without replacing light sources. Luminaire with the IP54 parameter is dustproof and provides protection against drops of water falling at any angle from all sides. Ingress protection class is provided by its design - aluminium body and tempered glass, additionally secured with a seal. Available in two light distribution options: 15° and 30°. Specification: temperature 3000K, 4000K, 5000K; light colour white, and optionally: red, blue and green.

LIGHT BEAM CURVES

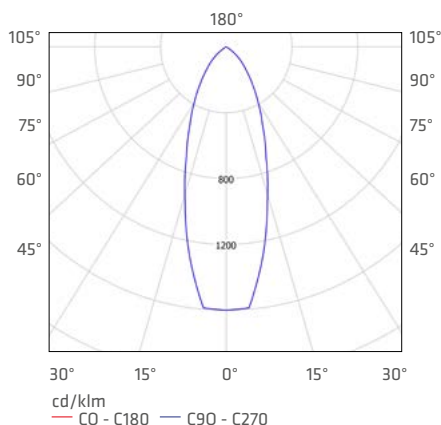

APPLICATION

The fitting for wall mounting (directly on the surface using dowels) is designed specifically for outdoor accent lighting of building facades such as: hotels, offices, apartment buildings, but also private homes, passageways and exit areas.

PILLAR MINI LED

ACCENT LIGHTING

PILLAR MINI LED

IP54 | 



rated power [W]	colour temperature [K]	total luminous flux* [lm]	beam angle	colour	diffuser	EEL	index
3	3000	200	15°	BLACK	TRANSPARENT	A	351105
3	3000	200	15°	GREY	TRANSPARENT	A	351006
3	3000	200	30°	BLACK	TRANSPARENT	A	351150
3	3000	200	30°	GREY	TRANSPARENT	A	351051
3	4000	220	15°	BLACK	TRANSPARENT	A	356186
3	4000	220	15°	GREY	TRANSPARENT	A	356216
3	4000	220	30°	BLACK	TRANSPARENT	A	356247
3	4000	220	30°	GREY	TRANSPARENT	A	356278
3	5000	250	15°	BLACK	TRANSPARENT	A	351112
3	5000	250	15°	GREY	TRANSPARENT	A	351013
3	5000	250	30°	BLACK	TRANSPARENT	A	351167
3	5000	250	30°	GREY	TRANSPARENT	A	351068
2x3	3000	2x200	15°	BLACK	TRANSPARENT	A	351310
2x3	3000	2x200	15°	GREY	TRANSPARENT	A	351211
2x3	3000	2x200	30°	BLACK	TRANSPARENT	A	351365
2x3	3000	2x200	30°	GREY	TRANSPARENT	A	351266
2x3	4000	2x220	15°	BLACK	TRANSPARENT	A	356193
2x3	4000	2x220	15°	GREY	TRANSPARENT	A	356223
2x3	4000	2x220	30°	BLACK	TRANSPARENT	A	356254
2x3	4000	2x220	30°	GREY	TRANSPARENT	A	356285
2x3	5000	2x250	15°	BLACK	TRANSPARENT	A	351327
2x3	5000	2x250	15°	GREY	TRANSPARENT	A	351228
2x3	5000	2x250	30°	BLACK	TRANSPARENT	A	351372
2x3	5000	2x250	30°	GREY	TRANSPARENT	A	351273

0,5  KG

PILLAR MINI N LED

IP54 | 



rated power [W]	colour temperature [K]	total luminous flux* [lm]	beam angle	colour	diffuser	EEL	index
3	3000	200	15°	BLACK	TRANSPARENT	A	351518
3	3000	200	15°	GREY	TRANSPARENT	A	351419
3	3000	200	30°	BLACK	TRANSPARENT	A	351563
3	3000	200	30°	GREY	TRANSPARENT	A	351464
3	4000	220	15°	BLACK	TRANSPARENT	A	356209
3	4000	220	15°	GREY	TRANSPARENT	A	356230
3	4000	220	30°	BLACK	TRANSPARENT	A	356261
3	4000	220	30°	GREY	TRANSPARENT	A	356292
3	5000	250	15°	BLACK	TRANSPARENT	A	351525
3	5000	250	15°	GREY	TRANSPARENT	A	351426
3	5000	250	30°	BLACK	TRANSPARENT	A	351570
3	5000	250	30°	GREY	TRANSPARENT	A	351471

0,35  KG

* Initial, tolerance +/- 10%

UP LED

ACCENT LIGHTING

LED GO!

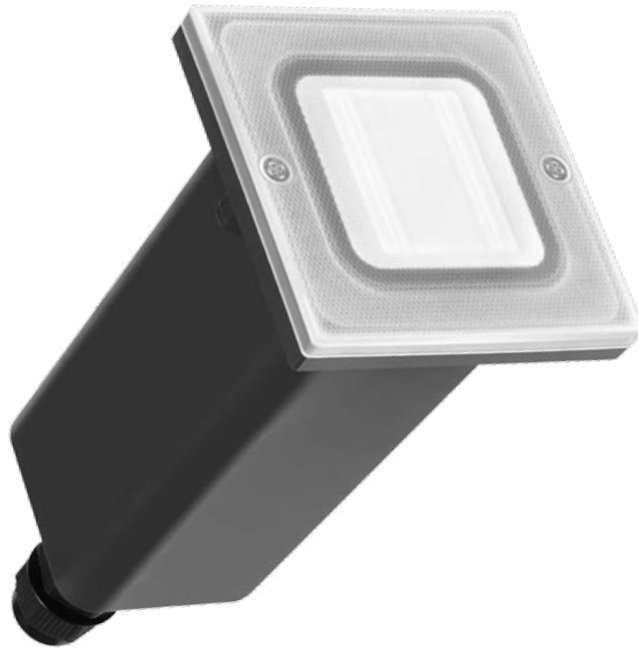

SPECIFICATION

Ingress protection class:	IP65
Impact resistance:	IK07
Total luminous flux*:	max. 240lm (4000K)
Colour temperature (CCT):	3000K, 4000K
Energy efficiency class (EEL):	A+
Power supply:	220-240V / 50-60Hz
Mounting:	into the ground (mounting box included)
Diffuser:	PC PRM
Body:	PC

Energy-saving, outdoor 2W accent fitting provides economical and long-term operation without replacing light sources. Dustproof and waterproof luminaire with an ingress protection class of IP65, protected against dust and water splashing from a nozzle directed at any angle. Available with asymmetrical light distribution. Specification: colour temperature of the LED light source: 3000K, 4000K.

LIGHT BEAM CURVES

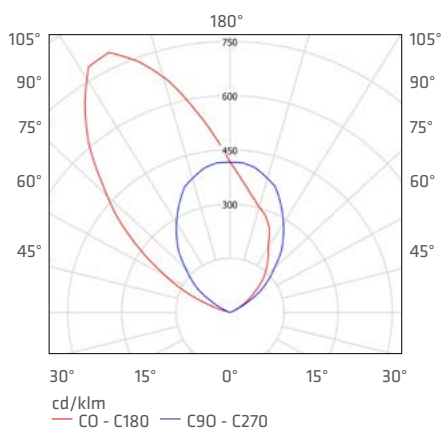

APPLICATION

Outdoor luminaire intended to illuminate facades, stairs, alcoves, pillars and greenery in gardens, parks and recreational facilities.

MOUNTING INTO THE GROUND

UP LED

IP65 | IK08 | 

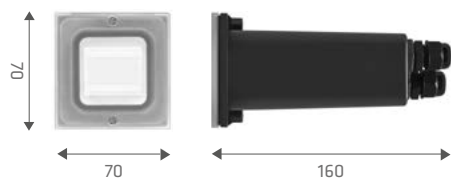

0,21  KG

rated power [W]	colour temperature [K]	total luminous flux* [lm]	diffuser	EEl	index
2	3000	220	PRM	A+	903014
2	4000	240	PRM	A+	903007

RECESSED MOUNTING

UP LED

IP65 | IK07 | 

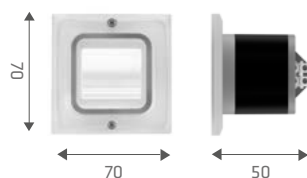

0,23  KG

rated power [W]	colour temperature [K]	total luminous flux* [lm]	diffuser	EEl	index
2	3000	220	PRM	A+	903038
2	4000	240	PRM	A+	903021

Mounting in classic installation box Q 60

* Initial, tolerance +/- 10%

MINI LED

ACCENT LIGHTING

POWER
LED



SPECIFICATION

Ingress protection class:	IP65	Energy-saving, outdoor accent fitting with a power of 1W provides economical and long-term operation without replacing light sources. High ingress protection class IP65 and high impact resistance IK08. Available in two light distribution options: symmetrical and asymmetrical. Specification: colour temperature 3000K, 5000K.
Impact resistance:	IK08	
Colour temperature (CCT):	3000K, 5000K	
Energy efficiency class (EEL):	A	
Power supply:	220-240V / 50-60Hz	
Mounting:	recessed, into the ground (mounting box included)	
Ring:	powder-coated cast	
Diffuser:	tempered glass	
Body:	plastic, aluminium	

LIGHT BEAM CURVES

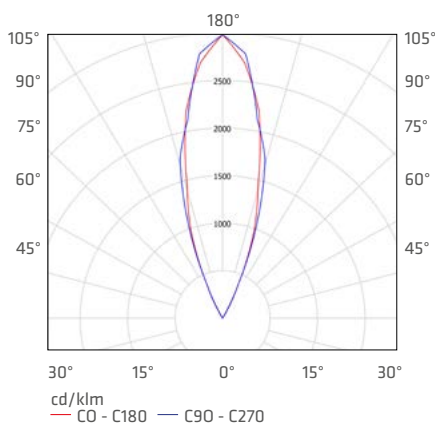

APPLICATION

Ideal for indoor and outdoor use to illuminate facades, stairs, alcoves, pillars and greenery in gardens, parks and recreational facilities.



MINI LED

ACCENT LIGHTING

MINI LED

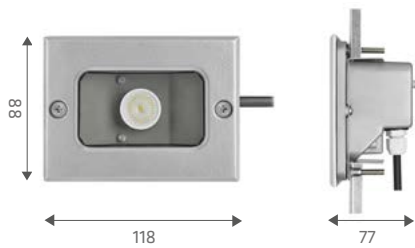
IP65 | IK08 | 



80/110 
0,30 

rated power [W]	colour temperature [K]	light distribution	EEl	index
1	3000	ASYMETRICAL	A	139604
1	5000	ASYMETRICAL	A	139611
1	3000	SYMETRICAL	A	139628
1	5000	SYMETRICAL	A	139635

MOUNTING INTO THE GROUND

MINI LED

IP65 | IK08 | 



80/113 
0,32 

rated power [W]	colour temperature [K]	light distribution	EEl	index
1	3000	ASYMETRICAL	A	139550
1	5000	ASYMETRICAL	A	139567
1	3000	SYMETRICAL	A	139574
1	5000	SYMETRICAL	A	139581

* Initial, tolerance +/- 10%



BILEO LED

ACCENT LIGHTING

LED



SPECIFICATION

Ingress protection class:	IP65
Power supply:	220-240V / 50-60Hz
Mounting:	recessed (mounting box included)
Body:	aluminium
Diffuser:	PC TRANSPARENT

Energy-saving, outdoor accent fitting provides economical and long-term operation without replacing light sources. Dustproof and waterproof fitting with an ingress protection class IP65, protected against dust and water splashing from a nozzle directed at any angle.

LIGHT BEAM CURVES

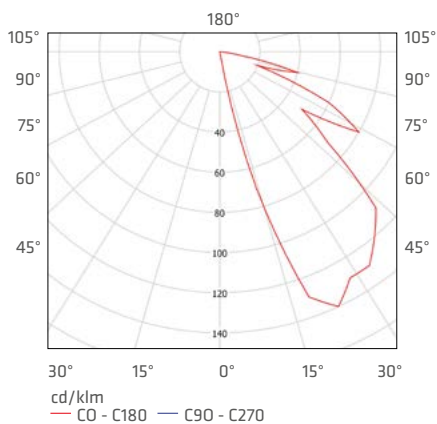

APPLICATION

Outdoor luminaire designed to illuminate stairs, alcoves, posts, garage entrances, entry areas.

BILEO LED

ACCENT LIGHTING

BILEO LED A

IP65 

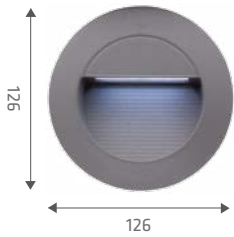

∅ 112 

0,3 

rated power [W]	diffuser	light colour	depth [mm]	index
0,8	TRANSPARENT	WHITE	65,5	329005
0,8	TRANSPARENT	BLUE	65,5	329029

BILEO LED B

IP65 

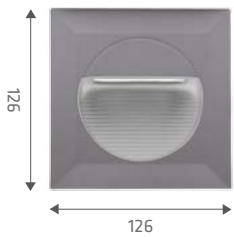

112/112 

0,3 

rated power [W]	diffuser	light colour	depth [mm]	index
0,8	TRANSPARENT	WHITE	65,5	329104
0,8	TRANSPARENT	BLUE	65,5	329128

BILEO LED C

IP65 

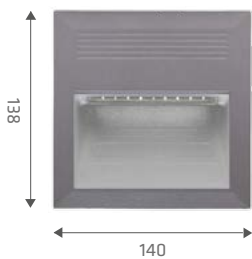

122/117 

0,5 

rated power [W]	diffuser	light colour	depth [mm]	index
1	TRANSPARENT	WHITE	94	329203
1	TRANSPARENT	BLUE	94	329227





LENA
LIGHTING



LIGHTING CONTROL

LIGHTING CONTROL

MODERN LIGHTING SOLUTIONS

CORRIDOR

Dual stream fittings
Emergency fittings
RCR sensor

OUTDOOR

Street lighting
Different configurations
of distribution
Facade lighting

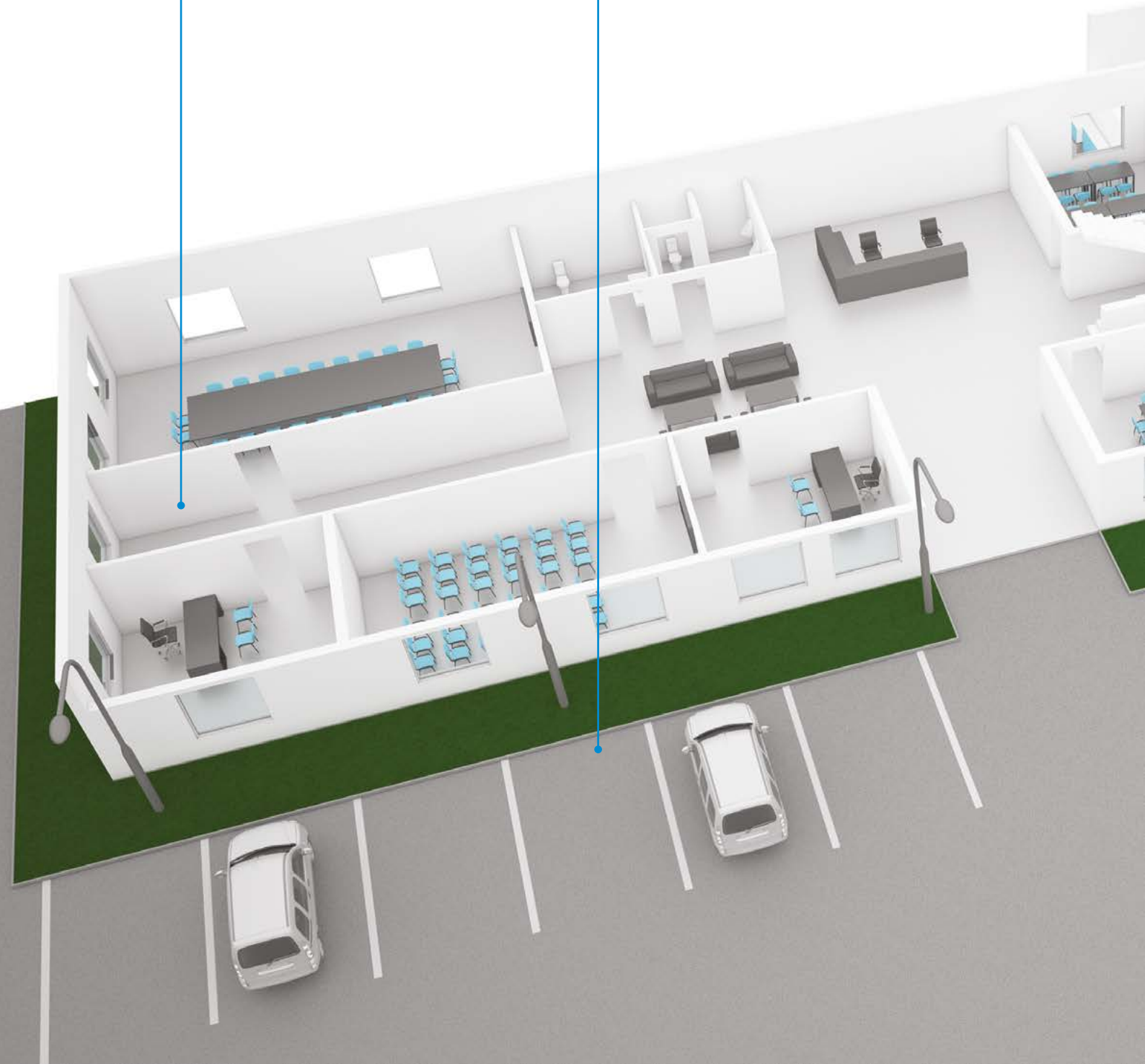

OFFICE

Coffer fittings
Suspended fittings
iDIMM/DALI technology
1-10V CONTROL

WAREHOUSE

Industrial fitting
DALI technology

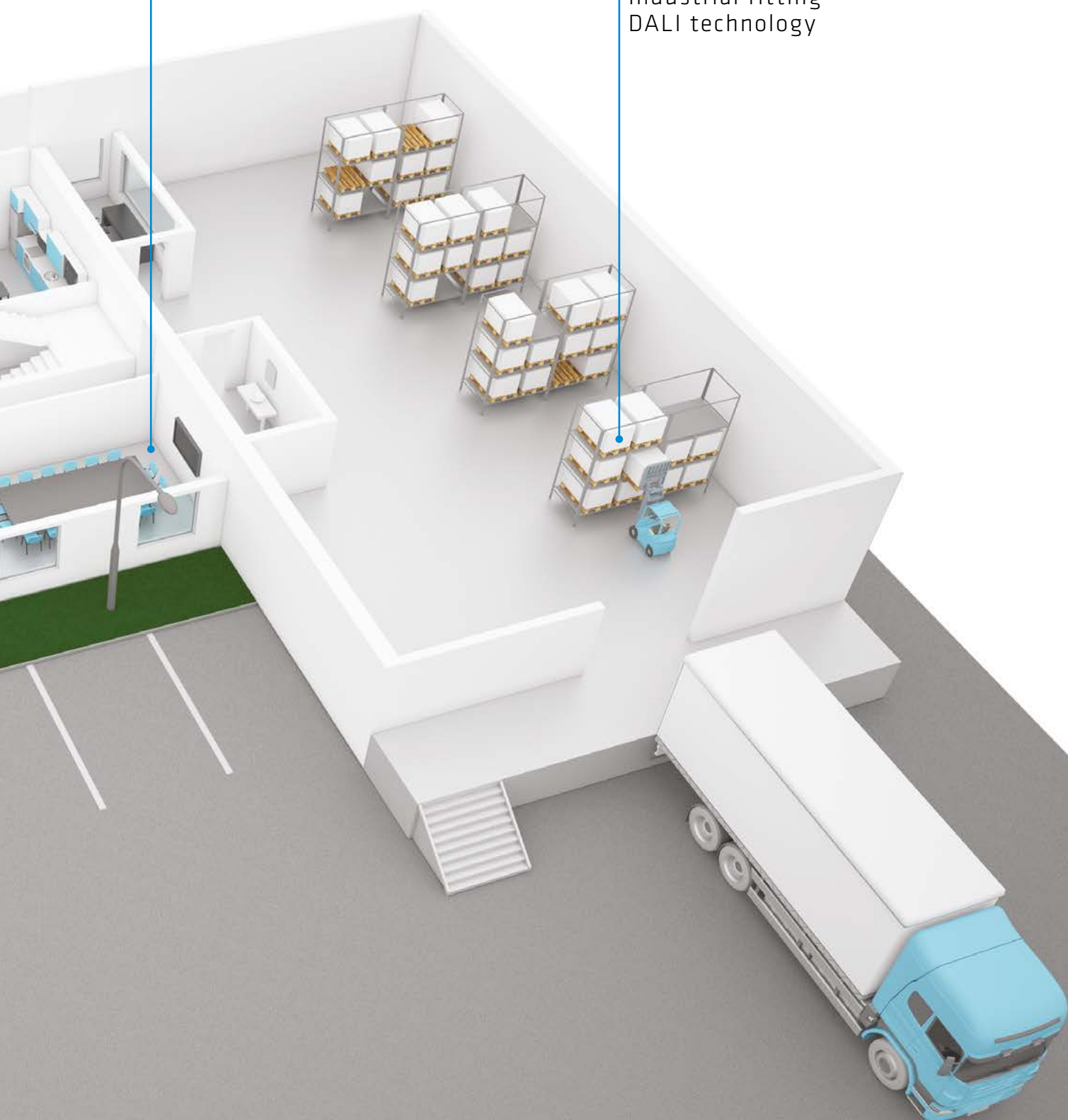

LIGHTING CONTROL

MODERN LIGHTING SOLUTIONS

DALI MASTER CONTROL SYSTEM - EQUIPMENT

PIR

Passive infrared sensor (PIR) is a presence detector that reacts to motion. Each work mode has a smart setting of time delay which can be changed if needed. The mechanical snubber of the sensor determines the appropriate range area. Testing the PIR (reaching the sensor's range) allows to check fast if the system works properly.

CL

The constant light intensity sensor (CL) regulates the flow of artificial light depending on changes of the natural light. The default levels of light intensity, time and even light distribution (offset) can be changed if needed.

RC

The infrared receiver (IR) allows advanced programming, testing and it enables remote and computer control.

FL

The purpose of FL (Fixed Light) is to maintain a fixed light beam during the system's operation, unless the sensor detects the presence of people. Fixed light beam luminaires will be switched off. If necessary, the values can be modified manually.

PROGRAMMING MODES FOR THE DALI MASTER SYSTEM

CLASSROOM



CL + Offset
PIR ON: manual OFF: automat.
15 min → 20%
30 sec → off
Fade out light

OFFICE



CL + Offset
PIR ON: automat. OFF: automat.
15 min → 20%
30 sec → off
Fade out light

MULTIPOSITION OFFICE



CL + Offset
PIR ON: manual OFF: automat.
15 min → 20%
60 min → off
Fade out light

CORRIDOR FUNCTION



FL
PIR ON: automat. OFF: automat.
5 min → 20%
30 min → off
Fade out light

CORRIDOR MAINTENANCE



CL
PIR ON: automat. OFF: automat.
15 min → 20%
30 sec → off
Fade out light

CONFERENCE ROOM



CL +
FL
PIR ON: manual OFF: automat.
15 min → 20%
30 sec → off
Fade out light

DALI MASTER / DALI CONTROL

Diagram on the example of SMART LED luminaires. Luminaires operating in this system are connected in groups and one of them (master) is armed with a motion sensor that activates the whole group (slave luminaires). This solution was introduced to optimize the work of adjacent sensors and investment costs. The master-slave system is particularly useful in lighting offices, large stores, schools, hospitals.

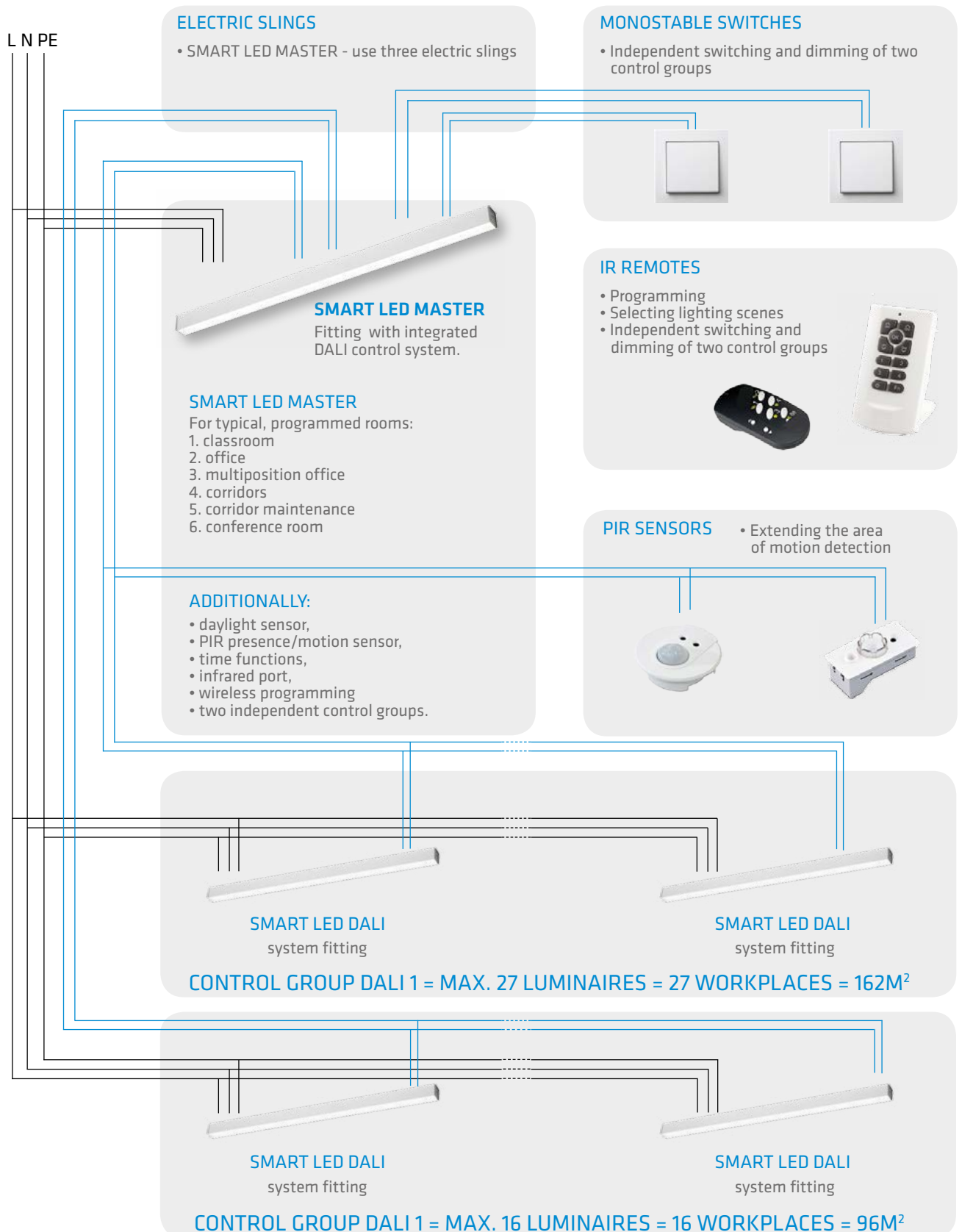

LIGHTING CONTROL

MODERN LIGHTING SOLUTIONS

The smallest patented RCR sensor in the world!

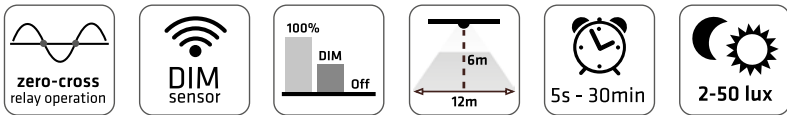

Range specification

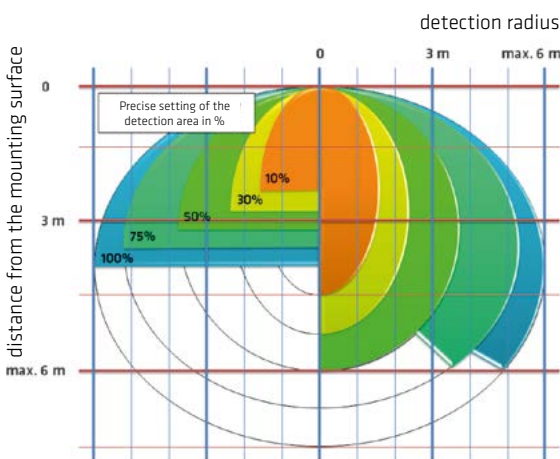

A transmitter detecting the crossing of point 0

The sensor contains a transmitter which precisely switches on/off in zero points of the AC sine wave. This ensures minimum current at the contact points of the transmitter, the maximum load capacity and lifespan of the product.

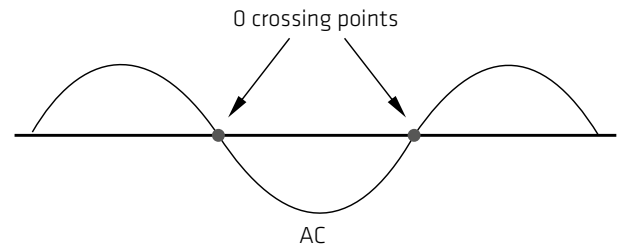

Technical data

Nominal voltage:	220-240V
Ingress protection class:	IP20
Maximum load:	Max. 800W (resistive), max. 400W (induction)
Power consumption in stand-by:	0,5W
Start time:	20s
Radio range:	10/50/75/100%
Hold time:	30'/20'/10'/5'/1'/30s/5s
Detection range	100/75/50/30/10
Dusk sensor:	50/20/5/2/lux
Microwave transmitter power:	5,8GHz+/-75MHz
Detection angle:	Max. (oxH): 12m x 6m
Mounting height:	Max. 6m
Operating temperature range	-35°C do +70°C
Certificates:	Semko, EMC, CE, R&TTE

The RCR sensor is a motion switch, turn on the light on detection of people movement, and turn off after a pre-selected holdtime when there is no people around. A daylight sensor is also built-in to switch off the light when there is sufficient natural light.

OPERATION

- With sufficient natural light, the light does not switch on when presence detected.
- With insufficient natural light, the sensor switches on the light automatically when person enters the room.
- After the hold time, then switch off automatically when no movement is detected.

ZERO-CROSS RELAY OPERATION

Designed in the software, sensor switches on/off the load right on the zero-cross point, to ensure the min. current passing through the relay contact point, and enable the max. load and life-time of the relay.

SETTINGS

Detection area:

- Detection area can be reduced by selecting the combination on the DIP switches to fit precisely for each specific application: 10/25/50/75/100%, can be customized.
- Detection angle: 30° ~ 150°
- Mounting height: Max. 6m
- Detection range: Max. (oxH): 12m x 6m

Hold-time

Hold-time means the time period you would like to keep the lamp on 100% after the person has left the detection area: 5s/30s/1min/5min/10min/20min/30min, can be customized.

Daylight sensor

The daylight threshold can be set on DIP switches, to fit for particular application: 2; 5; 20; 50lux; disable.

- “daylight” : The lamp works always, even during daylight.
- “twilight” : The lamp works only in twilight .
- “darkness”: The lamp works only in darkness.

CORRIDOR FUNCTION

The basis of operation of a dual stream luminaire (with the so-called “corridor function”) is the use of two-circuit architecture or a dimmable ballast in combination with a motion sensor. In both cases the fitting operates in a 10/100 system: in the “off” mode the device continuously emits 10% of its nominal light stream intensity, and once movement is detected it fluidly switches to the “on” mode (100% light intensity). The corridor function is particularly well suited for locations where a continuous, minimal illumination of the monitored surface is required.

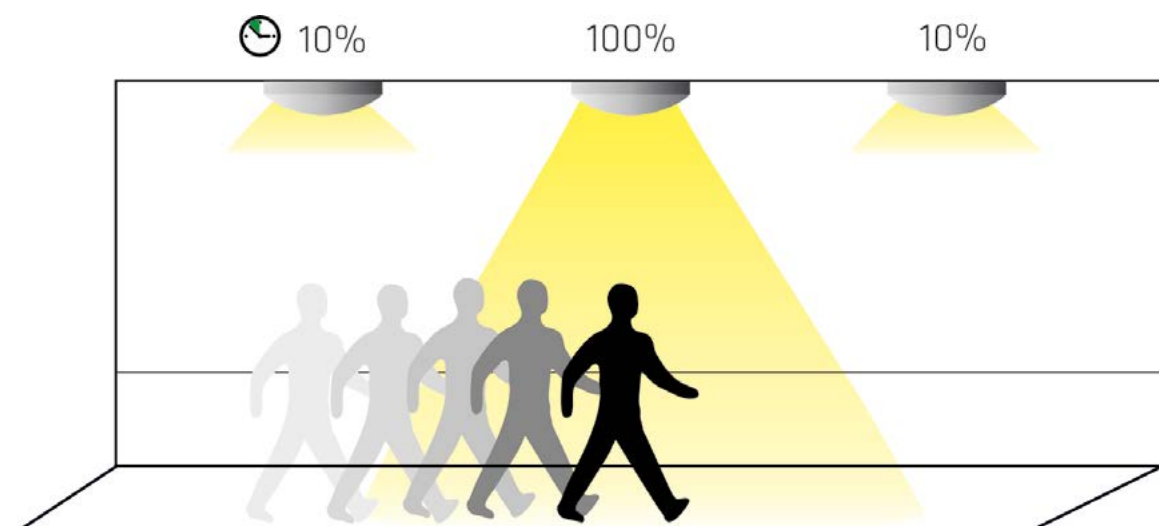

LIGHTING CONTROL

MODERN LIGHTING SOLUTIONS

1-10V CONTROL

Most LED GO fittings may be equipped with a DIMM 1-10V dimmable ballast. In order to fully utilize the possibilities offered by the LED GO! light sources you need to connect them to the DALI digital lighting control system.

The DALI protocol enables digital control over light sources depending on the external conditions. This allows you to control each light source individually or in groups, thus maximizing your savings without affecting the lifespan of LEDs.



ENA
LIGHTING





POLISH MANUFACTURER - GUARANTEE OF
QUALITY AND AVAILABILITY OF PRODUCTS.

SYMBOLS

IP66 | ingress protection class

IK10 | impact resistance class

 | insulation class 1

 | insulation class 2

 | mounting dimensions

 | mounting dimensions

 | weight

Photos presented in the catalogue are illustrative and may differ from a real product appearance. Manufacturer reserves its right to change technical data of products without prior information.

Date of publication: 17.08.2016



2017

LED GO!