

# KYORITSU

## Test and Measuring Instruments

Catalogue 2015 - 2016

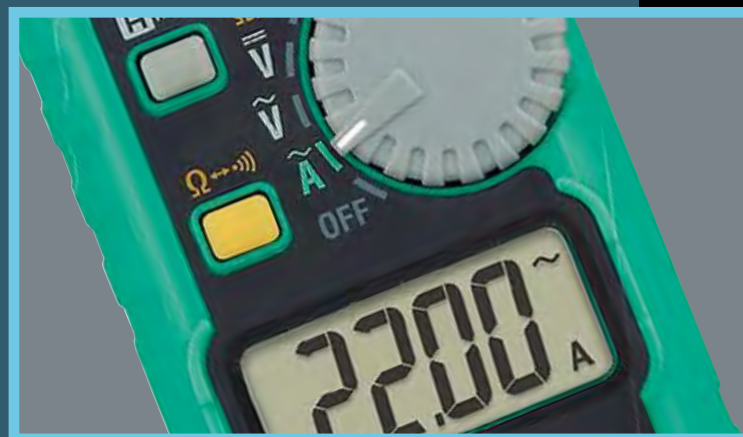

*Japan*  
QUALITY



Quality and reliability is our tradition

**KYORITSU**



*This year, May 2015, we can celebrate our 75th Anniversary since the founder started "Kyoritsu Electric Laboratory".*

*"Quality and reliability is our tradition."*

*Since the foundation, Kyoritsu has been trying to make our customer satisfied by providing high quality products and services. We are proud that the motto have been succeeded by Kyoritsu employees for 75 years.*

*State of the art electrical measuring equipments are the backbone of our company's business. Our wide product-line of testers has contributed to technological developments and industrial infrastructures worldwide.*

*Also, we recognize the importance of being responsible with regard to global-environmental issues that affect all of us. It is our sincere hope, not only to sustain our business development but also look at the future for next generation.*

*Kyoritsu pledges to embrace technologies and manufacturing processes that will contribute to environmental solutions.*

*On behalf of all the Kyoritsu employees and business partners, thank you for your patronage.*

*We will be happy if our products make your life happier.*

Masamichi Kuramoto  
President

倉本昌道

































### **CL-65**

KYORITSU developed the first clamp type AC ammeter in Japan in 1959



# CONTENTS

## SYMBOLS

	TRUE RMS
	CAT IV 600V
	DC/AC V
	DC/AC A
	DC Voltage
	AC Voltage
	DC+AC measurement
	MAX MIN AVG
	MAX MIN
	Resistance
	Continuity buzzer
	Diode
	Capacitance
	Temperature
	Frequency
	Decibel
	Duty cycle ratio
	Back light
	Water proof
	Peak hold
	Data hold
	Auto power off
	Auto power save
	Output
	Filter
	Relative
	External Power Supply
	USB
	Low power Ω
	Bluetooth

## MULTIMETERS

1009, 1011/1012, 1018/1018H, 1019R, 1021R, 1030, 1051/1052, 1061/1062, 1109S, 1110, 2000/2001, 2012R

P.8 - P.15

## CLAMP METERS

2002PA/2002R, 2003A, 2007A, 2009R, 2010, 2017, 2027, 2031, 2033, 2040, 2046R, 2055/2056R, 2200/2200R, 2210R, 2300R, 2412, 2413F/2413R, 2431, 2432, 2433/2433R, 2434, 2500, 2608A, 8008, 8112/8112BNC, 8115

P.16 - P.27

## INSULATION TESTERS

3005A, 3007A, 3021/3022/3023, 3025A/3125A/3126, 3121B/3122B, 3123A, 3124, 3127, 3128, 3131A, 3132A, 3161A, 3165/3166

P.28 - P.39

## EARTH TESTERS

4102A, 4105A, 4106, 4200/4202, 4300

P.40 - P.43

## LOOP/PSC/RCD TESTERS

4118A, 4140, 5406A, 5410

P.44 - P.47

## PORTABLE APPLIANCE TESTERS

6201A

P.48

## MULTI FUNCTION TESTERS

6010B, 6011A, 6016, 6018

P.49 - P.53

## POWER METERS

6305, 6315

P.54 - P.59

## LOGGERS

5010/5020

P.60 - P.61

## SENSORS

8115, 8121, 8122, 8123, 8124, 8125, 8126, 8127, 8128, 8129, 8130, 8141, 8142, 8143, 8146, 8147, 8148, 8309

P.62 - P.65

## OTHERS

5201, 5202, 5510, 8030, 8031/8031F, 8035

P.66 - P.67

## KEWTECH

KT170/171, KT200, KT203

P.68 - P.69

## ACCESSORIES

Test Leads

P.70 - P.75

## GLOSSARY/PRODUCT INDEX/QUALITY CONTROL CONCEPT

P.76 - P.81



## Safety Warnings

Please read the "Safety Warnings" in the instruction manual supplied with the instrument thoroughly and completely for safety use. Failure to follow the safety rules can cause fire, trouble, electrical shock, etc. Therefore, make sure to operate the instrument on a correct power supply and voltage rating marked on each instrument.

MULTIMETERS

CLAMP METERS

INSULATION TESTERS

EARTH TESTERS

LOOP/PSC/RCD TESTERS

PORTABLE APPLIANCE TESTERS

MULTI-FUNCTION TESTERS

POWER METERS

LOGGERS

SENSORS

OTHERS

KEWTECH

ACCESSORIES

GLOSSARY  
PRODUCT INDEX  
QUALITY CONTROL CONCEPT

# KYORITSU LINE UP

## ANALOGUE MULTIMETERS

## DIGITAL MULTIMETERS

KEW 1109S

MODEL 1110

MODEL 1009

KEW 1011/1012

KEW 1018/1018H

KEW 1019R



P11

P11

P11

P11

P12

P12

CE

CE

CE  
1012  
TRUE  
RMS

CE

CE

NEW

## ANALOGUE CLAMP METERS

## DIGITAL CLAMP METERS

MODEL 2608A

MODEL 2002PA  
MODEL 2002R

MODEL 2007A

MODEL 2017

MODEL 2027

MODEL 2031

KEW 2040



P19

P19

P19

P20

P20

P20

P21

CE  
Φ33  
MAX  
AC 300A

CE  
2002R  
TRUE  
RMS  
Φ55  
MAX  
AC 2000A

CE  
Φ33  
MAX  
AC 600A

CE  
Φ33  
MAX  
AC 600A

CE  
TRUE  
RMS  
Φ33  
MAX  
AC 600A

CE  
Φ24  
MAX  
AC 200A

CE  
Φ33  
MAX  
AC 600A

## DIGITAL CLAMP METERS

## LEAKAGE CLAMP METERS

KEW 2046R

KEW 2055/2056R

KEW 2500

MODEL 2300R

MODEL 2412

KEW 2413F/2413R



P23

P23

P24

P24

P26

P26

CE  
TRUE  
RMS  
Φ33  
MAX  
AC/DC 600A

CE  
2056R  
TRUE  
RMS  
Φ40  
MAX  
AC/DC 100A

CE  
Φ6

CE  
TRUE  
RMS  
Φ10  
MAX  
AC/DC 100A

Φ40  
MAX  
AC 500A

CE  
2413R  
TRUE  
RMS  
Φ68  
MAX  
AC 1000A

## ANALOGUE INSULATION/CONTINUITY TESTERS

## ANALOGUE INSULATION TESTERS

KEW 3021-3023

MODEL 3131A

MODEL 3132A

MODEL 3161A

MODEL 3165/3166

KEW 3121B/3122B



P31

P32

P32

P33

P33

P38

CE  
3021(125V/250V/500V/1000V)  
3022(50V/100V/250V/500V)  
3023(100V/250V/500V/1000V)

CE  
3131A(250V/500V/1000V)

CE  
3132A(250V/500V/1000V)

CE  
3161A(15V/500V)

3165(500V)  
3166(1000V)

CE  
3121B(2500V)  
3122B(5000V)

NEW

## EARTH TESTERS

## EARTH CLAMP TESTER

## LOOP/PSC TESTERS

MODEL 4102A

KEW 4105A

KEW 4106

KEW 4300

MODEL 4200  
KEW 4202

MODEL 4118A

KEW 4140



P41

P41

P42

P42

P43

P44

P45

CE

CE

CE

CE  
TRUE  
RMS

CE  
TRUE  
RMS

CE

CE

## MULTI FUNCTION TESTERS

## POWER METERS

## LOGGERS

## OTHERS

MODEL 6018

KEW 6305

KEW 6315

KEW 5010/5020

MODEL 5201

MODEL 5202

MODEL 5510



P49

P58

P56

P60

P66

P66

P66

CE

CE  
TRUE  
RMS

CE  
TRUE  
RMS

NEW

CE  
TRUE  
RMS

CE

CE

CE



## DIGITAL MULTIMETERS

**KEW 1021R** P10  **NEW** CE TRUE RMS

**KEW 1030** P12  CE

**KEW 1051/1052** P14  CE TRUE RMS

**KEW 1061/1062** P14  CE TRUE RMS

**MODEL 2000** P13  CE

**MODEL 2001**  $\phi 6$  MAX AC/DC 20A  $\phi 10$  MAX AC/DC 10A

**KEWMATE 2012R** P13  CE TRUE RMS  $\phi 12$  MAX AC/DC 120A

## DIGITAL CLAMP METERS

**KEW 2200/2200R** P21  CE 2200R TRUE RMS  $\phi 33$  MAX AC 600A **NEW**

**KEW 2210R** P21  CE TRUE RMS  $\phi 150$  MAX 3000A **NEW**

**KEW 2003A** P22  CE  $\phi 55$  MAX AC/DC 2000A **NEW**

**KEW 2009R** P22  CE TRUE RMS  $\phi 55$  MAX AC/DC 2000A

**MODEL 2010** P22   $\phi 7.5$  MAX AC/DC 20A

**MODEL 2033** P23  CE  $\phi 24$  MAX AC/DC 300A

## LEAKAGE CLAMP METERS

## DIGITAL INSULATION/CONTINUITY TESTERS

**MODEL 2431** P25  CE  $\phi 24$  MAX AC 200A

**MODEL 2432** P25  CE  $\phi 40$  MAX AC 100A

**MODEL 2433/2433R** P25  CE 2433R TRUE RMS  $\phi 40$  MAX AC 400A

**MODEL 2434** P26  CE  $\phi 28$  MAX AC 100A

**MODEL 3005A** P30  CE  $\phi 3005A(250V/500V/1000V)$

**MODEL 3007A** P30  CE  $\phi 3007A(250V/500V/1000V)$

## HIGH VOLTAGE INSULATION TESTERS

**KEW 3123A** P36  3123A(5000/10000V)

**MODEL 3124** P37  3124(1k-10kV Variable)

**KEW 3025A/3125A** P39  CE 3125A(250/500/1000/2500/5000A) 3025A(250/500/1000/2500A) **NEW**

**KEW 3126** P39  CE 3126(500/1000/2500/5000V)

**KEW 3127** P35  CE 3127(250/500/1000/2500/5000V) **NEW**

**KEW 3128** P34  CE 3128(500/1000/2500/5000/10000/12000V)

## RCD TESTERS

## PORTABLE APPLIANCE TESTERS

## MULTI FUNCTION TESTERS

**MODEL 5406A** P46  CE

**KEW 5410** P47  CE

**KEW 6201A** P48  CE

**KEW 6010B** P50  CE

**MODEL 6011A** P51  CE

**KEW 6016** P52  CE

## OTHERS

## KEWTECH

**KEW 8035** P67  CE

**MODEL 8030** P67  CE

**MODEL 8031** P67  CE

**KEW 8031F** P67  CE

**KT 170/171** P69  CE

**KT 200/203** P68  CE  $\phi 30$  MAX AC 400A

## INDUSTRIAL

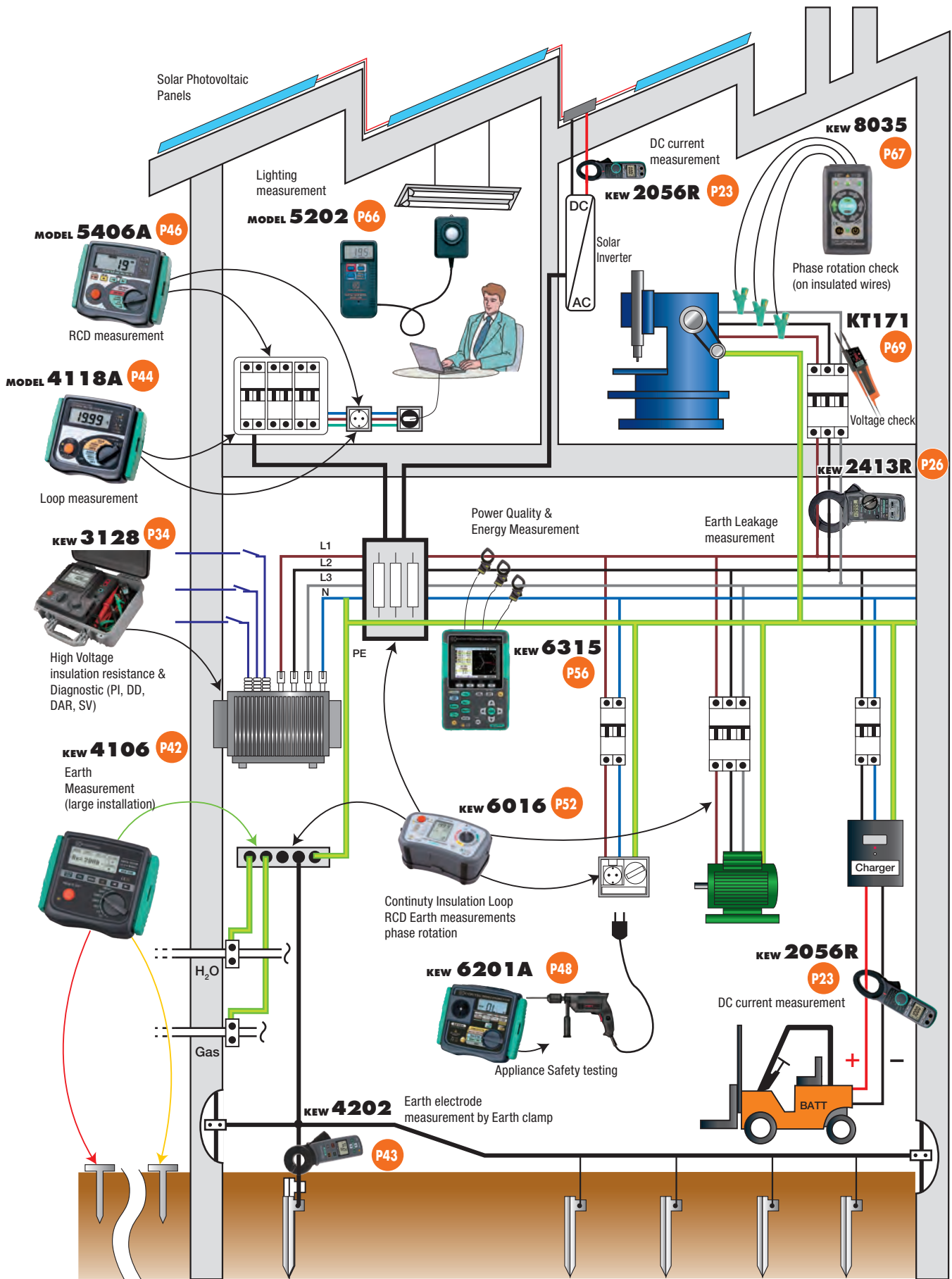



RESIDENTIAL

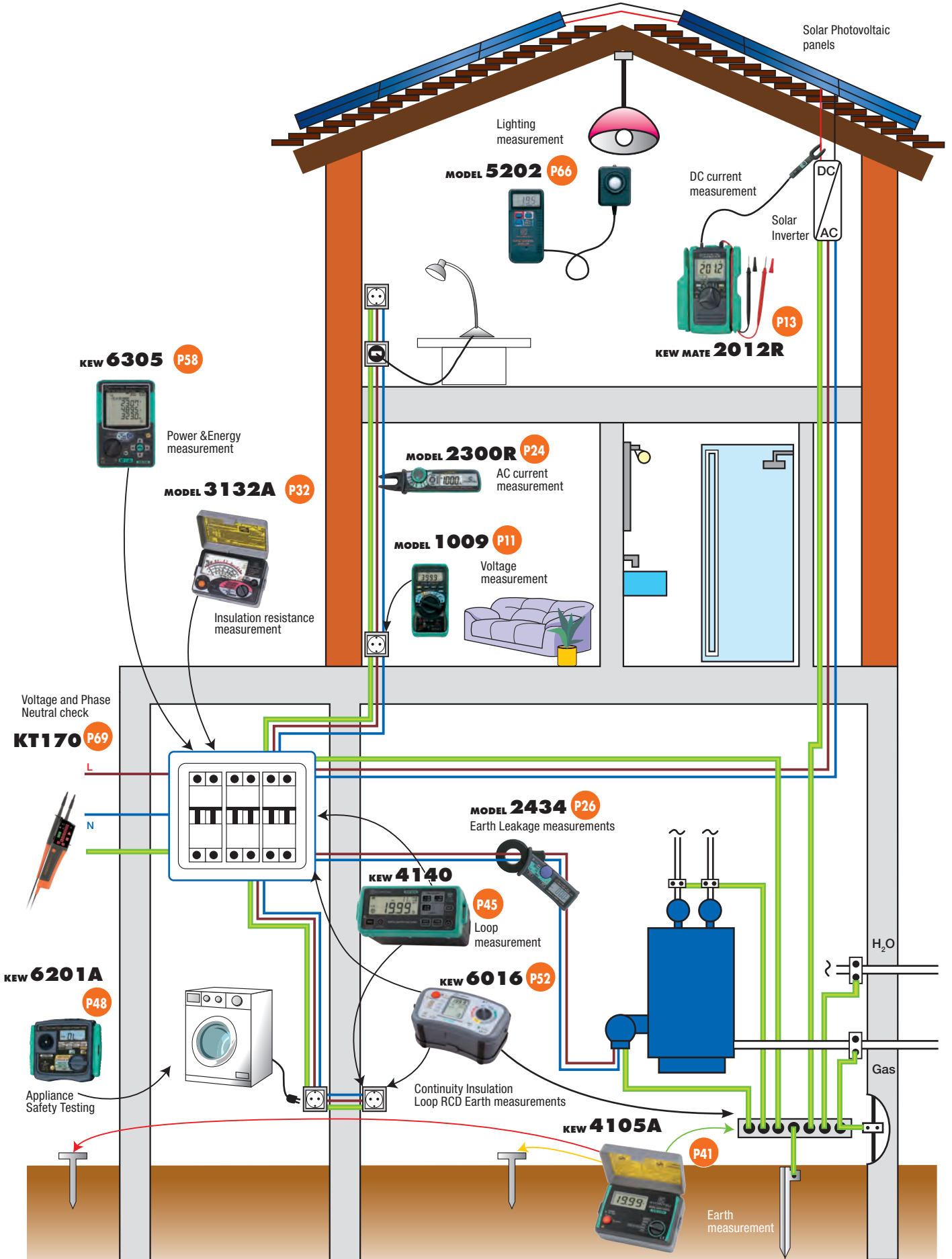

# MULTIMETERS





# MULTIMETERS

## Selection Guide of Multimeters

		Analogue Multimeters		Digital Multimeters									
		1109S	1110	1018 1018H	1019R	1021R	1030	1009	1011 1012	1051 1052	1061 1062	2000 2001	2012R
Appearance													
Detection method		-	-	-	✓	✓	-	-	✓ (1012)	✓	✓	-	✓
Maximum count display		-	-	4000	6000	6000	4000	4000	6000	6000	50000	3400	6000
DC Basic accuracy		±3% of FS	±3% of FS	0.8%	0.8%	0.5%	0.8%	0.6%	0.5%	0.09%	0.02%	1.5%	1.0%
Frequency response		30 - 20kHz	50 - 5kHz	50 - 400Hz	45 - 500Hz	40 - 500Hz	50 - 400Hz	50 - 400Hz	40 - 1kHz	40 - 1kHz	10 - 20kHz(1061) 10 - 100kHz(1062)	50 - 400Hz	45 - 400Hz
<b>Measurement</b>													
DC V	Max	1000V	600V	600V	600V	600V	600V	600V	600V	1000V	1000V	600V	600V
	Resolution	0.002V	0.005V	0.1mV	0.1mV	0.1mV	0.1mV	0.1mV	0.1mV	0.1mV	0.001mV	0.1mV	0.1mV
AC V	Max	1000V	600V	600V	600V	600V	600V	600V	600V	1000V	1000V	600V	600V
	Resolution	0.2V	0.2V	0.001V	0.001V	0.1mV	0.001V	0.1mV	0.001V	0.1mV	0.01mV(1061) 0.001mV(1062)	0.001V	0.001V
DCA	DC A	250mA	300mA	-	-	10A	-	10A	10A	10A	10A	60A(2000) 100A(2001)	120A
ACA	AC A	-	-	-	-	10A	-	10A	10A	10A	10A	60A(2000) 100A(2001)	120A
DC+AC	DC+AC	-	-	-	-	-	-	-	-	-	✓	-	-
Resistance	Ω	20MΩ	300KΩ	40MΩ	40MΩ	40MΩ	40MΩ	40MΩ	60MΩ	60MΩ	50MΩ	34MΩ	60MΩ
Continuity buzzer		-	✓	✓	✓	✓	✓	✓	✓	✓	✓	✓	✓
Battery test		-	✓	-	-	-	-	-	-	-	-	-	-
Diode test		-	-	✓	-	✓	✓	✓	✓	✓	✓	-	✓
Capacitance		-	-	200μF	600μF	1000μF	100μF	100μF	4000μF	1000μF	50mF	-	40μF
Frequency	Hz	-	-	10kHz	-	ACA 9.999kHz ACV 99.99kHz	200kHz	10MHz	10MHz	99.99kHz	99.99kHz	ACA 10kHz ACV 300kHz	ACA 400Hz ACV 300kHz
Duty cycle ratio	DUTY	-	-	✓	-	✓	✓	✓	✓	-	✓	-	-
Temperature	°C	-	✓	-	-	-	-	-	✓ (1011)	✓	✓	-	-
Decibel	dB	✓	-	-	-	-	-	-	-	-	✓	-	-
Low power-Ω	LP-Ω	-	-	-	-	-	-	-	-	-	✓ (1062)	-	-
<b>Function</b>													
Dual display		-	-	-	-	-	-	-	-	✓	✓	-	-
Bar graph		-	-	-	-	-	-	-	✓	✓	✓	✓	✓
Back light		-	-	-	-	✓	✓	-	-	✓	✓	-	-
Data hold	DATA HOLD	-	-	✓	-	✓	✓	✓	✓	✓	✓	✓	✓
Auto hold		-	-	-	-	-	-	-	-	✓	✓	-	-
Peak hold	PEAK HOLD	-	-	-	-	-	-	-	-	-	✓ (1062)	-	-
Max/Min/Ave	Max/Min Ave	-	-	-	-	✓ (No Ave)	-	-	✓ (No Ave)	✓ (1052)	✓	-	-
REL	REL	-	-	✓	✓	✓	✓	✓	✓	✓	✓	-	-
Manual memory		-	-	-	-	-	-	-	-	✓ (1052)	✓	-	-
Logging memory		-	-	-	-	-	-	-	-	✓ (1052)	✓	-	-
Communication	USB	-	-	-	-	-	-	-	-	✓ (1052)	✓	-	-
<b>Other</b>													
Operating temperature		0 - 40°C	0 - 40°C	0 - 40°C	0 - 40°C	0 - 40°C	0 - 40°C	0 - 40°C	0 - 40°C	-10 - 55°C	-20 - 55°C	0 - 40°C	0 - 40°C
Measurement categories		-	CAT III 300V CAT II 600V	CAT III 300V	CAT III 300V CAT II 600V	CAT IV 300V CAT III 600V	CAT III 600V	CAT III 300V	CAT III 300V CAT II 600V	CAT III 300V CAT IV 600V CAT III 1000V	CAT IV 600V CAT III 1000V	CAT III 300V CAT II 600V	CAT III 300V CAT II 600V
Power source		R6x2, 6F22x1	R6 x 2	LR-44 x 2	CR2032 x 1	R03 x 2	LR-44 x 2	R6 x 2	R6 x 2	R6 x 4	R6 x 4	R03 x 2	R03 x 2
Dimensions (L)x(W)x(D)mm		150x100x47	140x94x39	107x54x10	126x85x18	155x75x35	190x39x31	161x82x50	161x82x50	192x90x49	192x90x49	128x84x24(2000) 128x92x27(2001)	128x92x27
Weight(Approx.)		330g	280g	70g	135g	250g	100g	280g	280g	560g	560g	210g(2000) 220g(2001)	220g
Accessories	Test leads	7210A	7066A	-	-	7066A	-	7066A	7066A 8216(1011)	7220A	7220A	-	-
	Fuse	8901x2	8923x2	-	-	8919x1	-	8923x1 8919x1	8918x1 8919x1	8926x1 8927x1	8926x1 8927x1	-	-
	Case	-	9013	9115(1018) 9114(1018H)	-	9097	9130	-	-	-	-	-	-

# MULTIMETERS

## KEW 1021R NEW

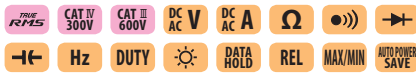

	1021R
DC V	6.000/60.00/600.0V(auto range) ±0.5%rdg±3dgt
DC mV	600.0mV ±1.5%rdg±3dgt
AC V	6.000/60.00/600.0V(auto range) ±1.3%rdg±3dgt(6/60V), ±1.0%rdg±3dgt [40 - 500Hz]
AC mV	600.0mV ±2.0%rdg±3dgt [40 - 500Hz]
DC A	6.000/10.00A(auto range) ±1.5%rdg±3dgt
AC A	6.000/10.00A(auto range) ±1.5%rdg±3dgt [40 - 500Hz]
Ω	600.0Ω/6.000/60.00/600.0kΩ/6.000/40.00MΩ (auto range) ±0.5%rdg±5dgt(600Ω), ±0.5%rdg±2dgt(6/60/600kΩ), ±1.5%rdg±5dgt(6MΩ), ±3.0%rdg±5dgt(40MΩ)
Continuity buzzer	600Ω (Buzzer sounds below 90Ω)
Diode test	2.0V Release Voltage: Approx.
Capacitance	60.00/600.0nF/6.000/60.00/600.0/1000μF ±2.0%rdg±15dgt(60n/600nF), ±5%rdg±10dgt(6μ/60μ/1000μF)
Frequency	ACV 99.99/999.9Hz/9.999 / 99.99kHz ±0.1%rdg±3dgt ACA 99.99/999.9Hz/9.999kHz ±0.1%rdg±3dgt
DUTY	1.0 - 99.9% ±1.0%rdg±3dgt [50/60Hz]
Applicable standards	IEC 61010-1 CAT IV 300V / CAT III 600V IEC 61010-2-033, IEC 61326-2-2
Power source	R03(1.5V) x 2
Dimensions	155(L) x 75(W) x 35(D) mm
Weight	250g approx. (including batteries)
Accessories	Wing-type holder, Flat-type holder, 7066A(Test leads) 8919(Ceramic fuse[10A/600V]) × 1(included), 9097(Carrying case), R03x2, Instruction manual
Optional Accessories	7234(Alligator clip), 8161(Clamp sensor) 8115(Clamp sensor), 9189(Magnet hanger strap)

- True-RMS Measurements
- Large display with backlight
- Sensor mode (with clamp sensor)
- MIN/MAX function
- Ergonomic design
- Compact body with over-mold
- Complies with IEC 61010-1

## Accessories



## Optional Accessories





# MULTIMETERS



## MODEL 1009

DC V AC V Ω Hz DUTY DATA HOLD REL AUTO POWER OFF

- Display : 4000 counts.
- Auto range and manual range selector provided. (with range hold feature)
- Resistance range provides audible continuity test.
- Automatically turns power off in about 30 minutes to conserve battery life.
- Direct current measurement up to 10A AC and DC.



## KEW 1011/1012

1012 TRUE RMS DC V AC V Ω Hz DUTY °C DATA HOLD MAX/MIN 1011 REL AUTO POWER OFF

- 6040 counts with Bar Graph display
- MIN/MAX function enables to record min & max value
- REL(relative value) function
- Temperature measurement, selectable for °C and °F (KEW 1011)
- True RMS can measure and indicate distorted waveforms (KEW 1012)
- DUTY function



photo : 1012

	1009	1011	1012
DC V	400mV/4/40/400/600V ±0.6%rdg±4dgt*	600.0mV/6.000/60.00/600.0/600V ±0.5%±2dgt*	
AC V	400mV/4/40/400/600V ±1.3%rdg±4dgt*	6.000/60.00/600.0/600V ±1.0%±3dgt*	6.000/60.00/600.0/600V ±1.2%±3dgt*
DC A	400/4000μA/40/400mA/4/10A ±1.0%rdg±4dgt*	600/6000μA/60/600mA/6/10A ±1.2%±3dgt*	
AC A	400/4000μA/40/400mA/4/10A ±2.0%rdg±4dgt*	600/6000μA/60/600mA/6/10A ±1.5%±4dgt*	
Ω	400Ω/4/40/400kΩ/4/40MΩ ±1.0%rdg±4dgt	600Ω/6/60/600kΩ/6/60MΩ ±1.0%±2dgt*	
Continuity buzzer	400Ω(Buzzer sounds below 70Ω)	0 - 600Ω(Buzzer sounds below 100Ω)	
Diode test	1.5V Release Voltage : Approx. 0.4mA test current	2.8V release voltage : Approx. 0.4mA test current	
Capacitance test	40/400nF/4/40/100μF	40/400nF/4/40/4000μF	
Frequency	5.12/51.2/512Hz/5.12/51.2/512kHz/5.12/10MHz	10/100/1000Hz/10/100/1000kHz/10MHz	
DUTY	0.1 - 99.9%(Pulse width/Pulse period) ±2.5%±5dgt	0.1 - 99.9%(Pulse width/Pulse period) ±2.0%±2dgt( - 10kHz)	
Temperature	—	-50 - 300°C(-58 - 572°F)(with the use of Temperature probe 8216)	—
Applicable standards	IEC 61010-1 CAT III 300V, IEC 61326-1	IEC 61010-1 CAT III 300V, CAT II 600V, IEC 61326	
Power source	R6(1.5V) × 2 (Auto power off : approx. 30 minutes)	R6(1.5V) × 2 (Auto power off : approx. 15 minutes)	
Dimensions	161(L) × 82(W) × 50(D)mm	161(L) × 82(W) × 50(D)mm	
Weight	280g approx.	280g approx.	
Accessories	7066A(Test leads), 8919(Ceramic fuse[10A/600V]) × 1, 8923(Ceramic fuse [0.5A/600V]) × 1, R6 × 2, Instruction manual	7066A(Test leads), 8216(K-type temperature probe)(1011 Only), 8918(Ceramic fuse[0.8A/600V]) × 1 built-in, 8919(Ceramic fuse[10A/600V]) × 1 built-in, R6 × 2, Instruction manual	
Optional	7234(Alligator clip), 9095(Carrying case)		

\*Basic accuracy : For the detailed accuracy, please see our product catalog on our website.



## KEW 1109S

DC V AC V Ω dB

- Mirrored scale for easy and accurate reading.
- Output terminal to cut off DC component when measuring AC voltage.
- Safety designed input terminals and test leads.

	1109S
DC V	0.1/0.5/2.5/10/50/250/1000V(20kΩ/V) ±3% of FS
AC V	10/50/250/1000V(9kΩ/V) ±3% of FS
DC A	50μA/2.5/25/250mA ±3% of FS
Ω	2/20kΩ/2/20MΩ ±3% of scale length
Decibel	-10 - +62dB
hFE	0 - 1000(Ω × 10) ±3% of scale length
Power source	R6(AA)(1.5V) × 2, 6F22(9V) × 1
Dimensions	150(L) × 100(W) × 47(D)mm
Weight	330g approx.
Accessories	7210A(Test leads), 8901(Fuse[0.5A/250V]) × 2, R6(AA) × 2, 6F22 × 1, Instruction manual
Optional	9168(Carrying case)



## MODEL 1110

DC V AC V Ω °C

- High sensitivity DC20kΩ/V.
- 1m drop-proof heavy duty designed taut-band movement.
- Can measure line voltage up to AC 600V. (Voltage to ground MAX AC 300V) (Protected by 600V ceramic fuse against accidental overload)
- Continuity buzzer, battery check, LED check, temperature measurement function.
- Skeleton type robust and clear case with carrying handle furnished as standard accessory.

	1110
DC V	0.3V(16.7kΩ/V) ±3% of FS 3/12/30/120/300/600V(20kΩ/V) ±3% of FS
AC V	12V(9kΩ/V) ±4% of FS 30/120/300/600V(9kΩ/V) ±3% of FS
DC A	60μA/30/300mA ±3% of FS
Ω	3/30/300kΩ ±3% of scale length
Continuity buzzer	Buzzer sounds below 100Ω
Battery Test	1.5V(0.7 - 2V) ±3% of FS (10Ω load)
Temperature	-20°C - +150°C ±3% of scale length(0°C - +100°C) ±4% of scale length(other ranges)(with the use of Temperature probe 7060)
LED	10mA approx. at 0Ω (at 3V of battery voltage)
Applicable standards	IEC 61010-1 CAT III 300V /CAT II 600V, IEC 61326-1
Power source	R6(AA)(1.5V) × 2
Dimensions	140(L) × 94(W) × 39(D)mm
Weight	280g approx.
Accessories	7066A(Test leads), 8923(Fuse[F500mA/600V]) × 2, R6(AA) × 2, 9103(Carrying case), Instruction manual
Optional	7060(Temperature probe)



# DIGITAL MULTIMETERS

DIGITAL MULTIMETERS

## KEW 1019R NEW

- TRUE RMS
DC AC V
Ω
•••••
↔
REL
AUTO POWER SAVE



- True-RMS Measurements.
- Large display.
- Sturdy measurement code.
- Simple range composition.
- Easy-to-use smart structure hard case.
- DCV, ACV, Ω capacitor Measurement.
- Complies with IEC 61010-1 CAT III 300V, CAT II 600V.

	1019R
DC V	600.0mV/6.000/60.00/600.0V(Input impedance :10MΩ) ±0.8%rdg±5dgt(600.0mV/6.000/60.00V) ±1.0%rdg±5dgt(600.0V)
AC V	6.000/60.00/600.0V(Input impedance:10MΩ) ±1.3%rdg±5dgt(6.000/60.00V)(50/60Hz) ±1.7%rdg±5dgt(6.000/60.00V)(45 - 500Hz) ±1.6%rdg±5dgt(600.0V)(50/60Hz) ±2.0%rdg±5dgt(600.0V)(45 - 500Hz)
Ω	600.0Ω/6.000/60.00/600.0kΩ/6.000/40.00MΩ ±1.0%rdg±5dgt(600.0Ω)/6.000/60.00/600.0kΩ/6.000MΩ) ±2.5%rdg±5dgt(40.00MΩ)
Continuity buzzer	600Ω(Buzzer sounds below 60Ω)
Capacitance test	6.000/60.00/600.0nF/6.000/60.00/600.0μF ±3.5%rdg±5dgt(6.000nF) ±3.5%rdg±10dgt(60.00nF) ±3.5%rdg±5dgt(600.0nF/6.000/60.00μF) ±4.5%rdg±5dgt(600.0μF)
Applicable standards	IEC 61010-1 CAT III 300V,CAT II 600V IEC 61010-2-033, IEC 61010-031, IEC 61326-2-2
Power source	CR2032(3V) × 1 (Auto power off : approx. 15 minutes)
Dimensions	126(L) × 85(W) × 18(D)mm (including hard case)
Weight	135g approx. (including battery and hard case)
Accessories	9188(Hard case), CR2032(3V) × 1, Instruction manual

Retractable Case Cover

2Way Test Probe Holder

Cap Holder

with Caps : CAT III  
without Caps : CAT II

## KEW 1018/1018H

- DC AC V
Ω
•••••
→
↔
Hz
DUTY
DATA HOLD
REL
AUTO POWER OFF



- Display : 4000 counts.
- Diode test feature.
- Continuity test.
- Auto range.
- Capacitance test feature.

	1018/1018H
DC V	400mV/4/40/400/600V(Input impedance 10MΩ) ±0.8%rdg±5dgt(400mV/4/40/400V) ±1.0%rdg±5dgt(600V)
AC V	4/40/400/600V(Input impedance 10MΩ) ±1.3%rdg±5dgt(4/40V) ±1.6%rdg±5dgt(400/600V)
Ω	400Ω/4/40/400kΩ/4/40MΩ ±1.0%rdg±5dgt(400Ω/4/40/400kΩ/4MΩ) ±2.5%rdg±5dgt(40MΩ)
Continuity buzzer	400Ω(Buzzer sounds below 120Ω)
Diode test	4V release voltage : Approx. 0.4mA test current
Capacitance test	4nF/40nF/400nF/4μF/40μF/200μF
Frequency	10/100Hz/1/10kHz (Input sensitivity Voltage:more than 1.5V)
Duty	0.1 - 99.9% ±2.5%rdg±5dgt(Pulse width/Pulse cycle)
Applicable standards	IEC 61010-1 CAT III 300V, IEC 61010-031, IEC 61326-1
Power source	LR44(1.5V) × 2 (Auto power off : approx. 15 minutes)
Dimensions	107(L) × 54(W) × 10(D)mm
Weight	70g approx.
Accessories	9115(Carrying case[Soft]), 9114(Carrying case[Hard]), LR44× 2, Instruction manual



## KEW 1030

- DC AC V
Ω
•••••
→
↔
Hz
  
DUTY
☀
DATA HOLD
REL
AUTO POWER OFF



- Compact in Size, Light in Weight and Simple in Use
- Double moulding provides comfortable and good feeling in hand
- Penlight illuminates brightly the point to be measured, even in dark place
- Backlight LCD is highly visible, even in darkness
- Unique wrapping mechanism for test lead in the rear side compartment

	1030
DC V	400mV/4/40/400/600V(5 range auto) ±0.8%rdg±5dgt(400mV - 400V) ±1.0%rdg±5dgt(600V)
AC V	4/40/400/600V(4 range auto) ±1.3%rdg±5dgt(4/40V)(50/60Hz) ±1.6%rdg±5dgt(400/600V) (50/60Hz)
Ω	400/4k/40k/400k/4M/40MΩ(6 range auto) ±1.0%rdg±5dgt(400Ω - 4MΩ) ±2.5%rdg±5dgt(40MΩ)
Continuity buzzer	Buzzer sounds when resistance is 120Ω or less.
Diode test	Test voltage approx. 0.3 - 1.5V
Capacitance test	50n/500n/5μ /50μ /100μF(5 range auto) ±3.5%rdg±10dgt(50nF) ±3.5%rdg±5dgt(500n - 50μF) ±4.5%rdg±5dgt(100μF)
Frequency	5/50/500/5k/50k/200kHz ±0.1%rdg±5dgt
Duty	0.1 - 99.9% ±2.5%rdg±5dgt (Pulse width / Pulse cycle)
Applicable standards	IEC 61010-1 CAT III 600V, IEC 61010-031, IEC 61326-1(EMC)
Power source	Button type battery LR44(SR44)(1.5V) × 2 (Auto power off : approx. 30 minutes)
Dimensions	190(L) × 39(W) × 31(D)mm
Weight	Approx. 100g (including batteries)
Accessories	9130(Carrying case), LR44(1.5V) × 2, Instruction manual



# DIGITAL MULTIMETERS

## KEWMATE 2012R



TRUE RMS  $\emptyset$ 12 MAX 120A DC AC V DC AC A  $\Omega$   $\rightarrow$   $\leftarrow$  Hz DATA HOLD AUTO POWER SAVE

- Innovative Multimeters with current measurements up to 120A AC/DC
- Unique Open Jaw technology for AC/DC current measurements
- Very compact and as reliable as a traditional full size multimeter

	2012R
DC V	600.0mV/6.000/60.00/600.0V (Input impedance: approx. 10M $\Omega$ ) $\pm$ 1.0%rdg $\pm$ 3dgt
AC V	6.000/60.00/600.0V (Input impedance: approx.10M $\Omega$ ) $\pm$ 1.5%rdg $\pm$ 5dgt (45 - 400Hz)
DC A	60.00/120.0A $\pm$ 2.0%rdg $\pm$ 8dgt (60A) $\pm$ 2.0%rdg $\pm$ 5dgt (120A)
AC A	60.00/120.0A $\pm$ 2.0%rdg $\pm$ 5dgt (45 - 65Hz)
$\Omega$	600.0 $\Omega$ /6.000/60.00/600.0k $\Omega$ /6.000/60.00M $\Omega$ $\pm$ 1.0%rdg $\pm$ 5dgt (600 $\Omega$ /6/60/600k $\Omega$ ) $\pm$ 2.0%rdg $\pm$ 5dgt (6M $\Omega$ ) $\pm$ 3.0%rdg $\pm$ 5dgt (60M $\Omega$ )
Continuity buzzer	Buzzer sounds below 35 $\pm$ 25 $\Omega$
Diode test	2V $\pm$ 3.0%rdg $\pm$ 5dgt Open-loop voltage: approx. 2.7V
Capacitance	400.0nF/4.000/40.00 $\mu$ F $\pm$ 2.5%rdg $\pm$ 10dgt
Frequency	AC A: 100/400Hz $\pm$ 0.2%rdg $\pm$ 2dgt (100Hz) $\pm$ 0.1%rdg $\pm$ 1dgt (100 - 400Hz) AC V: 100/1000Hz/10/100/300.0kHz $\pm$ 0.2%rdg $\pm$ 2dgt (100Hz) $\pm$ 0.1%rdg $\pm$ 1dgt (1000Hz/10/100/300.0kHz) (Input sensitivity Current: more than 6A Voltage: more than 6V [ - 10kHz]/more than 20V [10k - 300kHz])
Conductor size	$\phi$ 12mm max.
Applicable Standards	IEC 61010-1 CAT III 300V, CAT II 600V Pollution degree 2 IEC 61010-031, IEC 61010-2-032, IEC 61326
Power source	R03 (1.5V) $\times$ 2 *Continuous measuring time:DCV: approx. 150hours, ACA: approx. 25hours(Auto power save: approx. 15 minutes)
Dimensions	128 (L) $\times$ 92 (W) $\times$ 27 (D) mm
Weight	220g approx. (including batteries)
Accessories	R03 (1.5V) $\times$ 2, Instruction manual
Optional	9107 (Carrying case [Soft])

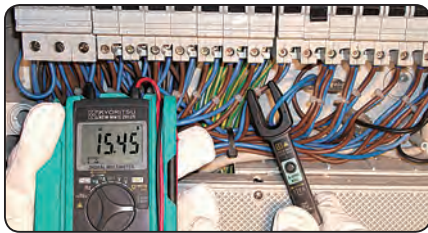

Measuring current in a Switchboard



Forklift maintenance

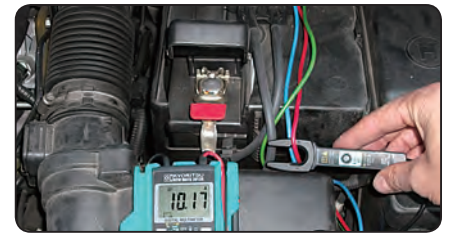

Automobile maintenance

## MODEL 2000 $\emptyset$ 6 MAX 60A / 2001 $\emptyset$ 10 MAX 100A

### KEWMATE

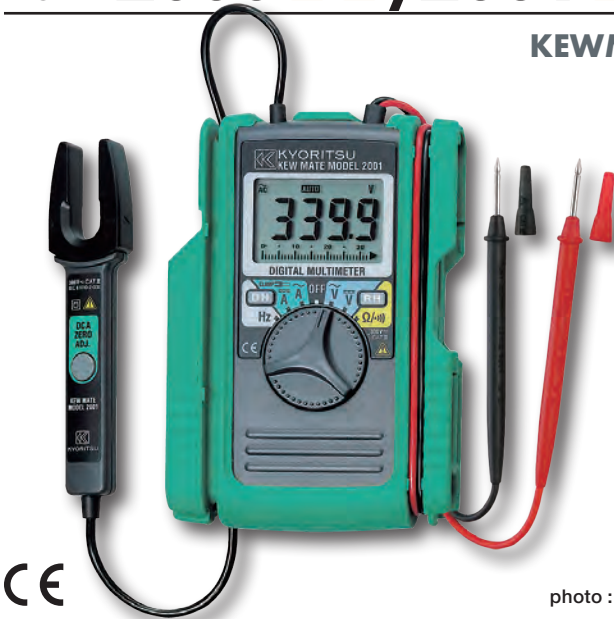

photo : 2001

DC AC V DC AC A  $\Omega$   $\rightarrow$   $\leftarrow$  Hz DATA HOLD AUTO POWER SAVE

- Capable of measuring AC and DC currents up to 60A(MODEL 2000) /100A (MODEL 2001) with OPEN CLAMP SENSOR.
- 3400 counts with bargraph display.
- Pocket size and heavy duty design.
- Sleep function to save battery consumption.
- Designed to international safety standard IEC 61010-1 CAT III 300V

	2000	2001
DC V	340mV/3.4/34/340/600V (Input impedance : 10M $\Omega$ ) $\pm$ 1.5%rdg $\pm$ 4dgt	
AC V	3.4/34/340/600V (Input impedance : 10M $\Omega$ ) $\pm$ 1.5%rdg $\pm$ 5dgt[50 - 400Hz]	
DC A	60A $\pm$ 2%rdg $\pm$ 5dgt	100A $\pm$ 2%rdg $\pm$ 5dgt
AC A	60A $\pm$ 2%rdg $\pm$ 5dgt(50/60Hz)	100A $\pm$ 2%rdg $\pm$ 5dgt(50/60Hz)
$\Omega$	340 $\Omega$ /3.4/34/340k $\Omega$ /3.4/34M $\Omega$ $\pm$ 1%rdg $\pm$ 3dgt(0 - 340k $\Omega$ ) $\pm$ 5%rdg $\pm$ 5dgt(3.4M $\Omega$ ) $\pm$ 15%rdg $\pm$ 5dgt (34M $\Omega$ )	
Continuity buzzer	Buzzer sounds below 30 $\pm$ 10 $\Omega$ (Continuity buzzer works on 340 $\Omega$ range only)	
Frequency	(AC A)3.4/10kHz $\pm$ 0.1%rdg $\pm$ 1dgt (AC V)3.4/34/300kHz $\pm$ 0.1%rdg $\pm$ 1dgt  (Input sensitivity Current:more than 15A Voltage:more than 30V)	(Input sensitivity Current:more than 25A Voltage:more than 30V)
Conductor size	$\phi$ 6mm max.	$\phi$ 10mm max.
Applicable standards	IEC 61010-1 CAT III 300V Pollution degree 2 IEC 61010-031, IEC 61010-2-032, IEC 61326-1	
Power source	R03(DC1.5V) $\times$ 2 *Continuous measuring time : approx. 45 hours (Auto power save : approx. 10 minutes)	
Dimensions	128(L) $\times$ 87(W) $\times$ 24(D)mm	128(L) $\times$ 92(W) $\times$ 27(D)mm
Weight	210g approx.	220g approx.
Accessories	R03(1.5V) $\times$ 2 Instruction manual	
Optional	9107(Carrying case[Soft])	

# DIGITAL MULTIMETERS

DIGITAL MULTIMETERS



photo : 1052

photo : 1062

## KEW 1051/1052 KEW 1061/1062

TRUE RMS CAT IV 600V DC AC V DC AC A 1061,1062 1062 Ω LP-Ω 1062 Except for 1051 Hz DUTY °C dB DATA HOLD PEAK HOLD MAX/MIN AVG REL Filter  
1061,1062 1061,1062 1062 Except for 1051  
Except for 1051 AUTO POWER OFF

- True-RMS or MEAN value detection mode can be selected \*only for 1052, 1062
- DC+AC TRMS Measurement \*only for 1061, 1062  
AC and DC values are displayed simultaneously via dual display.
- Fast Peak Hold response time of 250µs \*only for 1062
- Low-pass filter \*except for 1061
- Low Power-Ω measurements \*only for 1062
- User calibration function

### Safety design for industrial use

- Complies with IEC 61010-1 CAT III 1000V, CAT IV 600V
- Terminal shutter to prevent incorrect test leads' insertion in current terminals
- Very wide operating temperature range  
From -20 to +55°C for 1061/1062  
From -10 to +55°C for 1051/1052

### Reliable support for data management

#### \*except for 1051

- Large data internal memory
- Download data and Live Monitoring on a PC via the USB interface (Option for USB Communication set)

### High Accuracy, High Performance and Reliable Measurements

- Top accuracy  
0.02% basic DC accuracy for 1061/1062.  
0.09% basic DC accuracy for 1051/1052.
- Dual display  
1061/1062: 50,000 counts, Bar graph with 51 segments. White back light display.  
1051/1052: 6,000 counts, Bar graph with 31 segments. Orange back light display.
- True-RMS Measurements
- Wide AC Frequency bandwidth from 10Hz to 100kHz \*only for 1062

	1051	1052	1061	1062
Detection mode	RMS	MEAN/RMS (switch)	RMS	MEAN/RMS (switch)
DC V	600.0mV/6.000/60.00/600.0/1000V (Input impedance: 10MΩ [600mV/60/600/1000V], 11MΩ [6V]) ±0.09%rdg±2dgt *		50.000/500.00/2400.0mV/5.0000/50.000/500.00/1000.0V (Input impedance: Approx. 100MΩ [50/500/2400mV], 10MΩ [5/50/500/1000V]) ±0.02%rdg±2dgt *	
AC V [RMS]	600.0mV/6.000/60.00/600.0/1000V (Input impedance: 10MΩ<200pF [600mV], 11MΩ<50pF [6V], 10MΩ<50pF [60/600/1000V]) ±0.5%rdg±5dgt *		50.000*/500.00mV/5.0000/50.000/500.00/1000.0V (Input impedance: 11MΩ<50pF [50/500mV/5V], 10MΩ<50pF [50/500/1000V]) ±0.7%rdg±30dgt *	** 1062only ±0.4%rdg±30dgt *
AC V [MEAN]	-	-	-	50.000/500.00mV/5.0000/50.000/500.00/1000.0V (Input impedance: 11MΩ<50pF [50/500mV/5V], 10MΩ<50pF [50/500/1000V]) ±1%rdg±30dgt *
DCV+ACV	-	-	5.0000/50.000/500.00/1000.0V (Input impedance: 11MΩ<50pF [5V], 10MΩ<50pF [50/500/1000V]) ±1%rdg±10dgt *	±0.5%rdg±10dgt *
DC A	600.0/6000µA/60.00/440.0mA/6.000/10.00A ±0.2%rdg±2dgt *		500.00/5000.0µA/50.000/500.00mA/5.0000/10.000A ±0.2%rdg±5dgt *	
AC A [RMS]	600.0/6000µA/60.00/440.0mA/6.000/10.00A ±0.75%rdg±5dgt *		500.00/5000.0µA/50.000/500.00mA/5.0000/10.000A ±1%rdg±20dgt *	±0.75%rdg±20dgt *
AC A [MEAN]	-	-	-	500.00/5000.0µA/50.000/500.00mA/5.0000/10.000A ±1.5%rdg±20dgt *
DCA+ACA	-	-	500.00/5000.0µA/50.000/500.00mA/5.0000/10.000A ±1.5%rdg±10dgt *	±1%rdg±10dgt *
Ω	600.0Ω/6.000/60.00/600.0kΩ/6.000/60.00MΩ ±0.4%rdg±1dgt *		500.00Ω/5.0000/50.000/500.00kΩ/5.0000/50.000MΩ ±0.1%rdg±2dgt *	±0.05%rdg±2dgt *
LowPower-Ω	-	-	-	5.000/50.00/500.0kΩ/5.000MΩ ±0.2%rdg±3dgt *
Continuity buzzer	600.0Ω (The buzzer turns on for resistances lower than 50±30Ω)		500.0Ω (The buzzer turns on for resistances lower than 100±50Ω)	
Diode test	2.000V ±1%rdg±2dgt Open circuit voltage: <3.5V (Approx. 0.5mA Measuring Current)		2.4000V ±1%rdg±2dgt Open circuit voltage: <5V (Approx. 0.5mA Measuring Current)	
Capacitance	10.00/100.0nF/1.000/10.00/100.0/1000µF ±2%rdg±5dgt *		5.000/50.00/500.0nF/5.000/50.00/500.0µF/5.000/50.00mF ±1%rdg±5dgt *	
Frequency	10.00 - 99.99/90.0 - 999.9Hz/0.900 - 9.999/9.00 - 99.99kHz ±0.02%rdg±1dgt *		2.000 - 9.999/9.00 - 99.99/90.0 - 999.9Hz/0.900 - 9.999/9.00 - 99.99kHz ±0.02%rdg±1dgt *	
DUTY	-	-	10 - 90% ±1%rdg	
Temperature	-50 - 600°C ±2%rdg±2°C (with the use of K-type Temperature probe)		-200 - 1372°C ±1%rdg±1.5°C (with the use of K-type Temperature probe)	
Application standards	IEC 61010-1 CAT IV 600V, CAT III 1000V Pollution degree 2, IEC 61326-1 (EMC)			
Power source	R6 (1.5V)×4 (Auto power off: approx. 20 minutes)			
Dimensions	192(L)×90(W)×49(D) mm			
Weight	Approx. 560g (including batteries)			
Accessories	7220A (Test Leads), R6×4, 8926 (Fuse [440mA/1000V])×1 (included), 8927 (Fuse [10A/1000V])×1 (included) Instruction manual			

\*Basic accuracy : For the detailed accuracy, please see our product catalog on our website.



# DIGITAL MULTIMETERS

## Reliable support for data management

※ except for 1051

### Large internal memory to store test data

- KEW1062: 10,000 data in Logging mode, 100 data manually saved.
- KEW1061: 1,000 data in Logging mode, 100 data manually saved.
- KEW1052: 1,600 data in Logging mode, 100 data manually saved.
- Logging interval can set from 1 sec. to 30 min.

### Test data can be transferred to a PC or directly to a Printer\*

- Real-time data can be transferred and shown on a PC.
- Real-time transferring permits the saving of a considerable amount of data on a PC.
- Stored data of internal memory can be monitored by PC.

### Data management with the software DMM Application\*

- Stored data of internal memory can be monitored by PC.
- List of measured data can be converted into Graph.
- Data can be transferred to Excel\*\* and saved as CSV file.

\*Optional accessories are required.

\*\*Excel is a registered trademark of Microsoft in the USA.

#### Data analysis with Excel

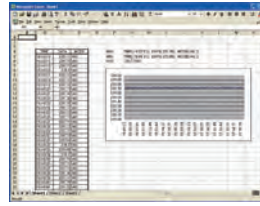

#### Printer output

L0000 N+12.539 VDC  
L0001 N+12.532 VDC  
L0002 N+12.532 VDC  
L0003 N+12.529 VDC  
L0004 N+12.532 VDC  
L0005 N+12.538 VDC  
L0006 N+12.541 VDC  
L0007 N+12.546 VDC  
L0008 N+12.552 VDC  
L0009 N+12.557 VDC  
L0010 N+12.555 VDC  
L0011 N+12.554 VDC  
L0012 N+12.553 VDC  
L0013 N+12.553 VDC

Printed items (from the left)  
- L: Logging memory  
- 4 digit numbers: Data number  
- N: Normal measurement  
(O: at "OL" display)  
(B: at "Battery warning" display)  
- 5 digit numbers: Measurement  
- VDC: Unit (VDC is DC Voltage)



#### DMM Application software

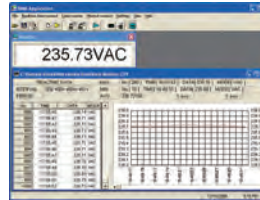

#### System requirements

OS: Windows® Vista/7(32/64bit)/8(32/64bit)  
Display: XGA (Resolution 1024 x 768 dots) or more  
Hard-disk: Space required 10Mbyte or more  
Others: With CD-ROM drive and USB port

\* Windows® is a registered trademark of Microsoft in the United States.

## Optinal Accessories

Description	MODEL	Contents
Alligator Clip	7234	CAT IV 600V, CAT III 1000V 1set
USB Communication set	8241	USB adaptor+USB cable+DMM Software
DMM Printer full set	8249	8243+8246+8248
Printer Communication set	8243	Printer Adapter+RS232 cable
Printer	8246	Printer (paper width 112mm)+paper×1 roll
AC adapter for printer [EU]	8248	AC230V±10%
Thermal paper for printer	8247	10 rolls
Thermocouple Type K	8405	Max. 500°C (Surface type, Point material: Ceramic)
	8406	Max. 500°C (Surface type)
	8407	Max. 700°C (Liquid, Semi-solid)
	8408	Max. 600°C (Air, Gas)
Clamp sensor	8115	Surface type
	8121	AC 100A
	8122	AC 500A
	8123	AC 1000A
	8146	AC 30A
	8147	AC 70A
	8148	AC 100A
Banana φ4mm Adjuster Plug	7146	length :190mm
Carrying case	9154	Soft case (for the main unit with test leads and communication cable)

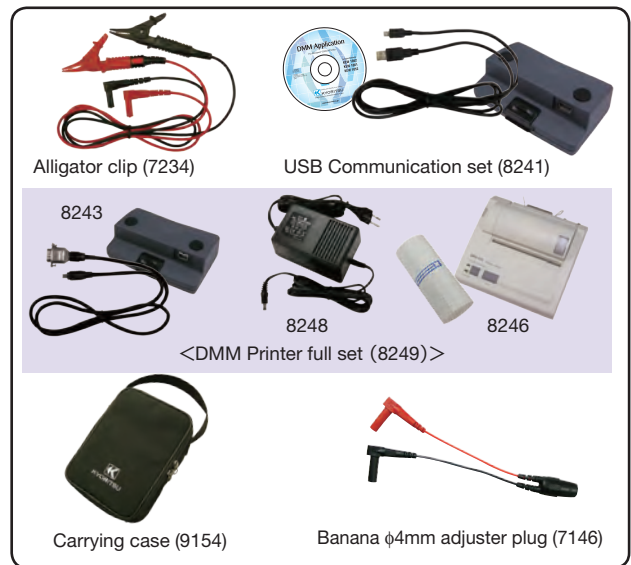

## Thermocouple Type K Specification

MODEL	Usage	Measurement temperature	Tolerance (t: measurement temperature)	Response speed
8405	(Surface type, Point material: Ceramic)	Max. 500°C	±2.5°C/t=-40°C - 333°C, ±0.0075× t °C/t =333°C - 500°C	approx. 1.8 Sec.
8406	Surface type			
8407	(Liquid, Semi-solid)	Max. 700°C	±2.5°C/t=-40°C - 333°C, ±0.0075× t °C/t =333°C - 700°C	1 Sec. or less
8408	(Air, Gas)	Max. 600°C	±2.5°C/t=-40°C - 333°C, ±0.0075× t °C/t =333°C - 600°C	0.4 Sec.

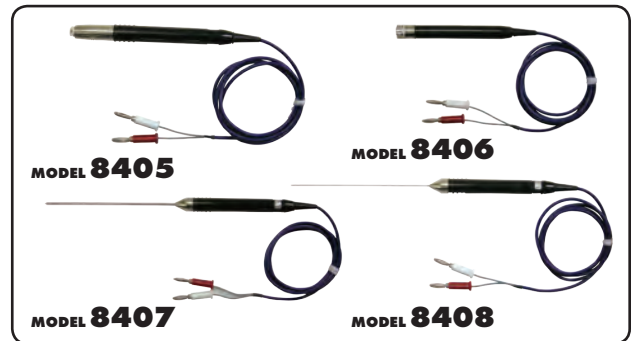

## Clamp sensor Specification

	AC/DC current sensor	AC current sensor				Leakage & AC current sensor		
	8115	8121	8122	8123	8146	8147	8148	
Appearance								
Conductor size	φ12	φ24	φ40	φ55	φ24	φ40	φ68	
Rated current	Surface type	AC 100A	AC 500A	AC 1000A	AC 30A	AC 70A	AC 100A	
Output voltage	(Liquid, Semi-solid)	AC 500mV/100A	AC 500mV/500A	AC 500mV/1000A	AC 1500mV/30A	AC 3500mV/70A	AC 5000mV/100A	
Accuracy (50/60Hz)	AC ±1.0%rdg±0.4mV DC ±1.0%rdg±0.4mV (This accuracy is defined after a zero-adjustment)	±2.0%rdg±0.3mV			0 - 15A ±1.0%rdg±0.1mV 15 - 30A ±5.0%rdg	0 - 40A ±1.0%rdg±0.1mV 40 - 70A ±5.0%rdg	0 - 80A ±1.0%rdg±0.1mV 80 - 100A ±5.0%rdg	
Frequency range	40Hz - 1kHz							
Dimensions	127(L)×42(W)×22(D)mm	97(L)×59(W)×26(D)mm	128(L)×81(W)×36(D)mm	170(L)×105(W)×48(D)mm	100(L)×60(W)×26(D)mm	128(L)×81(W)×36(D)mm	186(L)×129(W)×53(D)mm	
Weight	approx. 160g	approx. 150g	approx. 260g	approx. 360g	approx. 150g	approx. 240g	approx. 510g	

# CLAMP METERS

CLAMP METERS





# CLAMP METERS

Selection Guide of Clamp Meters

		AC Clamp Meters											Fork Current Tester	DC Milliamp Clamp Meter
		2608A	2031	2007A	2017	2027	2040	2200	2200R	2002PA	2002R	2210R	2300R	2500
Appearance														
Conductor size		φ33mm	φ24mm	φ33mm	φ33mm	φ33mm	φ33mm	φ33mm	φ33mm	φ55mm	φ55mm	φ150mm	φ10mm	φ6 mm
Display		Analogue	Digital	Digital	Digital	Digital	Digital	Digital	Digital	Digital	Digital	Digital	Digital	Digital
Detection method		-	-	-	-	✓	-	-	✓	-	✓	✓	✓	-
Frequency response		50/60Hz	40 - 1kHz	40 - 400Hz	45 - 1kHz	40 - 1kHz	40 - 400Hz	45 - 65Hz(ACA) 45 - 500Hz(ACV)	40 - 1kHz(ACA) 45 - 500Hz(ACV)	40 - 1kHz	40 - 1kHz	45 - 500Hz	DC 50/60Hz	DC
<b>Measurement</b>														
AC A	Max	300A	200A	600A	600A	600A	600A	1000A	1000A	2000A	2000A	3000A	100A	-
	Resolution	0.2A	0.01A	0.1A	0.1A	0.1A	0.1A	0.01A	0.01A	0.1A	0.1A	0.01	0.1A	-
	Accuracy	±3% of FS	±2%R±5D	±1.5%R±4D	±1.5%R±4D	±1.5%R±4D	±1.5%R±5D	±1.4%R±6D	±1.5%R±5D	±1%R±3D	±1.5%R±3D	±3%R±5D	±2%R±5D	-
DC A	Max	-	-	-	-	-	-	-	-	-	-	-	100A	120mA
	Resolution	-	-	-	-	-	-	-	-	-	-	-	0.1A	0.01mA
	Accuracy	-	-	-	-	-	-	-	-	-	-	-	±2%R±5D	±0.2%R±5D
AC Voltage		600V	-	750V	600V	600V	600V	600V	600V	750V	750V	-	-	-
DC Voltage		60V	-	-	-	-	600V	600V	600V	1000V	1000V	-	-	-
Resistance		10KΩ	-	4000Ω	200Ω	200Ω	60MΩ	40MΩ	40MΩ	400KΩ	400KΩ	-	-	-
Continuity buzzer		-	-	✓	✓	✓	✓	✓	✓	✓	✓	-	-	-
Frequency		-	-	-	-	-	10kHz	-	-	-	-	-	-	-
Duty cycle ratio		-	-	-	-	-	✓	-	-	-	-	-	-	-
Diode test		-	-	-	-	-	✓	-	-	-	-	-	-	-
Capacitance		-	-	-	-	-	-	-	-	-	-	-	-	-
Temperature		✓	-	-	-	-	-	-	-	-	-	-	-	-
<b>Function</b>														
Non contact voltage		-	-	-	-	-	✓	-	-	-	-	-	✓	-
Back light		-	-	-	-	-	-	-	-	-	-	✓	-	✓
Data hold		✓	✓	✓	✓	✓	✓	✓	✓	✓	✓	✓	✓	✓
Peak hold		-	-	-	-	-	-	-	-	✓	✓	-	-	-
Max/Min		-	-	-	-	-	✓	-	-	-	-	✓	-	-
Relative		-	-	-	-	-	✓	-	-	-	-	-	-	-
Output		-	-	-	-	-	-	-	-	✓	✓	-	-	✓
<b>Other</b>														
Operating temperature		0 - 40°C	0 - 40°C	0 - 40°C	-10 - 50°C	-10 - 50°C	0 - 40°C	0 - 40°C	0 - 40°C	0 - 40°C	0 - 40°C	0 - 50°C	0 - 40°C	-10 - 50°C
Measurement categories		CAT III 300V CAT II 600V	CAT III 300V	CAT III 300V	CAT III 600V	CAT III 600V	CAT IV 600V	CAT III 600V(ACA) CAT III 300V(AC/DCV) CAT II 600V(AC/DCV)	CAT IV 300V(ACA) CAT III 600V(ACA) CAT III 300V(AC/DCV) CAT II 600V(AC/DCV)	CAT III 600V CAT II 1000V	CAT III 600V CAT II 1000V	CAT IV 600V CAT III 1000V	CAT III 300V	CAT II 300V
Power source		R6 x 1	LR-44 x 2	R03 x 2	6F22 x 1	6F22 x 1	R03 x 2	R03/LR03 x 2	R03/LR03 x 2	R6 x 2	R6 x 2	R03/LR03 x 2	R03 x 2	LR6 x 4
Dimensions (L)x(W)x(D)mm		193x78x39	147x58.5x26	195x78x36	208x91x40	208x91x40	243x77x36	190x68x20	190x68x20	247x105x49	247x105x49	120x70x26	161x40x30	111x61x40 (Display unit) 104x34x20 (Sensor)
Weight(Approx.)		275g	100g	260g	400g	400g	300g	120g	120g	470g	470g	300g	110g	290g
Accessories	Test leads	7066A	-	7066A	7066A	7066A	7066A	7107A	7107A	7107A	7107A	-	-	-
	Fuse	8923x2	-	-	-	-	-	-	-	-	-	-	-	-
	Case	9097	9090	9097	9079	9079	9094	9160	9160	9094	9094	9174	9113	9096



# CLAMP METERS

Selection Guide of Clamp Meters

		AC/DC Clamp Meters						Leakage Clamp Meters					
		2010	2033	2046R	2055 2056R	2003A	2009R	2431	2434	2432	2433 2433R	2412	2413F 2413R
Appearance													
Conductor size	$\Phi$	$\phi 7.5\text{mm}$	$\phi 24\text{mm}$	$\phi 33\text{mm}$	$\phi 40\text{mm}$	$\phi 55\text{mm}$	$\phi 55\text{mm}$	$\phi 24\text{mm}$	$\phi 28\text{mm}$	$\phi 40\text{mm}$	$\phi 40\text{mm}$	$\phi 40\text{mm}$	$\phi 68\text{mm}$
Detection method		-	-	✓	✓ (2056R)	-	✓	-	-	-	✓ (2433R)	-	✓ (2413R)
Frequency response		DC 40 - 2kHz	DC 20 - 1kHz	DC 40 - 400Hz	DC 40 - 400Hz	DC 40 - 1kHz	DC 20 - 1kHz	40 - 400Hz	40 - 400Hz	20 - 1kHz	20 - 1kHz	40 - 400Hz	40 - 1kHz
<b>Measurement</b>													
AC A	Max	20A	300A	600A	1000A	2000A	2000A	200A	100A	100A	400A	500A	1000A
	Resolution	0.1mA	0.01A	0.1A	0.1A	0.1A	0.1A	0.01mA	0.1mA	0.001mA	0.01mA	0.01mA	0.1mA
	Accuracy	$\pm 1\%R \pm 2D$	$\pm 1\%R \pm 4D$	$\pm 2\%R \pm 5D$	$\pm 2\%R \pm 5D$	$\pm 1.5\%R \pm 2D$	$\pm 1.3\%R \pm 3D$	$\pm 2\%R \pm 4D$	$\pm 2\%R \pm 4D$	$\pm 1\%R \pm 5D$	$\pm 1\%R \pm 5D$	$\pm 1\%R \pm 3D$	$\pm 1\%R \pm 2D$ (2413R) $\pm 1.8\%R \pm 5D$ (2413F)
DC A	Max	20A	300A	600A	1000A	2000A	2000A	-	-	-	-	-	-
	Resolution	0.001A	0.01A	0.1A	0.1A	0.1A	0.1A	-	-	-	-	-	-
	Accuracy	$\pm 1\%R \pm 2D$	$\pm 1\%R \pm 4D$	$\pm 1.5\%R \pm 5D$	$\pm 1.5\%R \pm 5D$	$\pm 1.5\%R \pm 2D$	$\pm 1.3\%R \pm 2D$	-	-	-	-	-	-
AC Voltage	$\text{AC V}$	-	-	600V	600V	750V	750V	-	-	-	-	600V	-
DC Voltage	$\text{DC V}$	-	-	600V	600V	1000V	1000V	-	-	-	-	-	-
Resistance	$\Omega$	-	-	60M $\Omega$	60M $\Omega$	4000 $\Omega$	4000 $\Omega$	-	-	-	-	200 $\Omega$	-
Continuity buzzer		-	-	✓	✓	✓	✓	-	-	-	-	-	-
Frequency	Hz	-	-	10kHz	10kHz	-	10kHz	-	-	-	-	-	-
Duty cycle ratio	DUTY	-	-	✓	✓	-	-	-	-	-	-	-	-
Diode test		-	-	✓	✓	-	-	-	-	-	-	-	-
Capacitance		-	-	✓	✓	-	-	-	-	-	-	-	-
Temperature	$^{\circ}\text{C}$	-	-	✓	✓ (2056R)	-	-	-	-	-	-	-	-
<b>Function</b>													
Non contact voltage	NCV	-	-	✓	✓	-	-	-	-	-	-	-	-
Back light		-	-	✓	✓	-	-	-	-	-	-	-	✓ (2413R)
Data hold	DATA HOLD	-	✓	✓	✓	✓	✓	✓	✓	✓	✓	✓	✓
Peak hold	PEAK HOLD	-	-	✓	✓ (2056R)	✓ (Max)	✓*	-	-	✓	✓	-	✓
Max/Min	MAX/MIN	-	-	✓	✓	-	-	-	-	-	-	-	-
Relative	REL	-	-	✓	✓	-	-	-	-	-	-	-	-
Output	OUT PUT	✓	-	-	-	✓	✓	-	-	-	-	✓	✓
Filter	Filter	-	-	-	-	-	-	✓	✓	✓	✓	✓	✓
<b>Other</b>													
Operating temperature		0 - 50 $^{\circ}\text{C}$	0 - 40 $^{\circ}\text{C}$	0 - 40 $^{\circ}\text{C}$	0 - 40 $^{\circ}\text{C}$	0 - 40 $^{\circ}\text{C}$	0 - 40 $^{\circ}\text{C}$	0 - 40 $^{\circ}\text{C}$	0 - 40 $^{\circ}\text{C}$	0 - 40 $^{\circ}\text{C}$	0 - 40 $^{\circ}\text{C}$	0 - 40 $^{\circ}\text{C}$	0 - 40 $^{\circ}\text{C}$
Measurement Categories		-	CAT III 300V	CAT IV 600V	CAT IV 600V	CAT IV 600V CAT III 1000V	CAT IV 600V CAT III 1000V	CAT III 300V	CAT III 300V	CAT III 300V	CAT III 300V	-	CAT III 300V
Power source		6LR61 x 1	LR-44 x 2	R03 x 2	R03 x 2	R6 x 2	R6 x 2	LR-44 x 2	R03 x 2	R03 x 2	R03 x 2	6F22 x 1	6F22 x 1
Dimensions (L)x(W)x(D)mm		142x64x26 (Display unit) 153x23x18 (Sensor)	147x59x25	243x77x36	254x82x36	250x105x49	250x105x49	149x60x26	169x75x40	185x81x32	185x81x32	209x96x45	250x130x50
Weight(Approx.)		220g	100g	300g	310g	530g	540g	120g	220g	290g	270g	450g	570g
Accessories	Test leads	-	-	7066A	7066A	7107A	7107A	-	-	-	-	7066A	-
	Case	9071	9090	9094	9094	9094	9094	9090	9097	9097	9097	9072	9094

\* In the PEAK mode, the auto-ranging feature is disabled and measuring ranges are fixed as follows.

DC/ACA : 0 - 400.0A  
DC/ACV : 0 - 400.0V

# ANALOGUE/DIGITAL CLAMP METERS

## MODEL 2608A

Ø33 MAX 300A °C AC A DC AC V Ω

DATA HOLD

- DC voltage range is also available especially for checking emergency battery operated power supply.
- Can measure temperature using optional probe.
- Tear drop shaped transformer jaws for ease of use.



CE

	2608A
AC A	6/15/60/150/300A ±3% of FS
AC V	150/300/600V ±3% of FS
DC V	60V ±3% of FS
Ω	1/10kΩ(25/250Ω mid-scale) ±2% of scale length
Temperature	-20°C - +150°C(with the use of Temperature probe 7060) ±5°C(0°C - +100°C) ±10°C(other ranges)
Conductor size	φ33mm max.
Frequency response	50/60Hz
Applicable standards	IEC 61010-1 CAT III 300V Pollution degree 2 IEC 61010-031 IEC 61010-2-032
Power source	R6(AA)(1.5V) × 1
Dimensions	193(L) × 78(W) × 39(D)mm
Weight	275g approx.
Accessories	7066A(Test leads) 8923(Fuse [0.5A/600V]) × 2 9097(Carrying case) R6(AA) × 1 Instruction manual
Optional	7060(Temperature probe) 8008(Multi-tran)

## MODEL 2007A

Ø33 MAX 600A AC A AC V Ω

- Sleep function to save battery.
- Data hold function.
- Digital display with maximum 4000 counts.



CE

	2007A
AC A	400/600A ±1.5%rdg±4dgt[50/60Hz] ±2%rdg±5dgt[40 - 400Hz]
AC V	400/750V ±1.2%rdg±3dgt[50/60Hz] ±1.5%rdg±4dgt[40 - 400Hz]
Ω	400/4000Ω ±1.5%rdg±2dgt
Continuity buzzer	buzzer sounds below 50±35Ω
Conductor size	φ33mm max.
Frequency response	40Hz - 400Hz
Applicable standards	IEC 61010-1 CAT III 300V IEC 61010-031 IEC 61010-2-032 IEC 61326(EMC)
Power source	R03(AAA)(1.5V) × 2 *Continuous measuring time : approx. 200 hours (Auto sleep function : approx. 10 minutes)
Dimensions	195(L) × 78(W) × 36(D)mm
Weight	260g approx.
Accessories	7066A(Test leads) 9097(Carrying case) R03(1.5V) × 2 Instruction manual
Optional	8008(Multi-tran)

## MODEL 2002PA/2002R

2002R TRUE RMS Ø55 MAX 2000A AC A DC AC V Ω

10ms DATA HOLD PEAK HOLD OUT PUT AUTO POWER SAVE

- Can measure large AC current up to 2000A.
- Peak hold function.
- 55mm-dia large tear drop shaped jaws.



CE

photo : 2002R

	2002PA	2002R
AC A	400A(0 - 400A) ±1%rdg±3dgt[50/60Hz] ±2%rdg±3dgt[40Hz - 1kHz] 2000A(0 - 1500A) ±1%rdg±3dgt[50/60Hz] ±3%rdg±3dgt[40Hz - 1kHz] 2000A(1500 - 2000A) ±3.0%rdg[50/60Hz]	400A(0 - 400A) ±1.5%rdg±3dgt[45 - 65Hz] ±2.5%rdg±3dgt[40Hz - 1kHz] 2000A(0 - 1500A) ±2%rdg±5dgt[45 - 65Hz] ±3%rdg±5dgt[40Hz - 1kHz] 2000A(1501 - 2000A) ±4%rdg[50/60Hz]
AC V	40/400/750V ±1%rdg±2dgt[50/60Hz] ±1.5%rdg±3dgt[40Hz - 1kHz]	40/400/750V ±1%rdg±2dgt[45 - 65Hz] ±1.5%rdg±3dgt[40Hz - 1kHz]
DC V	40/400/1000V ±1%rdg±2dgt	
Continuity buzzer	buzzer sounds below 50±35Ω	
Ω	400Ω/4k/40k/400kΩ ±1.5%rdg±2dgt	
Conductor size	φ55mm max.	
Frequency response	40Hz - 1kHz	
Output	Recorder:DC400mV against AC400A DC200mV against AC2000A	
Applicable standards	IEC 61010-1 CAT III 600V, CAT II 1000V IEC 61010-031 IEC 61010-2-032 IEC 61326-1	
Power source	R6(AA)(1.5V) × 2 *Continuous measuring time : approx. 150 hours (2002PA) *Continuous measuring time : approx. 80 hours (2002R) (Auto power save : approx. 10 minutes)	
Dimensions	247(L) × 105(W) × 49(D)mm	
Weight	470g approx.	
Accessories	7107A(Test leads) 8201(Output plug) 9094(Carrying case) R6(AA) × 2 Instruction manual	
Optional	7256(Output cord) 8008(Multi-tran)	

# DIGITAL CLAMP METERS AC



CE

## MODEL 2017

Ø33 MAX 600A AC A AC V Ω

DATA HOLD

- Tear drop shaped jaws for ease of use in tight places and crowded cable areas.
- Three functions in one unit; AC current, AC voltage and resistance.
- Resistance range provides audible continuity test.
- Frequency response from 40Hz to 1kHz on AC current and voltage ranges.

	2017
AC A	200/600A ±1.5%rdg±4dgt[50/60Hz](200A) ±1%rdg±3dgt[50/60Hz](600A) ±2%rdg±5dgt[45Hz - 1kHz]
AC V	200/600V ±1%rdg±2dgt[50/60Hz] ±1.5%rdg±4dgt[45Hz - 1kHz]
Ω	200Ω ±1.2%rdg±2dgt
Continuity buzzer	buzzer sounds below 30±20Ω
Conductor size	φ33mm max.
Frequency response	45Hz - 1kHz
Applicable standards	IEC 61010-1 CAT III 600V Pollution degree 2
Power source	6F22(9V) × 1 *Continuous measuring time : approx. 200 hours
Dimensions	208(L) × 91(W) × 40(D)mm
Weight	400g approx.
Accessories	7066A(Test leads) 9079(Carrying case) 6F22 × 1 Instruction manual
Optional	8008(Multi-tran)



CE

## MODEL 2027

True RMS Ø33 MAX 600A AC A AC V Ω

DATA HOLD

- True RMS reading instrument that permits precise measurements of non-sinusoidal waveform AC current and voltage.
- Three functions in one unit; AC current, AC voltage and resistance.

	2027
AC A	200/600A(True RMS) ±1.5%rdg±4dgt[50/60Hz] (CF<3) ±2%rdg±5dgt[40Hz - 1kHz](Sine wave)
AC V	200/600V(True RMS) (CF<3) ±1.5%rdg±4dgt[50/60Hz] ±2%rdg±5dgt[40Hz - 1kHz]
Ω	200Ω ±1.2%rdg±4dgt
Continuity buzzer	buzzer sounds below 30±20Ω
Conductor size	φ33mm max.
Frequency response	40Hz - 1kHz
Applicable standards	IEC 61010-1 CAT III 600V Pollution degree 2
Power source	6F22(9V) × 1 *Continuous measuring time : approx. 200 hours)
Dimensions	208(L) × 91(W) × 40(D)mm
Weight	400g approx.
Accessories	7066A(Test leads) 9079(Carrying case) 6F22 × 1 Instruction manual
Optional	8008(Multi-tran)



CE

## MODEL 2031

Ø24 MAX 200A AC A DATA HOLD AUTO POWER OFF

- Can measure large AC current up to 200A.
- 24mm-dia tear drop shaped jaws.

	2031
AC A	20A ±2%rdg±5dgt[50Hz - 1kHz] 200A ±2%rdg±5dgt[50/60Hz] ±3%rdg±10dgt[40Hz - 1kHz]
Conductor size	φ24mm max.
Frequency response	40Hz - 1kHz
Applicable standards	IEC 61010-1 CAT III 300V
Power source	LR-44(1.5V) × 2 *Continuous measuring time : approx. 100 hours (Auto power off : approx. 10 minutes)
Dimensions	147(L) × 58.5(W) × 26(D)mm
Weight	100g approx.
Accessories	9090 (Carrying case) LR-44 × 2 Instruction manual
Optional	8008(Multi-tran)



# DIGITAL CLAMP METERS AC

## KEW 2210R **NEW**



CE

TRUE RMS CAT IV 600V Ø150 MAX 3000A AC A ☀  
DATA HOLD MAX/MIN AUTO POWER OFF

- Flexible and light weight clamp sensor
- Wide reading range up to 3000A
- True RMS
- MIN / MAX function
- Backlight LCD display
- IEC 61010-1 (CAT III 1000V / CAT IV 600V)

	2210R
AC A (RMS)	
Range	30.00 / 300.0 / 3000A
Accuracy	±3%rdg±5dgt (45 - 500Hz) (At the center of the circle formed by the flexible sensor)
Conductor size	φ150mm max.
Influence of Conductor position	Additional ±3% (max.) depending on the distance from the center position
Overload protection	5000A AC for 10 seconds
Applicable standards	IEC 61010-1, IEC 61010-2-030 CAT III 1000V / CAT IV 600V Pollution degree 2 IEC 61010-2-032, IEC 61326-1 (EMC), IEC 60529 IP40
Operating temperature & humidity	0 - +50°C, less than 80% RH (without condensation)
Storage temperature & humidity	-10 - +60°C, less than 70% RH (without condensation)
Power source	R03 / LR03 (AAA) (1.5V) × 2 *Continuous measuring time: approx. 120hours (Auto power off: approx. 15 minutes)
Dimensions	120 (L) × 70 (W) × 26 (D) mm : Display unit 1.8m : Sensor cable
Weight	Approx. 300g (including batteries)
Accessories	9174 (Carrying case), LR03 (AAA) × 2, Instruction manual

## KEW 2200/2200R **NEW**



CE

2200R  
TRUE RMS Ø33 MAX 1000A AC A DC V Ω  
DATA HOLD AUTO POWER OFF

- Ultra Slim and lightweight Handy design
- φ33mm Tear Drop Jaw easy to use in tight places.
- 1000A AC Clamp Meter
- DMM function ACV, DCV, Ω, Continuity Buzzer.
- Fuseless electronic protection on Ω/☉) up to 600V
- DMM function ACV, DCV, Ω, Continuity Buzzer.
- Safety Standard IEC 61010-1, 61010-2-032 CAT IV 300V\* / CAT III 600V \*2200R only

photo : 2200R

	2200	2200R
Detection method	Averaging value	RMS
AC A	40.00/400.0/1000A (Auto-ranging) ±1.4%rdg±6dgt(50/60Hz) ±1.6%rdg±6dgt(45 - 65Hz)	40.00/400.0/1000A (Auto-ranging) ±1.5%rdg±5dgt(45 - 65Hz) ±2.0%rdg±5dgt(40Hz - 1kHz)
AC V	4.000/40.00/400.0/600V (Auto-ranging) ±1.8%rdg±7dgt(45 - 65Hz) ±2.3%rdg±8dgt(65 - 500Hz)	
DC V	400.0mV/4.000/40.00/400.0/600V (Auto-ranging) ±1.0%rdg±3dgt* *400mV range is excluded	
Ω	400.0Ω/4.000/40.00/400.0kΩ/4.000/40.00MΩ (Auto-ranging) ±2.0%rdg±4dgt(0 - 400kΩ) ±4.0%rdg±4dgt(4MΩ) ±8.0%rdg±4dgt(40MΩ)	
Continuity buzzer	buzzer sounds below 50±30Ω	
Conductor size	φ33mm max.	
Applicable standards	IEC 61010-1 CAT IV 300V*, CAT III 600V Pollution degree2(AC A) *2200R only CAT III 300V, CAT II 600V Pollution degree2(AC/DC V) IEC 61010-031, IEC 61010-2-032, IEC 61326(EMC)	
Power source	R03/LR03(AAA)(1.5V) × 2	
Continuous measuring time	Approx.350 hours	Approx.120 hours
	Auto power off : approx.10 minutes	
Dimensions	190(L)x68(W)x20(D)mm / Approx.120g(including batteries)	
Accessories	7107A (Test leads), 9160 (Carrying case), R03(AAA)×2, Instruction manual	
Optional	8008(Multi-tran)	

## KEW 2040



CE

CAT IV 600V Ø33 MAX 600A AC A DC V Ω  
☉) Hz DUTY → DATA HOLD MAX/MIN  
REL AUTO POWER SAVE

- CAT IV Clamp Meters can measure the Voltage and Current in both very low and high power circuits.
- Thus, very useful for power distribution companies, power utilities and maintenance fields.
- Red LED, as "Non Contact Voltage" function, gives warning to the user on the presence of AC voltage.
- Double molding gives comfortable feeling in palm.
- 6039 counts with Bar Graph display.
- MIN./MAX. function enables to keep easily min. & max. value during measurement.

	2040
AC A	0 - 600.0A ±1.5%rdg±5dgt(50/60Hz) ±3.5%rdg±8dgt(40 - 400Hz)
AC V	6/60/600V (Auto Ranging) ±1.3%rdg±4dgt(50/60Hz) ±3.0%rdg±5dgt(40 - 400Hz)
DC V	600m/6/60/600V (Auto Ranging) ±1.0%rdg±3dgt
Ω	600/6k/60k/600k/6M/60MΩ (Auto Ranging) ±1%rdg±5dgt(600 - 6M) / ±5%rdg±8dgt(60M)
Continuity buzzer	Buzzer Sounds at 100Ω
Hz	10/100/1k/10kHz(Auto Ranging) (Input sensitivity Current:more than 50A [ - 1kHz] Voltage:more than 1V[ - 10kHz])
DUTY	0.1 - 99.9% (Pulse width / Pulse cycle) ±2.5%rdg±5dgt
Conductor size	φ33
Applicable standards	IEC 61010-1 CAT IV 600V IEC 61010-031 IEC 61010-2-032 IEC 61326
Power source	R03 (1.5V)(AAA) × 2 *Continuous measuring time : approx. 30 hours (Auto power save : approx. 15 minutes)
Dimensions	243(L) × 77(W) × 36(D) mm
Weight	300g
Accessories	7066A(Test leads) 9094(Carrying case) R03 × 2 Instruction manual
Optional	8008(Multi-tran)(AC only)

# DIGITAL CLAMP METERS AC/DC



CE

## KEW 2003A

CAT IV 600V Ø55 MAX 2000A DC AC A DC AC V Ω  
400ms  
DATA HOLD PEAK HOLD OUT PUT AUTO POWER SAVE

- Equipped to measure both AC and DC current with transformer jaws of large diameter.
- Can measure AC and DC currents up to 2000A.
- Output terminal for connection to recorders.
- AC/DC voltage, resistance measurement and continuity functions also available.

	2003A
AC A	400A/2000A(0 - 1000A) ±1.5%rdg±2dgt[50/60Hz] ±3%rdg±4dgt[40 - 500Hz] ±5%rdg±4dgt[500Hz - 1kHz] 2000A(1001 - 2000A) ±3%rdg±2dgt[50/60Hz]
DC A	400/2000A ±1.5%rdg±2dgt
AC V	400/750V ±1.5%rdg±2dgt[50/60Hz] ±1.5%rdg±4dgt[40Hz - 1kHz]
DC V	400/1000V ±1%rdg±2dgt
Ω	400/4000Ω ±1.5%rdg±2dgt
Continuity buzzer	buzzer sounds below 50±35Ω
Conductor size	φ55mm max.
Frequency response	40Hz - 1kHz
Output	Recorder: DC400mV against AC/DC400A DC200mV against AC/DC2000A
Applicable standards	IEC 61010-1 CAT IV 600V, CAT III 1000V IEC 61010-2-032
Power source	R6(AA)(1.5V) × 2 *Continuous measuring time : approx. 100 hours(Auto power save : approx. 10 minutes)
Dimensions	250(L) × 105(W) × 49(D)mm
Weight	530g approx.
Accessories	7107A(Test leads) 8201(Output plug) 9094(Carrying case) R6(AA) × 2 Instruction manual
Optional	7256(Output cord) 8008(Multi-tran)(AC only)



CE

## KEW 2009R

TRUE RMS CAT IV 600V Ø55 MAX 2000A DC AC A DC AC V  
10ms  
Ω Hz DATA HOLD PEAK HOLD OUT PUT  
AUTO POWER OFF

- True RMS reading instrument ideal for accurate measurement of distorted waveforms and non-sinusoidal waveforms arising from thyristors.
- Can measure AC and DC currents up to 2000A.
- Output terminal for connection to recorders.

	2009R
AC A	400.0/2000A ±1.3%rdg±3dgt(0 - 400A,150 - 1700A)(45 - 66Hz) ±2.0%rdg±5dgt(0 - 400A,150 - 1700A)(20Hz - 1kHz) ±2.3%rdg±3dgt(1701 - 2000A)(45 - 66Hz)
DC A	400.0/2000A ±1.3%rdg±2dgt
AC V	40.00/400.0/750V ±1.0%rdg±3dgt(45 - 66Hz) ±1.5%rdg±5dgt(20Hz - 1kHz)
DC V	40.00/400.0/1000V ±1.0%rdg±2dgt
Ω	400.0/4000Ω ±1.5%rdg±2dgt
Continuity buzzer	Buzzer sounds below 20Ω
Hz	10 - 4000Hz ±1.5%rdg±5dgt (Input sensitivity Current:more than 40A Voltage:more than 10V)
Output	Recorder: DC400mV against AC/DC400A DC200mV against AC/DC2000A
Conductor size	φ55mm max.
Applicable standards	IEC 61010-1 CAT IV 600V, CAT III 1000V IEC 61010-2-032, IEC 61326-1, IEC 61326-2-1
Power source	R6 (1.5V) × 2 *Continuous measuring time: approx. 15 hours (Auto power off: approx. 10 minutes)
Dimensions	250 (L) × 105 (W) × 49 (D) mm
Weight	Approx. 540g(including batteries)
Accessories	7107A(Test leads) 8201(Output plug) 9094(Carrying case) R6(AA)(1.5V)×2, Instruction manual
Optional	7256(Output cord) 8008(Multi-tran)(AC only)



## MODEL 2010

Ø7.5 MAX 20A DC AC A OUT PUT External Power Supply

- High sensitivity, miniature AC/DC clamp meter.
- 0.1mA minimum resolution for AC current and 1mA minimum resolution for DC current.
- Output terminal for recorder connection.

	2010
AC A	200mA/2/20A ±1%rdg±2dgt[50/60Hz](200mA) ±1.5%rdg±4dgt[40Hz - 2kHz](200mA) ±1%rdg±2dgt[50/60Hz](2A) ±2.5%rdg±5dgt[40Hz - 2kHz](2/20A)
DC A	2/20A ±1%rdg±2dgt(2A) ±1.5%rdg±4dgt(20A)
Conductor size	φ7.5mm max.
Frequency response	DC 40Hz - 2kHz
Output	Recorder: DC200mV against AC200mA/2/20A DC200mV against DC2/20A
Power source	6LR61(9V Alkaline battery) × 1 or AC adaptor *Continuous measuring time : approx. 20 hours (DC)/approx. 40 hours (AC)
Dimensions	142(L) × 64(W) × 26(D)mm : Display unit 153(L) × 23(W) × 18(D)mm : Sensor
Weight	220g approx.
Accessories	9071(Carrying Case) 6LR61 × 1 Instruction manual
Optional	7256(Output cord) 8022(AC adaptor)(110V) 8023(AC adaptor)(220V)

# DIGITAL CLAMP METERS AC/DC



CE

## MODEL 2033

Ø24 MAX 300A DC AC A DATA HOLD AUTO POWER SAVE

- Smallest clamp meter capable of AC and DC current measurements.
- 300A auto ranging has minimum resolution of 0.01A AC/DC.
- Auto-zero function to allow one touch zero adjustment.

	2033
AC A	40/300A ±1%rdg±4dgt[50/60Hz](0 - 40A) ±2.5%rdg±4dgt[20Hz - 1kHz](0 - 40A) ±1.5%rdg±4dgt[50/60Hz](20 - 200A) ±2.5%rdg±4dgt[20Hz - 1kHz](20 - 200A) ±3.5%rdg[50/60Hz](200 - 300A) ±4%rdg[20Hz - 1kHz](200 - 300A)
DC A	40/300A ±1%rdg±4dgt(0 - ±40A) ±1.5%rdg±4dgt(±20 - ±200A) ±3%rdg(±200 - ±300A)
Conductor size	φ24mm max.
Frequency response	DC 20Hz - 1kHz
Applicable standards	IEC 61010-1 CAT III 300V IEC 61010-2-032
Power source	LR-44(1.5V) × 2 *Continuous measuring time : approx. 10 hours (Auto power save : approx. 5 minutes)
Dimensions	147(L) × 59(W) × 25(D)mm
Weight	100g approx.
Accessories	9090 (Carrying case) LR-44 × 2 Instruction manual
Optional	8008(Multi-tran)(AC only)



CE

## KEW 2046R

RMS CAT IV 600V Ø33 MAX 600A DC AC V DC AC A  
Ω Hz DUTY 10ms PEAK HOLD MAX/MIN REL  
°C DATA HOLD AUTO POWER OFF

- Very useful for power distribution companies, power utilities and maintenance fields.
- Red LED, as "Non Contact Voltage" function, gives warning to the user on the presence of AC voltage.
- Double molding gives comfortable feeling in palm.
- 6039 counts with Bar Graph display.

	2046R
AC A	0 - 600.0A ±2.0%rdg±5dgt(50/60Hz) ±3.5%rdg±5dgt(40 - 500Hz)
DC A	0 - 600.0A ±1.5%rdg±5dgt
AC V	6/60/600V(Auto Ranging) ±1.5%rdg±4dgt(50/60Hz) ±3.5%rdg±5dgt(40 - 400Hz)
DC V	600m/6/60/600V(Auto Ranging) ±1.0%rdg±3dgt
Ω	600/6k/60k/600k/6M/60MΩ(Auto Ranging) ±1%rdg±5dgt(600 - 6M) / ±5%rdg±8dgt(60M)
Continuity buzzer	Buzzer Sounds at 100Ω
Hz	10/100/1k/10kHz(Auto Ranging) (Input sensitivity Current: more than 50A[ - 1kHz] Voltage: more than 1V[ - 10kHz])
DUTY	0.1 - 99.9% ±2.5%rdg ±5dgt (Pulse width/Pulse cycle)
Capacitance test	400n/4μ/40μF(Auto Ranging)
Temperature	-50°C - +300°C(with the use of Temperature probe 8216)
Conductor size	φ33
Applicable standards	IEC 61010-1 CAT IV 600V IEC 61010-2-032, IEC 61326
Power source	R03 (1.5V)(AAA) × 2 *Continuous measuring time : approx. 10 hours (Auto power off : approx. 15 minutes)
Dimensions	243(L) × 77(W) × 36(D) mm
Weight	300g
Accessories	7066A(Test leads) 9094(Carrying case) R03 × 2 Instruction manual
Optional	8008(Multi-tran)(AC only) 8216(Temperature probe)



CE

## KEW 2055/2056R

2056R RMS CAT IV 600V Ø40 MAX 1000A DC AC V DC AC A 2056R  
Ω Hz DUTY 10ms PEAK HOLD MAX/MIN REL  
°C DATA HOLD AUTO POWER SAVE AUTO POWER OFF

- Very useful for power distribution companies, power utilities and maintenance fields.
- Red LED, as "Non Contact Voltage" function, gives warning to the user on the presence of AC voltage.
- Double molding gives comfortable feeling in palm.
- 6039 counts with Bar Graph display.

	2055	2056R
AC A	0 - 600.0/1000A ±1.5%rdg±5dgt(50/60Hz) ±3.0%rdg±5dgt(40 - 400Hz)	0 - 600.0/1000A ±2.0%rdg±5dgt(50/60Hz) ±3.5%rdg±5dgt(40 - 500Hz)
DC A	0 - 600.0/1000A ±1.5%rdg±5dgt	
AC V	6/60/600V(Auto Ranging) ±1.3%rdg±4dgt(50/60Hz) ±3.0%rdg±5dgt(40 - 400Hz)	6/60/600V(Auto Ranging) ±1.5%rdg±4dgt(50/60Hz) ±3.5%rdg±5dgt(40 - 400Hz)
DC V	600m/6/60/600V(Auto Ranging) ±1.0%rdg±3dgt	
Ω	600/6k/60k/600k/6M/60MΩ (Auto Ranging) ±1%rdg±5dgt(600 - 6M) / ±5%rdg±8dgt(60M)	
Continuity buzzer	Buzzer Sounds at 100Ω	
Capacitance test	-	400n/4μ/40μF(Auto Ranging)
Temperature	-	-50°C - +300°C (with the use of Temperature probe 8216)
Hz	10/100/1k/10kHz(Auto Ranging) (Input sensitivity Current: more than 50A[ - 1kHz] Voltage: more than 1V[ - 10kHz])	
DUTY	0.1 - 99.9% ±2.5%rdg ±5dgt (Pulse width/Pulse cycle)	
Conductor size	φ40	
Applicable standards	IEC 61010-1 CAT IV 600V, IEC 61010-2-032, IEC 61326	
Power source	R03 (1.5V)(AAA) × 2 *Continuous measuring time : approx. 35 hours (Auto power save : approx. 15 minutes) (2055) *Continuous measuring time : approx. 10 hours (Auto power off : approx. 15 minutes) (2056R)	
Dimensions	254(L) × 82(W) × 36(D) mm	
Weight	310g	
Accessories	7066A(Test leads) 9094(Carrying case) R03 × 2 Instruction manual	
Optional	8008(Multi-tran)(AC only)	8008(Multi-tran)(AC only) 8216(Temperature probe)

photo : 2056R



# DC MILLIAMP CLAMP METER/FORK CURRENT TESTER

## KEW 2500

### DC MILLIAMP CLAMP METER

Ø6 DC A DATA HOLD AUTO POWER OFF OUT PUT



2500	
DC A	20/100mA(Auto ranging) ±0.2%rdg±5dgt(0.00mA - 21.49mA) ±1.0%rdg±5dgt(21.0mA - 120.0mA)
Conductor size	φ6mm max.
Analog output	Recorder: DC1000mV against DC100mA
Withstand voltage	2210V AC for 5 seconds
Applicable standards	IEC 61010-1, 61010-2-030 CAT II 300V IEC 61010-2-032 IEC 61326-1, 61326-2-2 IEC 60529 IP40
Operating temperature & humidity	-10 - +50°C < 85%
Storage temperature & humidity	-20 - +60°C < 85%
Power source	R6/LR6(AA) (1.5V) × 4
Dimensions	111(L) × 61(W) × 40(D)mm : Display unit 104(L) × 34(W) × 20(D)mm : Sensor 700mm : Sensor cable
Weight	Approx. 290g (including batteries)
Accessories	9096(Carrying case) LR6(AA) × 4 Instruction manual
Optional	7256(Output cord)



Diameter of measurable conductor : φ6mm max

#### Analog output terminal for recorder connection

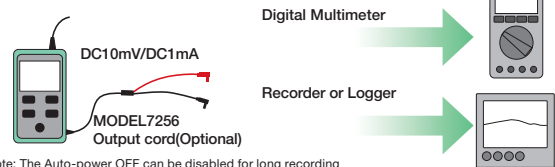

Note: The Auto-power OFF can be disabled for long recording

#### Dual display gives simultaneous readout of % values and measured values(mA)

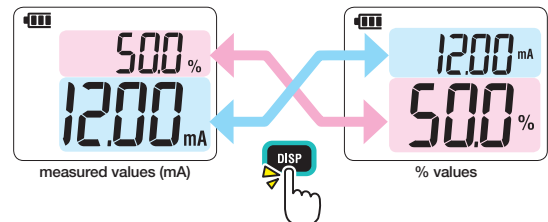

CE

- 0.01mA resolution for DC current
- Top class measurement 0.2% accuracy
- Ø6mm clamp jaw easy to use in tight places
- Measurement from 0.01mA to 120.0mA
- Dual display with backlight shows both mA measurement and percent of 4-20 mA span
- Spotlight for illuminating measurement point
- Analog output terminal for recorder connection
- Complies with IEC 61010-1 CAT II 300V

## MODEL 2300R

### KEW FORK CURRENT TESTER

True RMS Ø10 MAX 100A DC AC A DATA HOLD AUTO POWER OFF

- True RMS reading is an essential feature for accurate measurement.
- "Non Contact" voltage function indicates the presence of AC voltage by warning the user with an audible signal.
- Set the DC current range to zero in one touch with the Zero Adjust function.
- Auto Power Off.



KEW FORK 2300R can be used in crowded connection boxes, where cables are very short, and space is too limited to clamp cables using with a traditional clamp meter.

2300R	
Current measurement	AC A 0 - 100.0A ±2.0%rdg±5dgt (50/60Hz) DC A 0 - ±100.0A ±2.0%rdg±5dgt
Crest factor	2.5
Non contact voltage	Detect AC voltage without contacting with socket wire During voltage detection, "Hi" flashes and a buzzer sounds
Maximum digit	1,049
Conductor size	Max φ10mm
Applicable standards	IEC 61010-1 CAT III 300V Pollution degree 2
Power source	R03 (AAA) × 2 (Auto power off : approx. 10 minutes) *Continuous measuring time : AC A approx. 46 hours DC A approx. 52 hours
Dimensions	161.3(L) × 40.2(W) × 30.3(D)mm
Weight	110g (including batteries)
Accessories	9113(Carrying case) R03 (AAA) × 2 Instruction manual

CE

DC MILLIAMP CLAMP METER/FORK CURRENT TESTER

# LEAKAGE CLAMP METERS



CE

## MODEL 2431

Ø24 MAX 200A Resolution 0.01mA AC A DATA HOLD Filter

AUTO POWER OFF

- Frequency Selector Switch to eliminate the effect of harmonics.
- Auto power-off function
- Rotary switch for easy one finger power-on and range selection.

	2431
AC A (50/60Hz)	20/200mA/200A ±3%rdg±5dgt(20/200mA/100A) ±5%rdg±5dgt(200A)
AC A (WIDE)	20/200mA/200A ±2%rdg±4dgt[50/60Hz](20/200mA/0 - 100A) ±5%rdg±6dgt[40 - 400Hz](20/200mA/0 - 100A) ±5%rdg±4dgt[50/60Hz](100.1 - 200A)
Conductor size	φ24mm max.
Frequency response	40 - 400Hz
Effect of external stray magnetic field φ15mm 100A	10mA AC max.
Applicable standards	IEC 61010-1 CAT III 300V IEC 61010-2-032
Power source	LR-44(1.5V) × 2 *Continuous measuring time : approx. 15 hours (Auto power off : approx. 10 minutes)
Dimensions	149(L)× 60(W) × 26(D)mm
Weight	120g approx.
Accessories	9090 (Carrying case) LR-44 × 2 Instruction manual
Optional	8008(Multi-tran)*

\*These Multi-trans can not be used for leakage current measurement.



CE

## MODEL 2432

High Sensitive Model

Ø40 MAX 100A Resolution 0.001mA AC A DATA HOLD PEAK HOLD

Filter AUTO POWER OFF

- Frequency Selector Switch to eliminate the effect of harmonics.
- Three ranges: 4mA/40mA/100A.

	2432
AC A (50/60Hz)	4/40mA/100A ±1%rdg±5dgt(4/40mA) ±1%rdg±5dgt(0 - 80A) ±5%rdg(80.1 - 100A)
AC A (WIDE)	4/40mA/100A ±1%rdg±5dgt[50/60Hz] ±2.5%rdg±10dgt[20Hz - 1kHz](4/40mA) ±1%rdg±5dgt[50/60Hz] ±2.5%rdg±10dgt[40Hz - 1kHz](0 - 80A) ±5%rdg[50/60Hz] ±10%rdg[40Hz - 1kHz](80.1 - 100A)
Maximum circuit voltage	600V AC/DC (between line/neutral) 300V AC/DC (against earth)
Conductor size	φ40mm max.
Frequency response	20Hz - 1kHz(40Hz - 1kHz:100A)
Effect of external stray magnetic field	2mA AC approx. in proximity to a 15mm-dia conductor carrying 100A AC
Applicable standards	IEC 61010-1 CAT III 300V Pollution degree 2 IEC 61010-2-032
Power source	R03(DC1.5V) × 2 *Continuous measuring time : approx. 40 hours (Auto power off : approx. 10 minutes)
Dimensions	185(L) × 81(W) × 32(D)mm
Weight	290g approx.
Accessories	9097(Carrying case) R03(1.5V) × 2 Instruction manual
Optional	8008(Multi-tran) *

\*These Multi-trans can not be used for leakage current measurement.



CE

## MODEL 2433/2433R

2433R TRUE RMS Ø40 MAX 400A Resolution 0.01mA AC A DATA HOLD

10ms PEAK HOLD Filter AUTO POWER OFF

- Frequency Selector Switch to eliminate the effect of harmonics.
- Three ranges: 40mA/400mA/400A.

	2433/2433R
AC A (50/60Hz)	40/400mA/400A ±1%rdg±5dgt(40/400mA) ±1%rdg±5dgt(0 - 350A:2433, 0 - 300A:2433R) ±2%rdg(350.1 - 399.9A:2433, 300.1 - 399.9A:2433R)
AC A (WIDE)	40/400mA/400A ±1%rdg±5dgt[50/60Hz] ±2.5%rdg±10dgt[20Hz - 1kHz](40/400mA) ±1%rdg±5dgt[50/60Hz] ±2.5%rdg±10dgt[40Hz - 1kHz](0 - 350A:2433, 0 - 300A:2433R) ±2%rdg[50/60Hz] ±5%rdg[40Hz - 1kHz](350.1 - 399.9A:2433, 300.1 - 399.9A:2433R)
Maximum circuit voltage	600V AC/DC (between line/neutral) 300V AC/DC (against earth)
Conductor size	φ40mm max.
Frequency response	20Hz - 1kHz(40Hz - 1kHz:400A)
Effect of external stray magnetic field	10mA AC approx. in proximity to a 15mm-dia conductor carrying 100A AC
Applicable standards	IEC 61010-1 CAT III 300V Pollution degree 2 IEC 61010-2-032
Power source	R03 (DC1.5V) × 2 *Continuous measuring time : approx. 40 hours (2433) *Continuous measuring time : approx. 24 hours (2433R) (Auto power off : approx 10 minutes)
Dimensions	185(L) × 81(W) × 32(D)mm
Weight	270g approx.
Accessories	9097 (Carrying case) R03(1.5V) × 2 Instruction manual
Optional	8008 (Multi-tran)*

\*These Multi-trans can not be used for leakage current measurement.

photo : 2433R

# LEAKAGE CLAMP METERS

## KEW 2413F/2413R



2413R  
 True RMS **Ø68** MAX 1000A AC A DATA HOLD PEAK HOLD  
 Resolution 0.1mA OUT PUT Filter

- Large transformer jaws of 68mm diameter makes it possible to clamp on all three or four wires (3 phases) together for leakage current measurement.
- Frequency filter switch to eliminate the effect of the harmonics.
- 2 way analogue output terminal.

photo : 2413R

	2413F	2413R
AC A (50/60Hz)	200mA/2/20/200A/1000A ±1.5%rdg±2dgt(200mA/2/20A) ±2%rdg±2dgt(200A/0 - 500A) ±5.5%rdg(501 - 1000A)	200mA/2/20/200/1000A ±2.5%rdg±5dgt(200mA/2/20A) ±3.0%rdg±5dgt(200A/0 - 500A) ±5.5%rdg(501 - 1000A)
AC A (WIDE)	200mA/2/20/200A/1000A ±1%rdg±2dgt(50/60Hz) ±3%rdg±2dgt(40Hz - 1kHz)(200mA/2/20A) ±1.5%rdg±2dgt(50/60Hz) ±3.5%rdg±2dgt(40Hz - 1kHz)(200A/0 - 500A) ±5%rdg(50/60Hz) ±10%rdg(40Hz - 1kHz)(501 - 1000A)	200mA/2/20/200/1000A ±1.8%rdg±5dgt(50/60Hz) ±3.0%rdg±5dgt(40Hz - 1kHz)(200mA/2/20A) ±2.0%rdg±5dgt(50/60Hz) ±3.5%rdg±5dgt(40Hz - 1kHz)(200A/0 - 500A) ±5.0%rdg(50/60Hz)(501 - 1000A)
Conductor size	ø68mm max.	
Frequency response	40Hz - 1kHz	
Effect of external stray magnetic field ø15mm 100A	10mA AC max.	
Output	Waveform:AC200mV against the maximum value of each range (1000A range is 100mV) Recorder:DC200mV against the maximum value of each range (1000A range is 100mV)	
Crest factor	— 3.0 or Less	
Applicable standards	IEC 61010-1 CAT III 300V IEC 61010-2-032	
Power source	6F22(9V) × 1 *Continuous measuring time : approx. 60 hours	
Dimensions	250(L) × 130(W) × 50(D)mm	
Weight	570g approx.	600g approx.
Accessories	9094(Carrying case) 6F22 × 1	Instruction manual
Optional	7073(2WAY Output cord)	



## MODEL 2412



**Ø40** MAX 500A Resolution 0.01mA AC A AC V Ω  
 DATA HOLD OUT PUT Filter External Power Supply AUTO POWER OFF

- Digital clamp meter with tear drop shaped, medium size transformer jaws specially designed for leakage current measurement.
- Frequency filter switch to eliminate the effect of harmonics.

	2412
AC A (50/60Hz)	20/200mA/2/20/200/500A ±1.5%rdg±5dgt(20/200mA/2A) ±2%rdg±5dgt(20/200A) ±2.5%rdg±5dgt(500A)
AC A (WIDE)	20/200mA/2/20/200/500A ±1%rdg±3dgt(50/60Hz) ±5%rdg±5dgt(40 - 400Hz)(20/200mA/2A) ±1.5%rdg±3dgt(50/60Hz) ±5%rdg±5dgt(40 - 400Hz)(20/200A) ±2%rdg±3dgt(50/60Hz) ±5%rdg±5dgt(40 - 400Hz)(500A)
AC V	600V ±2%rdg±5dgt(50/60Hz) ±5%rdg±5dgt(40 - 400Hz)
Ω	200Ω ±1.5%rdg±5dgt
Conductor size	ø40mm max.
Frequency response	40 - 400Hz
Effect of external stray magnetic field ø15mm 100A	10mA AC max.
Output	Recorder:DC200mV against the maximum value of each range (500A range is 50mV)
Power source	6F22(9V) × 1 or AC adaptor *Continuous measuring time : approx. 100 hours (Auto power off : approx. 60 minutes)
Dimensions	209(L) × 96(W) × 45(D)mm
Weight	450g approx.
Accessories	7066A(Test leads) 9072(Carrying case) 8025(Output plug) 6F22 × 1 Instruction manual
Optional	8008(Multi-tran)* 8022(AC adaptor)(110V) 8023(AC adaptor)(220V) 7256(Output cord)

\*These Multi-trans can not be used for leakage current measurement.

## MODEL 2434



**Ø28** MAX 100A Resolution 0.1mA AC A DATA HOLD Filter  
 AUTO POWER SAVE

- Least affected by external stray magnetic field.
- 20mA AC max. in proximity to a 15mm-dia conductor carrying 100A AC.
- Frequency Selector Switch to eliminate the effect of harmonics.

	2434
AC A (50/60Hz)	400mA/4/100A ±2%rdg±4dgt
AC A (WIDE)	400mA/4/100A ±2%rdg±4dgt(50/60Hz) ±3%rdg±5dgt(40 - 400Hz)
Conductor size	ø28mm max.
Frequency response	40 - 400Hz
Effect of external stray magnetic field ø15mm 100A	20mA AC max.
Applicable standards	IEC 61010-1 CAT III 300V IEC 61010-2-032
Power source	R03(AAA) (1.5V) × 2 *Continuous measuring time : approx. 150 hours(Auto power save : approx. 10 minutes)
Dimensions	169(L) × 75(W) × 40(D)mm
Weight	220g approx.
Accessories	9097(Carrying case) R03 × 2 Instruction manual
Optional	8008(Multi-tran)*

\*These Multi-trans can not be used for leakage current measurement.





# CLAMP SENSOR/CLAMP ADAPTOR/MULTI-TRAN

## KEW 8115

### CLAMP SENSOR



AC DC  
 Ø12 MAX 130A MAX 180A DC AC A AUTO POWER OFF



- Permits extension of the AC and DC current ranges of almost any Digital Multimeters (DMMs) without breaking the circuit under test.
- Using KEW 8115 with KEW 1051/1052 (DMM) the display can be set for direct reading in A.

	8115	
Measuring range	AC 0.1 - 130Arms	DC 0 - ±180A
Output voltage	AC 10mV/A	DC 10mV/A
Accuracy	±1.2%rdg±0.4mV (50/60Hz) ±2.5%rdg±0.4mV (40Hz - 1kHz)	±1.2%rdg±0.4mV (*)
Low battery warning	2.2V±0.2V or less - Red LED flash (1.9V±0.2V - Automatically power off)	
Conductor size	φ12mm max.	
Operating temperature & humidity range	-10 to 55°C, relative humidity 85% or less (no condensation)	
Output impedance	Approx. 10Ω or less	
Applicable standards	IEC 61010-1 CAT III 300V Pollution degree 2, IEC 61010-2-032, IEC 61326-1	
Power source	DC3V (size AAA alkaline battery LR03×2pcs) Continuous use: approx. 40 hours(Auto power off: approx. 20 minutes)	
Cord length	Approx. 1,200mm	
Output connector	φ4mm banana plug	
Dimensions	127(L)×42(W)×22(D) mm	
Weight	Approx. 140g	
Accessories	Soft case, LR03×2, Instruction manual	

\*This accuracy is defined after the completion of the KEW 8115 zero-adjustment whilst connected to a DMM.

## MODEL 8112/8112BNC

### CLAMP ADAPTOR



Ø8 MAX 120A AC A



(8112 Only) photo : 8112

Model 8112 clamp adaptor is designed to be an AC current/voltage conversion probe capable of measuring AC current from 0.1mA to 120A in conjunction with digital multimeters.

Model 8112BNC is an AC clamp adaptor designed for use with oscilloscopes. Output cord has a BNC connector which enables direct observation of current waveform on oscilloscope. Specifications are same as those for Model 8112.

		8112/8112BNC		
Range	Measuring ranges	Output voltage	Accuracy	Frequency response
200mA	AC 0 - 500mA	AC1V/A	±1.5%rdg±0.2mA	50Hz - 1kHz
	AC 0 - 1000mA	(1000mA→1V)	±3%rdg±0.4mA	40Hz - 10kHz
2A	AC 0 - 20A	AC100mV/A	±1%rdg±1mA	40Hz - 1kHz
		(20A→2V)	±1.5%rdg±2mA	1k - 10kHz
20A	AC 0 - 20A	AC10mV/A	±1%rdg±0.01A	40Hz - 1kHz
	AC 20 - 60A	(120A→1.2V)	±2.5%rdg	50Hz - 10kHz
	AC 60 - 120A		±2.5%rdg	100Hz - 10kHz
Conductor size	φ8mm max.			
Frequency characteristics	30Hz - 100kHz(-3dB)			
Applicable standard	IEC 61010-1 CAT II 100V Pollution degree 2(8112 Only).			
Dimensions	153(L) × 18(W) × 23(D)mm			
Weight	100g approx.			
Accessories	9057(Carrying case) Instruction manual			

## MODEL 8008

### MULTI-TRAN

Ø100 MAX 3000A AC A

Adaptor designed to increase the measuring capability of your clamp meters. With the use of the multi-tran you can not only extend current ranges but also clamp on a conductor of larger diameter.



	8008
Measuring range	0 - 3000A AC
Ratio/Range	10 : 1 (input to output)
Accuracy	±2% of input±0.5A
Allowable measurement time	0 - 1000A(continuous) 1000 - 1500A(10 minutes max.) 3000A(30 seconds max.)
Conductor size	φ100mm max.(100 × 150mm)
Frequency response	50Hz/60Hz
Safety standard	IEC 61010-1 CAT III 300V Pollution degree 2
Dimensions	317(L) × 150(W) × 30(D)mm 45(L) × 40(W) × 10(D)mm Output coil
Weight	750g approx.
Accessories	9056(Carrying case)

\*These Multi-trans can not be used for leakage current measurement.

# INSULATION TESTERS

INSULATION TESTERS





















# INSULATION TESTERS

## Selection Guide of Insulation Testers

	Analogue Insulation Testers			Analogue Insulation/Continuity Testers	
	3165	3166	3161A	3131A	3132A
Appearance	 photo : 3165				
Test voltage	1 range		2 ranges	3 ranges	
Rated voltage (Max. measurement value)	500V(1000M $\Omega$ )	1000V(2000M $\Omega$ )	15V(20M $\Omega$ ) 500V(100M $\Omega$ )	250V(100M $\Omega$ ) 500V(200M $\Omega$ ) 1000V(400M $\Omega$ )	250V(100M $\Omega$ ) 500V(200M $\Omega$ ) 1000V(400M $\Omega$ )
Continuity 	-	-	-	2/20 $\Omega$	3/500 $\Omega$
AC Voltage 	600V	600V	600V	-	600V
Back light 	-	-	✓	✓	-
Power source	R6 x 4	R6 x 4	R6 x 4	R6 x 6	R6 x 6
Dimensions (L)x(W)x(D)mm	90x137x40	90x137x40	90x137x40	167x185x89	106x160x72
Weight(Approx.)	330g	330g	340g	860g	560g

	Digital Insulation/Continuity Testers				
	3005A	3007A	3021	3022	3023
Appearance			 photo : 3021		
Test voltage	3 ranges		4 ranges		
Rated voltage (Max. measurement value)	250V(20M $\Omega$ ) 500V(200M $\Omega$ ) 1000V(2000M $\Omega$ )	250V(20M $\Omega$ ) 500V(200M $\Omega$ ) 1000V(2000M $\Omega$ )	125V(200M $\Omega$ ) 250V(2000M $\Omega$ ) 500V(2000M $\Omega$ ) 1000V(2000M $\Omega$ )	50V(200M $\Omega$ ) 100V(200M $\Omega$ ) 250V(2000M $\Omega$ ) 500V(2000M $\Omega$ )	100V(200M $\Omega$ ) 250V(2000M $\Omega$ ) 500V(2000M $\Omega$ ) 1000V(2000M $\Omega$ )
Continuity 	20/200/2000 $\Omega$	20/200/2000 $\Omega$	40/400 $\Omega$	40/400 $\Omega$	40/400 $\Omega$
Continuity buzzer 	✓	✓	✓	✓	✓
AC Voltage 	600V	600V	20 - 600V	20 - 600V	20 - 600V
DC Voltage 	-	-	-20 - -600V 20 - 600V	-20 - -600V 20 - 600V	-20 - -600V 20 - 600V
Back light 	-	✓	✓	✓	✓
Power source	R6 x 4	R6 x 4	R6 x 6	R6 x 6	R6 x 6
Dimensions (L)x(W)x(D)mm	167x185x89	167x185x89	105x158x70	105x158x70	105x158x70
Weight(Approx.)	970g	990g	600g	600g	600g

	Analogue High Voltage Insulation Testers			Digital High Voltage Insulation Testers			
	3121B/3122B	3123A	3124	3025A/3125A	3126	3127	3128
Appearance	 photo : 3121B			 photo : 3125A			
Test voltage	1 range	2 ranges	Variable	3025A: 4 ranges 3125A: 5 ranges	4 ranges	5 ranges	6 ranges(Variable)
Rated voltage (Max. measurement value)	3121B: 2500V(100G $\Omega$ ) 3122B: 5000V(200G $\Omega$ )	5000V(200G $\Omega$ ) 10000V(400G $\Omega$ )	1000V(100M $\Omega$ ) 1k - 10kV(100G $\Omega$ )	250V(100M $\Omega$ ) 500V(1000M $\Omega$ ) 1000V(2G $\Omega$ ) 2500V(100G $\Omega$ ) 5000V(1000G $\Omega$ )*	500V(999M $\Omega$ ) 1000V(1.99G $\Omega$ ) 2500V(99.9G $\Omega$ ) 5000V(1000G $\Omega$ )	250V(9.9G $\Omega$ ) 500V(99.9G $\Omega$ ) 1000V(999G $\Omega$ ) 2500V(999G $\Omega$ ) 5000V(9.99T $\Omega$ )	500V(500G $\Omega$ ) 1000V(1T $\Omega$ ) 2500V(2.5T $\Omega$ ) 5000V(5T $\Omega$ ) 10000V(35T $\Omega$ ) 12000V(35T $\Omega$ )
AC/DC Voltage 	-	-	-	30 - 600V AC/DC	30 - 600V AC/DC	30 - 600V AC/DC	30 - 600V AC/DC
Back light 	-	-	-	✓	✓	✓	✓
Current	-	-	-	-	-	0.00nA - 5.50mA	5.00nA - 2.40mA
Capacitance	-	-	-	-	-	5.0nF - 50.0 $\mu$ F*	5.0nF - 50.0 $\mu$ F*
Power source	LR14 x 8	R6 x 8	Ni-Cd rechargeable battery(1.2V) x 8	LR14 x 8	LR14 x 8	Rechargeable lead storage battery (12V)	Rechargeable lead storage battery (12V)
Dimensions (L)x(W)x(D)mm	177x226x100	200x140x80	200x140x80	177x226x100	205x152x94	380x430x154 (Instrument and Hard case)	330x410x180 (Instrument and Hard case)
Weight(Approx.)	3121B: 1600g 3122B: 1700g	1000g	1500g	3025A: 1700g 3125A: 1900g	1800g	8000g	9000g

\*3125A only

\*At 5000V range 5.0nF~ 25.0 $\mu$ F

\*At 10000/12000V range 5.0nF~ 1.0 $\mu$ F



# DIGITAL INSULATION/CONTINUITY TESTERS

DIGITAL INSULATION/CONTINUITY TESTERS

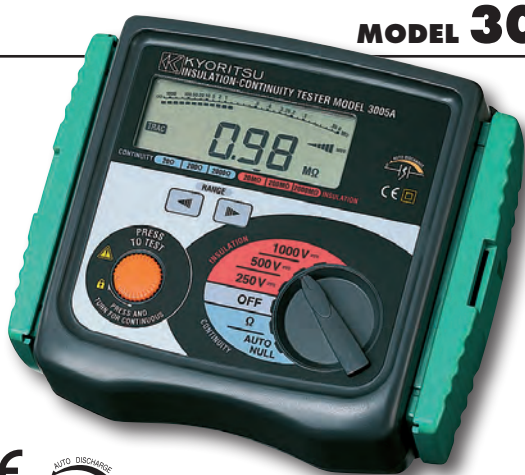

**MODEL 3005A**



**MODEL 3007A**

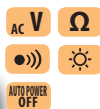

## Features (3005A/3007A)

- Bar graph to display insulation resistance.
- Displays the value of external AC voltage along with flashing symbol.
- Auto null function to automatically subtract the test lead resistance before displaying the real continuity resistance value.
- Trac-Lok mode to conserve battery life on insulation and continuity tests (Model 3007A only).
- Live circuit warning beeper.
- Releasing the test button automatically discharges the charges stored in the circuit under test.
- Backlight function to view the test results in dimly lit areas (Model 3007A only).
- 200mA continuity measuring current to IEC 61557.
- Minimum 1mA current on insulation tests to IEC 61557.

	3005A/3007A	
<b>Insulation resistance</b>		
Test voltage	250V/500V/1000V	
Measuring ranges	20MΩ/200MΩ/2000MΩ	
Output voltage on open circuit	Rated test voltage +20%, -0%	
Nominal current	1mA DC min.	
Output short circuit current	1.5 mA DC approx.	
Accuracy	±1.5%rdg±5dgt(20MΩ/200MΩ)	±10%rdg±3dgt(2000MΩ)
<b>Continuity test</b>		
Measuring ranges	20Ω/200Ω/2000Ω	
Output voltage on open circuit	7 - 12V DC	
Measuring current	200mA DC min.	
Accuracy	±1.5%rdg±5dgt(20Ω)	±1.5%rdg±3dgt(200Ω/2000Ω)
<b>AC voltage</b>		
AC voltage range	0 - 600V AC	
Accuracy	±5%rdg±3dgt	
<b>General</b>		
Applicable standards	IEC 61010-1 CAT III 300V Pollution degree 2 IEC 61557-1/2/4 IEC 60529(IP54) IEC 61326-1(EMC)	
Power source	R6(AA)(1.5V) × 8	
Dimensions	167(L) × 185(W) × 89(D)mm	
Weight	990g approx.(3007A) 970g approx.(3005A)	
Accessories	7122B(Test leads) 9074(Cord case) 8923(Fuse[F500mA/600V]) × 2 R6(AA) × 8 9121(Shoulder strap) Instruction manual	

## Accessory



## Selection Guide

	3005A	3007A
250V test voltage	✓	✓
500V test voltage	✓	✓
1000V test voltage	✓	✓
200mA continuity range	✓	✓
Live circuit warning	✓	✓
Illuminated scale		✓
Automatic discharge	✓	✓
Trac-loc for extended battery life		✓

# DIGITAL INSULATION/CONTINUITY TESTERS

## KEW 3021/3022/3023



- 3 functions in one unit, insulation test with 4 voltage ranges, continuity test, AC voltage measurement.
- 200mA measuring current on continuity testing.
- Comparator function with PASS / FAIL and buzzer.
- 0Ω adjustment at continuity measuring range.
- Memory function up to 99 data.
- Backlight LCD provides easy reading in dark locations.
- Safety lock system prevents an erroneous operation



photo : 3021

	3021				3022				3023			
Insulation resistance												
Test voltage	125V	250V	500V	1000V	50V	100V	250V	500V	100V	250V	500V	1000V
Measuring range (Auto range)	4.000/40.00/200.0MΩ				4.000/40.00/200.0MΩ		4.000/40.00/400.0/2000MΩ		4.000/40.00/200.0MΩ		4.000/40.00/400.0/2000MΩ	
First effective measuring range	0.2 - 20MΩ		0.2 - 40MΩ		0.2 - 200MΩ		0.2 - 1000MΩ		0.2 - 20MΩ		0.2 - 40MΩ	
Mid-scale value	5MΩ		50MΩ		5MΩ		50MΩ		5MΩ		50MΩ	
Accuracy	±2%rdg±6dgt											
Second effective measuring range lower	0.110 - 0.199MΩ											
Second effective measuring range upper	20.01 - 200.0MΩ		40.01 - 2000MΩ		200.1 - 2000MΩ		1001 - 2000MΩ		20.01 - 200.0MΩ		40.01 - 2000MΩ	
Accuracy	±5%rdg±6dgt											
Rated current	DC 1 - 1.2mA											
Output short circuit current	1.5mA max											
Ω/Continuity												
Auto range	40.00/400.0Ω											
Accuracy	±2%rdg±8dgt											
Output voltage on open circuit	5V±20%											
Output short circuit current	DC 220±20mA											
Fuse	Quick acting ceramic fuse 0.5A/600V(φ6.35×32mm)											
AC voltage												
Range	AC 20 - 600V(50/60Hz) DC -20 - -600V/+20 - +600V											
Accuracy	±3%rdg±6dgt											
General												
Applicable standards	IEC 61010-1 CAT III 600V IEC 61557-1,2,4 IEC 61326-1(EMC) IEC 60529(IP40)											
Dimensions / Weight	105(L) × 158(W) × 70(D)mm / 600g approx.											
Power source	R6×6 or LR6×6											
Accessories	7150A(Test Lead with remote control switch set) 9121(Shoulder strap) R6(AA) × 6 Instruction manual											
Optional	7115(Extension probe) 8016(Hook type prod) 8923(Fuse[0.5A/600V]) 9089(Carrying case)											

### Accessories

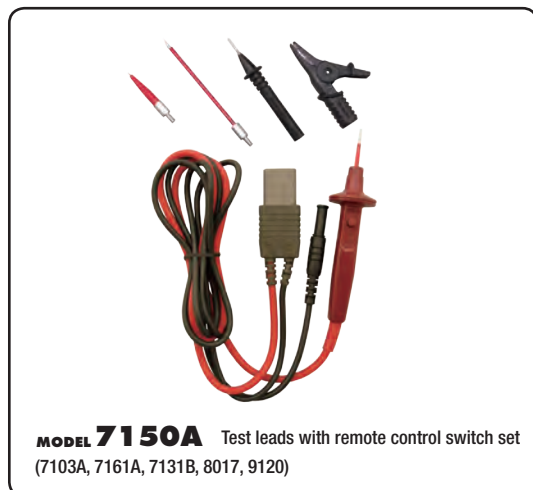

### Optional Accessories

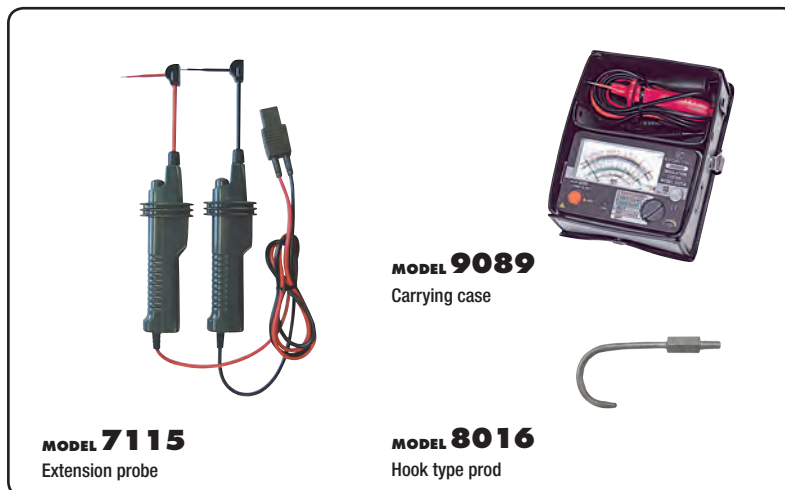

# ANALOGUE INSULATION/CONTINUITY TESTERS

## MODEL 3131A



- Test insulation up to 100M $\Omega$  at 250V, 200M $\Omega$  at 500V, 400M $\Omega$  at 1000V and continuity up to 20 $\Omega$ .
- LIVE circuit warning lamp plus audible warning.
- Automatic discharge of circuit capacitance when TEST button is released.
- Fuse protected (continuity range only).
- Battery check LED.
- Front panel zero adjust.
- Back light function to facilitate working at dimly lit situations.
- PRESS TO TEST button with lock down feature.

3131A	
Insulation resistance	
Test voltage	250V/500V/1000V
Measuring ranges (Mid-scale value)	100M $\Omega$ /200M $\Omega$ /400M $\Omega$ (1M $\Omega$ ) (2M $\Omega$ ) (4M $\Omega$ )
Output voltage on open circuit	Rated test voltage +20%, -0%
Nominal current	1mA DC min.
Output short circuit current	1.3 mA DC approx.
Accuracy	0.1 - 10M $\Omega$ /0.2 - 20M $\Omega$ /0.4 - 40M $\Omega$ (Accuracy guaranteed ranges) $\pm$ 5% of indicated value
Continuity	
Measuring ranges (Mid-scale value)	2 $\Omega$ /20 $\Omega$ (1 $\Omega$ )(10 $\Omega$ )
Output voltage on open circuit	4 - 9V DC
Measuring current	200mA DC min.
Accuracy	$\pm$ 3% of scale length
General	
Applicable standards	IEC 61010-1 CAT III 300V Pollution degree 2 IEC 61557-1/2/4 IEC 60529(IP54) IEC 61326-1(EMC)
Power source	R6(AA)(1.5V) $\times$ 6
Dimensions	167(L) $\times$ 185(W) $\times$ 89(D)mm
Weight	860g approx.
Accessories	7122B(Test leads) 9074(Cord case) 8923(Fuse[0.5A/600V]) $\times$ 2 R6(AA) $\times$ 6 9121(Shoulder strap) Instruction manual

## MODEL 3132A



- Dust and drip proof construction. (designed to IEC 60529 IP54)
- Designed to meet IEC 61010-1 and IEC 61557 safety standard.
- 1mA rated test current at the minimum resistance.
- 200mA measuring current on continuity testing.
- Automatic discharge of circuit capacitance. (Any charge stored in the circuit under test will be automatically discharged after testing.)
- Live circuit warning buzzer and neon lamp.
- Small and lightweight. Shock resistant new case material.
- AC voltmeter with linear, easy-to-read scale.
- Operates on AA, R6 $\times$ 6 dry batteries.

3132A	
Insulation resistance	
Test voltage	250V/500V/1000V
Measuring ranges (Mid-scale value)	100M $\Omega$ /200M $\Omega$ /400M $\Omega$ (1M $\Omega$ ) (2M $\Omega$ ) (4M $\Omega$ )
Output voltage on open circuit	Rated test voltage +20%, -0%
Nominal current	1mA DC min.
Output short circuit current	1 - 2mA DC
Accuracy	0.1 - 10M $\Omega$ /0.2 - 20M $\Omega$ /0.4 - 40M $\Omega$ (Accuracy guaranteed ranges) $\pm$ 5% of indicated value
Continuity	
Measuring ranges (Mid-scale value)	3 $\Omega$ /500 $\Omega$ (1.5 $\Omega$ /20 $\Omega$ )
Output voltage on open circuit	4.1V DC approx.
Measuring current	210mA DC min.
Accuracy	$\pm$ 1.5% of scale length
AC voltage	
AC voltage range	0 - 600V AC
Accuracy	$\pm$ 5% of scale length
General	
Applicable standards	IEC 61010-1 CAT III 600V Pollution degree 2 IEC 61557-1/2/4 IEC 60529(IP54) IEC 61326-1(EMC)
Power source	R6(AA)(1.5V) $\times$ 6
Dimensions	106(L) $\times$ 160(W) $\times$ 72(D)mm
Weight	560g approx.
Accessories	7122B(Test leads) 9074(Cord case) 8923(Fuse[0.5A/600V]) $\times$ 2 R6(AA) $\times$ 6 9121(Shoulder strap) Instruction manual

## Accessory



## Selection Guide

	3131A	3132A
3 range insulation test voltage	✓	✓
200mA continuity	✓	✓
Live circuit warning	✓	✓
AC voltage range		✓
Illuminated scale	✓	
Automatic discharge	✓	✓
IP54 rate	✓	✓



# ANALOGUE INSULATION TESTERS

## MODEL 3161A



- Miniature lightweight insulation tester. It weighs only 340g(battery included), but carries full measurement functions.
- Automatic discharge of circuit capacitance.
- Test leads with remote control switch .
- New robust housing case.
- Back light function.

	3161A
Insulation resistance	
Test Voltage	15V/500V
Max. effective scale value	20M $\Omega$ /100M $\Omega$
Mid-scale value	0.05M $\Omega$ /2M $\Omega$
First effective measuring ranges	0.005 - 2M $\Omega$ /0.1 - 50M $\Omega$
Accuracy	$\pm$ 5% of indicated value
Second effective measuring ranges	Measuring ranges other than above, 0 and $\infty$
Accuracy	$\pm$ 10% of indicated value
AC voltage	
AC voltage range	600V
Accuracy	$\pm$ 3% of full scale value
Applicable standards	IEC 61010-1 CAT III 300V, CAT II 600V
Power source	R6(AA)(1.5V) $\times$ 4
Dimensions	90(L) $\times$ 137(W) $\times$ 40(D)mm
Weight	340g approx.
Accessories	7149A(Test leads with remote control switch set) 9123(Shoulder strap) R6(AA) $\times$ 4 Instruction manual
Optional	7116(Extension probe) 8016(Hook type prod)

## Accessories



**MODEL 7149A** Test leads with remote control switch set  
(7139A, 7161A, 7131B, 8017, 9041)

## Optional Accessories

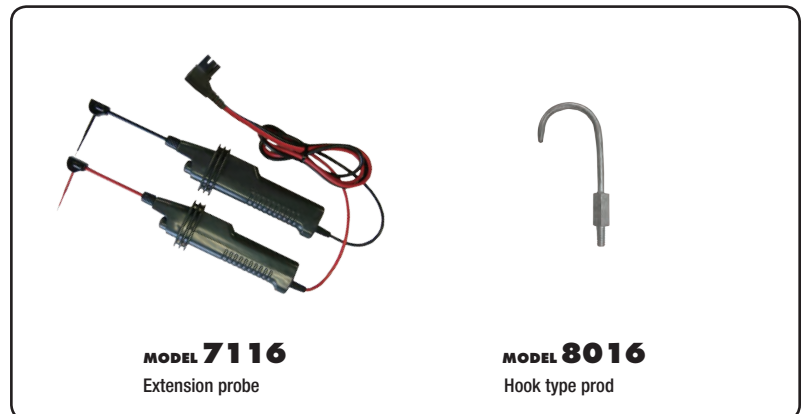

**MODEL 7116**  
Extension probe

**MODEL 8016**  
Hook type prod

## MODEL 3165/3166



photo : 3165

- 500V/1000M $\Omega$  (Model 3165)
- 1000V/2000M $\Omega$  (Model 3166)
- Expanded megohm scale for easy reading.
- New robust housing case to prevent damage.
- AC voltmeter scale for easy reading.

	3165	3166
Insulation resistance		
Test voltage	500V	1000V
Max. effective scale value	1000M $\Omega$	2000M $\Omega$
Mid-scale value	20M $\Omega$	50M $\Omega$
First effective measuring range	1 - 500M $\Omega$	2 - 1000M $\Omega$
Accuracy	$\pm$ 5% rdg	
Second effective measuring range	0.5/1000M $\Omega$	1/2000M $\Omega$
Accuracy	$\pm$ 10% rdg	
AC voltage		
AC voltage range	600V	
Accuracy	$\pm$ 3% of full scale value	
Power source	R6(AA)(1.5V) $\times$ 4	
Dimensions	90(L) $\times$ 137(W) $\times$ 40(D)mm	
Weight	330g approx.	
Accessories	7025(Test leads) 9074(Cord case) 9123(Shoulder strap) R6(AA) $\times$ 4 Instruction manual	

# HIGH VOLTAGE INSULATION TESTERS

12000V

## KEW 3128

CAT IV 600V DC AC V USB AUTO POWER OFF

- Test Voltage 12kV (max), Resistance 35TΩ (max).
- Short-Circuit Current 5mA (max).
- Graphic representation of the insulation resistance and leakage current versus time on large display with bar graph and backlight.
- Print Screen Function enables to record up to 32 display screens.
- Internal Memory can store about 43,000 data (max).
- Can be operated from internal rechargeable battery or from AC line.
- Robust design for field use with IP64 rating (with lid closed).

### Function

PI DAR DD SV



HIGH VOLTAGE INSULATION TESTERS

		3128						
Insulation resistance	Test voltage	500V	1000V	2500V	5000V	10000V	12000V	
	Max measurement value	500GΩ	1TΩ	2.5TΩ	5TΩ	35TΩ		
	Accuracy	400kΩ - 50GΩ ±5%rdg±3dgt	800kΩ - 100GΩ ±5%rdg±3dgt	2MΩ - 250GΩ ±5%rdg±3dgt	4MΩ - 500GΩ ±5%rdg±3dgt	8MΩ - 1TΩ ±5%rdg±3dgt		
		50G - 500GΩ ±20%rdg	100G - 1TΩ ±20%rdg	250G - 2.5TΩ ±20%rdg	500G - 5TΩ ±20%rdg	1T - 10TΩ ±20%rdg	10T - 35TΩ Values are displayed, but accuracy isn't guaranteed	
	Short circuit current	Max 5.0mA						
Load resistor to output rated voltage	0.5MΩ or more	1MΩ or more	2.5MΩ or more	5MΩ or more	20MΩ or more	24MΩ or more		
Output voltage	Rated voltage	500V	1000V	2500V	5000V	10000V	12000V	
	Monitor accuracy	±10%±20V						
	Output accuracy	0 - +20%	0 - +10%	0 - +10%	0 - +10%	-5 - +5%	-5 - +5%	
Voltage measurement	Selectable range	50 - 600V (in steps of 5V)	610 - 1200V (in steps of 10V)	1225 - 3000V (in steps of 25V)	3050 - 6000V (in steps of 50V)	6100 - 10000V (in steps of 100V)	10100 - 12000V (in steps of 100V)	
	Measuring range	DCV : ±30 - ±600V, ACV : 30 - 600V(50/60Hz)						
Current measurement	Accuracy	±2%rdg±3dgt						
	Measuring range	5.0nA - 2.40mA(Depending on the insulation resistance)						
Capacitance measurement	Accuracy	±5%rdg±5dgt						
	Measuring range	5.0nF - 50.0μF				5.0nF - 1.0μF (Display range : 5.0nF - 50.0μF)		
General	Applicable standards	IEC 61010-1 CAT IV 600V Pollution degree 2, IEC 61326, IEC 60529(IP64): with the lid closed.						
	Power source	Rechargeable Lead storage battery (12V *Charging time : approx. 8 hours) / AC Power supply (100V - 240V, 50/60Hz) ※Continuous measuring time: approx. 4 hours a load of 100MΩ at the Insulation resistance 12000V Range.						
	Dimensions	330(L) × 410(W) × 180(D)mm *Instrument and Hard case						
	Weight	9kg approx. (including battery) *Instrument and Hard case						
	Accessories	7170(Power cord), 7224A(Earth cord), 7225A(Guard cord), 7226A(Line probe), 7227A(Line probe with alligator clip), 8029(Extension prod), 8255(CAT IV Standard prod), 8212-USB-W(USB adaptor with KEW Windows(Software)), Instruction manual						
	Optional	7254(Longer line plode with alligator clip)(15m)						

### Large Graphical Display

Graphic representation of the insulation resistance and leakage current versus time on large display with bar graph and backlight.

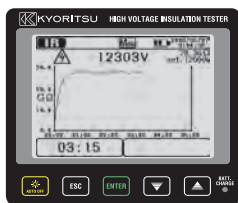

### "KEW Windows" Software for report

The stored data can be transferred to PC via MODEL8212-USB.



#### System requirements

OS: Windows Vista/7(32/64bit)/8(32/64bit)  
Display: XGA (Resolution 1024 × 768 dots) or more  
Hard-disk: Space required 100Mbyte or more  
Others: With CD-ROM drive and USB port  
NET Framework(2.0 or more)  
\* Windows® is a registered trademark of Microsoft in the United States.

### Optional Accessory

#### MODEL 7254

Longer line probe with alligator clip : 15m



### Diagnostic Insulation Tests

#### PI

#### Polarization Index

PI =  $\frac{\text{Insulation resistance value 10 min. after start}}{\text{Insulation resistance value 1 min. after start}}$

PI Criteria	4.0 or more	4.0-2.0	2.0-1.0	1.0 or less
	Best	Good	Warning	Bad

#### DAR

#### Dielectric Absorption Ratio

DAR =  $\frac{\text{Insulation resistance value 1 min. after start}}{\text{Insulation resistance value *15 sec. after start}}$

DAR Criteria	1.4 or more	1.25-1.0	1.0 or less
	Best	Good	Bad

\*User-Selectable 15sec. or 30sec. interval

#### DD

#### Dielectric Discharge

DD =  $\frac{\text{Current value 1 min. after completing (mA)}}{\text{Voltage value when a measurement complete (V) x Capacitance (F)}}$

DD Criteria	2.0 or less	2.0-4.0	4.0-7.0	7.0 or more
	Good	Warning	Poor	Very poor

# HIGH VOLTAGE INSULATION TESTERS



5000V

KEW **3127** **NEW**

CAT IV 600V DC AC V USB Bluetooth

- Insulation Resistance up to 10TΩ
- Short-Circuit Current up to 5mA
- Wide Test Voltage from 250V to 5000V
- Diagnostic Insulation Tests: IR, PI, DAR, DD, SV, RAMP.
- Wireless communication by Bluetooth for transferring and showing real-time data to PC and Android device.
- Memory and Logging functions.
- Filter function reduces noise interference.
- Robust design for field use with IP65 (lid closed).
- Powered by rechargeable battery.

Function

**PI DAR DD SV RAMP**



		3127					
Insulation resistance							
Test voltage		250V *1	500V	1000V	2500V	5000V	
Max measurement value		9.99GΩ	99.9GΩ	199GΩ	999GΩ	9.99TΩ	
Accuracy		0.0 - 99.9MΩ ±5%rdg±3dgt	0.0 - 999MΩ ±5%rdg±3dgt	0.0 - 1.99GΩ ±5%rdg±3dgt	0.0 - 99.9GΩ ±5%rdg±3dgt	0.0 - 99.9GΩ ±5%rdg±3dgt	
		0.1G - 9.99GΩ ±20%rdg	1G - 99.9GΩ ±20%rdg	2G - 199GΩ ±20%rdg	100G - 999GΩ ±20%rdg	0.1T - 9.99TΩ ±20%rdg	
Short circuit current		Max 5.0mA					
Output voltage	Accuracy	-10 - +10%	-10 - +20%	0 - +20%			
	Variable					-20% - 0% (5%step)	
	Monitor	±10%rdg±20V					
Measuring range		Voltage measurement		Current measurement	Capacitance measurement		
		AC:30 - 600V (50/60Hz) DC:±30 - ±600V		0.00nA - 5.50mA	5.0nF - 50.0μF *2		
Accuracy		±2%rdg±3dgt		±10%rdg*3	±5%rdg±5dgt		
Power source		Rechargeable Battery (Lead-acid Battery) 12V*4 Charging power : DC 15VA MAX					
Communication Interface		Bluetooth:Ver2.1 + EDR Class2 , USB:Ver1.1					
Applicable standards		IEC 61010-1, 61010-2-030 CAT IV 600V Pollution degree2, IEC 61326-1, 2-2					
Dimension		208(L) x 225(W) x 130(D) mm (Hard case 380(L) x 430(W) x 154(D) mm)					
Weight		3127:4kg Approx. (including battery), Total:8kg Approx. (including Accessories)					
Accessories		7165A(Line probe), 7224A(Earth cord), 7225A(Guard cord), 8019(Hook type prod), 8327EU(Power adaptor 15V/1A), 9171(Carrying case[Hard]), Instruction manual					
Optional		7168A(Line probe with alligator clip:3m), 7253(Longer line probe with alligator clip:15m), 8258(USB communication set), 8302(Adaptor for recorder 1mV/1μA)					

\*1) IR mode only \*2) At 5000V range 5.0nF-25.0μF \*3) Determined by resistance and Voltage values (over 10MΩ) \*4) No measurements are possible while charging ※ Bluetooth is a registered trademark of the Bluetooth SIG, Inc.

## SV SV Measurement (Step Voltage)

During the test, the applied voltage incrementally steps by a certain voltage taking successive 5-time measurement. Degradation of insulation may be doubted when insulation resistances become lower at higher applied voltages.

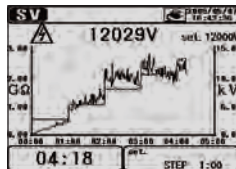

## RAMP RAMP TEST

Voltage used in Step voltage test is raised in steps but that used in Ramp measurement is gradually raised.

The KEW 3127 Ramp test generates a rising voltage ramp up to the selected voltage.

### [Breakdown Mode]

KEW 3127 automatically stops the test if the insulation breaks down in order to prevent damage to the object being tested.

### [Burn Mode]

KEW 3127 allows the insulation test voltage to continue even after the insulation breaks down. This enables you to locate a fault, such as pinholes in windings, by seeing a spark or a wisp of smoke.



## Data Communication Function

- Transferring and showing real-time data to PC and Android tablet
- Recorded data can be transferred (PC only)
- Analyzing of the saved data (PC only)



※Free Android software is available on download site

## Optional Accessories



### System requirements

OS: Windows®Vista/7(32/64bit)/8(32/64bit)  
Display: XGA (Resolution 1024 x 768 dots) or more  
Hard-disk: Space required 100Mbyte or more  
Others: With CD-ROM drive and USB port

\* Windows® is a registered trademark of Microsoft in the United States.



# HIGH VOLTAGE INSULATION TESTERS

10000V

KEW **3123A**



	3123A	
Test voltage	5000V	10000V
Measuring ranges (automatic change)	5GΩ/200GΩ (autoranging)	10GΩ/400GΩ (autoranging)
First effective measuring ranges	0.2 - 100GΩ	0.4 - 200GΩ
Accuracy	±5% rdg	
Other ranges accuracy	±10% rdg or 0.5% of scale length	
Power source	R6(AA)(1.5V) × 8	
Dimensions	200(L) × 140(W) × 80(D)mm	
Weight	1kg approx.	
Accessories	7165A(Line probe)(3m), 7224A(Earth cord)(1.5m), 7225A(Guard cord)(1.5m), 8019(Hook type prod), 9158(Carrying case [Hard]), R6(AA) × 8, Instruction manual	
Optional	7253(Longer line probe with alligator clip)(15m), 7168A(Line probe with alligator clip)(3m), 8324(Adaptor for recorder)	

- Rugged design with a hard carrying case for field use.
- Detachable High Voltage Line probe.
- Automatic ranges, high and low scales, indicated by different LEDs.
- Drip proof.
- Auto-discharge function.

## Accessories



**MODEL 7165A**  
line probe 3,000mm



**MODEL 7224A**  
Earth cord 1,500mm



**MODEL 7225A**  
Guard cord 1,500mm



**MODEL 8019**  
Hook type prod



**MODEL 9158**  
Carrying case [Hard]

## Optional Accessories



**MODEL 7168A**  
Line probe with alligator clip:3m



**MODEL 7253**  
Longer line probe with alligator clip:15m



**MODEL 8324**  
Adaptor for recorder (Output 10mV/1μA)  
Cable length:  
200mm connector side  
1100mm alligator clip side

## Use of Guard Terminal

Illustrated in this Fig. is an example of the insulation resistance measurement of an electric wire. If the line probe is simply connected to the wire conductor and the earth lead to the immersion liquid container as shown, a measurement error will be introduced as this results in the measurement of the combined resistance of insulation resistance and the surface leakage resistance at the cut end of the electric wire. In order to remove this surface leakage current, wind a guard wire around the cut end of the conductor and connect it to the guard terminal of the instrument using the guard lead. Then, the surface leakage current will bypass the indicating meter of the insulation resistance tester.

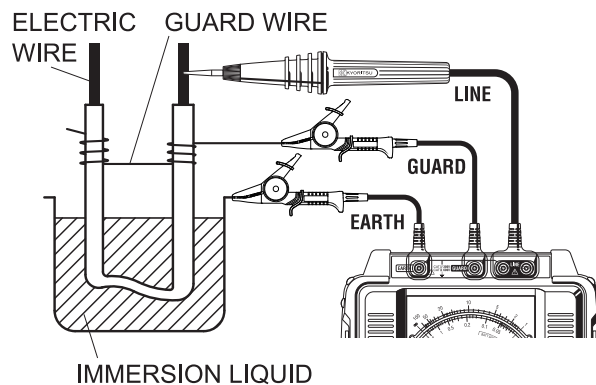

# HIGH VOLTAGE INSULATION TESTERS

10000V

## MODEL 3124



	3124	
Test voltage	1k - 10kV variable	1000V
Measuring ranges (automatic change)	1.6GΩ/100GΩ (autorange)	100MΩ
First effective measuring ranges	0.05 - 50GΩ	1 - 100MΩ
Accuracy	±10% rdg	
Other ranges accuracy	±1% of scale length	
Output voltage and set voltage indicate	DC 0 - 10kV ±2%rdg±2dgt	
Power source	Ni-Cd rechargeable battery(1.2V) × 8	
Dimensions	200(L) × 140(W) × 80(D)mm	
Weight	1.5kg approx.	
Accessories	7082(Lead for recorder), 7083(Lead for battery charging), 7084(Earth and guard leads), 9176(Carrying case[Hard]), 8075(Battery charger[120V]) or 8080(Battery charger[220V]), Ni-Cd rechargeable battery × 8, Instruction manual	

- Permits a wide range of insulation testing up to 100GΩ at variable test voltage from 1kV to 10kV.
- DC voltage output for recorders.
- Output voltage is shown on the digital display.
- After tests, automatically discharges the charges stored in the circuit under test.
- Operated by rechargeable Nickel-Cadmium batteries.

## Accessories

**MODEL 7082**  
Lead for recorder : 1,100mm



**MODEL 7083**  
Lead for Battery charging : 5,200mm



**MODEL 7084**  
Earth and guard leads : 5,000mm



### Battery charger

**MODEL 8075**  
120V



OR

**MODEL 8080**  
220V



**MODEL 9176**  
Carrying case[Hard]



## Instrument Layout

- |  |                                |
|--|--------------------------------|
| ① Line Probe                               | ⑬ Output Terminal for Recorder |
| ② Guard Terminal                           | ⑭ Pressto Test Buton           |
| ③ Earth Terminal                           | ⑮ Function Switch              |
| ④ Batery Alarm                             | ⑯ Output Voltage Set Knob      |
| ⑤ Batery Charging Indicator                |                                |
| ⑥ High Scale for 100GΩ Range               |                                |
| ⑦ Low Scale for 100GΩ Range                |                                |
| ⑧ High Scale Indicator for 100GΩ Range     |                                |
| ⑨ Low scale Indicator for 100GΩ Range      |                                |
| ⑩ Output Voltage and Set Voltage Indicator |                                |
| ⑪ Meter Movement Zero Adjust               |                                |
| ⑫ Terminal for Batery Charging             |                                |

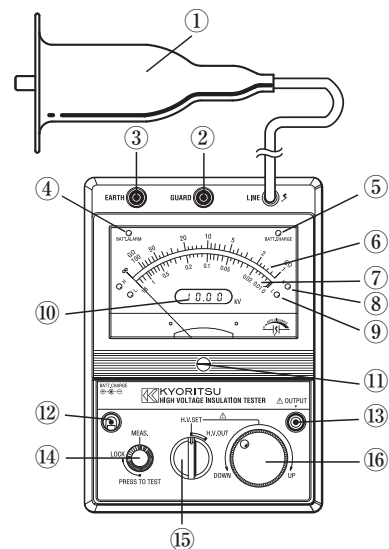

# HIGH VOLTAGE INSULATION TESTERS

2500V

5000V

KEW **3121B/3122B**

**NEW**

CAT. IV 300V CAT. III 600V

- Easy and simple operation.
- Automatic ranges, indicated by different LED's.
- Newly-designed alligator clip.
- It comes with a tough hard case.
- Safety standard IEC 61010-1 CAT IV 300V



photo : 3121B



photo : 3122B

CE

	3121B	3122B
Test voltage	2500V	5000V
Measuring ranges (automatic change)	2GΩ/100GΩ (auto ranging)	5GΩ/200GΩ (auto ranging)
First effective measuring ranges	0.1 - 50GΩ	0.2 - 100GΩ
Accuracy	±5% rdg	
Other ranges accuracy	±10% rdg or 0.5% of scale length	
Short circuit current	0.08mA	
Applicable standards	IEC 61010-1, 61010-2-030 CAT IV 300V, CAT III 600V Pollution degree 2, IEC 61326-1, 61326-2-2(EMC), IEC 60529(IP40)	
Power source	DC12V:LR14 × 8	
Dimensions	177(L) x 226(W) x 100(D) mm	
Weight	1.6kg approx.	1.7kg approx.
Accessories	7165A(Line probe)(3m), 7264(Earth cord)(3m), 7265(Guard cord)(3m), 8019(Hook type prod), 9182(Carrying case[Hard]), LR14 x 8, Instruction manual	7165A(Line probe)(3m), 7264(Earth cord)(3m), 7265(Guard cord)(3m), 8019(Hook type prod), 9183(Carrying case[Hard]), LR14 x 8, Instruction manual
Optional	7168A(Line probe with alligator clip)(3m), 7253(Longer line probe with alligator clip)(15m), 8302(Adaptor for recorder)	

## Optional Accessories

**MODEL 7168A**  
Line probe with alligator clip : 3000mm

**MODEL 7253**  
Longer line probe with alligator clip:15m

**MODEL 8302**  
Adaptor for recorder (Output 10mV/1μA)  
Cable length : 200mm  
Alligator clip side : 1100mm



# HIGH VOLTAGE INSULATION TESTERS

2500V 5000V 5000V  
**KEW 3025A/3125A** **NEW** **KEW 3126**



photo : 3125A



photo : 3025A



photo : 3126

CAT IV 300V CAT III 600V DC AC V AUTO POWER OFF

- Short-Circuit Current up to 5mA to Speed up tests.(KEW3126)
- Large digital display with Bar Graph indication and back light.
- Polarization Index measurement(PI)
- Dielectric Absorption Ratio(DAR).
- Indication of Output voltage and Discharge voltage.
- Safety standard IEC 61010-1 CAT IV 300V / CAT III 600V



3025A/3125A						
Range	Insulation resistance					Voltage measurement
Test voltage	250V	500V	1000V	2500V	5000V*1	
Measuring range	0.0 - 100.0MΩ	0.0 - 99.9MΩ 80 - 1000MΩ	0.0 - 99.9MΩ 80 - 999MΩ 0.80 - 2.00GΩ	0.0 - 99.9MΩ 80 - 999MΩ 0.80 - 9.99GΩ 8.0 - 100.0GΩ	0.0 - 99.9MΩ 80 - 999MΩ 0.80 - 9.99GΩ 8.0 - 99.9GΩ 80 - 1000GΩ	30 - 600V AC/DC (50/60Hz)
Accuracy	±5%rdg±3dgt	±5%rdg±3dgt	±5%rdg±3dgt	±5%rdg±3dgt	±5%rdg±3dgt ±20%(100GΩ or more)	±2%rdg±3dgt
Short circuit current	1.5mA					—
Rated test current	0.7mA - 0.9mA at 0.25MΩ load	0.8mA - 1mA at 0.5MΩ load	1mA - 1.2mA at 1MΩ load	1mA - 1.2mA at 2.5MΩ load	1mA - 1.2mA at 5MΩ load	—
Open circuit voltage	250V +10%, -10%	500V +20%, -10%	1000V +20%, -0%	2500V +20%, -0%	5000V +20%, -0%	—
Applicable standard	IEC 61010-1, 61010-2-030 CAT IV 300V, CAT III 600V Pollution degree 2, IEC 61326-1, 2-2					
Power source	DC12V:LR14 x 8					
Dimensions	177(L) x 226(W) x 100(D) mm					
Weight	1.7kg approx. : 3025A 1.9kg approx. : 3125A					
Accessories	7165A(Line probe)(3m), 7264(Earth cord)(3m), 7265(Guard cord)(3m), 8019(Hook type prod), 9180(Carrying case for 3025A) 9181(Carrying case for 3125A), LR14(Alkaline battery size C) x 8, Instruction manual					
Optional	7168A(Line probe with alligator clip)(3m), 7253(Longer line probe with alligator clip)(15m), 8302(Adaptor for recorder)					

\*1) KEW3125A only

3126					
Range	Insulation resistance				Voltage measurement
Test voltage	500V	1000V	2500V	5000V	
Measuring range	0.0 - 99.9MΩ 100 - 999MΩ	0.0 - 99.9MΩ 100 - 999MΩ 1.00 - 1.99GΩ	0.0 - 99.9MΩ 100 - 999MΩ 1.00 - 9.99GΩ 10.0 - 99.9GΩ	0.0 - 99.9MΩ 100 - 999MΩ 1.00 - 9.99GΩ 10.0 - 99.9GΩ 100 - 1000GΩ(1TΩ)	30 - 600V AC/DC (50/60Hz)
Accuracy	±5%rdg±3dgt	±5%rdg±3dgt	±5%rdg±3dgt	±5%rdg±3dgt ±20%(100GΩ or more)	±2%rdg±3dgt
Short circuit current	5.0mA				—
Rated test current	1mA - 1.2mA at 0.5MΩ load	1mA - 1.2mA at 1MΩ load	1mA - 1.2mA at 2.5MΩ load	1mA - 1.2mA at 5MΩ load	—
Open circuit voltage	500VDC+30%, -0%	1000VDC+20%, -0%	2500VDC+20%, -0%	5000VDC+20%, -0%	—
Maximum display	999 Counts(1000 counts only at 1000GΩ)				630 Counts
Current consumption	About 1000mA(During measurement)				110mA approx.
Applicable standard	IEC 61010-1 CAT III 600V Pollution degree 2, IEC 61326				
Power source	DC12V:LR14 x 8				
Dimensions	205(L) x 152(W) x 94(D) mm				
Weight	1.8kg approx.				
Accessories	7165A(Line probe)(3m), 7224A(Earth cord)(1.5m), 7225A(Guard cord)(1.5m), 8019(Hook type prod), 9159(Carrying case [Hard]), LR14(Alkaline battery size C) x 8, Instruction manual				
Optional	7168A(Line probe with alligator clip)(3m), 7253(Longer line probe with alligator clip)(15m), 8302(Adaptor for recorder)				

# EARTH TESTERS

## Measurement of the earth electrode resistance (3-Pole method)

[MODEL 4102A/KEW 4105A]

The international standard IEC 60364-6 provides information regarding the measurement of the resistance of an earth electrode for TT, TN and IT systems. This measurement shall be made by the Volt-Amperometric method using two auxiliary earth electrodes. The instrument that covers this requirement is the Earth Tester.

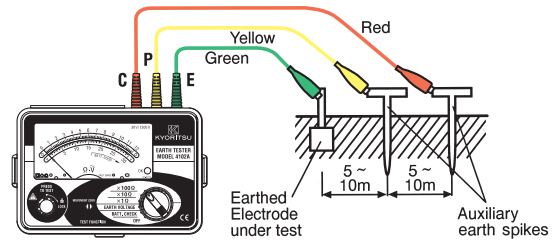

Precise Measurement (with Test lead M-7095A)

## Measurement of the simplified earth resistance (2-Pole method)

[KEW 4300/MODEL 4102A/KEW 4105A]

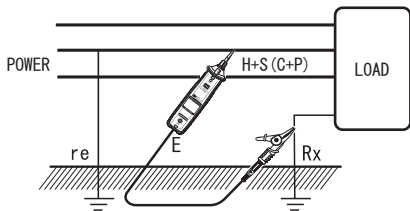

Measuring the earth resistance of load

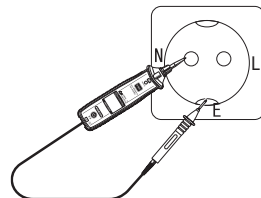

Measuring the earth resistance of wall socket

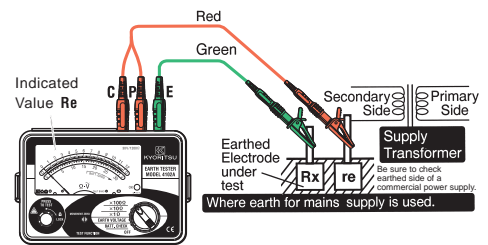

Simplified Measurement (with Test lead M-7127A)

## Measurement of the earth resistance with Earth Clamp (Why earth measurements can be found by only clamping it?)

[MODEL 4200/KEW 4202]

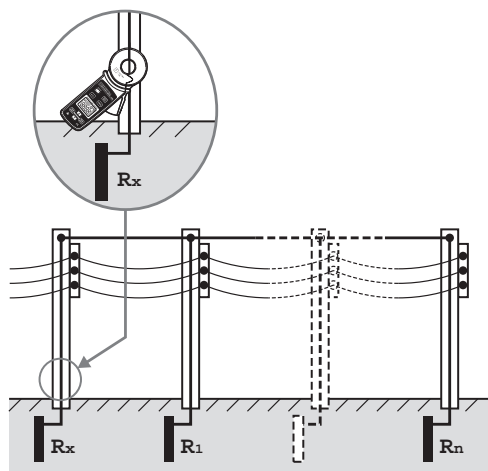

R<sub>x</sub> is defined as earth resistance under test, and R<sub>1</sub>, R<sub>2</sub>...R<sub>n</sub> are defined as earth resistance of other measuring objects.

These earth resistances, R<sub>1</sub>, R<sub>2</sub>, ... R<sub>n</sub> can be considered that they are connected in parallel. And They can be regarded as a combined resistance R<sub>s</sub>. The R<sub>s</sub> can be regarded small enough against R<sub>x</sub> since a combined resistance consists of several resistances.

Following is an equivalent circuit diagram of this circuit.

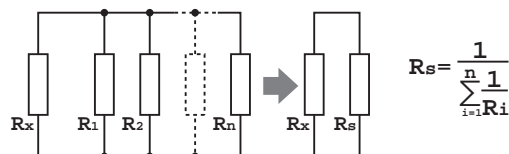

Voltage V is applied to the object (Resistance R<sub>x</sub>) measured from the voltage injection transformer CT1, and the current I corresponding to the earth resistance is flowed.

The current I is detected with detection transformer CT2, and object (Resistance R<sub>x</sub>) measured can be put out by the calculation. (refer to the right diagram)

$$\frac{V}{I} = R = R_x + R_s$$

$$R_x \gg R_s = \frac{1}{\sum_{i=1}^n \frac{1}{R_i}}$$

$$\frac{V}{I} = R_x$$

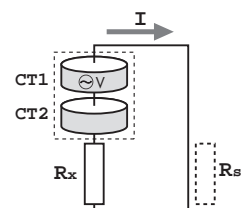

# EARTH TESTERS

## MODEL 4102A



CE

	4102A/4102A-H
Measurement ranges	Earth resistance : 0 - 12Ω / 0 - 120Ω / 0 - 1200Ω Earth voltage[50,60Hz] : 0 - 30V AC
Accuracy	Earth resistance: ±3% of full scale Earth voltage: ±3% of full scale
Overload protection	Earth resistance : 276V AC for 10 seconds across 2 of the 3 terminals Earth voltage : 276V AC for 1 minute
Applicable standards	IEC 61010-1 CAT III 300V Pollution degree 2 IEC 61557-1,5 IEC 60529(IP54)
Power source	R6(AA)(1.5V) × 6
Dimensions	105(L) × 158(W) × 70(D)mm
Weight	600g approx.
Accessories	7095A(Earth resistance test leads) × 1set(red-20m, yellow-10m, green-5m) 8032(Auxiliary earth spikes[2 spikes/set]) × 1set 7127A(Simplified measurement probe) × 1set R6(AA) × 6, 9121(Shoulder strap), Instruction manual Carrying case : 9084(Carrying case[Soft]) : 9164(Carrying case[Hard])
Optional	7100A(Precision measurement cord set)

MODEL 4102A Soft case model

MODEL 4102A-H Hard case model

## KEW 4105A



CE

	4105A/4105A-H
Measurement ranges	Earth resistance : 0 - 20Ω / 0 - 200Ω / 0 - 2000Ω Earth voltage[50,60Hz] : 0 - 200V AC
Accuracy	Earth resistance : ±2%rdg±0.1Ω(20Ω range) ±2%rdg±3dgt(200/2000Ω range) Earth voltage : ±1%rdg±4dgt
Overload protection	Earth resistance : 280V AC for 10 seconds across 2 of the 3 terminals Earth voltage : 300V AC for 1 minute
Applicable standards	IEC 61010-1 CAT III 300V Pollution degree 2 IEC 61557-1,5 IEC 60529(IP54)
Power source	R6(AA)(1.5V) × 6
Dimensions	105(L) × 158(W) × 70(D)mm
Weight	550g approx.
Accessories	7095A(Earth resistance test leads) × 1set(red-20m, yellow-10m, green-5m) 8032(Auxiliary earth spikes[2 spikes/set]) × 1set 7127A(Simplified measurement probe) × 1set R6(AA) × 6, 9121(Shoulder strap), Instruction manual Carrying case : 9084(Carrying case[Soft]) : 9165(Carrying case[Hard])
Optional	7100A(Precision measurement cord set)

KEW 4105A Soft case model

KEW 4105A-H Hard case model

- In addition to the facility for precision measurement, test leads for simplified two wire measuring system also supplied as standard accessories. (unit can be hung from the neck for simplified measurement)
- The latest circuit design permits the instrument to operate with the minimum of influence from earth voltage and earth resistance of auxiliary earth spikes.
- Dust and drip proof. (designed to IEC 60529 IP54)
- Earth resistance value can be read directly from the scale.
- Designed to meet IEC 61010-1 safety standard.
- Capable of measuring earth voltage.
- Small and lightweight. Shock resistant new case material.
- 2mA measuring current permits earth resistance tests without tripping earth leakage current breakers in the circuit under test.
- Lead wire connection to C and P terminals and proper auxiliary earth resistance can be checked by "OK" lamp. Lead wire connection to C and E terminals is good when "OK" lamp is illuminated. (4102A)



Soft case model



Hard case model

## Optional Accessories

### MODEL 7100A

Precision measurement cord set  
(7095A, 8032, 8200-03, 9091)

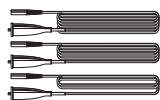

### MODEL 7095A

Test leads for earth resistance



### MODEL 8032

Auxiliary earth spikes  
[2 spikes/1set]



### MODEL 8200-03

Cord reels[3 pcs]

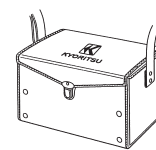

### MODEL 9091

Carrying case for cord reels



# EARTH TESTERS



## KEW 4106



- Earth resistance measurement with six ranges covering measurements from 0.001 Ω to 200 kΩ.
- Earth resistivity (ρ) measurement is automatically calculated after having set the distance between Auxiliary Earth Spikes (Wenner method).
- Automatic and Manual selection of the Test Current Frequency in four bands of 94/105/111/128Hz. In Automatic mode KEW 4106 will select the most suitable Frequency.
- Advanced Filtering method (based on FFT Fast Fourier Transform) reduces noise interference for obtaining stable measurements.
- Up to 800 measurement results can be saved in the memory and recalled on the display.
- The stored results can be transferred to a PC via USB adaptor (Model 8212-USB) by using software "KEW Report" which are included.
- Robust design with IP54 protection.

		4106			
Function	Range	Resolution	Measuring range	Accuracy	
Earth resistance Re (Rg at ρ measurement)	2Ω	0.001Ω	0.03 - 2.099Ω	±2%rdg.±0.03Ω	
	20Ω	0.01Ω	0.03 - 20.99Ω		
	200Ω	0.1Ω	0.3 - 209.9Ω		
	2000Ω	1Ω	3 - 2099Ω	±2%rdg.±5dgt	
	20kΩ 200kΩ	10Ω 100Ω	0.03k - 20.99kΩ 0.3k - 209.9kΩ		
Auxiliary earth resistance Rh, Rs				8% of Re+Rh+Rs	
Earth resistivity ρ	2Ω	0.1Ω·m - 1Ω·m Autoranging	0.2 - 395.6Ω·m	ρ=2×π×a×Rg	
	20Ω		0.2 - 3956Ω·m		
	200Ω		20 - 39.56kΩ·m		
	2000Ω		0.2 - 395.6kΩ·m		
	20kΩ 200kΩ		2.0 - 1999kΩ·m		
	Series interference voltage Ust (A.C only)		50V		0.1V
Frequency Fst	Autoranging	0.1Hz, 1Hz	40Hz - 500Hz	±1%±2dgt	
Test Current	80mA(max)				
Memory capacity	800 data				
Communication interface	Model 8212-USB Optical Adaptor				
LCD	Dot-matrix 192 × 64, monochrome				
Over-range indication	"OL"				
Overload protection	between E-S(P) and between E-H(C) terminals AC280V / 10 sec				
Applicable standards	IEC 61010-1 CAT III 300V, CAT IV 150V Pollution degree 2 IEC 61557-1,5, IEC 61326-1(EMC), IEC 60529(IP54)				
Power source	DC12V : sizeAA manganese dry battery (R6) x 8 (Auto power off: approx. 5 minutes)				
Dimensions	167(L) × 185(W) × 89(D)mm				
Weight	approx. 900g (including batteries)				
Accessories	7229A(Earth resistance test leads), 7238A(Simplified measurement test leads) 8032(Auxiliary earth spikes[2spikes/set])×2, 8200-04(Cord reels [4pcs]), 8212-USB(USB adaptor with "KEW Report(Software)") 9121(Shoulder strap), 9125(Carrying case) R6×8, Instruction manual				
Optional	8212-RS232C(RS232C adaptor with "KEW Report(Software)")				



## KEW 4300

### SIMPLIFIED EARTH TESTER



		4300
Earth resistance ranges	200.0/2000Ω(Auto ranging)	±3%rdg±5dgt
Voltage ranges	AC:5.0 - 300.0V(45 - 65Hz) ±1%rdg±4dgt DC:±5.0 - 300.0V ±1%rdg±8dgt	
Applicable standards	IEC 61010-1 CAT III 300V pollution degree 2 IEC 61557-1,-5 IEC 61326-1,2-2,IEC 60529(IP40)	
Power source	Size AA alkaline battery x 2 pcs	
Dimensions	232(L) x 51(W) x 42(D)mm	
Weight	220g approx(including battery)	
Accessories	7248(Test lead with Alligator clip and Flat test probe) 8072(CAT II Standard prod) 8253(CAT IV Standard prod) 8017(Extension prod long) 9161(Carrying case) Instruction manual, LR6(AA)×2	

KEW4300 is simplified earth resistance tester (based on 2-pole method) that can be used for various distribution lines and electrical appliances and it also can measure AC/DC voltage. (As for AC voltages, true rms values can be obtained.)

- 200/2000Ω (2 ranges) : auto-ranging.
- Warning buzzer triggered at 100Ω or less.
- LED lights up when a large earth voltage is detected.
- Live circuit warning when 30V or higher voltage is detected. (KEW4300 detects voltage even when measuring resistances.)
- LED light for illuminating measurement points. (It turns on/off automatically in relation to the ambient brightness.)
- Small test current (max 2mA) not triggering RCD.

# EARTH CLAMP TESTERS

## MODEL 4200/KEW 4202



photo : 4202



	4200	4202
Earth resistance Auto range	20.00/200.0/1500Ω ±1.5%±0.05Ω(0.00 - 20.99Ω)* ±2%±0.5Ω(16.0 - 99.9Ω) ±3%±2Ω(100.0 - 209.9Ω) ±5%±5Ω(160 - 399Ω) ±10%±10Ω(400 - 599Ω)	
AC current (50Hz/60Hz) Auto range	Values are displayed, but accuracy isn't guaranteed(600 - 1580Ω) 100.0/1000mA/10.00/30.0A ±2%±0.7mA(0.0 - 104.9mA) ±2%(80mA - 31.5A)	
Operating indication	Earth resistance function : Constant voltage injection Current detection (Frequency : Approx.2400Hz) Dual Integration AC current function : Successive approximation	
Over-range indication	"OL" is displayed when input exceeds the upper limit of a measuring range	
Response time	Approx. 7 seconds (Earth resistance) Approx. 2 seconds (AC current)	
Sample rate	Approx. 1 times per second	
Communication Interface	—	Bluetooth Ver2.1 + EDR Class2
Power source	DC6V : R6(sizeAA manganese battery) x 4 or LR6 (sizeAA alkaline battery) x 4	
Current consumption	Approx. 50mA (max.100mA)	Approx. 50mA (max.100mA)
Measurement time	Approx.12 hours (when R6 is used) Approx.24 hours (when LR6 is used)	Approx.5 hours (when R6 is used) Approx.21 hours (when LR6 is used)
Auto power-off	Turns power off about 10 minutes after the last button operation.	
Applicable standards	IEC 61010-1 CAT IV 300V Pollution degree2 IEC 61010-2-032, IEC 61326 (EMC)	
Conductor size	Approx. φ32mm	
Dimension	246(L)×120(W)×54(D)mm	
Weight	Approx. 780g (including batteries)	
Accessories	R6 x 4, Instruction manual 8304 (Resistor for operation check) 9166 (Carrying case[Hard])	LR6 x 4, Instruction manual 8304 (Resistor for operation check) 9167 (Carrying case[Hard])



Note: A single earthing can not be measured. (Only for Multiple Earthing system)

- The earth resistance from 0.05 to 1500Ω can be measured without the auxiliary earth spikes in multi-earthing systems
- True RMS leakage or phase current readings from 0.1mA to 30.0A provides vital additional information in earthing networks
- Filter function offers increased immunity to electrical noise and a Noise mark appears in excessively high noisy environments
- Memory function up to 100 data
- Bluetooth communication (4202 only)

\*Crest factor ≤ 2.5 (50Hz/60Hz, peak value shall not exceed 60A)  
\*4 counts or less are corrected to 0.

Various useful functions are available on Android devices using Bluetooth communication(4202 only)

Free Android software "KEW Smart 4202" is available on download site

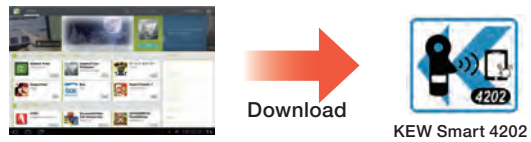

※Communication charges may be incurred separately to download application

Recorded data can be transferred (up to 100 measurements)

Measurement results

Measured data with time and location info can be sent by E-mail

E-mail

GPS data collection may be lost since the GPS signal differs depending on the location of satellites.  
To access GPS data and send emails, an Internet connection is required.  
Communication charges may be incurred separately for using these functions.

Comparator function informs when the measured value is lower/higher than the preset value

Beep! Beep!

## Accessories



※Available on the Android devices equipped with Bluetooth/ GPS/ Data communication function Supporting Android ver. 2.2 - 4.4  
Max communication distance :10m  
Bluetooth is a registered trademark of the Bluetooth SIG, Inc.  
Android is a registered trademark of the Google Inc.

## Earth Clamp Line up

	4200	4202
Comon functions	Earth resistance, AC current, Back light function, Data hold function, Auto power off, Memory function	
Individual functions	—	Bluetooth communication

# LOOP/PSC TESTERS

## MODEL 4118A



CE

- Custom microprocessor controlled for highest accuracy and reliability.
- 3 LEDs for checking correct wiring status.
- 15mA LOOP measurement: LOOP impedance 2000Ω range measurement is carried out with low test current (15mA). The current will not cause tripping out involved RCD even the one with the lowest nominal differential current (30mA).
- Direct reading of Prospective Short Circuit Current (PSC).
- Measure low loop resistances (resolution of 0.01Ω)
- Automatic lock-out if test resistor overheats.
- Large custom digital display readout .
- Visual indication of reversed phase and neutral wiring at socket.
- Designed to IP54 Rating

	4118A
Loop impedance ranges	20/200/2000Ω
Loop impedance accuracy	±2%rdg±4dgt
AC test current	20Ω 25A 200Ω 2.3A 2000Ω 15mA
AC test period	20Ω (20ms) 200Ω (40ms) 2000Ω (280ms)
PSC ranges	200A(2.3A 40ms) 2000A(25A 20ms) 20kA(25A 20ms)
PSC ranges accuracy	Consider accuracy of loop impedance
Voltage	110V - 260V ±2%rdg±4dgt
Operating voltage	230V +10%, -15%(195V - 253V)50Hz
Applicable standards	IEC 61010-1 CAT III 300V Pollution degree 2 IEC 61557-1,3, IEC 60529(IP54)
Dimensions	167(L) × 185(W) × 89(D)mm
Weight	750g approx.
Accessories	Molded plug test leads* 7121B(Distribution board test leads) 9147(Cord case) 9121(Shoulder strap) Instruction manual

\* 7123(AU): Australian plug      7124(UK): British plug(13A)  
7125(EU): European SHUKO plug      7126(SA): South african plug

## Accessories



MODEL 7121B  
(Distribution board test leads)



### Molded plug test leads

- MODEL 7123 (AU) Australian plug
- MODEL 7124 (UK) British plug(13A)
- MODEL 7125 (EU) European SHUKO plug
- MODEL 7126 (SA) South african plug

## Loop Testing Methods

In the buildings mainly used for private residence where low voltage power is supplied from electric utilities the fundamental protection against electric shock hazards is provided by appropriately coordinating the function of an earthing circuit with automatic switches placed at the latter stage of indoor wiring circuits. This is intended to quickly cut off the supply to an earthing circuit where a fault occurs following touch voltage exceeding an acceptable limit. Proper protection against electric shock hazards is given when the TT wiring system satisfies the requirement as expressed by the following formula:

$$R_a \times I_a \leq 50$$

where  $R_a$  is the sum of the resistances of earth bars and protective conductors and  $I_a$  is the maximum current of a protection system provided for installations, indicating that the value obtained by multiplying  $R_a$  with  $I_a$  is not more than 50V. This means a maximum voltage one can touch shall not exceed 50V in the event of an earth fault.

- Method of earth fault loop impedance testing at socket outlet. As shown in Fig., total earth fault loop impedance can be measured by plugging a loop tester into socket. The value of earth fault loop impedance measured represents the sum of transformer coil winding resistance, phase conductor (L3) resistance and protective conductor (PE) resistance as well as source earth resistance and installation earth resistance. With the loop tester set to any one of the PSC (prospective short circuit current) range, it is also possible to measure earth fault current.

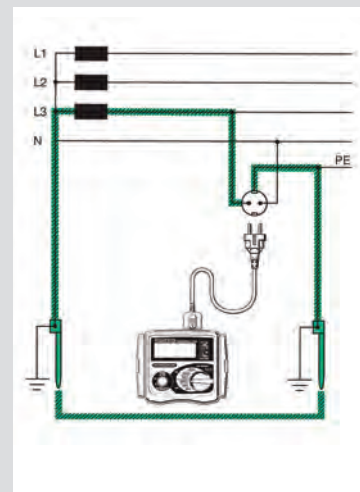

Fig. Earth fault loop impedance testing at socket outlet.



# LOOP/PSC TESTERS

## KEW 4140



- Anti-Trip Technology for complete trip free Loop testing on all RCDs rated 30mA and above.
- Dual Display allows simultaneous measurements like Loop & PFC/PSC.
- Two wire connection for Loop L-L, L-N and PSC testing is possible.
- Phase rotation, Voltage and Frequency measurements.
- Lock-down test button for 'hands free' testing with auto-start operation.
- Display and front panel keyboards with Backlight to be visible in dark places.
- Water and Dust proof (IP54)



4140			
<b>Loop Impedance</b>			
Function	L-PE ATT OFF	L-PE ATT ON	L-N/L-L
Rated voltage	230V (50/60Hz)		L-N: 230V (50/60Hz) L-L: 400V (50/60Hz)
Operating Voltage	100 - 280V (45 - 65Hz)		100 - 500V (45 - 65Hz)
Range (Auto-Ranging)	20/200/2000Ω	20/200/2000Ω (L-N<20Ω)	20Ω
Nominal Test Current at 0Ω External Loop: Magnitude/Duration at 230V	20Ω:6A/40ms 200Ω:2A/20ms 2000Ω:15mA/500ms	L-N:6A/60ms N-PE:10mA/approx. 5s	20Ω:6A/20ms
Accuracy	±3%rdg±4dgt (*1)	±3%rdg±6dgt (*1)	L-N: ±3%rdg±4dgt L-L: ±3%rdg±8dgt
<b>PFC(L-PE)/PSC(L-N/L-L) (*2)</b>			
Function	PSC	PFC (ATT)	PSC
Rated voltage	230V (50/60Hz)		L-N: 230V (50/60Hz) L-L: 400V (50/60Hz)
Operating Voltage	100 - 280V(45 - 65Hz)		100 - 500V(45 - 65Hz)
Range (Auto-Ranging)	2000A/20kA	2000A/20kA(L-N<20Ω)	2000A/20kA
Nominal Test Current at 0Ω External Loop: Magnitude/Duration at 230V	20Ω:6A/40ms 200Ω:2A/20ms 2000Ω:15mA/500ms	L-N:6A/60ms N-PE:10mA/approx. 5s	20Ω: 6A/20ms
<b>Phase Rotation</b>			
Operating Voltage	50 - 500V, 45 - 65Hz		
Remarks	Correct phase sequence : displayed "1.2.3" and ⚙ mark Reversed phase sequence : displayed "3.2.1" and ⚙ mark		
<b>Volts</b>			
Function	Volts		Frequency
Measuring range	0 - 500V		45 - 65Hz
Accuracy	±2%rdg±4dgt		±0.5%rdg±2dgt
Applicable standards	IEC 61010-1 CAT III 300V (500V L to L) IEC 61557-1,3,7,10, IEC 60529 (IP54), IEC 61326(EMC)		
Power source	1.5V AA batteries × 6 *Use of alkaline batteries (LR6) is recommended.		
Dimensions	84(L) × 184(W) × 133(D)mm		
Weight	860g (including batteries.)		
Accessories included	Main test lead (*3), Distribution board test lead (*4), 9155 (shoulder strap), 9156 (Soft case) LR6 (Battery) × 6, Instruction manual		

\*1: Accuracy of L-N LOOP displayed on the Sub Display is synchronized with the one at L-N/L-L function.

\*2: PSC/PFC Accuracy is derived from measured loop impedance specification and measured voltage specification.

\*3: 7187A:(UK)British plug, 7218A:(EU)European SHUKO plug, 7221A:(SA)South african plug, 7222A: (AU)Australian plug

\*4: 7246 : Blue, Green, Red, 7247 : Black, Green, Red

## Accessories



**Main test lead**

**MODEL 7187A**

**MODEL 7218A** (EU)European SHUKO plug

**MODEL 7221A** (SA)South african plug

**MODEL 7222A** (AU)Australian plug



**Distribution board test lead**

**MODEL 7246** Blue, Green, Red

**MODEL 7247** Black, Green, Red



**MODEL 9156**

Soft case

# RCD TESTERS

## MODEL 5406A



CE

	5406A
Rated tripping current	10/20/30/200/300/500mA
Fault condition settings	× 1/2 × 1 × 5 × DC Auto Ramp
Trip current duration	1000ms 200ms(× 5)
Lowest resolution	1ms
Trip time accuracy	±0.6%rdg±4dgt
Operating voltage	230V+10%-15% (195V - 253V)[50Hz]
Applicable standards	IEC 61557-1,6 IEC 61010-1 CAT III 300V IEC 61010-031 Pollution degree 2 IEC 60529(IP54)
Dimensions	167(L) × 186(W) × 89(D)mm
Weight	800g approx.
Accessories	Molded plug test leads* 9147(Cord case) 9121(Shoulder strap) Instruction manual
Optional	7121B(Distribution board test leads)

\* 7123(AU) : Australian plug 7124(UK) : British plug(13A)  
7125(EU) : European SHUKO plug 7126(SA) : South african plug

- Custom microprocessor controlled for highest accuracy and reliability.
- 3 LEDs for checking correct wiring status.
- 0 and 180 degree phase angle switch permits quick tests and consistent readings.
- Digital read-out of tripping time.
- Test of a large kind of RCDs : Standard, Selective, AC and A(DC sensitive breakers).
- Constant current source circuitry ensures that a fluctuating mains voltage does not affect the accuracy of readings.
- Large custom digital display readout .
- Visual indication of reversed phase and neutral wiring at socket.
- Designed to IP54 Rating.
- Complies with IEC 61557

## Accessories



### Molded plug test leads

**MODEL 7123** (AU)Australian plug

**MODEL 7124** (UK)British plug(13A)

**MODEL 7125** (EU)European SHUKO plug

**MODEL 7126** (SA)South african plug

# RCD TESTERS

KEW **5410**



- Measurement of RCD trip time**  
 Conducting testing of rated residual non-operating currents at x 1/2 Range, measuring RCD trip time at x1 and x5 Ranges.
- Measurement of trip out current**  
 Measuring trip out current by varying current automatically.
- Remote Test**  
 Enabling a user to hold the Test Leads with his both hands by locking the Test Button. Measurement will automatically start when the main voltage is detected.
- Voltage Measurement**  
 Carrying out a constant measurement of voltage in the stand-by mode at each Range.
- Auto-detection of Contact voltage**  
 Detecting the voltage to earth of Earth electrodes or Protective conductors during RCD test - when applying test currents - at measurement using EARTH in order to prevent electrical shocks caused by the damaged earth. Measurement will be ceased at AC50V or more.
- Dust- and Water-proof**  
 Dust- and Water-proof construction. (designed to IEC 60529 IP54)
- Backlight**  
 Facilitating working at dimly illuminated locations.

		5410			
Measurement of RCD trip time		Measurement of trip out current			
Range		x5	x1	x1/2	Auto Ramp (mA)
Rated voltage		100V±10% 200V+32%/-10% 400V±10% (50/60Hz)			
Test current		15/30/50/100mA	15/30/50/100/200/500mA	15/30/50/100/200/500mA	
Measuring range		Testing time 200ms	Testing time 2000ms	Testing time 2000ms	40% - 110% of IΔn (goes up by 5%) Testing time 300ms x 15 steps
Accuracy	Trip time	±1%rdg±3dgt	±1%rdg±3dgt	±1%rdg±3dgt	Test current at each step
	Test current	+2% - +8%dgt	+2% - +8%dgt	-8% - -2%dgt	-4% - +4%
Voltage measurement					
Measuring range	80V - 450V(50/60Hz)				
Accuracy	±2%rdg±4dgt				
Applicable standards	IEC 61010-1 Pollution degree 2 CAT III 300V/ CAT II 400V IEC 61557-1,6 IEC 60529(IP54)				
Display	1999 counts(3 1/2digits), Large LCD				
Operating temperature & humidity	0°C - 40°C, relative humidity 85%(no condensation)				
Storage temperature & humidity	-20°C - 60°C, relative humidity 85%(no condensation)				
Insulation resistance	50MΩ or more / 1000V(between electrical circuit and enclosure)				
Power source	DC12V / Size AA battery R6(SUM-3)×8pcs				
Dimension	167(L)×186(W)×89(D)mm				
Weight	Approx. 965g (including batteries)				
Accessories	7128A(Test leads) 7129A(Test lead with alligator clip) 8017(Extension prod)×2 9147(Cord case), 9121(Shoulder strap), Instruction manual, R6(SUM-3)(AA)×8				

\*Only the RCD type G (without trip out time-delay) can be tested at Auto Ramp Test ; type S (time-delay) cannot be tested.

## Accessories



**MODEL 7128A**  
Test leads



**MODEL 7129A**  
Test lead with alligator clip



**MODEL 8017**  
Extension prod

### Neutral - Line

Connect the "PRIMARY" of the Connector Block to the Neutral of the power of RCD, and the "SECONDARY" of the Connector Block to the Line of the load of RCD.

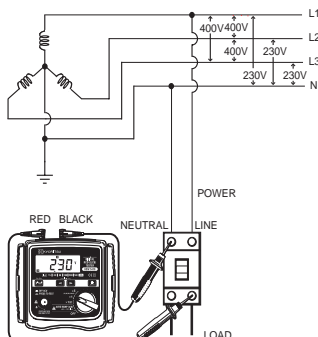

### Line - Line

Connect the "PRIMARY" of the Connector Block to L2 of the power of RCD, and the "SECONDARY" of the Connector Block to L1 of the load of RCD.

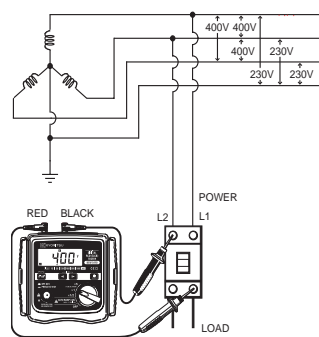

### Earth - Line

Connect the "PRIMARY" of the Connector Block to Earth, and the "SECONDARY" of the Connector Block to Line of the load of RCD.

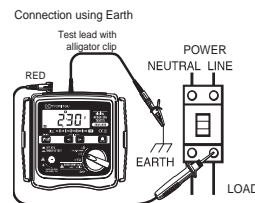



# PORTABLE APPLIANCE TESTERS

## KEW 6201A



The KEW 6201A is a portable appliance tester, performing four functions to ensure the Safety of Class I and Class II appliances. And also can measure the mains voltage.

Readings are displayed on a large liquid crystal display (LCD) below which are four LEDs which unambiguously display a pass or fail indication for threshold values dictated by AS/NZS 3760.

This instrument is suitable for performing tests as required by the following standards. AS/NZS 3760 In-service safety inspection and testing of electrical equipment.

		6201A
<b>RPE 20Ω Protective Conductor Resistance Test</b>		
Measuring range	0 - 15.00Ω	
Open circuit voltage	< AC 12V	
Measuring current	10A AC nominal value	
Accuracy	±3%rdg±5dgt	
<b>RINS 200MΩ Insulation Resistance</b>		
Rating	250V/20MΩ	500V/20MΩ
Measuring range	0 - 19.99MΩ	
Output Voltage	250V DC (+20%/-10%) @1MΩ	500V DC (+20%/-10%) @1MΩ
Short circuit current	2.5mA DC or less	
Accuracy	±2%rdg±3dgt	
<b>Leakage Current Test</b>		
Measuring range	AC 0.1 - 19.99mA	
Examination time	Max 15 seconds	
Accuracy	±3%rdg±5dgt	
<b>AC VOLT Mains Voltage Check</b>		
Measuring range	207 - 264V	
Accuracy	±2%rdg±3dgt	
Supply Voltage	240V±10%	
Frequency	50Hz±1%	
Applicable standards	IEC 61010-1 CAT III 300V Pollution Degree2, IEC 61326-1(EMC)	
Dimensions	167 (L) × 185 (W) × 89 (D) mm	
Weight	1.2kg (only the instrument body)	
Accessories	7123 (Power cord [AU]), 7129A (Test leads with Alligator clip), 7161A (Flat test prod), 7140 (Adapter for Extension Cord), 9147 (Cord case), 9121 (Shoulder strap) Instruction manual	
Optional	7121B (Distribution board test leads)	

## Test Function

Function	Tests of contents
Class I Test	<ul style="list-style-type: none"> <li>Protective conductor resistance</li> <li>Insulation (250V or 500V)</li> </ul>
SELECT Switch + Class I Test	<ul style="list-style-type: none"> <li>Protective conductor resistance</li> <li>Leakage Current test</li> </ul>
Class II Test	<ul style="list-style-type: none"> <li>Insulation (250V or 500V)</li> </ul>
SELECT Switch + Class II Test	<ul style="list-style-type: none"> <li>Leakage Current test</li> </ul>
Extension Leads test	<ul style="list-style-type: none"> <li>Protective conductor resistance</li> <li>Insulation P/N-PE</li> <li>Polarity</li> </ul>
SELECT Switch + Extension Leads test	<ul style="list-style-type: none"> <li>Protective conductor resistance</li> <li>Leakage Current test</li> </ul>
Leakage Current Test	<ul style="list-style-type: none"> <li>Leakage current measurement</li> </ul>

## Accessories



## Optional Accessories



# MULTI FUNCTION TESTERS

## MODEL 6018

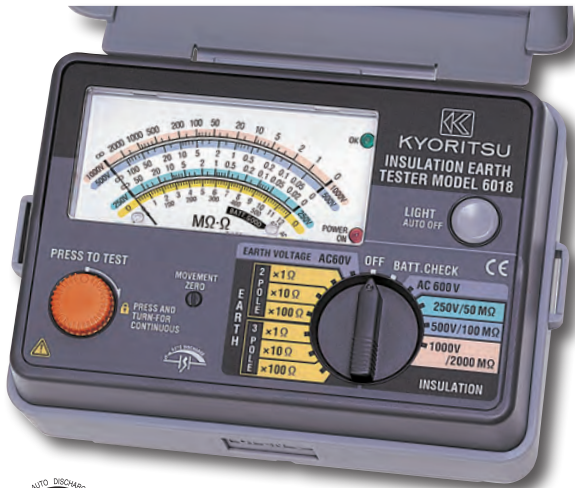

3 in 1

**Insulation**

250/500/1000V

**ACV**

600V

**Earth**

2/3 POLE 12/120/1200Ω

	6018
<b>Insulation testing</b>	
Test voltage	250V/50MΩ 500V/100MΩ 1000V/2000MΩ
Accuracy	±5%rdg
<b>Earth resistance</b>	
Simplified precision measurement	12Ω/120Ω/1200Ω
Accuracy	±3% of full scale value
<b>AC voltage</b>	
0 - 600V AC	±3% of full scale value
<b>Earth voltage</b>	
0 - 60V AC	±3% of full scale value
<b>General</b>	
Applicable standards	IEC 61010-1 CAT III 600V pollution degree 2 IEC 61010-031 IEC 61557
Power source	R6(AA)× 8
Dimensions	130(L) × 183(W) × 100(D)mm
Weight	1000g approx. (including batteries)
Accessories	7103A (Test leads with remote control switch) 7161A (Flat test prod) 7131B (Safety crocodile clips [black]) 8017 (Extension prod) 9092 (Cord case) 9121 (Shoulder strap) R6(AA)× 8 Instruction manual
Optional	7100A (Precision measurement cord set) 7115 (Extension probe) 8016 (Hook type prod)

## Accessories



**MODEL 7103A**

Test lead with remote control switch  
Line 1,000mm / Earth 1,550mm



**MODEL 7131B**

Safety crocodile clip



**MODEL 7161A**

Flat test prod



**MODEL 8017**

Extension prod

## Optional Accessories



**MODEL 7100A**

Precision measurement cord set  
(7095A, 8032, 8200-03, 9091)



**MODEL 7115**

Extension probe



**MODEL 8016**

Hook type prod

# MULTI FUNCTION TESTERS

## KEW 6010B



- Designed to IEC 61010-1, IEC 61557
- Data Memory : 300 measured results
- Download Results to PC by Using 8212 Data Communication Adaptor through Optical RS-232C Port.

### 5 in 1

#### Continuity

20/200Ω

#### Loop

20/2000Ω

#### Uc

100V

#### Insulation

500/1000V

#### RCD

10/30/100/300/500mA

## Accessories

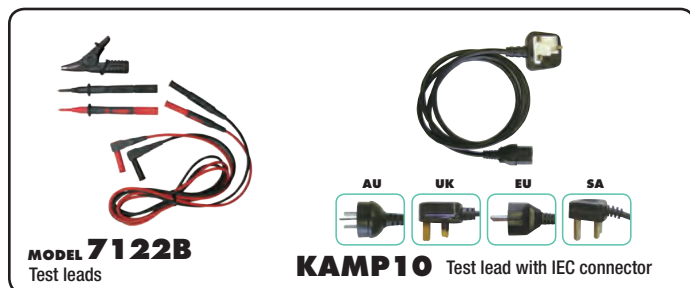

		6010B
<b>Continuity testing</b>		
Measuring range		20/200Ω (Auto-ranging)
Open circuit voltage		>6V
Short circuit current		>200mA
Accuracy		±(3%rdg+3dgt)
<b>Insulation resistance testing</b>		
Measuring range		20/200MΩ(Auto-ranging)
Test voltage		500/1000V
Open circuit voltage		+20%, -0%
Rated current		>1mA
Accuracy		±(3%rdg+3dgt)
<b>LOOP Impedance testing</b>		
Impedance range		20Ω/2000Ω
Rated voltage		230V +10%, -15% [50Hz]
Normal test current		20Ω: 25A/10ms 2000Ω: 15mA/350ms max.
Accuracy		±(3%rdg+8dgt)
<b>RCD testing</b>		
Test current (Test current duration)	×1/2, ×1	10, 30, 100, 300, 500mA (2000ms)
	FAST	150mA(50ms)
	DC	10,30,100,300mA (2000ms), 500mA(200ms)
	Auto ramp	Goes up by 10% from 20% to 110% of IΔn. 300ms × 10
Rated voltage		230V+10%, -15% 50Hz
Accuracy	Test current	× 1/2 : -8%, -2% × 1, Fast : +2%, +8%
	Trip time	DC : ±10% Auto ramp: ±4%
		±(1%rdg+3dgt)
<b>Uc testing</b>		
Measuring range		100V
Rated voltage		230V +10%, -15% [50Hz]
Test current		5mA at IΔn=10mA 15mA at IΔn=30/100mA 150mA at IΔn=300/500mA
Accuracy		+5%, +15%rdg ±8dgt
<b>General</b>		
Applicable standards		IEC 61010-1 CAT III 300V Pollution degree 2 IEC 61557-1,2,3,4,6,10, IEC 60529 (IP40)
Power source		R6 or LR6 × 8
Dimensions		175(L) × 115(W) × 86(D) mm
Weight		840g approx.
Accessories		7122B (Test leads) KAMP10 (Test lead with IEC connector)* 9092 (Cord case) 9148 (Shoulder strap) Shoulder pad Instruction manual R6(AA)× 8
Optional		7133B (Distribution board test leads) 8212-RS232C (RS232C adaptor with "KEW Report (Software)") 8212-USB (USB adaptor with "KEW Report (Software)")

\* KAMP10(EU):European SHUKO plug KAMP10(UK):British plug(13A)  
KAMP10 (AU):Australian plug KAMP10(SA):South african plug

## Optional Accessories

**MODEL 8212-USB**  
USB adaptor with "KEW Report (Software)"



**MODEL 8212-RS232C**  
RS232C adaptor with "KEW Report (Software)"



**MODEL 7133B** Distribution board test leads



### Specifications

	MODEL 8212-USB	MODEL 8212-RS232C
Communication method	USB Ver1.1	-
Driver type	Virtual COM port	-
Communication speed	19200bps max.	9600bps max.
Dimensions	Adaptor : 53(L)×36(W)×19(D)mm Cable : 2m approx.	Adaptor : 61(L)×36(W)×19(D)mm Cable : 1.6m approx.
Operating temperature and humidity	-10 - +50°C 85%RH or less with no condensation	0 - +40°C 85%RH or less with no condensation
Storage temperature and humidity	-20 - +60°C 85%RH or less with no condensation	

### System Requirements

OS: Windows® Vista/7(32/64bit)/8(32/64bit) Hard-disk: Space required 20Mbyte or more  
Display: XGA (Resolution 1024 x 768 dots) or more Others: With CD-ROM drive and USB port

\*Windows® is a registered trade mark of Microsoft in the United States.

"KEW Report" Software for report  
"KEW Report" transfers measurement data from the KEW6010B to a PC via MODEL8212-USB or MODEL8212-RS232C.





# MULTI FUNCTION TESTERS

## MODEL 6011A

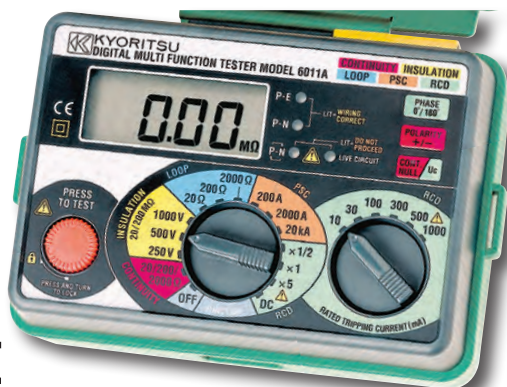

CE

The Model 6011A can perform FIVE separate test functions: insulation, continuity, earth loop impedance, prospective short circuit current and RCD trip testing in full compliance with IEC 61557.

### 5 in 1

#### Continuity

20/200/2000Ω

#### Loop

20/200/2000Ω

#### PSC

200/2000/20kA

#### Insulation

250/500/1000V

#### RCD

10/30/100/300/500/1000mA

	6011A
<b>Continuity testing</b>	
Measuring ranges	20/200/2000Ω(Autoranging)
Open circuit voltage	>6V
Short circuit current	>200mA DC
Accuracy	±(1.5%rdg+3dgt)
<b>Insulation testing</b>	
Measuring ranges	20/200MΩ(Autoranging)
Test voltage	250/500/1000V DC
Output voltage on open circuit	250V+40%, -0% 500+30%, -0% 1000V+20%, -0%
Rated current	> 1mA
Accuracy	±(1.5%rdg+3dgt)
<b>Loop impedance testing</b>	
Rated voltage	230V AC +10%, -15%[50Hz]
Voltage measuring range	100 - 250V AC[50Hz]
Impedance ranges	20/200/2000Ω
Nominal test current	25A(20Ω range) 15mA(200Ω range) 15mA(2000Ω range)
Accuracy	20Ω range ±(3%rdg+4dgt) 200Ω range ±(3%rdg+8dgt) 2000Ω range ±(3%rdg+4dgt)
<b>PSC testing</b>	
Rated voltage	230V AC +10%, -15%[50Hz]
PSC ranges	200A(15mA Test current) 2000A(25A Test current) 20kA(25A Test current)
Accuracy	PSC accuracy derived from measured loop impedance specification and measured voltage specification
<b>RCD testing</b>	
Rated voltage	230V AC +10%, -15%[50Hz]
Trip current settings	RCD x 1/2 :10,30,100,300,500,1000mA RCD x 1 : 10,30,100,300,500,1000mA RCD x 5 : 10,30,100,300mA (on x 5 range max current 1A)
Trip current duration	RCD x 1/2 x 1 : 2000ms RCD fast : 50ms
Accuracy	Trip current +10% -0% of test current at 230V Trip time ±(1%rdg + 3dgt)
<b>General</b>	
Applicable standards	IEC 61010-1 CAT III 300V pollution degree 2 IEC 61557 IEC 60529(IP54)
Power source	R6 or LR6 x 8
Dimensions	130(L) x 183(W) x 100(D)mm
Weight	1100g approx.
Accessories	KAMP10(Test lead with IEC connector)* 7122B(Test leads), 7132A(KSLP5)(External earth probe) 9092(Cord case), 9121(Shoulder strap) R6(AA) x 8, Instruction manual
Optional	7133B(Distribution board test leads)

\* KKAMP10(EU): European SHUKO plug KAMP10(UK):British plug(13A)  
KAMP10(AU):Australian plug KAMP10(UK):South african plug

## Accessories

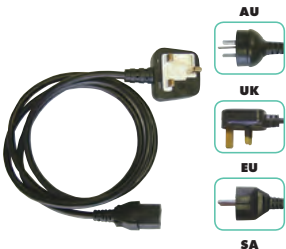

**KAMP 10**  
Test lead with IEC connector



**MODEL 7122B**  
Test leads



**MODEL 7132A (KSLP5)**  
External earth probe (6011A only)

## Optional Accessory



**MODEL 7133B (OMA DIEC)**  
Distribution board test leads

# MULTI FUNCTION TESTERS

## KEW 6016



A single rotary dial to make your selection.



Slim remote probe with test button as well as a lockdown option on the instrument for the most convenient hands free testing.



### Continuity Measurement

Continuous testing can be carried out by use of the test button lockdown feature. A selectable buzzer gives instantaneous indication of continuity. Null facility eliminates the test lead resistance from the results, the nulled value is retained even if the instrument is switched off. Live circuit warnings are given by a flashing LED, buzzer and indication on the display.

### Insulation Measurement

Three selectable test voltages 250V, 500V and 1000V. An auto-discharge function ensures that circuits are not hazardous after testing. A red LED gives warning of high voltage output during testing and discharging of the circuit. In case of connecting to a live circuit, a live circuit warning is given by flashing LED, buzzer and indication on the display.

### Loop Impedance Measurement

A patented (ATT) low current loop impedance test enables high accuracy loop measurements (up to 0.01 ohm) and quick testing without tripping RCDs. A high current alternative is selectable for even higher accuracy and instantaneous results. The subsequent test will default to the low current test, this saves any inadvertent tripping of the RCD. The KEW6016 allows also for phase to phase loop tests.

### PSC / PFC Measurement

The Prospective Short Circuit Current (PSC) and Prospective Fault Current (PFC) are automatically calculated and shown on the display. As loop testing, the function has low and high test current options with the default to low current to avoid inadvertent tripping of RCDs.

### RCD Measurement

The KEW 6016 has a comprehensive RCD test feature for RCD type AC (Alternative Currents), RCD type A (Pulsating Direct Currents), General and Selective (delayed). Measures at 1/2 x, 1x, 5x of nominal RCD current. It also has Ramp Test and Auto test where all results are shown on one screen. Touch voltage limit can be selected for 25V or 50V depending on application.

### Earth Measurement

Using the classical Volt-Amper method with two auxiliary earth spikes and without external power source. All test leads and spikes are supplied as standard accessories.

### Phase rotation

KEW 6016 can check the phase rotation of three phase lines with clear indication of the sequence on the display.

### Voltage Measurement

In addition to the voltage measurement, this function gives also the Frequency of the voltage under test.

### Memory Function

Save and display up to 1000data.

### 10 in 1

#### Continuity

20/200/2000Ω

#### Insulation

250/500V

#### Loop

20/200/2000Ω

#### PSC

2000A/20kA

#### PFC

2000A/20kA

#### RCD

10/30/100/300/500/1000mA

#### Earth

20/200/2000Ω

#### ACV

500V

#### Phase rotation

#### Frequency

### Hands Free Testing



The instrument features a test button in the probe and a lockdown test button for 'hands free' operation.

### RCD (ELCB)-Auto Test

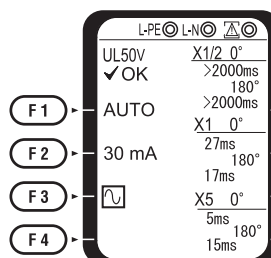

Auto test enables complete testing of RCD (6 tests) while the operator simply stands by and resets the RCD. All the results are displayed on one screen - no need to scroll.

# MULTI FUNCTION TESTERS

6016

<b>Continuity</b>	
Range	20/200/2000Ω (Auto-ranging)
Open circuit voltage (DC)	5V±20% <sup>(*)</sup>
Short circuit current	>200mA
Accuracy	±0.1Ω (0 - 0.19Ω) ±2%rdg+8dgt (0.2 - 2000Ω)
<b>Insulation resistance</b>	
Range	20/200/2000MΩ (Auto-ranging)
Open circuit voltage (DC)	20/200MΩ: 250V+25% -0% 20/200/2000MΩ: 500V+25% -0%, 1000V+20% -0%
Rated current	20/200MΩ: 1mA or > @ 250kΩ 20/200/2000MΩ: 1mA or > @ 500kΩ, @ 1MΩ
Accuracy	20/200MΩ: ±2%rdg+6dgt (0 - 19.99MΩ) ±5%rdg+6dgt (20 - 200MΩ) 20/200/2000MΩ: ±2%rdg+6dgt (0 - 199.9MΩ) ±5%rdg+6dgt (200 - 2000MΩ)
<b>Loop impedance</b>	
Function	L-PE, L-PE (ATT), L-N / L-L
Rated voltage	L-PE, L-PE (ATT): 100 - 260V (50/60Hz) L-N: 100 - 300V (50/60Hz) L-L: 300 - 500V (50/60Hz)
Nominal test current at 0Ω external loop:	20Ω: 6A/20ms 200Ω: 2A/20ms 2000Ω: 15mA/500ms
Magnitude/Duration at 230V	L-N: 6A/60ms N-PE: 10mA/approx. 5s
Range	20/200/2000Ω Auto-Ranging (L-N < 20Ω)
Accuracy	L-PE, L-N / L-L: ±3%rdg+4dgt <sup>*2</sup> ±3%rdg+8dgt <sup>*3</sup> L-PE (ATT): ±3%rdg+6dgt <sup>*2</sup> ±3%rdg+8dgt <sup>*3</sup>
<b>PSC (L-N/L-L) / PFC (L-PE)</b>	
Function	PSC, PFC, PFC (ATT)
Rated voltage	PSC: 100 - 500V 50/60Hz PFC, PFC (ATT): 100 - 260V 50/60Hz
Nominal test current at 0Ω external loop:	PSC: 6A/20ms PFC: 6A/20ms, 2A/20ms, 15mA/500ms
Magnitude/Duration at 230V	PFC (ATT): L-N: 6A/60ms, N-PE: 10mA/approx. 5s
Range	2000A/20kA Auto-Ranging
Accuracy	PSC/PFC accuracy is derived from measured loop impedance specification and measured voltage pecification
<b>RCD</b>	
Function	X1/2, X1, X5, Ramp, Auto, Uc
Trip current setting	X1/2, X1, Uc: 10/30/100/300/500/1000mA X5: 10/30/100mA Ramp: 10/30/100/300/500mA

<b>RCD</b>	
Trip current Duration	X1/2: 2000ms X1: G:550ms / S: 1000ms X5: 410ms
	Ramp: Goes up by 10% from 20% to 110% G:300ms/S:500msX10 times
Rated voltage	X1/2, X1, X5, Ramp, Uc: 230V+10%-15% 50/60Hz
	Auto: Depending on the accuracy at each function. Measurement sequence: X1/2 0°→X1/2 180°→X1 0°→X1 180°→X5 0°→X5 180° Measurements with x5 are not carried out for RCDs with nominal current of 100mA or more.
Accuracy	Trip current AC Type: X1/2: -8% - -2%, X1, X5: +2% - +8%, Ramp: ±4% A Type: X1/2: -10% - 0%, X1, X5: 0% - +10%, Ramp: ±10% Uc: +5% - +15%rdg±8dgt
<b>Earth</b>	
Range	20/200/2000Ω Auto-Ranging
Accuracy	20Ω: ±3%rdg+0.1Ω 200/2000Ω: ±3%rdg+3dgt (Auxiliary earth resistance 100±5%)
<b>Phase Rotation</b>	
Rated Voltage	50-500V 50/60Hz
Remarks	Correct phase sequence: are displayed "1.2.3" and ◯ mark Reversed phase sequence: are displayed "3.2.1" and ◯ mark
<b>Volts</b>	
Function	Volts
Rated voltage	25 - 500V, 45 - 65Hz
Measuring range	25 - 500V
Accuracy	±2%rdg+4dgt
<b>General</b>	
Applicable standards	IEC 61010-1 CAT III 300V(500V L to L) Pollution degree 2 IEC 61557-1,2,3,4,5,6,7,10 IEC 60529(IP40), IEC 61326(EMC)
Power source	LR6 × 8
Dimensions	136(L) × 235(W) × 114(D)mm
Weight	1350g (including batteries.)
Accessories	Main test lead <sup>*1</sup> 7196A(test leads with remote control switch) 7188A(Distribution board fused test leads) 7228A(Earth resistance test leads) 8032(Auxiliary earth spikes[2 spikes/set]) 8212-USB(USB adaptor with KEW Report(Software)) 9014(Cord case), 9142(Carrying Case), 9121(Shoulder strap), Buckle, Battery, Instruction manual
Optional	8212-RS232C(RS232C adaptor with KEW Report(Software))

\*1: Voltages are output when measurement resistance is under 2100 ohm.  
\*2: 230V+10%-15%  
\*3: Other voltages except for \*2  
\*4: 7187A:British plug, 7218A:(EU)European SHUKO plug,  
7221A(SA) South african plug, 7222A:(AU)Australian plug

## Accessories



**MODEL 7188A**  
Distribution board fused test leads



**MODEL 7196A**  
Test leads with remote control switch



**Main test lead**



7187A  
7221A  
7218A  
7222A  
Plug



**MODEL 7228A**  
Earth resistance test leads



**MODEL 8032**  
Auxiliary earth spikes  
[2 spikes/set]



**MODEL 9142**  
Carrying Case

### Optional Accessories



**MODEL 8212-USB**  
USB adaptor with "KEW Report (Software)"



**MODEL 8212-RS232C**  
RS232C adaptor with "KEW Report (Software)"

**"KEW Report" Software for report**  
"KEW Report" transfers measurement data from the KEW6016 to a PC via MODEL8212-USB or MODEL8212-RS232C.



**System requirements**  
OS: Windows® Vista/7(32/64bit)/8(32/64bit)  
Display: XGA (Resolution 1024 x 768 dots) or more  
Hard-disk: Space required: 20Mbyte or more  
Others: With CD-ROM drive and USB port  
\* Windows® is a registered trademark of Microsoft in the United States.



# POWER QUALITY ANALYZER



POWER METERS



# POWER METERS

Selection Guide of Power Meters

	Power Quality Analyzer	Power Meter	Loggers	
	6315	6305	5020	5010
Appearance				
Voltage [V]	✓	✓	✓	✓
Current [A]	✓	✓	✓	✓
Power [W]	✓	✓	-	-
Frequency [Hz]	✓	✓	-	-
Energy [Wh]	✓	✓	-	-
Harmonics	✓	-	-	-
Power Quality	Swell	✓	-	✓
	Dip	✓	-	✓
	Interruption	✓	-	✓
	Transients	✓	-	-
	Inrush Current	✓	-	✓
Memory	SD card	SD card	Inner memory	Inner memory
Number of Input Channel	7ch (V3,A4)	6ch (V3,A3)	3ch	3ch

## Power Quality

### ● Swell

Swell is a instantaneous voltage increase, most of the time originated by upstream power line failure or switching OFF large load or switching ON large capacitor.

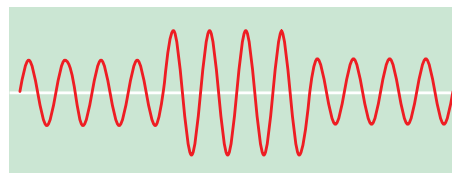

### ● Dip

Dip, as the opposite of a swell, is a instantaneous voltage decrease, most of the time caused by switching ON large load e.g. motors or by down-stream power line failure.

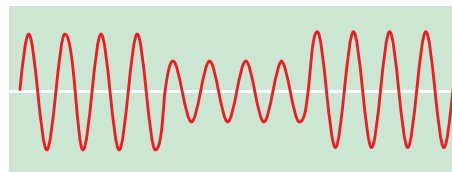

### ● Interruption

Interruption is a power line cut-off from any source of supply. It can be caused by a fault in a power line, which causes switch gear to open.

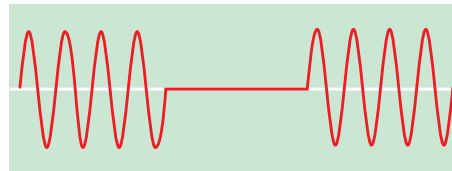

### ● Transients/Over Voltage (Impulse)

Transient is a very fast and momentary voltage increase that can seriously damage devices connected to a power line. It may be caused by electrical switching events such as instable contacts of relays, tripping of breakers but also by lightning. KEW 6315 can catch Transients from 24  $\mu$ s.

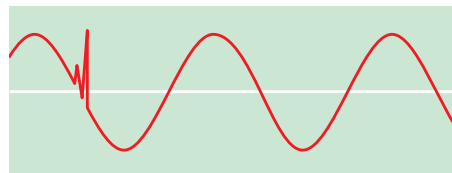

### ● Inrush Current

Inrush current is a surge current that happens when motors, large or low-impedance loads are switched ON. Then the current will stabilize as soon as the load has reached normal working conditions.

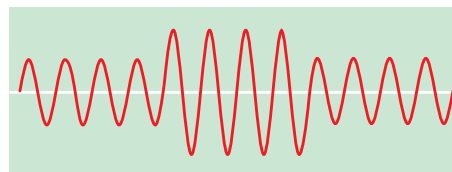



# POWER QUALITY ANALYZER

KEW **6315** **NEW**

RMS CAT IV 300V CAT III 600V



- Simultaneous Power & Power quality measurements  
Power/Harmonics/Waveform/Power quality are recorded at all CHs. (Voltage:3ch,Current 4ch)
- Helpful support functions  
Quick Start Guide,Wiring check and Sensor detection for easy and reliable measurement
- Measurement with high accuracy  
Guaranteed accuracy:  $\pm 0.3\%rdg(energy)$ ,  
 $\pm 0.2\%rdg(voltage/current)$   
Complies with the International Standard  
IEC 61000-4-30 Class S and the European Standard EN50160
- Energy consumption check on site  
Trend and demand graphs for easy recognition. TFT color display with high resolution.
- IEC 61010-1 CAT IV 300V,CAT III 600V,CAT II 1000V

		6315
Wiring connections		1P2W, 1P3W, 3P3W, 3P4W
Measurements and parameters		Voltage, Current, Frequency, Active power, Reactive power, Apparent power, Active energy, Reactive energy, Apparent energy, Power factor (cos $\theta$ ), Neutral current, Transients/ Over Demand, Harmonics, Quality(Swell/Dip/Interruption, voltage, Inrush current, Unbalance rate), Phase advance condenser, IEC Flicker
Other functions		Digital output function, External communication function,Scaling function
Voltage [RMS]	Range	600.0/1000V
	Accuracy	$\pm 0.2\%rdg \pm 0.2\%f.s.$ (sine wave, 40 - 70Hz)
	Allowable input	1 - 120% of each range (rms). 200% of each range (peak)
	Display range	0.15 - 130% of each range
	Crest factor	3 or less
Current [RMS]	Range	8128(50A type) : 5/50A/AUTO, 8127(100A type) : 10/100A/AUTO 8126(200A type) : 20/200A/AUTO, 8125(500A type) : 50/500A/AUTO 8124/8130(1000A type) : 100/1000A/AUTO, 8146/8147/8148(10A type) : 1/10A/AUTO, 8129(3000A type) : 300/1000/3000A
	Accuracy	$\pm 0.2\%rdg \pm 0.2\%f.s.$ +accuracy of clamp sensor (sine wave, 40 - 70Hz)
	Allowable input	1 - 110% of each range (rms). 200% of each range (peak)
	Display range	0.15 - 130% of each range
Active power	Accuracy	$\pm 0.3\%rdg \pm 0.2\%f.s.$ + accuracy of clamp sensor (power factor 1, sine wave, 40 - 70Hz)
	Influence of power factor	$\pm 1.0\%rdg$ (reading at power factor 0.5 against power factor 1)
Frequency meter range		40 - 70Hz
Power supply (AC Line)		AC100 - 240V/50 - 60Hz/7VA max
Power supply (DC battery)		LR6 or Ni-MH(HR15-51) $\times 6$ Battery life approx. 3h (LR6,Backlight OFF)
Memory card		SD card (2GB)
PC communication interface		USB Ver2.0, Bluetooth Ver2.1+EDR Class2
Display		320 $\times$ 240(RGB)Pixel, 3.5inch color TFT display
Temperature and humidity range		23 $\pm$ 5 $^{\circ}$ C less than 85% RH (without condensation)
Operating temperature and humidity range		0 - 45 $^{\circ}$ C leaa than 85% RH (without condensation)
Storage temperature and humidity range		-20 - 60 $^{\circ}$ C less than 85% RH (without condensation)
Applicable standards		IEC 61010-1 CAT IV 300V, CAT III 600V, CAT II 1000V Pollution degree 2, IEC 61010-2-030,IEC 61010-031, IEC 61326,EN50160 IEC 61000-4-30 Class S, IEC 61000-4-15, IEC 61000-4-7
Dimension/Weight		175(L) $\times$ 120(W) $\times$ 68(D) mm/approx 900g
Included accessories		7141B(Voltage test lead), 7170(Power cord), 7219(USB cable), 8326-02(SD card 2GB), 9125(Carrying case),Input terminal plate $\times 6$ , KEW Windows for KEW6315(software), Quick manual, Alkaline size AA battery(LR6) $\times 6$

## Simultaneous Power & Power quality measurements



### Power & Energy

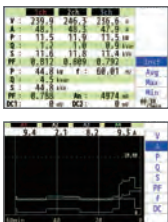

#### Instantaneous value

- Measures instantaneous / average / min / max for voltage, current, active / reactive / apparent power, PF (cosfi) and line frequency all on one screen.
- Trend of all main parameters and customized Zoom functions.

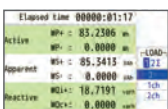

#### Integration value

- The display will list the active / reactive / apparent energy in total and for each phase consumed (or generated in case of co-generation like solar panels, etc).



#### Demand

- To support demand control, present energy usage and estimated value are displayed on a graph while recording max demand value and the occurred time.



### Vector

- Can display voltage and current by vector per Ch.

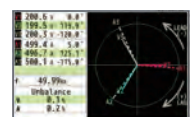

### Waveform

- Displays voltage and current on each Ch by waveform.

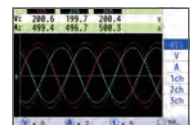

### Harmonics Analysis

- Graphic display of harmonic components up to 50th order for voltage, current and power.

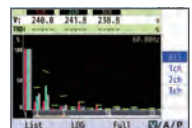

### Event

- Measures voltage swells / dips / interruptions / transients and inrush currents that may indicate a weak power distribution system. Such phenomena may damage or reset devices. All necessary data is displayed by pressing one key.

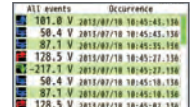



# POWER QUALITY ANALYZER

## Quick Start Guide

One-Touch START/STOP Key for Quick Start Guide providing easy setup guides.

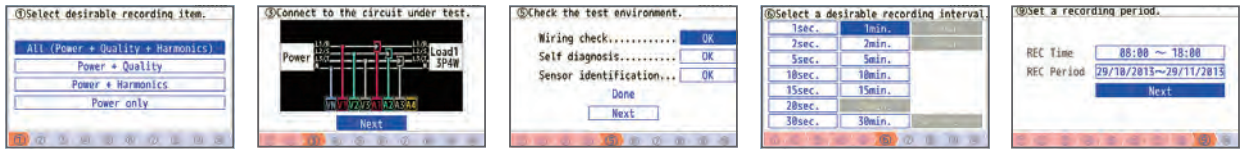

Guide start

Connect to the circuit

Wiring check

Select interval

Set recording time

Start recording

## Windows software for data analysis and setting via USB port

- Automatic creation of graph and list from recorded data.
- Uniform management of setting and recorded data acquired from multiple devices.
- Data can be expressed in crude oil and CO<sub>2</sub> equivalent values in the report.
- EN50160 report can be generated after survey.

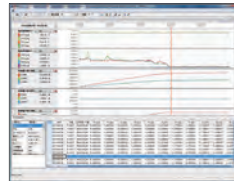

<System requirements>

- OS : Windows®Vista/7(32/64bit)/8(32/64bit)
  - Display : XGA(Resolution 1024×768 dots) or more
  - Hard-disk: Space required 1Gbyteor more
  - Other : With CD-ROM drive and USB port.  
NET Framework (3.5 or more)
- \*Windows®is registered trademark of Microsoft in the United States.

## Real time and Remote measurements

- Measurements can be graphically displayed on Android devices or PC in real-time via Bluetooth communication.

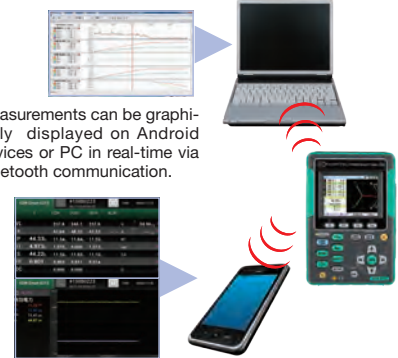

\*Bluetooth is a registered trademark of the Bluetooth SIG, Inc.  
Android is a registered trademark of the Google Inc.

## Optional Accessories

### Load current clamp sensors



### Leakage & Load current clamp



\*8146/8147/8148 can measure up to 10A

### Load current flexible clamp sensors



### Can you close your distribution board door during surveys?

The KEW6315 facilitates safe testing by being extremely compact and with two clever option extras: a magnetic case(9132) for attaching it to the sides of metal enclosures and a power supply adaptor(8312) which takes the power for the instrument from the supply being measured.



## SD card Interface

- SD cards up to 2GB can be used
- Possible recording time  
When the 2GB of SD is used:



Interval	REC item	
	Power	+Harmonics
1sec	13days	3days
1min	1-year or more	3months
30min	10-year or more	7-year or more

Data of power quality events are not considered to estimate the possible recording time. The max possible time will be shortened by recording such events.

## Set Model



**KEW 6315-01**  
8125(500A) x 3  
Carrying case : 9125



**KEW 6315-03**  
8130(1000A) x 3  
Carrying case : 9135



# POWER METER

## KEW 6305

RMS



- Comprehensive real-time monitoring, recording and analysis of single and 3-phase systems
- Voltage, Current, Power Factor and Frequency measurements
- Power analysis (Active, Apparent and Reactive power)
- Energy analysis (Active, Apparent and Reactive energy)
- Active power accuracy:  $\pm 0.3\% \text{rdg} \pm 0.2\% \text{f.s.}$
- Automatic wiring check function to prevent incorrect connections
- Large memory capability (2 GB) using built-in SD card Interface
- Recording interval can be set between 1second and 1hour.
- Real time & remote measurements using Android application
- Windows software for data analysis and setting via USB port or Bluetooth

- Synchronous measurements between two units of KEW6305
- Wide selection of clamp sensors allow measurements from 0.1A to 3000A
- The instrument automatically recognizes what kind of clamp sensor is connected to it
- Double power supply system via AC line and batteries

## As easy as 1 → 2 → 3!

Starting from OFF position and rotating the Rotary switch clockwise, KEW6305 is ready to use in 3 simple steps

### 1. SET UP

Rotate the Rotary switch to SET UP. All the instrument settings can be easily selected by using instrument buttons. All the settings can also be selected by connecting KEW6305 to a PC via USB or Bluetooth.

### 2. WIRING CHECK

Rotate the Rotary switch to WIRING CHECK. The Automatic Wiring check function will prevent incorrect connections, check the connections and display the results on the LCD. Error messages appear on display to indicate wrong orientation of Clamp sensors or incorrect connections.

Everything is OK

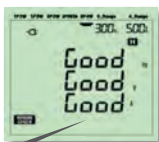

Shows "Good"

Error is found

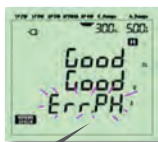

Shows "Err" (Error) e.g.; Err PH A  
→ Current phase (orientation of sensor) may be incorrect.

### 3. W/Wh/DEMAND Measurements

Rotate the Rotary switch to W/Wh/DEMAND. The instrument can perform Instantaneous, Integration and DEMAND measurements. START / STOP button to start / stop recording

	6305
Wiring connections	1P2W, 1P3W, 3P3W, 3P3W3A, 3P4W
Measurements	Voltage, Current, Frequency, Active power
Parameters	Apparent power, Reactive power, Active energy, Apparent energy, Reactive energy, Power factor (cos $\theta$ ), Neutral current
Voltage range[RMS]	150.0/300.0/600.0V
Voltage accuracy	$\pm 0.2\% \text{rdg} \pm 0.2\% \text{f.s.}$ (sine wave, 45 - 65Hz)
Current range[RMS]	10.00/50.00/100.0/250.0/500.0A/Auto (with clamp sensor MODEL8125)
Current accuracy	$\pm 0.2\% \text{rdg} \pm 0.2\% \text{f.s.}$ + Accuracy of Clamp sensor (sine wave, 45 - 65Hz) * $\pm 1\% \text{f.s.}$ at the lowest range.
Effective input range	10 - 110% of rating range
Display range	5 - 130% of each range (Voltage) 1 - 130% of each range (Current)
Crest factor	Voltage : up to 2.5, Current : up to 3.0 (with 90% fs or less)
Active power accuracy	$\pm 0.3\% \text{rdg} \pm 0.2\% \text{f.s.}$ + Accuracy of Clamp sensor * $\pm 1\% \text{f.s.}$ when the lowest current ranges is selected.
Effect of power factor	Active power: $\pm 1.0\% \text{rdg}$ cos $\theta = \pm 0.5$ (PF=1)
Frequency meter range	40.0 - 70.0Hz
Frequency meter accuracy	$\pm 3 \text{dgt}$
Accuracy precondition	PF=1, Sine wave, 45 - 65Hz, 23°C $\pm 5^\circ \text{C}$
Display update period	1 second
Operating temperature and humidity range	0 - +50°C, less than 85% RH (without condensation)
Storage temperature and humidity range	-20 - +60°C, less than 85% RH (without condensation)
PC communication interface	USB, Bluetooth
PC card interface	SD card (2GB)
Safety standard	IEC 61010-1 CAT III 600V
Power supply (AC Line)	AC100 - 240V $\pm 10\%$ (50/60Hz)
Power supply (DC battery)	LR6 or Ni-MH(HR-15-51) $\times 6$ (Battery charger not included), Battery life approx. 15h (LR6)
Power consumption	10VA (max.)
Dimension	175(L) $\times$ 120(W) $\times$ 65(D)mm
Weight	Approx. 800g (including batteries)
Accessories	7141B (Voltage test lead set: 4pcs), 7148 (USB cable), 7170(Powercord), 9125(Carrying case), 8326-02 (SD card 2GB), KEW WINDOWS (PC Software), Battery(LR6) $\times 6$ , Quick manual
Optionals	8124, 8125, 8126, 8127, 8128 (Clamp sensor), 8129, 8130 (Flexible clamp sensor), 8312 (Power supply adaptor), 9132 (Magnetic carrying case)

# POWER METER

## Bluetooth communication with Android application

Free Android software "KEW Smart 6305" is available on download site



Download



\*communication charges may be incurred separately to download application

### Real time & remote measurements using Android application

Measurement can be displayed in graphic or numeric forms on Android devices in real-time via Bluetooth communication.

Remote checking of measurements is possible without accessing KEW6305.



Android device

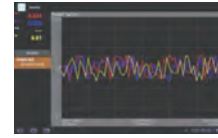

Real-time display

Max communication distance: 10m  
Supporting Android ver. 2.2 - 4.4

Bluetooth is a registered trademark of the Bluetooth SIG, Inc.  
Android is a registered trademark of the Google Inc.

## Windows software

Automatic creation of graph and list from recorded data.  
Uniform management of setting and recorded data acquired from multiple devices.

Data can be expressed in crude oil and CO<sub>2</sub> equivalent values in the report.

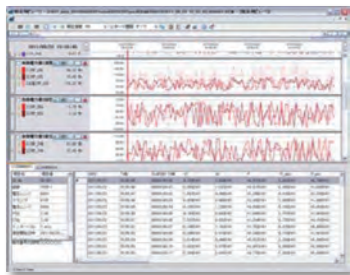

### [System requirements]

OS: Windows® Vista/7(32/64bit)/8(32/64bit)  
Display: XGA(Resolution 1024x768 dots) or more  
Hard-disk: space required 1Gbyte or more  
Other: With CD-ROM drive and USB port  
.NET Framework (3.5 or more)

\* Windows® is a registered trademark of Microsoft in the United States.

## SD card Interface



### Max amount of data (reference)

Data saved on:	SD card	Internal memory
Capacity	2GB	3MB
Instantaneous measurement	6,670,000	10,000
Integration / demand measurement interval	1 sec.	17 days
	1 min.	992 days
	30 min.	33 hours
Max number of file	3 years or more	42 days
	511	4

\*in case the SD card is empty

SD cards up to 2GB can be used.

## Set Model

### KEW 6305-01

KEW 6305 x 1  
MODEL 8125 x 3



Carrying case : 9125

### KEW 6305-03

KEW 6305 x 1  
MODEL 8130 x 3



Carrying case : 9135

## Optional

### Load current clamp sensors

#### MODEL 8128



CE  
MAX 50A Ø24

#### MODEL 8127



CE  
MAX 100A Ø24

#### MODEL 8126



CE  
MAX 200A Ø40

#### MODEL 8125



CE  
MAX 500A Ø40

#### MODEL 8124



CE  
MAX 1000A Ø68

### Load current flexible clamp sensors

#### KEW 8129

8129-01 (for 1ch)  
8129-02 (for 2ch)  
8129-03 (for 3ch)

FLEXIBLE CLAMP SENSOR WITH 3 RANGES  
AC300, 1000, 3000A

MAX 3000A Ø150



CE

### Power supply adaptor

#### MODEL 8312

For taking single phase supply (100-240V) from the test leads to power the instrument (FUSE: 8923)



### Magnetic carrying case

#### MODEL 9132

For mounting inside metal distribution boards



#### KEW 8130

FLEXIBLE CLAMP SENSOR  
AC1000A

MAX 1000A Ø110



CE



# LOGGERS

## KEW 5010/5020



True RMS

**3 channel inputs for the simultaneous recording of Leakage Current, Load Current and Voltage**

**Power Quality analysis. (only on KEW 5020)**

(Power Quality: Reference voltage, Swell, Dip, Short power Interruptions)

**Large capacity for storing 60,000 data points**

60,000 data points can be recorded when 1ch is used, and when all the three channels are used, 20,000 data points per channel can be recorded.

**Lowpass Filter will filter out the harmonics.**

(Cutoff Frequency = Approx. 160Hz)

**LED flickers when the preset current / voltage value is exceeded.**

(Available for Trigger / Capture Recording, Power Quality Analysis modes)

**CALL : Confirmation of recorded data**

- The following can be displayed: number of recorded data points, (max+ min+ peak) value for each channel complete with time/date information in the Normal recording mode. (Detected values (i.e. when values are outside preset limits) can be displayed in other recording modes)
- RECALL: The last 10 recorded data points including time/date can be recalled on the logger display.



**Selection of One-time mode or Endless mode**

**One-time on : →**

Recording will stop when memory is used up.

**One-time off : ↻**

Overwrite the old data, and store the latest data.

**Non Volatile Memory**

Recorded data will be retained even if the batteries are exhausted or replaced due to the presence of a nonvolatile memory (guaranteed for 10 years)

**Battery power indicator**

Indicates battery voltage in 4-levels.

(It is possible to use the logger for a further approx 24 hours even after the warning symbol is flashing.)

**The user friendly PC software " KEW LOG Soft "is supplied.**

- Supplied with the user friendly software " KEW LOG Soft 2".
- This permits editing, analysis and graphical display of data.
- The recorded data is downloadable onto a PC via USB cable.
- Variation of the measured voltage and current data can be confirmed simultaneously on the PC display monitor. (only on KEW 5020)
- Simplified Power Integration  
(The "KEW LOG Soft 2" uses current and voltage recorded to calculate the integral power consumption)
- Continuous measuring time : Approx. 10 days (Alkaline Battery)

	5010	5020
Recording mode	Normal, Trigger, Capture	Normal, Trigger, Capture, Power quality analysis
Operating system	Successive approximation(CH1 single synchronized sampling)	
Rated max. working voltage	AC9.9Vrms, 14V peak value	
Number of input channel	3ch	
Measuring method	True RMS	
RMS measuring interval	approx. 100ms.	
Sampling interval	: Normal / Trigger mode	approx. 1.65ms/CH
	: Capture mode	approx. 0.55ms (waveform: at every 1.1ms)
	: P.Q.A mode	—
		approx. 0.55ms
Low battery warning	Battery mark display (in 4 levels)	
Over-range indication	"OL" mark is displayed when exceeding the measuring range	
Auto power off	Power-off function operates automatically after a switch remains for 3min. (when recording is stopped)	
Location for use	Indoor use, Altitude up to 2000m	
Operating temperature & humidity range	-10°C - 50°C / Relative humidity 85% or less (no condensation)	
Battery	DC6V : Alkaline battery(LR6) × 4pcs / External supply DC9V(Special AC Adaptor)	
Possible measurement time	Approx.10days (with alkaline LR6 batteries)	
Applicable standards	IEC 61010-1 CAT III 300V Pollution degree2 IEC 61326 (EMC)	
Dimensions	111(L) × 60(W) × 42(D)mm	
Weight	Approx. 265g	
Accessories	Alkaline battery LR6×4 9118(Carrying case[Soft]) KEW LOG Soft 2(PC software) 7148(USB cable) Instruction manual Quick manual Install manual USB Notice sheet	
Optional	8146/8147/8148(Leakage & Load current clamp sensor) 8121/8122/8123(Load current clamp sensor) 8129(Flexible clamp sensor) 8309(Voltage sensor : only KEW5020) 8320(AC adaptor) 9135(Carrying case) 7185(Extension cable)	

**Normal Recording Mode**

(AC 50/60Hz, Sine wave, Input: 10% or more of the range at CH1)

Range	RMS Accuracy
100.0mA	±2.0%rdg±0.9%f.s. + Accuracy of sensor
Other ranges	±1.5%rdg±0.7%f.s. + Accuracy of sensor
Crest factor	2.5 or less :RMS accuracy(sine)+ 2%rdg+1%f.s.

\*Max, Min and Instant Peak values in Normal Recording mode are just reference values; their accuracies aren't guaranteed.

**Trigger Recording Mode**

(AC 50/60Hz sine wave)

Range	Accuracy
100.0mA	±3.5%rdg±2.2%f.s. + Accuracy of sensor
Other ranges	±3.0%rdg±2.0%f.s. + Accuracy of sensor

**Capture/ Power Quality Analysis Recording Mode**

Range	Accuracy
100.0mA	±3.0%rdg±1.7%f.s. + Accuracy of sensor
Other ranges	±2.5%rdg±1.5%f.s. + Accuracy of sensor

## 4 recording modes make various measurements possible



### Normal recording mode

**NORM** For monitoring power line status or an intermittent leakage.

- Records the variation of the current / voltage in a given interval (For monitoring the variation of the current / voltage against time.)
- A choice of 15 recording intervals are available: 1 sec. to 60 min. (1,2,5,10,15,20,30 sec, 1,2,5,10,15,20,30,60 min.)
- The average of the measured value in every recording interval is recorded. The Max., Min. and Peak values (sampled crest value converted to sine RMS value) are recorded every 10 readings.

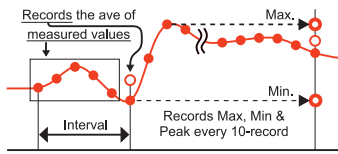

### Trigger recording mode

**TRIG** For observing an irregular operation of an ELCB/RCD, an irregular current / voltage.

- Detects the value, time and frequency of the current / voltage when the preset value is exceeded.
- When the detection level (i.e. preset value) is exceeded, 8 data points (True RMS values for approx. 0.8 sec) and peak value are recorded before and after the preset value is exceeded.
- Inrush current or an abnormal current / voltage can be detected by sampling the inputs at every 1.6ms.
- LED flickers when the measured values exceed the preset current / voltage value.

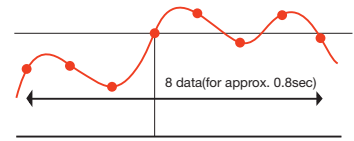

### Capture recording mode

**CAP** For observing waveforms easily.

- Waveform display via a PC by sampling the inputs every 0.55ms.
- When the preset current / voltage value is exceeded, instantaneous values are recorded for 200ms (from 10(50Hz) to 12 (60Hz) waveforms) before and after preset value is exceeded.
- LED flickers when the measured values exceed the preset current / voltage value.

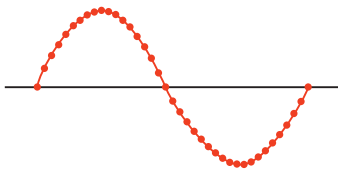

### Power Quality Analysis Mode

**PQA** For monitoring and observing voltage fluctuations.

- Detects the reference voltage, Swell, Dip and Short Interruption. Records the values detected with the start time and end time.
- Samples the inputs every 0.55ms and detects the voltage fluctuation every 10ms.
- LED flickers when the voltage fluctuation is detected.

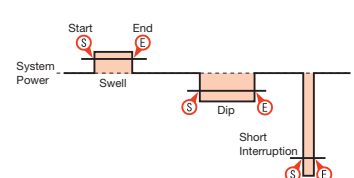

## Analyzing and processing the recorded data with a PC

The user friendly PC software "KEW LOG Soft 2" is supplied.

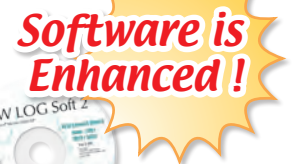

### System requirements

OS: Windows® Vista/7(32/64bit) /8(32/64bit)  
 Display: XGA(Resolution 1024 x 768 dots) or more

Hard-disk: Space required 100Mbyte or more  
 Others: With CD-ROM drive and USB port  
 \* Windows® is a registered trademark of Microsoft in the United States.

### Easy to set up with a PC



(Normal and Trigger recording modes can be set up through the logger itself.)

### Large data can be easily processed

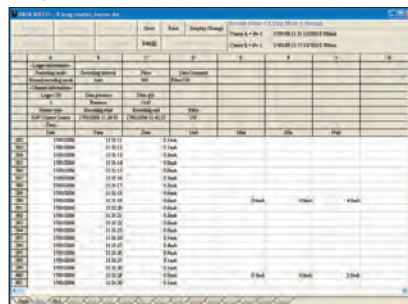

- The type of the sensor connected to the logger will be automatically recognized.
- Just click appropriate dialog boxes for set up if it is not required to input any comments.
- By using commercially available USB hub, multiple loggers can be connected to a PC and can set the synchronized time.

### A graph can be made by just one click

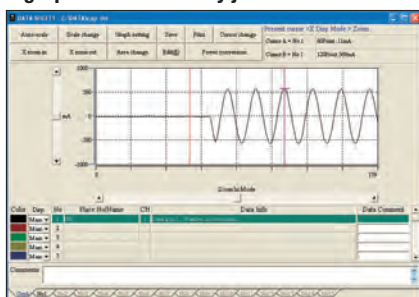

### Display of Power Quality

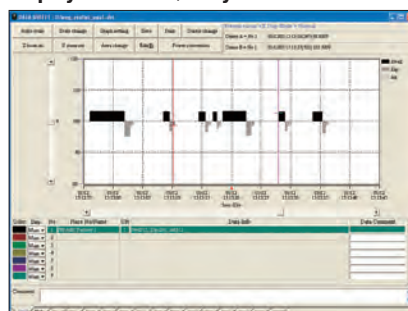

### Capable of registering the names of 1,000 sites

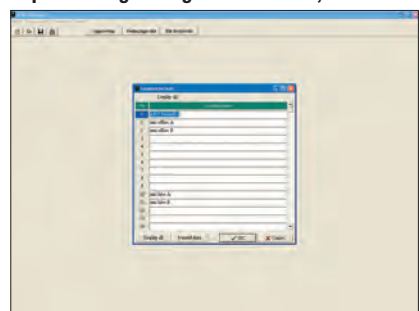

## Optional Accessories of Loggers, Power Meter and Power Quality Analyzer

### Applicable model table

			5010	5020	6305	6315
Sensor	Load current	8121	✓	✓		
		8122	✓	✓		
		8123	✓	✓		
		8124	✓	✓	✓	✓
		8125	✓*1	✓*1	✓	✓
		8126	✓*2	✓*2	✓	✓
		8127	✓*3	✓*3	✓	✓
		8128	✓	✓	✓	✓
		8129	✓*4	✓*5	✓	✓
	8130	✓*4	✓*5	✓	✓	
	Leakage current	8141*6	✓	✓		✓
		8142*6	✓	✓		✓
		8143*6	✓	✓		✓
Leakage & Load current	8146*6	✓	✓		✓	
	8147*6	✓	✓		✓	
	8148*6	✓	✓		✓	
Voltage sensor	8309		✓			
Adaptor	8312			✓	✓	
	8320	✓	✓			
Case	9132			✓	✓	
	9135	✓	✓			

\*1 - 5: Can use with after the following serial numbers.  
 \*1: No.02637 -  
 \*2: No.00151 -  
 \*3: No.00181 -  
 \*4: No.8029792 -  
 \*5: No.8031560 -  
 \*6: Cannot be used for power measurement.

### Voltage sensor

#### KEW 8309

Floating Voltage can be measured

Floating voltage : phase to phase voltage not grounded  
 KEW 5020-01 : KEW 5020 logger with KEW 8309 (1pce.)



CE

### Power supply adaptor

#### MODEL 8312



Power source can be taken through the measured line (100 - 240V)  
 (FUSE : 8923)

### Carrying case with magnet

#### MODEL 9132



Easy-to-use setting with magnet on the steel plate etc. of switch board

### AC adaptor (External power supply)

#### MODEL 8320



Appropriate for a longer period of recording.  
 Complies to 90 - 264V(45 - 66Hz).

### Carrying case

#### MODEL 9135



Dimensions :250(L) × 270(W) × 216(D)mm



# SENSORS

## Load current Clamp sensors

### KEW 8129

MAX 3000A Ø150

8129-01 (for 1ch)  
8129-02 (for 2ch)  
8129-03 (for 3ch)

**FLEXIBLE CLAMP SENSOR  
CAN MEASURE UP TO  
AC3000A HIGH CURRENT**



### KEW 8130 **NEW**

CAT IV 300V CAT III 600V MAX 1000A  
Ø110



	8129-01 (for 1ch)	8129-02 (for 2ch)	8129-03 (for 3ch)	8130
Conductor size	max. $\phi$ 150mm			max. $\phi$ 110mm
Rated current	300/1000/3000A			AC 1000A
Output voltage	300A Range :AC500mV/AC300A (1.67mV/A) 1000A Range :AC500mV/AC1000A (0.5mV/A) 3000A Range :AC500mV/AC3000A (0.167mV/A)			AC 500mV/1000A (AC 0.5m V/A)
Accuracy	$\pm 1.0\%$ rdg (45 - 65Hz)			$\pm 0.8\%$ rdg $\pm 0.2$ mV (45Hz - 65Hz) $\pm 1.5\%$ rdg $\pm 0.4$ mV (40Hz - 1kHz)
Phase shift	within $\pm 1^\circ$			within $\pm 2.0^\circ$ (45 - 65Hz)
Cable length Output connector	Sensor part : approx. 2m Output cable : approx. 1m MINI DIN 6PIN			Approx. 3m MINI DIN 6pin
Operating temperature & humidity ranges	0 - 50°C, relative humidity 85% or less (no condensation)			-10 - 50°C, relative humidity 85% or less (no condensation)
Output impedance	100 $\Omega$ or less			100 $\Omega$ or less
Applicable standards	IEC 61010-1, IEC 61010-2-032 CAT III 600V Pollution degree2, IEC 61326			IEC 61010-1, IEC 61010-2-030, IEC 61010-2-032 CAT IV 300V /CAT III 600V Pollution degree 2 IEC 61326
Dimensions	111(L) $\times$ 61(W) $\times$ 43(D) mm (except for protrusions)			AMP box 65(L) $\times$ 24(W) $\times$ 22(D)mm(except for protrusions)
Weight	Approx. 410g	Approx. 680g	Approx. 950g	Approx. 180g
Accessories	Instruction manual 7199 (Output cable) $\times$ 1 9137 (Carrying case)	Instruction manual 7199 (Output cable) $\times$ 2 9137 (Carrying case)	Instruction manual 7199 (Output cable) $\times$ 3 9137 (Carrying case)	Instruction manual Cable marker 9095(Carrying case)
Applicable models	5010, 5020, 6305, 6315			

### MODEL 8128

MAX 50A Ø24



### MODEL 8127

MAX 100A Ø24



### MODEL 8126

MAX 200A Ø40



### MODEL 8125

MAX 500A Ø40



### MODEL 8124

MAX 1000A Ø68



	8128	8127	8126	8125	8124
Conductor size	$\phi$ 24	$\phi$ 24	$\phi$ 40	$\phi$ 40	$\phi$ 68
Rated current	AC 5A (Max.50A)	AC 100A	AC 200A	AC 500A	AC 1000A
Output voltage	AC 50mV/5A [Max. 500mV/50A][AC 10mV/A]	AC 500mV/100A (AC 5mV/A)	AC 500mV/200A (AC 2.5mV/A)	AC 500mV/500A (AC 1mV/A)	AC 500mV/1000A (AC 0.5mV/A)
Accuracy	$\pm 0.5\%$ rdg $\pm 0.1$ mV (50/60Hz) $\pm 1.0\%$ rdg $\pm 0.2$ mV (40Hz - 1kHz)				$\pm 0.5\%$ rdg $\pm 0.2$ mV (50/60Hz) $\pm 1.5\%$ rdg $\pm 0.4$ mV (40Hz - 1kHz)
Phase shift	within $\pm 2.0^\circ$ (45 - 65Hz)		within $\pm 1.0^\circ$ (45 - 65Hz)		
Cable length : Output connector	Approx. 3m : MINI DIN 6pin				
Operating temperature ranges	-0 - 50°C, less than 85% RH ( without condensation)				
Output impedance	Approx. 20 $\Omega$	Approx. 10 $\Omega$	Approx. 5 $\Omega$	Approx. 2 $\Omega$	Approx. 1 $\Omega$
Applicable standards	IEC 61010-1, IEC 61010-2-032 CAT III 300V Pollution degree 2 IEC 61326		IEC 61010-1, IEC 61010-2-032 CAT III 600V Pollution degree 2 IEC 61326		
Dimensions	100(L) $\times$ 60(W) $\times$ 26(D)mm		128(L) $\times$ 81(W) $\times$ 36(D)mm		186(L) $\times$ 129(W) $\times$ 53(D)mm
Weight	Approx. 160g		Approx. 260g		Approx. 510g
Accessories	9095 (Carrying case)	Instruction manual	Cable marker		9094 (Carrying case) Instruction manual cable marker
Optional	7146 (Banana $\phi$ 4 adjuster plug)	7185 (Extension cable)			
Applicable models	5010, 5020, 6305, 6315				

# SENSORS

## Leakage & Load current Clamp sensors

KEW 8146

MAX 30A Ø24



KEW 8147

MAX 70A Ø40



KEW 8148

MAX 100A Ø68



	8146	8147	8148
Conductor size	φ24	φ40	φ68
Rated current	AC 30A	AC 70A	AC 100A
Output voltage	AC 1500mV/30A (AC 50mV/A)	AC 3500mV/70A (AC 50mV/A)	AC 5000mV/100A (AC 50mV/A)
Accuracy	0 - 15A ±1.0%rdg±0.1mV (50/60Hz) ±2.0%rdg±0.2mV (40Hz - 1kHz) 15 - 30A ±5.0%rdg (50/60Hz) ±10.0%rdg (45Hz - 1kHz)	0 - 40A ±1.0%rdg±0.1mV (50/60Hz) ±2.0%rdg±0.2mV (40Hz - 1kHz) 40 - 70A ±5.0%rdg (50/60Hz) ±10.0%rdg (45Hz - 1kHz)	0 - 80A ±1.0%rdg±0.1mV (50/60Hz) ±2.0%rdg±0.2mV (40Hz - 1kHz) 80 - 100A ±5.0%rdg (50/60Hz) ±10.0%rdg (45Hz - 1kHz)
Cable length : Output connector	Approx. 2m : MINI DIN 6pin		
Operating temperature ranges	-0 - 50°C, less than 85% RH (without condensation)		
Output impedance	Approx. 90Ω	Approx. 100Ω	Approx. 60Ω
Applicable standards	IEC 61010-1, IEC 61010-2-032 CAT III 300V Pollution degree 2, IEC 61326		
Dimensions	100(L) × 60(W) × 26(D)mm	128(L) × 81(W) × 36(D)mm	186(L) × 129(W) × 53(D)mm
Weight	Approx. 150g	Approx. 240g	Approx. 510g
Accessories	9095(Carrying case) Instruction manual Cable marker		9094 (Carrying case) Instruction manual Cable marker
Optional	7146(Banana φ4 adjuster plug) 7185(Extension cable)		
Applicable models	5010, 5020, 6315*		

\*Cannot be used for power measurements.

## Load current Clamp sensors

KEW 8121

MAX 100A Ø24



KEW 8122

MAX 500A Ø40



KEW 8123

MAX 1000A Ø55



	8121	8122	8123
Conductor size	φ24	φ40	φ55
Rated current	AC 100A	AC 500A	AC 1000A
Output voltage	AC 500mV/100A (AC 5mV/A)	AC 500mV/500A (AC 1mV/A)	AC 500mV/1000A (AC 0.5mV/A)
Accuracy	±2.0%rdg±0.3mV (50/60Hz) ±3.0%rdg±0.5mV (40Hz - 1kHz)		
Cable length : Output connector	Approx. 2m : MINI DIN 6pin		
Operating temperature ranges	-0 - 40°C, less than 85% RH (without condensation)		
Output impedance	Approx. 9.5Ω	Approx. 1.9Ω	Approx. 1.5Ω
Applicable standards	IEC 61010-1, IEC 61010-2-032 CAT III 300V Pollution degree 2, IEC 61326		
Dimensions	97(L) × 59(W) × 26(D)mm	128(L) × 81(W) × 36(D)mm	170(L) × 105(W) × 48(D)mm
Weight	Approx. 150g	Approx. 260g	Approx. 360g
Accessories	9095(Carrying case) Instruction manual Cable marker		9094(Carrying case) Instruction manual Cable marker
Optional	7146(Banana φ4 adjuster plug) 7185(Extension cable)		
Applicable models	5010, 5020		

# SENSORS

## Leakage current Clamp sensors

MODEL **8141**

MAX 1000mA Ø24



CE

MODEL **8142**

MAX 1000mA Ø40



CE

MODEL **8143**

MAX 1000mA Ø68



CE

	8141	8142	8143
Conductor size	φ24	φ40	φ68
Rated current	AC 1000mA	AC 1000mA	AC 1000mA
Output voltage	AC 100mV/1000mA(AC 100mV/A)		
Accuracy	±1.0%rdg±0.1mV(50/60Hz) ±2.0%rdg±0.1mV(40Hz - 1kHz)		
Cable length : Output connector	Approx. 2m : MINI DIN 6pin		
Operating temperature ranges	-0 - 50°C, less than 85% RH (without condensation)		
Output impedance	Approx. 180Ω	Approx. 200Ω	Approx. 120Ω
Applicable standards	IEC 61010-1, IEC 61010-2-032 CAT III 300V pollution degree 2, IEC 61326		
Dimensions	100(L) × 60(W) × 26(D) mm	128(L) × 81(W) × 36(D) mm	186(L) × 129(W) × 53(D) mm
Weight	Approx. 150g	Approx. 240g	Approx. 490g
Accessories	9095(Carrying case) Instruction manual		9094(Carrying case) Instruction manual
Optional	7146(Banana φ4 adjuster plug) 7185(Extension cable)		
Applicable models	5010, 5020, 6315*		

\*Cannot be used for power measurements.

## AC/DC clamp sensor

KEW **8115**

Ø12 AC MAX 130A DC MAX 180A DC A AUTO POWER OFF



CE

	8115	
Measuring range	AC 0.1 - 130Arms	DC 0 - ±180A
Output voltage	AC 10mV/A	DC 10mV/A
Accuracy	±1.2%rdg±0.4mV (50/60Hz) ±2.5%rdg±0.4mV (40Hz - 1kHz)	±1.2%rdg±0.4mV (*)
Low battery warning	2.2V±0.2V or less - Red LED flash (1.9V±0.2V - Automatically power off)	
Conductor size	φ12mm max.	
Operating temperature & humidity range	-10 to 55°C, relative humidity 85% or less (no condensation)	
Output impedance	Approx. 10Ω or less	
Applicable standards	IEC 61010-1 CAT III 300V Pollution degree 2, IEC 61010-2-032, IEC 61326-1	
Power source	DC3V (size AAA alkaline battery LR03×2pcs) *Continuous use: approx. 40 hours(Auto power off: approx. 20 minutes)	
Cord length	Approx. 1,200mm	
Output connector	φ4mm banana plug	
Dimensions	127(L)×42(W)×22(D) mm	
Weight	Approx. 140g	
Accessories	Soft case, LR03×2, Instruction manual	
Applicable model	1009,1011,1012,1051,1052,1061,1062	





CE

## MODEL 5201

### DIGITAL ILLUMINOMETER

- Model 5201 is a highly portable and compact digital illuminometer for measuring illuminance from 0.1 to 19,990 Lux, with auto range switching.
- The digital display is held for a preset time (about 20 seconds) and, therefore, facilitates reading, recording and measuring in any direction.

	5201
Ranges	0.1 - 19990Lux(automatic 3 range switching)
Accuracy	$\pm 5\%$ rdg $\pm 1$ dgt
Measuring time	2 times per second
Temperature humidity characteristics	$\pm 3\%$ (at 20°C)
Angular incident light characteristics	10° Less than $\pm 1.5\%$ 30° Less than $\pm 3\%$ 60° Less than $\pm 10\%$ 80° Less than $\pm 30\%$
Spectral response characteristics	Closely related to the spectral luminous efficiency (of a standard observer).
Power source	6F22(9V) $\times$ 1
Dimensions	166(L) $\times$ 68(W) $\times$ 32(D)mm
Weight	180g approx.
Accessories	Photocell cover 6F22 $\times$ 1 Soft carrying case Instruction manual



CE

## MODEL 5202

### DIGITAL LIGHT METER

- 3 ranges changeable from low to high illuminance. (200/2000/20000Lux)
- Data hold function.
- Digital light meter with separate light receiving sensor and meter.

	5202		
Ranges	0.1 - 19990Lux		
Accuracy (23°C $\pm$ 5°C)	Lux	Accuracy	
	200	$\pm(4\%$ rdg+5 dgt)	
	2000	$\pm(4\%$ rdg+5 dgt)	
	20000	$\pm(5\%$ rdg+4 dgt)	
Current consumption	2mA approx		
Response time	2.5 times / sec.		
Operating temperature range	0 - 50°C Below 80% RH		
Storage temperature range	-10°C - 60°C		
Angular incident light characteristics	30° Less than $\pm 3\%$	60° Less than $\pm 10\%$	80° Less than $\pm 30\%$
Power source	6F22(9V) $\times$ 1		
Dimensions	Meter:148(L) $\times$ 71(W) $\times$ 36(H)mm Light receiving sensor:85(L) $\times$ 67(W) $\times$ 32(H)mm		
Weight	270g approx.		
Accessories	Carrying case 6F22(9V) $\times$ 1 Photocell cover Instruction manual		



CE

## MODEL 5510

### Waterproof handheld Infrared Thermometer

- Safe even if getting wet. Dustproof and waterproof structure of IP67.
- Possible to wash
- Please feel secure to use the product on the spot, made from ABS resin of antibacterial specification.
- Shock-proof structure: No damage even if dropped from the height of 1m.
- With auto-power-off function, preventing consumption of the battery
- Wide Temperature Range of -40°C to 300°C
- Small and light: Possible to measure easily by one hand.
- Portable type: Convenient to carry

	5510
Measuring range	-40°C - 300°C
Detecting element	Thermopile
Spectral range	6.5 $\mu$ m or more
Display resolution	0.5°C 1°C for below -20°C and over 100°C
Measuring accuracy	When the ambient temperature is 25 $\pm$ 2°C and the emissivity ( $\epsilon$ ) is 1, 0 - 300°C : bigger value of either of $\pm 1\%$ of the measured value $\pm 1$ dgt or $\pm 2^\circ\text{C} \pm 1$ dgt.
	0 - -30°C : $\pm 3^\circ\text{C} \pm 1$ dgt
	below -30°C : $\pm 5^\circ\text{C} \pm 1$ dgt
Repeatability	within 1°C $\pm 1$ dgt
Response	1 sec(90% response)
Measuring diameter	$\phi 45$ mm/500mm(Optical sensitivity: 90%)
Collimation	Before shipment: 0.95. The value can be altered between 0.8 and 1.0 (by 0.05 steps). Laser beam(650nm 1mW JIS class2)specifies the center.
Auto power off	If no key is pressed for 30 seconds, the power is shut off automatically.
Operating temperature	0 - 50°C
Operating humidity	90% rH and below(no condensation)
Storage temperature	-20 - 55°C(no condensation)
Battery	2 AAA alkaline cell batteries
Battery life	Approximately 10 hours for continuous use
Dimensions	120 $\times$ 60 $\times$ 54mm(Maximum value for each direction)
Weight	123g approx.
Accessories	2 AAA alkaline cell batteries, instruction manual, strap
Approved standard	CE marking:EMC EN61326 Class B EMS EN61326 Annex C Stability: $\pm 5^\circ\text{C}$ under EMC test environment at 25°C

### Relation of Distance and Measuring Diameter

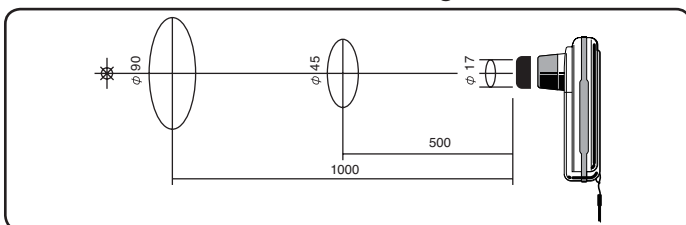

## KEW 8035

Non-Contact Safety Phase Indicator

CAT IV 600V



- New technology permits safe testing, without the need of direct contact between probes and live wires.
- The insulated crocodile clips can clip insulated cables from  $\phi 2.4$  to 30mm.
- Phase rotation is indicated by the rotary illumination of LEDs and logical audible tones.
- The instrument can be fixed to a metal panel via the magnet on the back side.
- Wide measuring range for 3 phase installations from 70V to 1000V AC.
- Super brightness function permits clear LEDs indication also in sunshine.

	8035
Functions	Phase rotation (Clockwise or Counter Clockwise), Presence of open phase
Detection method	Electrostatic induction
Measuring voltage range	From 70 - 1000V AC phase to phase (sine wave, continuous input)
Clamp diameter range	From $\phi 2.4$ to 30mm insulated cables
Measuring frequency range	45 to 66Hz
Phase rotation	Clockwise: Green arrow LEDs "rotate" in clockwise, Green symbol "CW" lits, Intermittent buzzer Counter Clockwise: Red arrow LEDs "rotate" in counter clockwise, Red symbol "CCW" lits, continuous buzzer
Visual indication	Via LEDs with Super brightness function
Battery voltage warning	Power LED blinks if battery voltage is too low.
Operating temperature & humidity range	-10 to 50°C, relative humidity 80% or less (no condensation)
Storage temperature & humidity range	-20 to 60°C, relative humidity 80% or less (no condensation)
Applicable standards	IEC 61010-1 CAT IV 600V, CAT III 1000V Pollution degree 2
Power supply	Alkaline battery (LR6) $\times$ 4 * Continuous use: Approx. 100 hours (Auto power off in about 10 min.)
Dimensions	112(L) $\times$ 61(W) $\times$ 36(D) mm
Weight	380g approx.
Test leads	Double insulated cables, length approx. 70cm
Colours code	L1(U): Red L2(V): White L3(W): Blue
Accessories included	9096 (Carrying case), Alkaline battery (LR6) $\times$ 4, Instruction manual

## MODEL 8030

DIGITAL PHASE INDICATOR with open phase checker



	8030
Operational voltage	200 - 480V AC
Time limit for continuous	200V : within 60 minutes 480V : within 4 minutes
Frequency response	20 - 400Hz
Dimensions continuous	82(L) $\times$ 59(W) $\times$ 23(D)mm 200g approx.
Cord	1m(R: red S: white T: blue)
Accessories	9070(Carrying case) Pins for test leads Instruction manual

- Phase indicator designed to check the presence of open phase and also the phase sequence by LED and buzzer at the same time.
- Small, lightweight, and portable.

## MODEL 8031 / KEW 8031F

PHASE INDICATOR with open phase checker

PHASE INDICATOR with fused test leads



photo : 8031F

- Phase indicator designed to check the presence of open phase and also the phase sequence by rotating disk and lamps.
- Can check a wide range of 3-phase power source from 110V to 600V. Sealed against dust, the unit ensures trouble-free performance.
- Small, Lightweight and portable. Designed for maximum ease of operation and ruggedness.
- No exposed metal parts, Safety features are incorporated including the instant push button switch operation.(8031F Only)

	8031		8031F
	CE Type	Standard Type	
Operational voltage	110 - 600V AC		
Fuse			0.5A/600V (F)
Time limit for continuous	>500V : within 5 minutes		
Frequency response	50/60Hz		
Applicable standards	IEC 61010-1 CAT III 600V Pollution degree 2		IEC 61010-1 CAT III 600V Pollution degree 2
Dimensions	106(L) $\times$ 75(W) $\times$ 40(D)mm		
Weight	350g approx.		
Cord	1.5m(R: red S: white T: blue)		
Accessories	9029(Carrying case) Instruction manual		9094(Carrying case) Instruction manual



MODEL 8031  
CE type



MODEL 8031  
Standard type



CE

## KT 200

### AC CLAMP METER

Ø30 MAX 400A AC A DC AC V Ω ●●)

DATA HOLD AUTO POWER SAVE

- Small and handy clamp meter
- IEC 61010-1 Safety Standard CAT III 300V, CAT II 600V
- 400A AC Clamp meter
- DMM function ACV, DCV, Ω Continuity Buzzer.

KT 200	
AC A	40.00/400.0A ±2.0%rdg±6dgt(50/60Hz)
AC V	400.0/600V(Auto-ranging) ±2.0%rdg±5dgt(50/60Hz)
DC V	400.0/600V(Auto-ranging) ±1.5%rdg±5dgt
Ω	400.0/4000Ω(Auto-ranging) ±2.0%rdg±5dgt
Continuity buzzer	buzzer sounds below 50±35Ω
Conductor size	φ30mm max.
Applicable standards	IEC 61010-1 CAT III 300V(ACA), CAT II 600V Pollution degree 2 IEC 61010-2-032, IEC 61326-1
Power source	R03(1.5V)(AAA) x 2 *Continuous measuring time:approx.200 hours(Auto power save: approx.10 minutes)
Dimensions	184(L) x 68.6(W) x 38.5(D)mm
Weight	Approx. 190g(including batteries)
Accessories	7066A(Test leads), R03(AAA) x 2, Instruction manual
Optional	9105(Carrying case)



CE

## KT 203

### AC/DC CLAMP METER

Ø30 MAX 400A DC AC A DC AC V Ω ●●)

DATA HOLD AUTO POWER SAVE

- Small and handy clamp meter
- IEC 61010-1 Safety Standard CAT III 300V, CAT II 600V
- 400A AC/DC Clamp meter
- DMM function ACV, DCV, Ω Continuity Buzzer.

KT 203	
AC A	40.00/400.0A (Auto-ranging) ±3.0%rdg±8dgt[50/60Hz](0 - 40.00A) ±3.5%rdg±6dgt[50/60Hz](15.0 - 299.9A) ±4.0%rdg±6dgt[50/60Hz](300.0 - 400.0A)
DC A	40.00/400.0A (Auto-ranging) ±3.0%rdg±8dgt (0 - 40.00A) ±3.5%rdg±6dgt (15.0 - 299.9A) ±4.0%rdg±6dgt (300.0 - 400.0A)
AC V	400.0/600V(Auto-ranging) ±2.0%rdg±5dgt(50/60Hz)
DC V	400.0/600V(Auto-ranging) ±1.5%rdg±5dgt
Ω	400.0/4000Ω(Auto-ranging) ±2.0%rdg±5dgt
Continuity buzzer	buzzer sounds below 50±35Ω
Conductor size	φ30mm max.
Applicable standards	IEC 61010-1 CAT III 300V(ACA), CAT II 600V Pollution degree 2 IEC 61010-2-032, IEC 61326-1
Power source	R03(1.5V)(AAA) x 2 *Continuous measuring time:approx.35 hours(Auto power save: approx.10 minutes)
Dimensions	187(L) x 68.5(W) x 38.5(D)mm
Weight	Approx. 200g(including batteries)
Accessories	7066A(Test leads), R03(AAA) x 2, Instruction manual
Optional	9105(Carrying case)



## KT 170/171

VOLTAGE TESTER

CAT IV  
600V



CE

CE

photo : KT170

photo : KT171

Probe Protection Cover



KT170/171	
Voltage test	
Voltage range	12 - 690V AC/DC
LED	
Nominal voltage	12/24/50/120/230/400/690V AC(16 - 400Hz), DC(±)
Tolerance (Threshold voltage)	Light on at more than: 7±3V (12V LED) 18±3V (24V LED) 37.5±4V (50V LED) 75%±5% of nominal voltage (120/230/400/690V LED)
Response time	< 0.6s at 100% of each nominal voltage
LCD (KT171 only)	
Range / Resolution (Auto-range)	300V AC/DC (6.0 - 299.9) / 0.1V 690V AC (270 - 759) / 1V 690V DC (270 - 710) / 1V
Accuracy (23±5°C)	±1.5V (7 - 100V) ±1%±5dgt (100 - 690V) AC(16 - 400Hz), DC(±)
Over limit indication	"OL"
Response time	Approx. 1s at 90% - 100% of each voltage
Peak current	Is<3.5mA (at 690V)
Measurement Duty	30s ON (operation time) 240s OFF (recovery time)
Single-pole phase test	
Voltage range	100 - 690V AC (50/60Hz)
Phase rotation test	
System	Three-phase 4-wire system 200 - 690V phase-to-phase AC (50/60Hz)
Phase range	120±5 degree
Continuity test	
Detection range	0 - 400kΩ + 50%
Test current	Approx. 1.5μA (battery 3V, 0Ω)
Operating temperature and humidity ranges	-15 - 55°C, max 85% RH (No condensation)
Storage temperature and humidity ranges	-20 - 70°C, max 85% RH (No condensation)(KT170) -20 - 60°C, max 85% RH (No condensation)(KT171)
Applicable standards	IEC 61243-3, IEC 61010-1, IEC 61010-031, IEC 61557-7 CAT III 690V / CAT IV 600V Pollution degree 2, IEC 60529 (IP65)
Power source	LR03(AAA) 1.5V x 2
Dimensions	246 x 64 x 26mm
Weight	195g (including batteries)
Accessories	LR03(AAA) 1.5V x 2, KTA01(4mm metal tips[2pcs/set]), KTA02(4mm rubber caps[2pcs/set]), Instruction manual

KT170AU is available for Australia and New Zealand market.

- Comply with the latest standards IEC 61243 and IEC 61010
- Novel design  
Large and bright LEDs: Values are visible in the dark place.  
Ergonomic design fits in the hand.
- Two functions are available in one model.  
"Measurement without battery" and "Self Test (all LED on)"
- Test leads withstand harsh environments at low temperature.
- Penlight(white LED)
- Auto-power ON / OFF
- Audible indication
- Variable test tips, φ2mm or φ4mm
- Probe protection cover can store the attachment of caps.
- IP65 (IEC 60529)

### Variable top tips

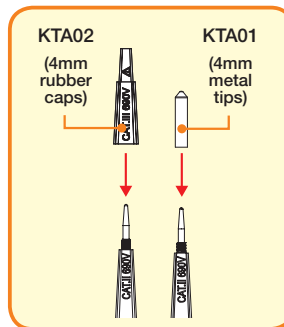

### Store the attachment of caps

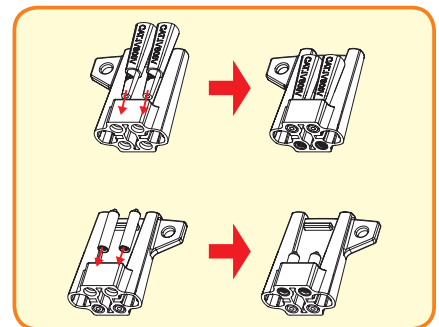

### Voltage Test (Double-pole Test)

- The voltage is indicated by LEDs.
- Buzzer sounds and Live circuit LED lights up when a threshold voltage of 50V is exceeded.
- Voltage polarity is indicated in following manner.



AC +DC -DC  
+12 -12 -12

### Bright LEDs and Penlight



### Single-pole Phase Test



# ACCESSORIES

## 7025 1,500mm



Applicable model

3165  
3166

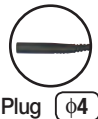

## 7060 1,200mm

\*Temperature probe



Applicable model

1110  
2608A



## 7066A 1,100mm



Applicable model

1009 2040  
1011 2046R  
1012 2055  
1021R 2056R  
1110 2412  
2007A 2608A  
2017 KT200  
2027 KT203



## 7073 2,120mm

\*2WAY Output cord

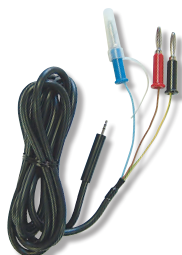

Applicable model

2413F  
2413R



## 7082 1,100mm

\*Lead for recorder



Applicable model

3124



## 7083 5,200mm

\*Lead for battery charging



Applicable model

3124

## 7084 5,000mm

\*Earth and guard leads



Applicable model

3124

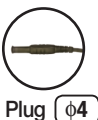

## 7095A

\*Earth resistance test leads



Applicable model

4102A  
4105A  
6018

Green: 5m  
Yellow: 10m  
Red: 20m



## 7100A

Consists of :  
7095A(Earth resistance test leads)  
8032(Auxiliary earth spikes)  
8200-03(Cord reels (3pcs))  
9091(Carrying case for cord reels)



Applicable model

4102A  
4105A  
6018

Green: 5m  
Yellow: 10m  
Red: 20m



## 7103A/7139A Line 1,000mm Earth 1,550mm

\*Test leads with remote control switch



photo : 7103A

Applicable model

**7103A** **7139A**  
3021 3161A  
3022  
3023  
6018

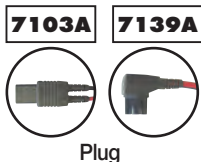

## 7107A 1,100mm



Applicable model

2002PA  
2002R  
2003A  
2009R  
2200  
2200R



## 7115/7116 1,000mm

\*Extension probe



photo : 7115

Applicable model

**7115** **7116**  
3021 3161A  
3022  
3023  
6018

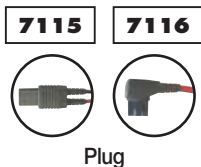

## 7121B 1,500mm

\*Distribution board test leads



Applicable model

4118A  
5406A  
6201A



# ACCESSORIES

## 7122B 1,220mm



**Applicable model**  
3005A 6010B  
3007A 6011A  
3131A  
3132A



## 7123/7124/7125/7126 1,500mm

\*Molded plug test lead

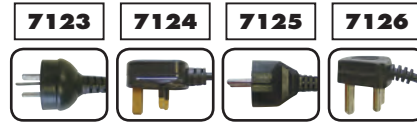

Plug

7123 : (AU) Australian plug  
7124 : (UK) British plug (13A)

7125 : (EU) European SHUKO plug  
7126 : (SA) South african plug

**Applicable model**  
4118A  
5406A  
**7123 (AU)**  
6201A

## 7127A 1,570mm

\*Simplified measurement probe



**Applicable model**  
4102A  
4105A



## 7128A 1,390mm



**Applicable model**  
5410



## 7129A 1,450mm



**Applicable model**  
5410  
6201A

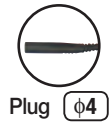

## 7132A 1,200mm (KSLP5)



**Applicable model**  
6011A



## 7133B 1,500mm (OMA DIEC)



**Applicable model**  
6010B  
6011A

## 7141B 3,000mm

\*Voltage test lead set



**Applicable model**  
6305  
6315

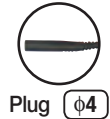

## 7146 190mm

\*Banana  $\phi 4$  adjuster plug



**Applicable model**  
8121 8128  
8122 8141  
8123 8142  
8124 8143  
8125 8146  
8126 8147  
8127 8148



## 7149A/7150A Line 1,000mm Earth 1,550mm

\*Test leads with remote control switch set



(7103A or 7139A, 7161A, 7131B, 8017,  
9120 or 9041)

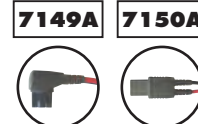

Plug  $\phi 4$

**Applicable model**  
**7149A** **7150A**  
3161A 3021  
3022  
3023

## 7153B 1,220mm

\*Safety test leads



**Applicable model**  
1009 2040  
1011 2046R  
1012 2055  
1021R 2056R  
1110 2412  
2017 2608A  
2027



## 7154B 1,220mm

\*Safety test leads



**Applicable model**  
1009 2055  
1011 2056R  
1012 2412  
1021R 2608A  
1110 3165  
2017 3166  
2027 6010B  
2040 6011A  
2046R 6016



## 7155B



**Applicable model**  
7153B  
7154B



# ACCESSORIES

## 7156B 1,220mm

\*Safety test leads with fuse



Applicable model

- 1009 2055
- 1011 2056R
- 1012 2412
- 1021R 2608A
- 1110 3165
- 2017 3166
- 2027 6010B
- 2040 6011A
- 2046R 6016

## 7157B



Applicable model

- 7153B
- 7154B

## 7158B



Applicable model

- 7155B
- 7156B

## 7159B 1,220mm

\*Safety test leads with fuse



Applicable model

- 1009 2055
- 1011 2056R
- 1021R 2412
- 1112 2608A
- 1110 3165
- 2017 3166
- 2027 6010B
- 2040 6011A
- 2046R 6016

## 7165A 3,000mm

\*Line probe



Applicable model

- 3025A
- 3121B
- 3122B
- 3123A
- 3125A
- 3126
- 3127

## 7168A 3,000mm

\*Line probe with alligator clip



Applicable model

- 3025A
- 3121B
- 3122B
- 3123A
- 3125A
- 3126
- 3127

## 7170 2,000mm

\*Power cord



Applicable model

- 3128
- 6305
- 6315

## 7185 3,000mm

\*Extension cable



Applicable model

- 5010 8128
- 5020 8141
- 8121 8142
- 8122 8143
- 8123 8146
- 8124 8147
- 8125 8148
- 8126
- 8127

## 7188A 1,520mm

\*Distribution board fused test leads



Applicable model

- 6016



## 7196A 1,550mm

\*Test leads with remote control switch



Applicable model

- 6016

## 7199 1,000mm

\*Output cable



Applicable model

- 8129

## 7210A 1,040mm



Applicable model

- 1109S



## 7187A/7218A/7221A/7222A 1,230mm

\*Main test lead



photo : 7218A

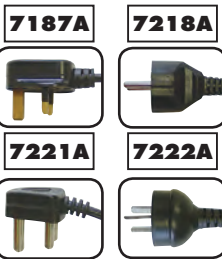

Applicable model

- 4140
- 6016

7187A : UK plug  
7218A : EU plug  
7221A : SA plug  
7222A : AU plug

## 7219 1,950mm

Applicable model

- 6315



# ACCESSORIES

## 7220A 1,080mm



Applicable model

1051  
1052  
1061  
1062



Plug  $\phi 4$

## 7224A 1,500mm

\*Earth cord



Applicable model

3123A  
3126  
3127  
3128

## 7225A 1,500mm

\*Guard cord



Applicable model

3123A  
3126  
3127  
3128

## 7226A 3,000mm

\*Line probe



Applicable model

3128

## 7227A 3,000mm

\*Line probe with alligator clip



Applicable model

3128

## 7228A

\*Earth resistance test leads



Applicable model

6016

Green : 5m  
Yellow : 10m  
Red : 20m



Plug  $\phi 4$

## 7229A

\*Earth resistance test leads



Applicable model

4106

Green : 20m  
Yellow : 20m  
Black : 20m  
Red : 40m



Plug  $\phi 4$

## 7234 1,080mm

\*Alligator clip



Applicable model

1009 1051  
1011 1052  
1012 1061  
1021R 1062



Plug  $\phi 4$

## 7238A 1,570mm

\*Simplified measurement test leads



Applicable model

4106



Plug  $\phi 4$

## 7246/7247 1,400mm

\*Distribution board test lead



Plug  $\phi 4$

Applicable model

4140

**7246**

Blue, Green, Red

**7247**

Black, Green, Red

photo : 7246

## 7248 2,000mm



Applicable model

4300



Plug  $\phi 4$

## 7253/7254 15m

\*Longer line probe with alligator clip



Applicable model

**7253**

3121B 3125A  
3122B 3126  
3123A 3127  
3025A

**7254**

3128

photo : 7253

## 7256 1,200mm

\*Out put cord



Applicable model

2002PA 2010  
2002R 2412  
2003A 2500  
2009R



Plug  $\phi 4$

## 7264 3,000mm

\*Earth cord



Applicable model

3025A  
3121B  
3122B  
3125A

# ACCESSORIES

## 7265 3,000mm

\*Guard cord



Applicable model

3025A  
3121B  
3122B  
3125A

## 8216 1,000mm

\*Temperature probe



Applicable model

1011  
2046R  
2056R

## 8405 1,400mm

\*Temperature probe



Applicable model

1051  
1052  
1061  
1062

• Max. 500°C, Surface type,  
Point material: Ceramic



Plug  $\phi 4$

## 8406 1,380mm

\*Temperature probe



Applicable model

1051  
1052  
1061  
1062

• Max. 500°C, Surface type



Plug  $\phi 4$

## 8407 1,540mm

\*Temperature probe



Applicable model

1051  
1052  
1061  
1062

• Max. 700°C, Liquid,  
Semi-solid



Plug  $\phi 4$

## 8408 1,540mm

\*Temperature probe



Applicable model

1051  
1052  
1061  
1062

• Max. 600°C, Air, Gas



Plug  $\phi 4$

## KAMP10 1,500mm

\*Test lead with IEC connector

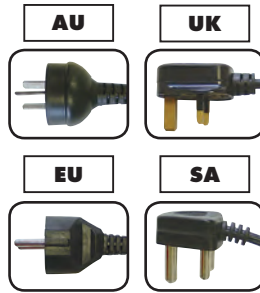

Plug

Applicable model

6010B  
6011A

AU : Australian plug  
UK : British plug (13A)  
EU : European SHUKO plug  
SA : South african plug



# ACCESSORIES

## 8901

Fuse [0.5A/250V]

**Applicable model**  
1109S



## 8918

Ceramic fuse [0.8A/600V]

**Applicable model**  
1011  
1012



## 8919

Ceramic fuse [10A/600V]

**Applicable model**  
1009  
1011  
1012  
1021R



## 8923

Fuse [0.5A/600V]

**Applicable model**  
1009  
1110  
2608A  
3005A  
3007A  
3021  
3022  
3023  
3131A  
3132A  
8312



## 8926

Fuse [440mA/1000V]

**Applicable model**  
1051  
1052  
1061  
1062



## 8927

Fuse [10A/1000V]

**Applicable model**  
1051  
1052  
1061  
1062



## Accuracy

The accuracy of a digital tester is defined as the difference between the reading and the true value for a quantity measured in reference conditions. Accuracy is specified in the format: ( $\pm xx\%$  rdg  $\pm xx$  dgt)

The first portion identifies a percentage error relative to the reading, which means it is proportional to the input. The second portion is an error, in digits, that is constant regardless of the input.

"Rdg" is for reading and "dgt" is for digits. Dgt indicates the counts on the last significant digit of the digital display and is typically used to represent an error factor of a digital tester.

## Auto-discharge Function

A function used immediately after an insulation test to automatically release charges stored within the circuit under test during measurement.

Voltage remaining in the circuit under test can be monitored during auto-discharging process as the scale reading.

## Auto-ranging

A function of a tester to automatically select the appropriate measuring range based on the input signal.

## Average Value

The average of an AC waveform's instantaneous values taken over a half cycle. Ordinary testers respond to the average value.

### For sinusoidal wave :

Average value = Maximum value  $\times 2/\pi$  = Maximum value  $\times 0.637$

### When the true RMS value is 100V ;

Average value = Maximum value  $\times 2/\pi$  =  $141 \times 0.637 = 90(V)$

The reading of ordinary testers is calibrated in terms of the effective value of a sinusoidal wave even though they are responding to the average value. They are called average-responding-RMS-calibrated type of testers. As opposed to these, true-RMS type testers respond and show the true RMS value.

## Crest Factor

The ratio of the maximum value to the effective value.

It represents the range of input in which a tester maintains linear operation, expressed by a multiple of the full scale value of the range being used.

Crest factor = Maximum value / True RMS value

For sinusoidal wave;

Crest factor =  $141/100 = 1.41$

## Data Hold

A function to freeze the reading on a digital display for ease of checking or recording even in a difficult-to-read situation for a tester.

## Decibel: dB

A unit used to express the magnitude of change in level of electric signal or sound intensity.

A voltage ratio of 1 to 10 is equal to -20dB, 10 to 1 to 20dB, 100 to 1 to 40dB and 1000 to 1 to 60dB. A power ratio of 10 to 1 is not 20dB, but 10dB, since power(P) is proportional to the square of voltage(V).

## Diode Test

A function to apply a diode or a transistor a constant current having a value needed to turn it on in order to check the diode's or the transistor's forward voltage drop and identifying the connection direction of the device.

## Distortion Factor

A degree of distortion of a waveform, typically expressed as the ratio of the effective value of harmonic components to the effective value of the fundamental component.

## Dual Integration Method

A technique to convert voltage into time. The first integration time (Ts) and the second integration time (Tx) are used. First, the input voltage (Vx) is integrated on a certain time interval (Ts) and then, the resulting voltage is "reverse-integrated" using a reference voltage (Vr) until it becomes 0 (zero).

The "reverse-integration time" (Tx) is proportional to input voltage (Vx). Therefore, the input voltage (Vx) can be determined by measuring Tx.

With this technique, stable measurements can be taken with high accuracy, resolution and noise rejection ratio. One particular advantage is high noise rejection ratio at 50 or 60Hz power line frequency. All of Kyoritsu digital clamp meters and testers utilize this method.

## Effective Measuring Range of Insulation Tester

The measuring range for which the accuracy of an insulation tester is guaranteed. There are two kinds of effective measuring ranges: the first and second effective measuring ranges.

### First effective measuring range

From 1/1000 to 1/2 the maximum effective scale value (When there is no major scale division for 1/2 the maximum effective scale value, the nearest major scale division is used.)

### Second effective measuring range

Scales divisions not included in the first effective measuring range

For example for a 500V/100M $\Omega$  insulation tester;

First effective measuring range: 0.1-50M $\Omega$ ( $\pm 5\%$  of indicated value)

Second effective measuring range: 50-100M $\Omega$ ( $\pm 10\%$  of indicated value)

## Form Factor

The ratio of the effective value to the average value.

Form factor = Effective value / Average value

## Frequency Response

The manner in which a device changes its output quantity it, its indication for a measured quantity or its response over a range of frequencies.

AC signals to measure with a tester can be of one frequency or from a wide frequency band ranging from low to high frequencies. To measure these frequencies, it is better to use a tester having a wide frequency response range.

## Hall Element

When a current-carrying conductor is placed in a magnetic field so that the direction of the magnetic field is perpendicular

# GLOSSARY

to the direction of the current flow, voltage is developed in the direction perpendicular to both the magnetic field and the current flow. This is called the Hall effect and the Hall element is a device that utilizes the effect.

Kyoritsu AC/DC clamp meters and clamp sensors employ the Hall element.

## Harmonics

Power line AC voltage from a utility company has near sinusoidal waveform of fundamental frequency with little distortion. When only a load consisting of resistors, capacitors and coils, called a linear load (its constant is fixed regardless of the amount of current flowing through it), is connected to mains supply, no distortion is introduced into the load current waveform. However, when a non-linear load, such as a semiconductor and a saturable reactor, is connected, distortion appears in the load current waveform. The current with a waveform containing distortion, or harmonic current, flows in the direction toward the low impedance side and in the process, produces voltage drop over the impedance of the current path, causing the load voltage also to contain harmonics.

## Indicated Value

The value indicated by a tester for a measured quantity

## Peak Hold

A function to memorize the peak value over a certain period of time.

\*Response time is selectable from approx. 10ms and 100ms.

Reading in the peak hold mode is the peak current value multiplies by  $1/\sqrt{2}$ .

(When the input is sinusoidal, the reading is equal to the true RMS value.)

## Peak Value

The value at a point where a waveform has the maximum amplitude.

## Resolution

The minimum increments in which a tester can take measurements.

## Sample Rate

Frequency at which an A/D converter circuit senses the quantity to measure: typically, twice or three times per second.

## Sensitivity

The ability of a tester to respond to the quantity to measure, expressed as the ratio of a change induced in the reading to a change in the input:

$$\text{Sensitivity} = \frac{\text{Change in reading}}{\text{Change in quantity to measure}}$$

## Shock Hazard

Also referred to as electric shock. When a person touches a motor that has a "leak", a path can be created from the motor frame to the hand, body and feet of the person to the floor he is standing on to allow a current to flow through it, sometimes resulting in a fatal accident.

The seriousness of a shock hazard widely varies depending on the amount and duration of the current that flows through the person's body. His constitution, age and medical condition are also variation factors, but in general, at a frequency of 50 or 60Hz, stimulus to the skin is felt at 1mA, considerable pain occurs at 5mA, pain is unbearable at 10mA, there is difficulty in releasing the "leaking" object because of intense muscle contraction at 20mA, it is considerably dangerous at 50mA and fatality is likely at 100mA. For the safety limit for a fatal current, which causes ventricular fibrillation, Professor Dalziel proposed the following equation from numbers of experiments on animals.

$$I = 165 \sqrt{t}$$

Where, I = current (mA) and t = time (sec).

From this theory, the maximum duration for a current of 165mA is 1 second.

## Thermocouple

A device that uses the voltage developed by the junction of two dissimilar metals to measure temperature. One junction, called the measuring junction, is placed at the point where temperature is to be measured. The other junction, called the reference junction, is maintained at a reference temperature. The voltage developed between the two junctions varies depending on the difference between the temperatures of the two junctions and the type of thermocouple.

## True RMS Value

The square root of the average of the square of a periodic waveform's instantaneous values taken over one cycle. It is also called the rms value and the most closely relates to such form of energy as force and heat.

(The effective value of an alternating current is expressed as the value of the direct current which produces the same amount of heat as the alternation current does.)

For sinusoidal wave :

$$\text{True RMS} = \text{Maximum value} \times 1/\sqrt{2} = \text{Maximum value} \times 0.707$$

When a True RMS is 100V ;

$$\text{Maximum value} = \text{True RMS} \times \sqrt{2} = 100 \times 1.41 = 141(\text{V})$$

## Measurement categories (Over-voltage categories)

To ensure safe operation of measuring instruments, IEC 61010 establishes safety standards for various electrical environments, categorized as O to CAT IV, and called measurement categories. Higher-numbered categories correspond to electrical environments with greater momentary energy, so a measuring instrument designed for CAT III environments can endure greater momentary energy than one designed for CAT II.

O : Circuits which are not directly connected to the mains power supply.

CAT II : Electrical circuits of equipment connected to an AC electrical outlet by a power cord.

CAT III : Primary electrical circuits of the equipment connected directly to the distribution panel, and feeders from the distribution panel to outlets.

CAT IV : The circuit from the service drop to the service entrance, and to the power meter and primary overcurrent protection device (distribution panel).

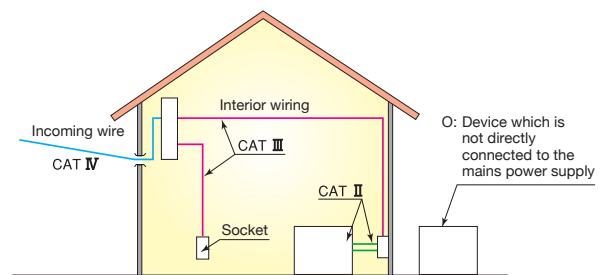



# PRODUCT INDEX

## 1000

1009	Digital Multimeter	11
1011	Digital Multimeter	11
1012	Digital Multimeter	11
1018	Digital Multimeter (Soft case type)	12
1018H	Digital Multimeter (Hard case type)	12
1019R	Digital Multimeter	12
1021R	Digital Multimeter	10
1030	Digital Multimeter (Pen type)	12
1051	Digital Multimeter	14
1052	Digital Multimeter	14
1061	Digital Multimeter	14
1062	Digital Multimeter	14
1109S	Analogue Multimeter	11
1110	Analogue Multimeter	11

## 2000

2000	Digital Multimeter	13
2001	Digital Multimeter	13
2002PA	Digital Clamp Meter	19
2002R	Digital Clamp Meter	19
2003A	Digital Clamp Meter	22
2007A	Digital Clamp Meter	19
2009R	Digital Clamp Meter	22
2010	Digital Clamp Meter	22
2012R	Digital Multimeter	13
2017	Digital Clamp Meter	20
2027	Digital Clamp Meter	20
2031	Digital Clamp Meter	20
2033	Digital Clamp Meter	23
2040	Digital Clamp Meter	21
2046R	Digital Clamp Meter	23
2055	Digital Clamp Meter	23
2056R	Digital Clamp Meter	23
2200	Digital Clamp Meter	21
2200R	Digital Clamp Meter	21
2210R	Digital Clamp Meter	21
2300R	Fork Current Tester	24
2412	Leakage Clamp Meter	26
2413F	Leakage Clamp Meter	26
2413R	Leakage Clamp Meter	26
2431	Leakage Clamp Meter	25
2432	Leakage Clamp Meter	25
2433	Leakage Clamp Meter	25
2433R	Leakage Clamp Meter	25
2434	Leakage Clamp Meter	26
2500	DC Milliamp Clamp Meter	24
2608A	Analogue Clamp Meter	19

## 3000

3005A	Digital Insulation/Continuity Tester	30
3007A	Digital Insulation/Continuity Tester	30
3021	Digital Insulation/Continuity Tester	31
3022	Digital Insulation/Continuity Tester	31
3023	Digital Insulation/Continuity Tester	31
3131A	Analogue Insulation/Continuity Tester	32
3132A	Analogue Insulation/Continuity Tester	32
3161A	Analogue Insulation/Continuity Tester	33
3165	Analogue Insulation Tester	33
3166	Analogue Insulation Tester	33
3025A	High Voltage Insulation Tester	39
3121B	High Voltage Insulation Tester	38
3122B	High Voltage Insulation Tester	38
3123A	High Voltage Insulation Tester	36
3124	High Voltage Insulation Tester	37

3125A	High Voltage Insulation Tester	39
3126	High Voltage Insulation Tester	39
3127	High Voltage Insulation Tester	35
3128	High Voltage Insulation Tester	34

## 4000

4102A	Earth Tester (Soft case model)	41
4102A-H	Earth Tester (Hard case model)	41
4105A	Earth Tester (Soft case model)	41
4105A-H	Earth Tester (Hard case model)	41
4106	Earth Tester	42
4200	Earth Clamp Tester	43
4202	Earth Clamp Tester	43
4300	Simplified Earth Tester	42
4118A	LOOP/PSC Tester	44
4140	LOOP/PFC/PSC Tester	45

## 5000

5010	AC Current Logger	60
5020	AC Current/Voltage Logger	60
5201	Digital Illuminometer	66
5202	Digital Light Meter	66
5406A	RCD Tester	46
5410	RCD Tester	47
5510	Infrared Thermometer	66

## 6000

6010B	Multi Function Tester	50
6011A	Multi Function Tester	51
6016	Multi Function Tester	52
6018	Multi Function Tester	49
6201A	Portable Appliance Tester	48
6305	Power Meter	58
6305-01	6305+8125x3+9125	59
6305-03	6305+8130x3+9135	59
6315	Power Meter	56
6315-01	6315+8125x3+9125	57
6315-03	6315+8130x3+9135	57

## 7000

7025	Test leads	33,70
7060	Temperature probe	11,19,70
7066A	Test leads	10,11,19-21,23,26,68,70
7073	2WAY Output cord	26,70
7082	Leads for recorder	37,70
7083	Leads for battery charging	37,70
7084	Earth and guard leads	37,70
7095A	Earth resistance test leads	41,49,70
7100A	Precision measurement cord set	41,49,70
7103A	Test leads with remote control switch	31,49,70,71
7107A	Test leads	19,21,22,70
7115	Extension probe	31,49,70
7116	Extension probe	33,70
7121B	Distribution board test leads	44,46,48,70
7122B	Test leads	30,32,50,51,71
7123	Molded plug test lead [AU]	44,46,48,71
7124	Molded plug test lead [UK]	44,46,71
7125	Molded plug test lead [EU]	44,46,71
7126	Molded plug test lead [SA]	44,46,71
7127A	Simplified measurement probe	41,71
7128A	Test leads	47,71
7129A	Test lead with alligator clip	47,48,71
7131B	Safety crocodile clip [black]	31,33,49,71
7132A(KSLP5)	External earth probe	51,71
7133B(OMA DIEC)	Distribution board test leads	50,51,71

# PRODUCT INDEX

<b>7139A</b>	Test leads with remote control switch	33,70,71
<b>7140</b>	Adaptor for extension cord	48
<b>7141B</b>	Voltage test lead set	56-59,71
<b>7146</b>	Banana $\phi$ 4 adjuster plug	15,63-65,71
<b>7148</b>	USB cable	58-61
<b>7149A</b>	Test leads with remote control switch set	33,71
<b>7150A</b>	Test leads with remote control switch set	31,71
<b>7153B</b>	Safety test leads	71
<b>7154B</b>	Safety test leads	71
<b>7155B</b>	Safety test leads with fuse	71
<b>7156B</b>	Safety test leads with fuse	72
<b>7157B</b>	Safety crocodile clips	72
<b>7158B</b>	Safety crocodile clips for fuse	72
<b>7159B</b>	Safety test leads with fuse	72
<b>7161A</b>	Flat test prod [black]	31,33,48,49,71
<b>7165A</b>	Line probe	35,36,38,39,72
<b>7168A</b>	Line probe with alligator clip	35,36,38,39,72
<b>7170</b>	Power cord	34,56-59,72
<b>7185</b>	Extension cable	60,63-65,72
<b>7187A</b>	Main test lead [UK]	45,53,72
<b>7188A</b>	Distribution board fused test leads	53,72
<b>7196A</b>	Test leads with remote control switch	53,72
<b>7199</b>	Output cable	63,72
<b>7210A</b>	Test leads	11,72
<b>7218A</b>	Main test lead [EU]	45,53,72
<b>7219</b>	USB cable	56, 72
<b>7220A</b>	Test leads	14,73
<b>7221A</b>	Main test lead [SA]	45,53,72
<b>7222A</b>	Main test lead [AU]	45,53,72
<b>7224A</b>	Earth cord	34-36,39,73
<b>7225A</b>	Guard cord	34-36,39,73
<b>7226A</b>	Line probe	34,73
<b>7227A</b>	Line probe with alligator clip	34,73
<b>7228A</b>	Earth resistance test leads	53,73
<b>7229A</b>	Earth resistance test leads	42,73
<b>7234</b>	Alligator clip	10,11,15,73
<b>7238A</b>	Simplified measurement test leads	42,73
<b>7246</b>	Distribution board test lead	45,73
<b>7247</b>	Distribution board test lead	45,73
<b>7248</b>	Test leads	42,73
<b>7253</b>	Longer line probe with alligator clip	35,36,38,39,73
<b>7254</b>	Longer line probe with alligator clip	34,73
<b>7256</b>	Output cord	19,22,24,26,73
<b>7264</b>	Earth cord	38,39,73
<b>7265</b>	Guard cord	38,39,74

## 8000

<b>8008</b>	Multi-Tran	19-23,25-27
<b>8016</b>	Hook type prod	31,33,49
<b>8017</b>	Extension prod	31,33,42,47,49,71
<b>8019</b>	Hook type prod	35,36,38,39
<b>8022</b>	AC adaptor [110V]	22,26
<b>8023</b>	AC adaptor [220V]	22,26
<b>8025</b>	Output plug	26
<b>8029</b>	Extension prod	34
<b>8030</b>	Phase indicator	67
<b>8031</b>	Phase indicator	67
<b>8031F</b>	Phase indicator	67
<b>8032</b>	Auxiliary earth spikes [2 spikes/set] x 1set	41,42,49,53,70
<b>8035</b>	Non-contact Phase Indicator	67
<b>8072</b>	CAT II Standard prod	42
<b>8075</b>	Battery charger [120V]	37
<b>8080</b>	Battery charger [220V]	37
<b>8112</b>	AC Clamp Adaptor	27
<b>8112BNC</b>	AC Clamp Adaptor	27

<b>8115</b>	Clamp Sensor	10,15,27,65
<b>8121</b>	Load current Clamp Sensor	15,60,62,64
<b>8122</b>	Load current Clamp Sensor	15,60,62,64
<b>8123</b>	Load current Clamp Sensor	15,60,62,64
<b>8124</b>	Load current Clamp Sensor	56-59,62,63
<b>8125</b>	Load current Clamp Sensor	56-59,62,63
<b>8126</b>	Load current Clamp Sensor	56-59,62,63
<b>8127</b>	Load current Clamp Sensor	56-59,62,63
<b>8128</b>	Load current Clamp Sensor	56-59,62,63
<b>8129</b>	Flexible Clamp Sensor	56-60,62,63
<b>8130</b>	Flexible Clamp Sensor	56-59,62,63
<b>8141</b>	Leakage current Clamp Sensor	62,65
<b>8142</b>	Leakage current Clamp Sensor	62,65
<b>8143</b>	Leakage current Clamp Sensor	62,65
<b>8146</b>	Leakage & Load current Clamp Sensor	15,56,57,60,62,64
<b>8147</b>	Leakage & Load current Clamp Sensor	15,56,57,60,62,64
<b>8148</b>	Leakage & Load current Clamp Sensor	15,56,57,60,62,64
<b>8161</b>	Clamp Sensor	10
<b>8200-03</b>	Cord reel [3pcs]	41,49,70
<b>8200-04</b>	Cord reel [4pcs]	42
<b>8201</b>	Output plug	19,22
<b>8212-RS232C</b>	RS232C adaptor with "KEW Report[Software]"	42,50,53
<b>8212-USB</b>	USB adaptor with "KEW Report[Software]"	42,50,53
<b>8212-USB-W</b>	USB adaptor with "KEW Windows[Software]"	34
<b>8216</b>	Temperature probe	11,23,74
<b>8241</b>	USB Communication set	15
<b>8243</b>	Printer Communication set	15
<b>8246</b>	Printer	15
<b>8247</b>	Thermal paper for printer	15
<b>8248</b>	AC adapter for printer [EU]	15
<b>8249</b>	DMM printer full set	15
<b>8253</b>	CAT III Standard prod	42
<b>8255</b>	CAT IV Standard prod	34
<b>8258</b>	USB communication set	35
<b>8302</b>	Adaptor for recorder	35,38,39
<b>8304</b>	Resister for operation check	43
<b>8309</b>	Voltage sensor	60,62
<b>8312</b>	Power supply adaptor	56-59,62
<b>8320</b>	AC adaptor	60,62
<b>8324</b>	Adaptor for recorder	36
<b>8326-02</b>	SD card [2GB]	56,58
<b>8327EU</b>	Power adaptor 15V/1A	35
<b>8405</b>	Temperature probe	15,74
<b>8406</b>	Temperature probe	15,74
<b>8407</b>	Temperature probe	15,74
<b>8408</b>	Temperature probe	15,74
<b>8901</b>	Fuse [0.5A/250V]	11,75
<b>8918</b>	Ceramic fuse [0.8A/600V]	11,75
<b>8919</b>	Ceramic fuse [10A/600V]	10,11,75
<b>8923</b>	Fuse [F500mA/600V]	11,19,30-32,59,62,75
<b>8926</b>	Fuse [440mA/1000V]	14,75
<b>8927</b>	Fuse [10A/1000V]	14,75

## 9000

<b>9029</b>	Carrying case	67
<b>9041</b>	Cord case	33,71
<b>9056</b>	Carrying case	27
<b>9057</b>	Carrying case	27
<b>9070</b>	Carrying case	67
<b>9071</b>	Carrying case	22
<b>9072</b>	Carrying case	26
<b>9074</b>	Cord case	30,32,33
<b>9079</b>	Carrying case	20
<b>9084</b>	Soft case	41
<b>9089</b>	Carrying case	31

# PRODUCT INDEX

9090	Carrying case	20,23,25
9091	Carrying case for cord reels	41,49,70
9092	Cord case	49-51
9094	Carrying case	19,21-23,26,63-65,67
9095	Carrying case	63-65
9096	Carrying case	24,67
9097	Carrying case	10,19,25,26
9103	Carrying case	11
9107	Soft case	13
9113	Carrying case	24
9114	Carrying case [Hard]	12
9115	Carrying case [Soft]	12
9118	Carrying case [Soft]	60
9120	Cord case	31,71
9121	Shoulder strap	30-32,41,42,44,46-49,51,53
9123	Shoulder strap	33
9125	Carrying case	42,56-59
9130	Carrying case	12
9132	Carrying case with magnet	57-59,62
9135	Carrying case	57,59,60,62
9137	Carrying case	63
9142	Carrying case	53
9147	Cord case	44,46-48
9148	Shoulder strap	50
9154	Carrying case	15
9155	Shoulder strap	45
9156	Soft case	45
9158	Carrying case [Hard]	36
9160	Carrying case	21
9161	Carrying case	42
9164	Carrying case [Hard]	41
9165	Carrying case [Hard]	41
9166	Carrying case [Hard]	43
9167	Carrying case [Hard]	43
9168	Carrying case	11
9171	Carrying case [Hard]	35
9174	Carrying case	21
9176	Carrying case [Hard]	37
9180	Carrying case [Hard]	39
9181	Carrying case [Hard]	39
9182	Carrying case [Hard]	38
9183	Carrying case [Hard]	38
9188	Hard case	12
9189	Magnet hanger strap	10
<b>KAMP10</b>	Test lead with IEC connector	50,51,74
<b>KT170</b>	Voltage Tester	69
<b>KT171</b>	Voltage Tester	69
<b>KT200</b>	Digital Clamp Meter	68
<b>KT203</b>	Digital Clamp Meter	68
<b>Ni-Cd rechargeable battery</b>		37



# QUALITY CONTROL CONCEPT

Kyoritsu started early an effort to establish system that ensures traceability to the national standards in order to produce reliable instruments as well as instruments that can assure reliability of other equipment and installations.

When traceability is in place, measurements taken with an instrument any time and anywhere in any situation can be related to the appropriate national measurement standards through a clear and unbroken chain of comparisons.

For example, in terms on measurement defined by JIS (Japanese Industrial Standards), traceability is specified as a condition in which a calibration path is established from instruments produced or in-house standards to higher level standards to the national standards. Kyoritsu currently has a system in place as shown in the figure below.

Our calibrator (standard) is calibrated at Japan Electric Meters Inspection Corporation (JEMIC), Japan Quality Assurance Organization (JQA) and Fluke Japan who perform calibration based on the units established and maintained by National Institute of Advanced Industrial Science and Technology (AIST). The standard is used as the in-house standard to calibrate all the test and measuring equipments which are used in-house.

Voltage : Precision calibrators are used as in-house DC and AC voltage standards.

Current : DC or AC current is converted to a voltage by a standard resistor, and the voltage is calibrated with a precision digital multimeter.

Resistance : Calibration resistors are calibrated with a DC standard current generator and the precision digital multimeter.

## Calibration System for Electrical Measuring Instruments

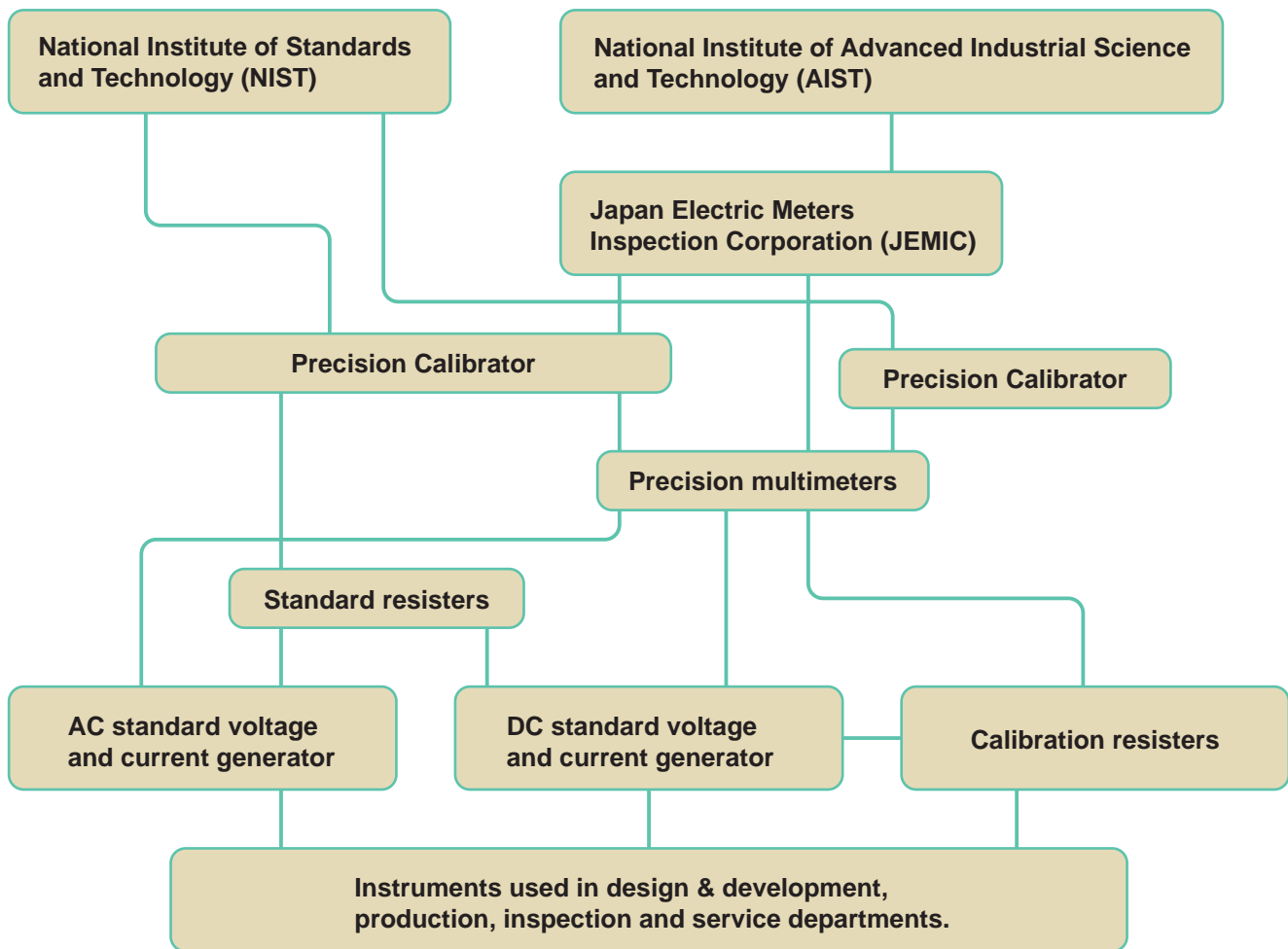

CE Marking: signifies conformance to  
EMC directive (2004/108/EU)  
LVD directive (2006/95/EU)  
RoHs directive (2011/65/EU)

## KYORITSU GLOBAL NETWORK



- Headquarters
- Affiliates

### ● **KYORITSU ELECTRICAL INSTRUMENTS WORKS, LTD.**

No.5-20, Nakane 2-chome,  
Meguro-ku, Tokyo, 152-0031 Japan  
Phone: +81-3-3723-0131  
FAX: +81-3-3723-0152  
URL: <http://www.kew-ltd.co.jp>  
E-mail: [info-eng@kew-ltd.co.jp](mailto:info-eng@kew-ltd.co.jp)  
Factory: Ehime

### ● **Kew Europe Office**

Viale Rimembranze 93/18,  
20099 Sesto S. Giovanni (MI) Italy  
Phone: +39-02-38238685

### ● **Kew (Thailand) Ltd.**

Navanakorn Industrial Estate60/48, Moo 19,  
Klongluang,Pathumthani, 12120 Thailand  
Phone: +66-2-529-0542-4  
FAX: +66-2-529-0541

### ● **KYORITSU SHANGHAI TRADING COMPANY LIMITED**

Room1303, No.58 Yan'an East Road,  
Huangpu District, Shanghai 200002, China  
Phone: +86-21-6321-8899  
FAX: +86-21-5015-2015  
URL: <http://www.kew-ltd.com.cn>  
E-mail: [info@kew-ltd.com.cn](mailto:info@kew-ltd.com.cn)

### ● **Kewtech Corporation Ltd.**

Midas House, Unit 2b Stones Courtyard,  
High Street, Chesham, Buckinghamshire,  
HP5 1DE, England  
Phone: +44-1494-792212  
FAX: +44-1494-791826



## **Safety Warnings :**

Please read the "Safety Warnings" in the instruction manual supplied with the instrument thoroughly and completely for correct use. Failure to follow the safety rules can cause fire, trouble, electrical shock, etc. Therefore, make sure to operate the instrument on a correct power supply and voltage rating marked on each instrument.

■ For inquires or orders :