

# AGRO Kabelverschraubungen

## AGRO Cable Glands

Für professionelle Kabeleinführungen.  
For professional cable entries.

4.0



Progress® . Syntec® . EMV . Ex . Flanschwinkel . Zubehör  
Progress® . Syntec® . EMC . Ex . Flanged elbows . Accessories

 **KAISER**



## Professionelle Lösungen für die sichere Kabeleinführung

**Progress® Kabelverschraubungen** bieten ein umfangreiches Sortiment aus Kunststoff, Messing oder rostfreiem Stahl A2 / A4 und sind bewährte Helfer für die fachgerechte Kabeleinführung in Industrieanlagen. Die herausragende Kompressionstechnik sorgt für eine hohe Dichtigkeit und eine äusserst kabelschonende Zugentlastung.

Progress® Kabelverschraubungen aus Metall sind zertifiziert für Schienenfahrzeuge nach EN 45545-2 / -3.

**Progress® EMV-Kabelverschraubungen** aus Messing sorgen für eine niederimpedante Verbindung zwischen Schirmgeflecht und Metallgehäuse bei einer gleichzeitig sicheren Kabeleinführung.

**Progress® Ex-Kabelverschraubungen** aus Kunststoff oder Messing sorgen auch in explosionsgefährdeten Bereichen für eine sichere Kabeleinführung.

**Syntec® Kabelverschraubungen** aus Kunststoff oder Messing sind die optimale Lösung für Ihre täglichen Installations-Aufgaben. Die patentierte, einzigartige Lamellentechnik garantiert immer eine praxisgerechte Kabeleinführung, bei hervorragender Zugentlastung.

## Professional solutions for a safe cable entry

**Progress® cable glands** made of synthetics, nickel-plated brass or stainless steel A2 / A4 are proven aids for professional cable entry in industrial plants. The excellent compression technology ensures tight seals and strain relief which is exceptionally easy on cables.

Progress® metal cable glands are certified for railway applications according to EN 45545-2 / -3.

**Progress® EMC cable glands** made of nickel-plated brass ensure a low-impedance connection between the braided shield and the metal housing while maintaining secure cable entry.

**Progress® Ex cable glands** made of synthetics or nickel-plated brass ensure secure cable entry even in potentially explosive environments.

**Syntec® cable glands** made of synthetics or nickel-plated brass are the optimal solution for your daily installation tasks. The patented, unique lamellar technology always guarantees cable entry with excellent strain relief.



Alle weiterführenden Informationen zu Produkten, Systemlösungen und Kommunikationsmedien finden Sie aktuell auf unserer Internetseite [www.kaiser-elektro.de](http://www.kaiser-elektro.de) oder in der KAISER App.



Der einzigartige **Produktfinder**: Finden Sie die passende Kabelverschraubung durch Eingabe des Kabel-Durchmessers.



Please find additional information about products, system solutions and communication media on our website [www.kaiser-elektro.de](http://www.kaiser-elektro.de) or by means of the KAISER App.



The unique **product finder**: Find the right gland quickly and easily by entering the cable diameter.

### CAD-Daten in allen gängigen Formaten.

Von nahezu allen Kabelverschraubungen kann die 3D-Produktansicht eingeblendet werden. Hier bieten wir Ihnen den besonderen Service, die jeweiligen Daten in allen gängigen CAD-Formaten sich per Email zusenden zu lassen.

Die 3D-Ansicht und die Bestellmöglichkeit für die CAD-Daten können Sie über den Navigationspunkt „CAD Ansicht“ in der Produkt-Einzelansicht im Navigationsmenü unter den Produktdaten aufrufen.

### CAD-data in all current formats.

For almost all cable glands, a 3D view can be displayed. 3D CAD data may be requested and will be sent via email in all current formats.

You have the possibility to display a 3D view or to order CAD data when you choose a specific item and click on the navigation bar „CAD view“. You will find this bar at the bottom of the product specifications.



# Produktübersicht

## Product overview

Ausführung / Version	Kabelverschraubungen Progress® Messing Cable glands Progress® nickel-plated brass	Kabelverschraubungen Progress® nickel-plated brass	Spezielle Kabelverschraubungen Progress® rostfreier Stahl A2 / A4 Special Messing / Special cable glands nickel-plated brass	EMV Kabelverschraubungen und Kabeleinführungen EMC cable glands and cable entries	Ex Kabelverschraubungen Progress® Messing Ex cable glands Progress® nickel-plated brass	Kombi-Schlauchverschraubungen Progress® Messing mit integrierter Kabelverschraubung Combination conduit brass or synthetic with integrated cable gland	Kabelverschraubungen Progress® Messing Synthetic cable gland	Kabelverschraubungen Progress® nickel-plated brass Synthetic cable glands Progress®	Spezielle Kabelverschraubungen Syntec® Kunststoff Kabeleinführungen Syntec® Messing, Kunststoff Special cable glands and cable entries synthetic
Kompressionstechnik Compression technology	•	•	•	•	•	•	•	-	•
Lamellentechnik Lamellar technology	-	-	-	-	-	-	-	•	-
<b>Gewinde / Thread</b>									
Anschlussgewinde metrisch Entry thread metric	•	•	•	•	•	•	•	•	•
Anschlussgewinde Pg Entry thread Pg	•	•	•	•	•	•	•	•	•
Anschlussgewinde NPT Entry thread NPT	•	-	-	-	•	-	-	•	-
Anschlussgewinde Gasrohr Entry thread gas pipe	•	-	-	-	•	-	-	-	-
Kurzes Anschlussgewinde Short entry thread	•	-	•	•	•	•	-	•	•
Langes Anschlussgewinde Long entry thread	•	•	•	•	•	•	•	•	-
<b>Dichteinsatz / Sealing insert</b>									
für Rundkabel for round cables	•	•	•	•	•	•	•	•	•
für Flachkabel for flat cables	•	-	-	-	-	-	A	-	-
für mehrere Kabel for several cables	•	-	-	-	•	-	•	-	-
TPE/NBR-Dichteinsatz (bis 100° C) TPE/NBR sealing insert (up to 100°C)	•	•	•	•	•	•	•	•	•
FPM-Dichteinsatz (bis 200° C) FPM sealing insert (up to 200°C)	•	•	-	•	-	-	-	-	-
Spezial TPE für EN 45545 Special TPE for EN 45545	•	-	•	•	-	•	-	-	-
<b>Technische Besonderheiten / Technical features</b>									
Knickschutz Antikink	•	-	-	•	-	-	-	•	-
Biegeschutz Bending protection	•	-	•	-	•	-	-	-	-
Externe Zugentlastung External strain relief	•	-	•	•	•	-	-	-	-
Für Schlauchanschluss For conduit connecting	•	-	-	-	-	•	-	-	-
<b>Material / Material</b>									
Polyamid / Polyamide	-	-	-	-	-	-	-	•	•
Polyamid glasfaserverstärkt Polyamide fibre-glass reinforced	-	-	-	-	-	-	•	-	-
Messing vernickelt Nickel-plated brass	•	-	•	•	•	•	-	•	-
rostfreier Stahl A2 Stainless steel A2	-	•	-	-	•	-	-	-	-
rostfreier Stahl A4 Stainless steel A4	-	•	-	-	•	-	-	-	-

A = auf Anfrage / upon request



	<p><b>Kabelverschraubungen Progress® Messing</b> Cable glands Progress® nickel-plated brass</p>	 12 - 57	1
	<p><b>Kabelverschraubungen Progress® rostfreier Stahl A2 / A4</b> Cable glands Progress® stainless steel A2 / A4</p>	 58 - 65	2
	<p><b>Spezielle Kabelverschraubungen und Kabeleinführungen Messing</b> Special cable glands and cable entries nickel-plated brass</p>	 66 - 83	3
	<p><b>EMV Kabelverschraubungen Progress® Messing</b> EMC cable glands Progress® nickel-plated brass</p>	 84 - 103	4
	<p><b>Kabelverschraubungen Progress® Messing nach EN 45545</b> Cable glands Progress® nickel-plated brass according to EN 45545</p>	 104 - 107	5
	<p><b>Ex Kabelverschraubungen Messing oder Kunststoff</b> Ex cable glands nickel-plated brass or synthetic</p>	 108 - 149	6
	<p><b>Kombi-Schlauchverschraubungen Messing mit integrierter Kabelverschraubung</b> Combination conduit glands nickel-plated brass with integrated cable gland</p>	 150 - 163	7
	<p><b>Kabelverschraubungen Progress® Kunststoff</b> Synthetic cable glands Progress®</p>	 164 - 175	8
	<p><b>Kabelverschraubungen Syntec® Messing und Kunststoff</b> Cable glands Syntec®, nickel-plated brass and synthetics</p>	 176 - 189	9
	<p><b>Spezielle Kabelverschraubungen und Kabeleinführungen Kunststoff</b> Special cable glands and cable entries synthetic</p>	 190 - 195	10
	<p><b>Zubehör zu Kabelverschraubungen Kunststoff oder Metall</b> <b>AGROflex Geflechschläuche und AGROtube Glasseidenschläuche</b> Accessories for cable glands synthetic or metal AGROflex Braided sleeveings and AGROtube Braided glass fibre sleeveings</p>	 196 - 238	11
	<p><b>Zusatzinformationen / Sonderlösungen</b> Additional information / Customised solutions</p>	 239 - 274	12

# Starke Marken für internationale Märkte. Strong brands for international markets.

Hauptsitz KAISER, Schalksmühle  
KAISER headquarters, Schalksmühle, Germany



HELIA, Bornem, Belgien  
HELIA, Bornem, Belgium

AGRO, Hunzenschwil, Schweiz  
AGRO, Hunzenschwil, Switzerland

**Als führender Hersteller** von Systemen und Komponenten für die Elektro-Installation sehen wir unsere Herausforderung heute mehr denn je in der Lösung komplexer Aufgaben. Gemeinsam mit der Erfahrung und den Sortimenten unserer Unternehmen AGRO und HELIA bieten wir Ihnen kompetente Lösungen für die Elektro-Installation in Handwerk und Industrie. So finden Sie in diesem Katalog innovative Produkte und Systeme für alle Anwendungen der Kabelverschraubung – mit regionaler Stärke für internationale Märkte. Die Synergien, die wir aus dem Zusammenschluss der Unternehmen ziehen, kommen Ihnen zugute. Jeden Tag. Bei jeder Aufgabe. Bei jeder Lösung.

## Gemeinsam Zukunft gestalten.

Die KAISER Unternehmensfamilie baut auf Tradition und Fortschritt. Unser Ziel ist es, stets einen Schritt voraus zu sein mit innovativen Ideen und Lösungen für Planer, Fachhändler und Verarbeiter. Gemeinsam bieten wir Ihnen immer die perfekte Basis der guten Installation.

**As a leading manufacturer** of systems and components for electrical installations, today, more than ever, we see our challenges as lying in the solving of complex tasks. With the experience and product ranges in our AGRO and HELIA companies, we provide you with competent solutions for electrical installations in trades and industry. This is why you will find innovative products and systems for all cable gland applications in this catalogue. With regional strengths for international markets. You benefit from the synergies we obtain from the amalgamation of the companies. Every day. For every task. For every solution.

## Creating the future **together**.

The KAISER family of companies is based on tradition and progress. Our goal is always to be one step ahead with our innovative ideas and solutions for planners, specialist retailers and processors. Together we always provide you with the perfect basis for good installation.





# KAISER GROUP

 KAISER  AGRO  HELIA



Die KAISER Gruppe, ein Familienunternehmen in der dritten Generation, setzt seit jeher auf Fortschritt und Tradition. Als Innovationsführer im Bereich von Elektroinstallationsprodukten und Kabeleinführungen wollen wir für unsere Kunden mit starken Ideen und Lösungen der Branche stets einen Schritt voraus sein. Qualifizierte, erfahrene Mitarbeiterinnen und Mitarbeiter sind dabei der Garant für die hohe Qualität von KAISER. Unsere Partner im Fachhandwerk und -handel sowie in der Industrie können auf unsere Innovationskraft für die Märkte von heute und morgen vertrauen. Dies gilt auch für den kundennahen Service und die schnelle Lieferfähigkeit, die eine starke Elektromarke auszeichnen.

The KAISER Group, a family-run company in its third generation, has always placed emphasis on progress and tradition. As a leading innovator in the area of electrical installation products and cable entries, our goal is to continuously be a step ahead for the benefit of our customers through powerful ideas and solutions in this sector. In this regard, our qualified, experienced employees are the guarantee of the high quality you can expect from KAISER. Our partners in the trades and professional retailers as well as throughout industry can place their trust in our innovative power, which allows us to address the markets of today and tomorrow. The same is also true for our customer-oriented service and fast delivery times, aspects which mark a truly strong brand of electrical products.

Ulrich Kaiser  
KAISER GmbH & Co. KG

Burkard Kaiser  
Geschäftsführer / CEO  
KAISER GmbH & Co. KG



**Im Verkehrswesen** kommt es vor allem auf den sicheren Halt der Zuleitung an. Die in der Bahntechnik verwendeten Progress®-Kabelverschraubungen lockern sich trotz hoher Rüttelbelastungen nicht. Daher ermöglichen sie eine einwandfreie Strom- und Signalübertragung im gesamten Schienenfahrzeug. Zertifizierte Dichteinsätze für Schienenfahrzeuge nach EN 45545 sind nun ebenfalls verfügbar.

For **transportation**, a secure grip on the feed line is vital. The Progress® cable glands used in railway technology do not slacken, despite high vibrating loads. This results in perfect power and signal transmission throughout the train. For rail applications according to EN 45545, you can now get certified sealing inserts.

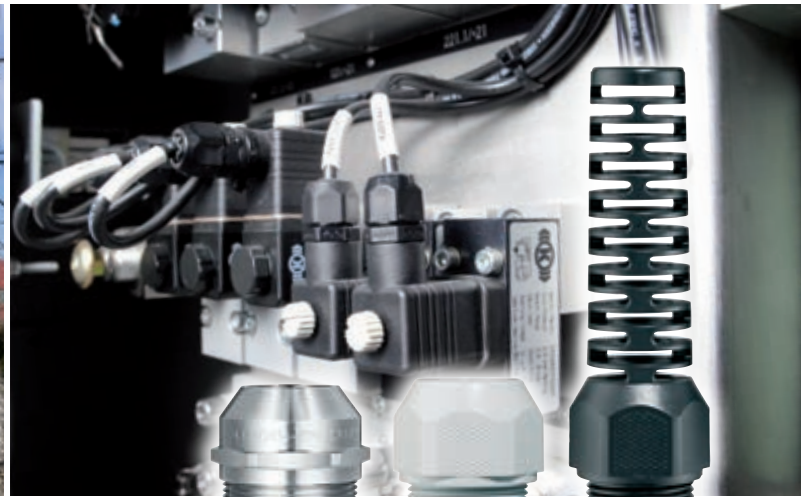

Messing oder Kunststoff Syntec® Kabelverschraubungen sind die ideale Lösung für vielfältige **tägliche Aufgaben**. Die einzigartige patentierte Lamellentechnik klemmt das Kabel auf schonende Art und Weise und garantiert eine sichere Kabeleinführung mit hervorragender Zugentlastung

Nickel-plated brass or synthetic Syntec® cable glands represent the optimal solution for a wide range of **daily tasks**. The patented, unique lamellar technology clamps the cable smoothly and guarantees practical cable entry with outstanding strain relief.



Durch Staub und Abgase entsteht ein beträchtliches Maß an chemischer Belastung in **Tunneln**. Diese erfordert den Einsatz von rostfreien und säurebeständigen Kabelverschraubungen aus rostfreiem Stahl A4 mit FPM Dichteinsatz. Kabeldurchmesser von 2.0 mm bis 52.0 mm können sicher eingeführt werden.

Dust and exhaust emissions cause high levels of chemical pollution in **tunnels**. This calls for the use of stainless and acid-resistant stainless steel A4 cable glands with FPM sealing insert. Cable diameters from 2.0 mm to 52.0 mm are used here on a daily basis.



Kabelverschraubungen für den Einsatz im **Schiffsbau** müssen spezifische Anforderungen erfüllen. Ein DNV-Zertifikat bescheinigt die Erfüllung dieser Anforderungen. Alle metrischen AGRO Kabelverschraubungen sind DNV zertifiziert. Unabhängig von ihrem Gewinde sind zusätzlich alle AGRO Ex-Kabelverschraubungen für den Einsatz im Schiffsbau zugelassen.

For **marine industry**, cable glands have to meet specific requirements. DNV certification grants the fulfillment of such requirements. All metric AGRO cable glands are DNV certified. Additionally all AGRO Ex cable glands are approved, irrespective of their entry thread.





Elektronisch gesteuerte **Umspannstationen** funktionieren so lange reibungslos, wie keine Signale durch Störströme verfälscht werden. Der konzentrische Schirmabgriff der Progress® EMV Kabelverschraubungen führt Störströme auf Masse und garantiert kleinste Transferimpedanzen.

Electronically-controlled **substations** operate in a smooth way as long as parasitic currents do not affect their function. The concentric screened tap connection of Progress® EMC cable glands discharges interference currents to earth and thus grants lowest transfer impedance.



In der **Lebensmittelindustrie** kommen Keim abtötende Substanzen zum Einsatz. Diese Substanzen garantieren auf der einen Seite die Hygiene und stellen auf der anderen Seite besondere Anforderungen an die eingesetzten Materialien der Produktionsmittel. AGRO Kabelverschraubungen aus rostfreiem Stahl A2 halten der erhöhten Beanspruchung problemlos stand. Die Kabelverschraubungen der Serie Progress® ultraFLAT sind nach EHDG zertifiziert.

In **food industries**, anti-bacterial substances guarantee a high level of safety. These chemical agents, however, also place a considerable burden on production facilities. AGRO cable glands made of stainless steel A2 reliably meet these daily challenges. The cable glands of the Progress® ultraFLAT series are EHDG certified.



**Raffinerien** und Produktionsanlagen der chemischen Industrie mit explosionsgefährdeten Bereichen stellen besondere Anforderungen an die elektrische Installation. KAISER bietet zertifizierte Kabelverschraubungen für druckfeste Kapselung Ex d IIC, für erhöhte Sicherheit Ex e II und für Eigensicherheit Ex i II an.

**Refineries** and production facilities in the chemical industry with potentially explosive areas make specific demands on electrical installations. KAISER offers special cable glands and accessories for "flameproof enclosure Ex d IIC", "increased safety Ex e II" and "intrinsic safety Ex i II" — protection types that have been standardised throughout Europe.



Bei der Realisierung von **Windkraftanlagen** bietet die Progress®-Baureihe eine kabelschonende Zugentlastung mit hoher Verdrehungsicherheit. Dabei spielt es keine Rolle, ob es sich um Rundkabel oder Flachleitungen handelt.

For the implementation of **wind turbine generators**, the Progress® range offers cable protecting strain relief with high distortion protection. This applies to both round and flat cables.



## Kabelverschraubungen Progress® in Metall.

Zertifiziert für Schienenfahrzeuge nach EN 45545.



Progress® Kabelverschraubungen aus Metall können bedenkenlos für alle Anwendungen und Anordnungen im Schienenfahrzeugbereich eingesetzt werden. Die herausragende Progress® Kompressionstechnik sorgt für eine hohe Dichtigkeit und eine äußerst kabelschonende Zugentlastung auch bei dynamischen Anwendungen. Standard- und EMV-Kabelverschraubungen mit dem entsprechenden Zubehör bilden das Basissortiment.

### Beste Resultate nach EN 45545-2

Die Dichteinsätze der Progress® Kabelverschraubungen sind aus einem speziellen TPE gefertigt und im anspruchsvollsten **Hazard Level 3** zertifiziert. Die geforderten Werte für Hazard Level 3 wurden sowohl im Außen- als auch im Innenbereich deutlich übertroffen. Progress® Kabelverschraubungen aus Metall übertreffen die Vorgaben der EN 45545-3 bei weitem und erreichen die sehr hohe Feuerwiderstandsklasse **E30**.

## Cable gland Progress® made of metal.

Certified for rolling stock, according to EN 45545.

Progress® metal cable glands can be used with confidence for any rolling stock application, in any arrangement, as has been recently certified.

The outstanding Progress® compression technology ensures tight seals and offers cables exceptional damage-preventing strain relief, even in dynamic applications. A comprehensive range of standard and EMC cable glands and accessories offers a solution for almost any application. Where the need arises, AGRO also delivers certified solutions according to customer requirements.

### Best results in testing according to EN 45545-2

The sealing inserts of Progress® cable glands are made from a special TPE and certified to the demanding **Hazard Level 3**. The stipulated values for Hazard Level 3 were exceeded, for both indoor and outdoor areas. Progress® metal cable glands easily exceed the requirements of EN 45545-3 and satisfy the very high demands of fire resistance class **E30**.



## Kabelverschraubungen Progress® ultraFLAT.

Die Idealbesetzung für Reinraum und Lebensmittelindustrie.



Die ultraflache Konstruktion der Kabelverschraubung Progress® ultraFLAT bietet wenig Oberfläche, an der sich Verschmutzungen ablagern können - die gute Reinigbarkeit für den Einsatz in Reinräumen oder der Lebensmittelindustrie wird durch das EHEDG-Zertifikat bestätigt. Ausführungen in Edelstahl und Dichteinsätze für Hochtemperaturen oder mit FDA Konformität sprechen für diese Wahl.

## Cable gland Progress® ultraFLAT.

The ideal choice for cleanrooms and food industry

The ultra flat construction of the Progress® ultraFLAT offers very little surface for contamination - the good cleanability which is crucial for cleanroom and food applications is documented by a certificate of the EHEDG. Executions in stainless steel and with high-temperature or FDA cleared sealing inserts are further arguments for this choice.



## Verschlussbolzen für Kabelverschraubungen mit Multi-Dichteinsatz.

Verschlussbolzen zum sicheren Verschließen von nicht belegten Bohrungen in Multi-Kabelverschraubungen oder zum Verschließen von einfachen Durchführungen in Standard-Kabelverschraubungen. Idealer Staub- oder Transportschutz.

## Locking pins for cable glands with multi-duct sealing insert.

Locking pins for safe closure of unassigned boreholes in standard cable glands with ducts for several cables or to close single feeds of standard cable glands. Ideal dust or transport protection.

S. 89

## Kabelverschraubung Progress® EMV easyCONNECT Multi.

EMV-Kabelverschraubung für mehrere Kabel.

Die Progress® easyCONNECT Multi ist die erste Kabelverschraubung, die das Einführen von mehreren geschirmten Kabeln in ein Gehäuse erlaubt - und dies mit kraftvollem und sicherem Schirmabgriff.

- Die Montage ist einfach, sicher und schnell
- Die Kontaktfeder schont die Schirmgeflechte
- Der Schirmkontakt erfolgt durch schonende und doch kraftvolle Klemmung und gewährleistet hervorragende Ableitwerte
- Die Kabel bleiben während des Montageprozesses dreh-, schieb- und demontierbar

## Cable gland Progress® EMC easyCONNECT Multi.

EMC cable gland for several cables.

The Progress® easyCONNECT Multi is the first cable gland that allows for the entry of several shielded cables into a housing - at any moment granting a strong and safe tap connection.

- Fast, safe and easy assembly
- The contact spring is easy on the cable shields
- The tap connection is assured by a gentle but strong way of clamping and results in an excellent conductivity values
- Cables may be rotated, moved and removed during the assembly

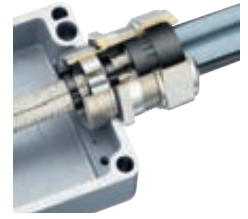

S. 198

## Druckausgleichselemente.

Mit Membrane oder Sinterfilter.

Um Druckdifferenzen, hohe Luftfeuchtigkeit und Kondenswasserbildung im Gehäuse zu verhindern, müssen ein stetiger Druckausgleich und Luftwechsel stattfinden. Der Einbau von AGRO Druckausgleichselementen in Elektro- und Elektronikgehäusen bewirkt einen effizienten Druckausgleich und sorgt für eine konstante Belüftung und bei Bedarf auch für Entwässerung.

Druckausgleichselemente sind mit Membrane und Sinterfilter oder mit Sieb als Entwässerungselement in den Ausführungen **Messing vernickelt** oder **Kunststoff** erhältlich.

## Pressure balance elements.

With membrane or sinter filter.

To prevent pressure differences, high humidity and condensation of water in the housing, constant balancing of pressure and exchange of air is needed. The use of AGRO pressure balance elements in electrical and electronics housings allows efficient pressure balance and ventilation, and if necessary, drainage.

Pressure balance elements are available with membrane and sinter filter or with mesh to function as drainage element. We offer versions in **nickel-plated brass** or **synthetic material**.



S. 249

## Kundenspezifische Lösungen.

Wir machens möglich.

Als kompetenter Partner bieten wir nicht nur ein breites Standard-Sortiment sondern entwickeln auch kundenspezifische Lösungen, passend für individuelle Anwendungsfälle.

Schon in der Entwicklungsphase beraten wir Sie bei der Umsetzung Ihrer Projekte. Dadurch ist es möglich, die hohen Anforderungen Ihrer Produkte an Funktionalität und Design unter wirtschaftlichen Gesichtspunkten gemeinsam zu gestalten.

- Viele Lösungen aus unserem Progress® Baukasten sind schnell und einfach realisierbar
- Individuelle Systemlösungen für spezielle Anforderungen
- Umfangreiche Beratung und Bemusterung bereits in der Entwicklungsphase

## Customised solutions.

We make it possible.

As your competent partner, we not only offer a wide range of standard products, but also develop customised solutions to accommodate your specific needs.

Already in the development phase, we will be pleased to provide advice on the implementation of your projects. This will enable us to jointly define the high requirements of your products in terms of functionality and design from an economic perspective.

- Many solutions from our Progress® construction set can be implemented quickly and easily
- Individual system solutions for special requirements
- Comprehensive advice and provision of samples as early as the development phase





# AGRO Kabelverschraubungen Progress® Messing

## AGRO Cable glands Progress® nickel-plated brass

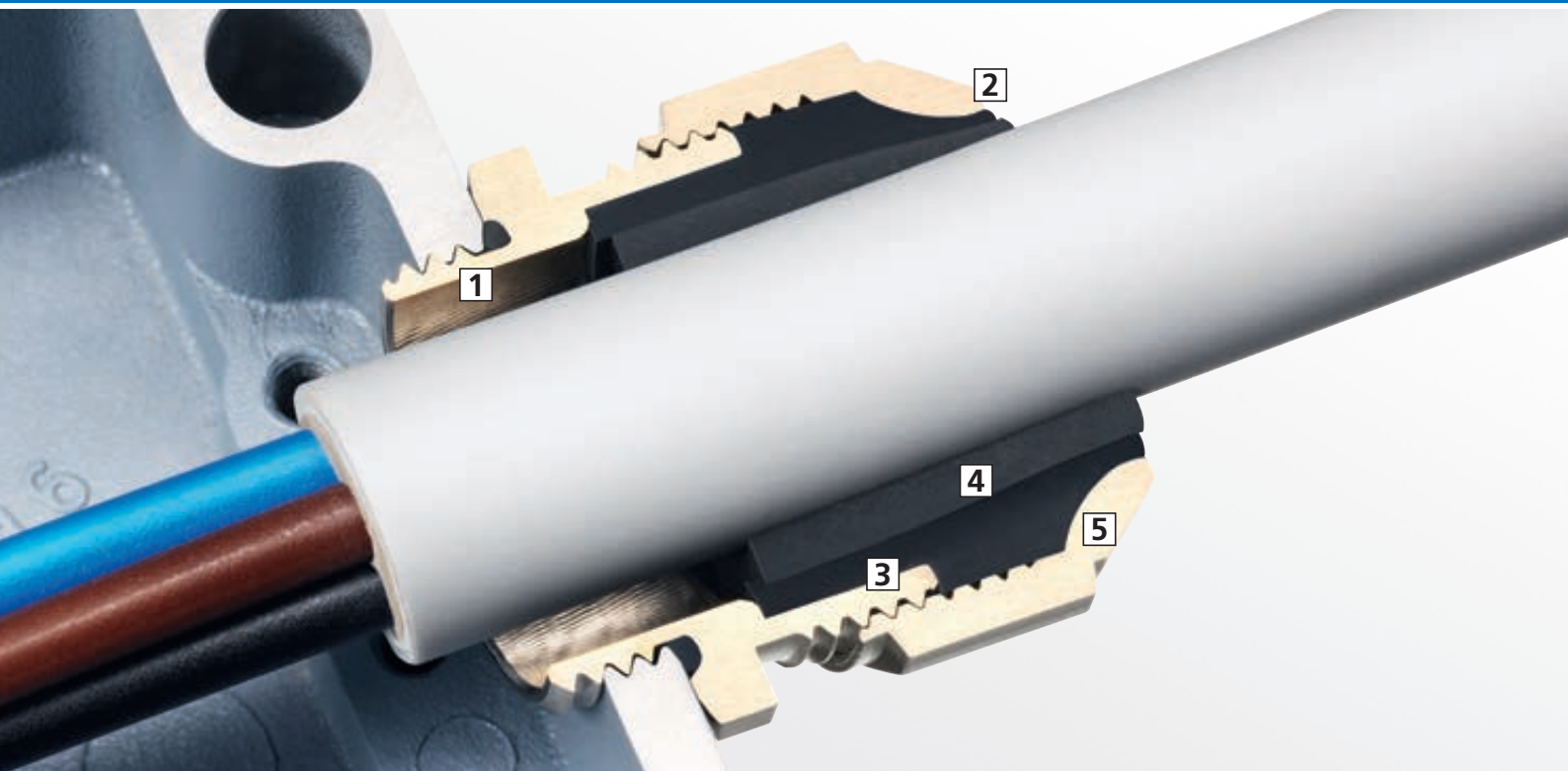

**AGRO Kabelverschraubungen Progress® Messing vernickelt** sind bewährte Helfer für die fachgerechte Kabeleinführung in Industrieanlagen. Durch die richtige Wahl mit dem passenden Dichteinsatz sind sie überall einsetzbar. Die herausragende Kompressionstechnik sorgt für eine hohe Dichtigkeit und eine äußerst kabelschonende Zugentlastung auch bei dynamischen Belastungen.

AGRO Progress® Kabelverschraubungen aus Metall mit Dichteinsätzen aus einem speziellen TPE sind zertifiziert nach EN 45545 und können bedenkenlos für alle Anwendungen und Anordnungen im Schienenfahrzeugbau eingesetzt werden.

### 1 Kurze, lange oder Spezial-Anschlussgewinde

Kabelverschraubungen Progress® mit kurzem oder langem Anschlussgewinde in metrischer, Pg-, Gasrohr oder NPT-Ausführung können bei vorhandenem Öffnungsgewinde oder mit Gegenmutter verwendet werden.

### 2 Sichtbare Sicherheit

Der kleine Wulst des Dichteinsatzes bestätigt das richtige Anzugsmoment.

### 3 Hoher Verdrehenschutz

Die im Unterteil integrierte Längsrandrierung sorgt über den Dichteinsatz für eine hohe Verdrehsicherheit.

### 4 Große Flexibilität

Zweiteilige Dichteinsätze können in Sekundenschnelle vor Ort auf den vorhandenen Kabeldurchmesser angepasst werden.

### 5 Garantierte Dichtigkeit

Auf den Dichteinsatz abgestimmte Innenkonturen sorgen für eine zielgerichtete Verformung des Dichteinsatzes und garantieren somit dessen perfekte Abdichtung. Die Schutzart IP 68 bis 10 bar sowie IP 69K ermöglichen eine breite Anwendung.

**Cable glands Progress® nickel-plated brass** are tried and tested aids for correct cable entry in industrial equipment. If the correct choice with the right sealing insert, these glands can be used anywhere. The outstanding compression technology for use everywhere guarantees an effective seal and excellent cable-protecting strain relief, also by vibrations.

AGRO Progress® metal cable glands equipped with sealing inserts made of a special TPE are certified according to EN 45545 and can be used with confidence for any rolling stock application.

### 1 Short, long or special entry thread

Cable glands Progress® with short or long entry thread designed as metric, Pg, imperial or NPT can be used with existing opening threads or with a counter nut.

### 2 Visible safety

The small bead in the sealing insert confirms the correct tightening torque.

### 3 High distortion protection

The integrated retaining grooves in the lower part and in the sealing insert grant against twisting.

### 4 Great flexibility

It only takes a few seconds to adapt the two-part sealing inserts on site to the existing cable diameters.

### 5 Guaranteed seal

Inner contours matched to the sealing insert ensure a targeted deformation of the insert and thus guarantee its tightness in compliance with protection class IP 68 up to 10 bar and IP 69K for a wide range of applications.



Progress®-Bauteile können frei kombiniert werden  
Progress® components are freely combineable

**Oberteil / Upper part**



Standard-Druckmutter  
Standard compression nut



Knickschutz  
Antikink spring



Trompete  
Trumpet



Klemmbacken und Trompete  
Trumpet with clamps



Klemmbacken  
Clamps



Schlauchverschraubungen  
Conduit glands

**Dichteinsatz / Sealing inserts**



Kurzer ein- oder zweiteiliger Dichteinsatz in NBR, TPE, Spezial TPE nach EN 45545 oder FPM (temperaturbeständig) / Short one or two-piece sealing insert made of NBR, TPE, special TPE acc. EN 45545 or FPM (heat resistant)

Langer durchgehend isolierender Dichteinsatz in NBR, TPE, Spezial TPE nach EN 45545 ein- oder zweiteilig / Long one or two-piece overall length insulating sealing insert made of NBR or TPE special TPE acc. EN 45545

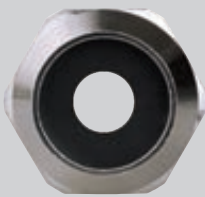

mit Standard-Bohrungen  
with standard holes

mit individuellen Öffnungen  
with customised holes



**Unterteil / Lower Part**



mit kurzem Anschlussgewinde  
with short entry thread

- metrisch / metric
- Pg / Pg
- NPT / NPT
- Gasrohr / gaspipe



mit langem Anschlussgewinde  
with long entry thread

- metrisch / metric
- Pg / Pg
- NPT / NPT
- Gasrohr / gaspipe

**Progress® Messing  
 Progress® nickel-plated brass**

**Standard**

**für hohe Temperaturen  
 for high temperatures**

**für mehrere Kabel  
 for installation of multiple cables**

**mit Dichteinsatz  
 with sealing insert without drilled hole**

**für spezielle Kabel  
 for special cables**

**mit Knickschutzfeder  
 with special entry thread**

**mit Knickschutzfeder  
 with antikink spring**

**mit Klemmbacken  
 with clamps**

**mit Trompete  
 with trumpet**

**mit Trompete und Klemmbacken  
 with trumpet and clamps**

<b>Ausführung / Version</b>											
Kompressionstechnik Compression technology		•	•	•	•	•	•	•	•	•	•
<b>Gewinde / Thread</b>											
Anschlussgewinde metrisch Entry thread metric		•	•	•	•	•	•	•	•	•	•
Anschlussgewinde Pg Entry thread Pg		•	•	•	•	•	•	•	•	•	•
Anschlussgewinde NPT Entry thread NPT		•	-	-	-	-	-	-	-	-	-
Anschlussgewinde Gasrohr Entry thread gas pipe		•	-	-	-	-	-	-	-	-	-
Kurzes Anschlussgewinde (Standard) Short entry thread (standard)		•	•	•	•	•	•	•	•	•	•
Langes Anschlussgewinde Long entry thread		•	•	•	•	•	-	•	•	•	•
Sondergewinde (extra lang, Innengewinde) Special thread (extra long, internal thread)		•	-	-	-	-	•	-	-	-	-
<b>Dichteinsatz / Sealing insert</b>											
für Rundkabel for round cables		•	•	•	-	-	•	•	•	•	•
für Flachkabel for flat cables		•	-	-	-	•	-	-	-	-	-
für mehrere Kabel (Multi-Dichteinsatz) for multi sealing insert		•	-	•	-	-	-	-	-	-	-
Vollgummi-Dichteinsatz Solid rubber sealing insert		•	•	-	•	-	-	-	-	-	-
einteiliger Dichteinsatz One-piece sealing insert		•	•	•	•	•	-	•	•	-	-
zweiteiliger Dichteinsatz Two-piece sealing insert		•	•	-	-	-	•	•	•	•	•
Spezial TPE nach EN 45545 Special TPE acc. to EN 45545		•	-	•	•	•	•	•	•	•	•
<b>Technische Besonderheiten / Technical features</b>											
Vibrationsschutz Vibration resistance		•	•	•	•	•	•	•	•	•	•
<b>Material / Material</b>											
Messing vernickelt Nickel-plated brass		•	•	•	•	•	•	•	•	•	•



<p>Kabelverschraubungen Progress® Messing          Cable glands Progress® nickel-plated brass</p>		<p>16 - 29</p>	<p>1</p>
<p>Kabelverschraubungen Progress® Messing für hohe Temperaturen          Cable glands Progress® nickel-plated brass for high temperature applications</p>		<p>30 - 33</p>	<p>2</p>
<p>Kabelverschraubungen Progress® Messing für mehrere Kabel          Cable glands Progress® nickel-plated brass for installation of multiple cables</p>		<p>34 - 37</p>	<p>3</p>
<p>Kabelverschraubungen Progress® Messing mit Dichteinsatz ohne Bohrung          Cable glands Progress® nickel-plated brass with sealing insert without drilled hole</p>		<p>38 - 39</p>	<p>4</p>
<p>Kabelverschraubungen Progress® Messing für spezielle Kabel          Cable glands Progress® nickel-plated brass for special cables</p>		<p>40 - 42</p>	<p>5</p>
<p>Kabelverschraubungen Progress® Messing mit speziellem Anschlussgewinde          Cable glands Progress® nickel-plated brass with special entry thread</p>		<p>43 - 44</p>	<p>6</p>
<p>Kabelverschraubungen Progress® Messing mit Knickschutzfeder          Cable glands Progress® nickel-plated brass with antikink spring</p>		<p>45 - 47</p>	<p>7</p>
<p>Kabelverschraubungen Progress® Messing mit Klemmbacken          Cable glands Progress® nickel-plated brass with clamps</p>		<p>48 - 53</p>	<p>8</p>
<p>Kabelverschraubungen Progress® Messing mit Trompete          Cable glands Progress® nickel-plated brass with trumpet</p>		<p>54 - 55</p>	<p>10</p>
<p>Kabelverschraubungen Progress® Messing mit Trompete und Klemmbacken          Cable glands Progress® nickel-plated brass with trumpet and clamps</p>		<p>56 - 57</p>	<p>11</p>

# Kabelverschraubungen Progress® Messing

## Cable glands Progress® nickel-plated brass

### Kurzes Anschlussgewinde metrisch | Short entry thread metric

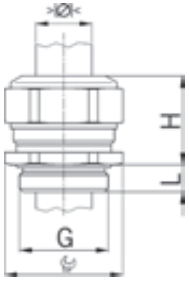

Material: Messing vernickelt  
 Dichtung: TPE  
 O-Ring : NBR  
 Zugentlastung: Ausführung A  
 Einsatztemperatur: -40°C / +100°C  
 Schutzart: IP 68 (bis 10 bar)  
 Weitere Schutzart: IP 69K

Material: Nickel-plated brass  
 Seal: TPE  
 O-ring : NBR  
 Strain relief: Version A  
 Temperature range: -40°C / +100°C  
 Protection class: IP 68 (up to 10 bar)  
 Further protection: IP 69K



#### Progress MS

Einteiliger Dichteinsatz  
 durchgehend isolierend

One-piece sealing insert  
 overall length insulated



G	>Ø< min mm	>Ø< max mm	PC	H mm	L mm	i info	Art.-Nr.   Art. No.	
M6x1.0	2.0	2.5	8	12	5	1	1060.06.025	50
M6x1.0	2.5	3.0	8	12	5	1	1060.06.030	50
M8x1.25	2.5	3.0	11	14	5	1	1060.08.030	50
M8x1.25	3.0	4.0	11	14	5	1	1060.08.040	50
M10x1.5	3.0	4.0	13	15	5	1	1060.10.040	50
M10x1.5	4.0	6.0	13	15	5	1	1060.10.060	50
M12x1.5	3.5	5.0	15	17	5	-	1060.12.050	50
M12x1.5	5.0	6.5	15	17	5	-	1060.12.065	50
M12x1.5	6.5	7.5	15	17	5	-	1060.12.075	50
M16x1.5	4.5	6.0	18	20	5	-	1060.17.060	50
M16x1.5	6.0	8.0	18	20	5	-	1060.17.080	50
M16x1.5	8.0	10.5	18	22	5	-	1060.17.105	50
M20x1.5	6.0	8.0	24	21	6	-	1060.20.080	50
M20x1.5	8.0	11.0	24	21	6	-	1060.20.110	50
M20x1.5	11.0	14.5	24	23	6	-	1060.20.145	50
M25x1.5	9.5	12.5	30	25	7	-	1060.25.125	25
M25x1.5	12.5	16.0	30	25	7	-	1060.25.160	25
M25x1.5	16.0	19.0	30	28	7	-	1060.25.190	25
M32x1.5	17.0	21.0	36	28	8	-	1060.32.210	25
M32x1.5	21.0	25.5	36	28	8	-	1060.32.255	25
M40x1.5	24.0	28.5	46	31	8	-	1060.40.285	10
M40x1.5	28.5	33.0	46	31	8	-	1060.40.330	10
M50x1.5	33.0	37.0	55	34	9	-	1060.50.370	10
M50x1.5	37.0	42.0	55	34	9	-	1060.50.420	10
M63x1.5	40.0	46.0	70	37	10	-	1060.63.460	5
M63x1.5	46.0	52.0	70	37	10	-	1060.63.520	5
M75x1.5	50.0	56.0	80	38	11	-	1060.75.560	1
M75x1.5	56.0	63.0	80	38	11	-	1060.75.630	1

1 = Metrisches Regelgewinde

1 = Metric coarse-pitch thread

Erhältlich mit Dichteinsatz gemäß EN 45545. Bei Anfragen oder Bestellung bitte ein F vor die Artikelnummer setzen.

Available with sealing inserts conformity with EN 45545. When placing an inquiry, prefix the article number by the capital F.

#### Progress MS

Zweiteiliger Dichteinsatz  
 durchgehend isolierend

Two-piece sealing insert  
 overall length insulated



G	>Ø< min mm	>Ø< max mm	PC	H mm	L mm	Art.-Nr.   Art. No.	
M16x1.5	6.0	10.5	18	22	5	1060.17	50
M20x1.5	8.0	14.5	24	23	6	1060.20	50
M25x1.5	12.5	19.0	30	28	7	1060.25	25
M32x1.5	17.0	25.5	36	28	8	1060.32	25
M40x1.5	24.0	33.0	46	31	8	1060.40	10
M50x1.5	33.0	42.0	55	34	9	1060.50	10
M63x1.5	40.0	52.0	70	37	10	1060.63	5
M75x1.5	50.0	63.0	80	38	11	1060.75	1

Erhältlich mit Dichteinsatz gemäß EN 45545. Bei Anfragen oder Bestellung bitte ein F vor die Artikelnummer setzen.

Available with sealing inserts conformity with EN 45545. When placing an inquiry, prefix the article number by the capital F.



# Kabelverschraubungen Progress® Messing

## Cable glands Progress® nickel-plated brass

### Kurzes Anschlussgewinde metrisch | Short entry thread metric

Material: Messing vernickelt  
 Dichtung: TPE / NBR  
 O-Ring : NBR  
 Zugentlastung: Ausführung A  
 Einsatztemperatur: -40°C / +100°C  
 Schutzart: IP 68 (bis 10 bar)  
 Weitere Schutzart: IP 69K

Material: Nickel-plated brass  
 Seal: TPE / NBR  
 O-ring : NBR  
 Strain relief: Version A  
 Temperature range: -40°C / +100°C  
 Protection class: IP 68 (up to 10 bar)  
 Further protection: IP 69K

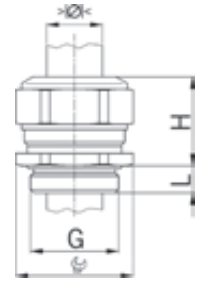

#### Progress MS



Einteiliger Dichteinsatz  
 nicht durchgehend isolierend

One-piece sealing insert  
 not overall length insulated

G	>Ø< min mm	>Ø< max mm		H mm	L mm	i info	Art.-Nr.   Art. No.	
M6x1.0	2.0	2.5	8	12	5	1	1000.06.025	50
M6x1.0	2.5	3.0	8	12	5	1	1000.06.030	50
M6x1.0	3.0	3.5	8	12	5	1	1000.06.035	50
M8x1.25	2.5	3.5	11	14	5	1	1000.08.035	50
M8x1.25	3.5	5.0	11	14	5	1	1000.08.050	50
M10x1.5	3.0	4.0	13	15	5	1	1000.10.040	50
M10x1.5	4.0	6.0	13	15	5	1	1000.10.060	50
M12x1.5	3.5	5.0	15	17	5	-	1000.12.050	50
M12x1.5	5.0	6.5	15	17	5	-	1000.12.065	50
M12x1.5	6.5	8.0	15	17	5	-	1000.12.080	50
M16x1.5	3.5	4.5	18	20	5	-	1000.17.045	50
M16x1.5	4.5	6.0	18	20	5	-	1000.17.060	50
M16x1.5	6.0	8.0	18	20	5	-	1000.17.080	50
M16x1.5	8.0	10.5	18	22	5	-	1000.17.105	50
M20x1.5	6.0	8.0	24	21	6	-	1000.20.080	50
M20x1.5	8.0	11.0	24	21	6	-	1000.20.110	50
M20x1.5	11.0	15.0	24	23	6	-	1000.20.150	50
M25x1.5	9.5	12.5	30	25	7	-	1000.25.125	25
M25x1.5	12.5	16.0	30	27	7	-	1000.25.160	25
M25x1.5	16.0	20.5	30	28	7	-	1000.25.205	25
M32x1.5	14.0	17.0	36	28	8	-	1000.32.170	25
M32x1.5	17.0	21.0	36	28	8	-	1000.32.210	25
M32x1.5	21.0	25.5	36	28	8	-	1000.32.255	25
M40x1.5	20.0	24.0	46	31	8	-	1000.40.240	10
M40x1.5	24.0	28.5	46	31	8	-	1000.40.285	10
M40x1.5	28.5	33.0	46	31	8	-	1000.40.330	10
M50x1.5	29.0	33.0	55	34	9	-	1000.50.330	10
M50x1.5	33.0	37.0	55	34	9	-	1000.50.370	10
M50x1.5	37.0	42.0	55	34	9	-	1000.50.420	10
M63x1.5	35.0	40.0	70	37	10	-	1000.63.400	5
M63x1.5	40.0	46.0	70	37	10	-	1000.63.460	5
M63x1.5	46.0	52.0	70	37	10	-	1000.63.520	5
M75x1.5	45.0	50.0	80	38	11	-	1000.75.500	1
M75x1.5	50.0	56.0	80	38	11	-	1000.75.560	1
M75x1.5	56.0	63.0	80	38	11	-	1000.75.630	1
M85x2.0	63.0	70.0	95	41	18	-	1000.85.700	1
M95x2.0	68.0	75.0	110	51	20	-	1000.95.750	1
M95x2.0	73.0	80.0	110	51	20	-	1000.95.800	1
M100x3.0	78.0	85.0	115	51	22	-	1000.100.850	1
M105x3.0	83.0	90.0	120	52	22	-	1000.105.900	1
M115x3.0	88.0	95.0	125	52	22	-	1000.115.950	1



1 = Metrisches Regelgewinde

1 = Metric coarse-pitch thread

Erhältlich mit Dichteinsatz gemäß EN 45545. Bei Anfragen oder Bestellung bitte ein F vor die Artikelnummer setzen.

Available with sealing inserts conformity with EN 45545. When placing an inquiry, prefix the article number by the capital F.

# Kabelverschraubungen Progress® Messing

## Cable glands Progress® nickel-plated brass

### Kurzes Anschlussgewinde metrisch | Short entry thread metric

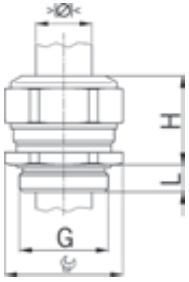

Material: Messing vernickelt  
 Dichtung: TPE  
 O-Ring : NBR  
 Zugentlastung: Ausführung A  
 Einsatztemperatur: -40°C / +100°C  
 Schutzart: IP 68 (bis 10 bar)  
 Weitere Schutzart: IP 69K

Material: Nickel-plated brass  
 Seal: TPE  
 O-ring : NBR  
 Strain relief: Version A  
 Temperature range: -40°C / +100°C  
 Protection class: IP 68 (up to 10 bar)  
 Further protection: IP 69K

#### Progress MS



Zweiteiliger Dichteinsatz  
 nicht durchgehend isolierend

Two-piece sealing insert  
 not overall length insulated

G	>Ø< min mm	>Ø< max mm	HTC	H mm	L mm	Art.-Nr.   Art. No.	
M16x1.5	6.0	10.5	18	22	5	1000.17	50
M20x1.5	8.0	15.0	24	23	6	1000.20	50
M25x1.5	12.5	20.5	30	28	7	1000.25	25
M32x1.5	17.0	25.5	36	28	8	1000.32	25
M40x1.5	24.0	33.0	46	31	8	1000.40	10
M50x1.5	33.0	42.0	55	34	9	1000.50	10
M63x1.5	40.0	52.0	70	37	10	1000.63	5
M75x1.5	50.0	63.0	80	38	11	1000.75	1

Erhältlich mit Dichteinsatz gemäß EN 45545. Bei Anfragen oder Bestellung bitte ein F vor die Artikelnummer setzen.

Available with sealing inserts conformity with EN 45545. When placing an inquiry, prefix the article number by the capital F.

# Kabelverschraubungen Progress® Messing

## Cable glands Progress® nickel-plated brass

### Langes Anschlussgewinde metrisch | Long entry thread metric

Material: Messing vernickelt  
 Dichtung: TPE  
 O-Ring : NBR  
 Zugentlastung: Ausführung A  
 Einsatztemperatur: -40°C / +100°C  
 Schutzart: IP 68 (bis 10 bar)  
 Weitere Schutzart: IP 69K

Material: Nickel-plated brass  
 Seal: TPE  
 O-ring : NBR  
 Strain relief: Version A  
 Temperature range: -40°C / +100°C  
 Protection class: IP 68 (up to 10 bar)  
 Further protection: IP 69K

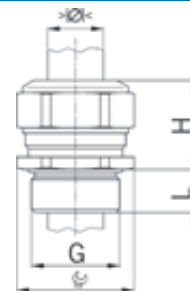

#### Progress MS



Einteiliger Dichteinsatz  
 durchgehend isolierend

One-piece sealing insert  
 overall length insulated

G	> Ø < min mm	> Ø < max mm	 mm	H mm	L mm	i info	Art.-Nr.   Art. No.	
M6x1.0	2.0	2.5	8	12	8	1	1160.06.025	50
M6x1.0	2.5	3.0	8	12	8	1	1160.06.030	50
M8x1.25	2.5	3.0	11	14	10	1	1160.08.030	50
M8x1.25	3.0	4.0	11	14	10	1	1160.08.040	50
M10x1.5	3.0	4.0	13	15	10	1	1160.10.040	50
M10x1.5	4.0	6.0	13	15	10	1	1160.10.060	50
M12x1.5	3.5	5.0	15	17	10	-	1160.12.050	50
M12x1.5	5.0	6.5	15	17	10	-	1160.12.065	50
M12x1.5	6.5	7.5	15	17	10	-	1160.12.075	50
M16x1.5	8.0	10.5	18	22	10	-	1160.17.105	50
M20x1.5	11.0	14.5	24	23	10	-	1160.20.145	50
M25x1.5	16.0	19.0	30	28	11	-	1160.25.190	25
M32x1.5	21.0	25.5	36	28	13	-	1160.32.255	25
M40x1.5	28.5	33.0	46	34	13	-	1160.40.330	10
M50x1.5	37.0	42.0	55	34	14	-	1160.50.420	10
M63x1.5	46.0	52.0	70	37	14	-	1160.63.520	5
M75x1.5	56.0	63.0	80	38	15	-	1160.75.630	1

1 = Metrisches Regelgewinde

1 = Metric coarse-pitch thread

Erhältlich mit Dichteinsatz gemäß EN 45545. Bei Anfragen oder Bestellung bitte ein F vor die Artikelnummer setzen.

Available with sealing inserts conformity with EN 45545. When placing an inquiry, prefix the article number by the capital F.



#### Progress MS



Zweiteiliger Dichteinsatz  
 durchgehend isolierend

Two-piece sealing insert  
 overall length insulated

G	> Ø < min mm	> Ø < max mm	 mm	H mm	L mm	Art.-Nr.   Art. No.	
M16x1.5	6.0	10.5	18	22	10	1160.17	50
M20x1.5	8.0	14.5	24	23	10	1160.20	50
M25x1.5	12.5	19.0	30	28	11	1160.25	25
M32x1.5	17.0	25.5	36	28	13	1160.32	25
M40x1.5	24.0	33.0	46	31	13	1160.40	10
M50x1.5	33.0	42.0	55	34	14	1160.50	10
M63x1.5	40.0	52.0	70	37	14	1160.63	5
M75x1.5	50.0	63.0	80	38	15	1160.75	1

Erhältlich mit Dichteinsatz gemäß EN 45545. Bei Anfragen oder Bestellung bitte ein F vor die Artikelnummer setzen.

Available with sealing inserts conformity with EN 45545. When placing an inquiry, prefix the article number by the capital F.



# Kabelverschraubungen Progress® Messing

## Cable glands Progress® nickel-plated brass

Langes Anschlussgewinde metrisch | Long entry thread metric

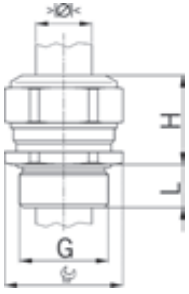

Material: Messing vernickelt  
 Dichtung: TPE  
 O-Ring : NBR  
 Zugentlastung: Ausführung A  
 Einsatztemperatur: -40°C / +100°C  
 Schutzart: IP 68 (bis 10 bar)  
 Weitere Schutzart: IP 69K

Material: Nickel-plated brass  
 Seal: TPE  
 O-ring : NBR  
 Strain relief: Version A  
 Temperature range: -40°C / +100°C  
 Protection class: IP 68 (up to 10 bar)  
 Further protection: IP 69K



### Progress MS



Einteiliger Dichteinsatz  
 nicht durchgehend isolierend

One-piece sealing insert  
 not overall length insulated

G	> Ø < min mm	> Ø < max mm	 mm	H mm	L mm	i info	Art.-Nr.   Art. No.	
M6x1.0	2.0	2.5	8	12	8	1	1100.06.025	50
M6x1.0	2.5	3.0	8	12	8	1	1100.06.030	50
M6x1.0	3.0	3.5	8	12	8	1	1100.06.035	50
M8x1.25	2.5	3.5	11	14	10	1	1100.08.035	50
M8x1.25	3.5	5.0	11	14	10	1	1100.08.050	50
M10x1.5	3.0	4.0	13	15	10	1	1100.10.040	50
M10x1.5	4.0	6.0	13	15	10	1	1100.10.060	50
M12x1.5	3.5	5.0	15	17	10	-	1100.12.050	50
M12x1.5	5.0	6.5	15	17	10	-	1100.12.065	50
M12x1.5	6.5	8.0	15	17	10	-	1100.12.080	50
M16x1.5	3.5	4.5	18	20	10	-	1100.17.045	50
M16x1.5	4.5	6.0	18	20	10	-	1100.17.060	50
M16x1.5	6.0	8.0	18	20	10	-	1100.17.080	50
M16x1.5	8.0	10.5	18	22	10	-	1100.17.105	50
M20x1.5	6.0	8.0	24	21	10	-	1100.20.080	50
M20x1.5	8.0	11.0	24	21	10	-	1100.20.110	50
M20x1.5	11.0	15.0	24	23	10	-	1100.20.150	50
M25x1.5	9.5	12.5	30	25	11	-	1100.25.125	25
M25x1.5	12.5	16.0	30	27	11	-	1100.25.160	25
M25x1.5	16.0	20.5	30	28	11	-	1100.25.205	25
M32x1.5	14.0	17.0	36	28	13	-	1100.32.170	25
M32x1.5	17.0	21.0	36	28	13	-	1100.32.210	25
M32x1.5	21.0	25.5	36	28	13	-	1100.32.255	25
M40x1.5	20.0	24.0	46	31	13	-	1100.40.240	10
M40x1.5	24.0	28.5	46	31	13	-	1100.40.285	10
M40x1.5	28.5	33.0	46	31	13	-	1100.40.330	10
M50x1.5	29.0	33.0	55	34	14	-	1100.50.330	10
M50x1.5	33.0	37.0	55	34	14	-	1100.50.370	10
M50x1.5	37.0	42.0	55	34	14	-	1100.50.420	10
M63x1.5	35.0	40.0	70	37	14	-	1100.63.400	5
M63x1.5	40.0	46.0	70	37	14	-	1100.63.460	5
M63x1.5	46.0	52.0	70	37	14	-	1100.63.520	5
M75x1.5	45.0	50.0	80	38	15	-	1100.75.500	1
M75x1.5	50.0	56.0	80	38	15	-	1100.75.560	1
M75x1.5	56.0	63.0	80	38	15	-	1100.75.630	1

1 = Metrisches Regelgewinde

1 = Metric coarse-pitch thread

Erhältlich mit Dichteinsatz gemäß EN 45545. Bei Anfragen oder Bestellung bitte ein F vor die Artikelnummer setzen.

Available with sealing inserts conformity with EN 45545. When placing an inquiry, prefix the article number by the capital F.



# Kabelverschraubungen Progress® Messing

## Cable glands Progress® nickel-plated brass

Langes Anschlussgewinde metrisch | Long entry thread metric

Material: Messing vernickelt  
 Dichtung: TPE  
 O-Ring : NBR  
 Zugentlastung: Ausführung A  
 Einsatztemperatur: -40°C / +100°C  
 Schutzart: IP 68 (bis 10 bar)  
 Weitere Schutzart: IP 69K

Material: Nickel-plated brass  
 Seal: TPE  
 O-ring : NBR  
 Strain relief: Version A  
 Temperature range: -40°C / +100°C  
 Protection class: IP 68 (up to 10 bar)  
 Further protection: IP 69K

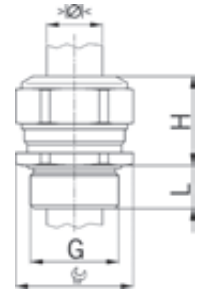



### Progress MS



Zweiteiliger Dichteinsatz  
 nicht durchgehend isolierend

Two-piece sealing insert  
 not overall length insulated

G	> Ø < min mm	> Ø < max mm	 mm	H mm	L mm	Art.-Nr.   Art. No.	
M16x1.5	6.0	10.5	18	22	10	1100.17	50
M20x1.5	8.0	15.0	24	23	10	1100.20	50
M25x1.5	12.5	20.5	30	28	11	1100.25	25
M32x1.5	17.0	25.5	36	28	13	1100.32	25
M40x1.5	24.0	33.0	46	31	13	1100.40	10
M50x1.5	33.0	42.0	55	34	14	1100.50	10
M63x1.5	40.0	52.0	70	37	14	1100.63	5
M75x1.5	50.0	63.0	80	38	15	1100.75	1

Erhältlich mit Dichteinsatz gemäß EN 45545. Bei Anfragen oder Bestellung bitte ein F vor die Artikelnummer setzen.

Available with sealing inserts conformity with EN 45545. When placing an inquiry, prefix the article number by the capital F.



# Kabelverschraubungen Progress® Messing

## Cable glands Progress® nickel-plated brass

### Kurzes Anschlussgewinde Pg | Short entry thread Pg

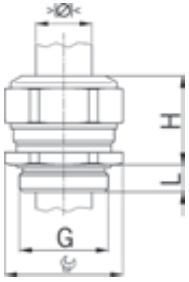

Material: Messing vernickelt  
 Dichtung: TPE  
 O-Ring : NBR  
 Einsatztemperatur: -40°C / +100°C  
 Schutzart: IP 68 (bis 10 bar)  
 Weitere Schutzart: IP 69K

Material: Nickel-plated brass  
 Seal: TPE  
 O-ring : NBR  
 Temperature range: -40°C / +100°C  
 Protection class: IP 68 (up to 10 bar)  
 Further protection: IP 69K



#### Progress MS



Einteiliger Dichteinsatz  
 durchgehend isolierend

One-piece sealing insert  
 overall length insulated

G	>Ø< min mm	>Ø< max mm		H mm	L mm	Art.-Nr.   Art. No.	
Pg 7	3.5	5.0	15	17	6.0	1060.07.050	50
Pg 7	5.0	6.5	15	17	6.0	1060.07.065	50
Pg 7	6.5	7.5	15	17	6.0	1060.07.075	50
Pg 9	4.5	6.0	18	20	6.0	1060.09.060	50
Pg 9	6.0	8.0	18	20	6.0	1060.09.080	50
Pg 9	8.0	10.5	18	22	6.0	1060.09.105	50
Pg 11	4.0	5.5	21	21	6.0	1060.11.055	50
Pg 11	5.5	8.5	21	21	6.0	1060.11.085	50
Pg 11	8.5	12.0	21	21	6.0	1060.11.120	50
Pg 13	6.0	8.0	24	21	6.0	1060.13.080	50
Pg 13	8.0	11.0	24	21	6.0	1060.13.110	50
Pg 13	11.0	14.5	24	23	6.0	1060.13.145	50
Pg 16	6.0	8.0	24	23	6.0	1060.16.080	50
Pg 16	8.0	11.0	24	23	6.0	1060.16.110	50
Pg 16	11.0	14.5	24	23	6.0	1060.16.145	50
Pg 21	9.5	12.5	30	28	7.5	1060.21.125	25
Pg 21	12.5	16.0	30	28	7.5	1060.21.160	25
Pg 21	16.0	19.0	30	28	7.5	1060.21.190	25
Pg 29	19.0	23.0	38	28	8.0	1060.29.230	25
Pg 29	23.0	27.5	38	28	8.0	1060.29.275	25
Pg 36	26.0	30.5	50	32	8.0	1060.36.305	10
Pg 36	30.5	35.0	50	32	8.0	1060.36.350	10
Pg 42	33.0	37.0	55	34	10.0	1060.42.370	10
Pg 42	37.0	42.0	55	34	10.0	1060.42.420	10
Pg 48	37.0	43.0	65	37	11.0	1060.48.430	10
Pg 48	43.0	49.0	65	37	11.0	1060.48.490	10

Erhältlich mit Dichteinsatz gemäß EN 45545. Bei Anfragen oder Bestellung bitte ein F vor die Artikelnummer setzen.

Available with sealing inserts conformity with EN 45545. When placing an inquiry, prefix the article number by the capital F.

#### Progress MS



Zweiteiliger Dichteinsatz  
 durchgehend isolierend

Two-piece sealing insert  
 overall length insulated

G	>Ø< min mm	>Ø< max mm		H mm	L mm	Art.-Nr.   Art. No.	
Pg 9	6.0	10.5	18	22	6.0	1060.09	50
Pg 11	5.5	12.0	21	21	6.0	1060.11	50
Pg 13	8.0	14.5	24	23	6.0	1060.13	50
Pg 16	8.0	14.5	24	23	6.0	1060.16	50
Pg 21	12.5	19.0	30	28	7.5	1060.21	25
Pg 29	19.0	27.5	38	28	8.0	1060.29	25
Pg 36	26.0	35.0	50	32	8.0	1060.36	10
Pg 42	33.0	42.0	55	34	10.0	1060.42	10
Pg 48	37.0	49.0	65	37	11.0	1060.48	10

Erhältlich mit Dichteinsatz gemäß EN 45545. Bei Anfragen oder Bestellung bitte ein F vor die Artikelnummer setzen.

Available with sealing inserts conformity with EN 45545. When placing an inquiry, prefix the article number by the capital F.

# Kabelverschraubungen Progress® Messing

## Cable glands Progress® nickel-plated brass

### Kurzes Anschlussgewinde Pg | Short entry thread Pg

Material: Messing vernickelt  
 Dichtung: TPE  
 O-Ring : NBR  
 Einsatztemperatur: -40°C / +100°C  
 Schutzart: IP 68 (bis 10 bar)  
 Weitere Schutzart: IP 69K

Material: Nickel-plated brass  
 Seal: TPE  
 O-ring : NBR  
 Temperature range: -40°C / +100°C  
 Protection class: IP 68 (up to 10 bar)  
 Further protection: IP 69K

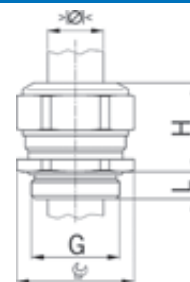



#### Progress MS

Einteiliger Dichteinsatz  
 nicht durchgehend isolierend

One-piece sealing insert  
 not overall length insulated



G	> Ø < min mm	> Ø < max mm	 mm	H mm	L mm	Art.-Nr.   Art. No.	
Pg 7	3.5	5.0	15	17	6.0	1000.07.050	50
Pg 7	5.0	6.5	15	17	6.0	1000.07.065	50
Pg 7	6.5	8.0	15	17	6.0	1000.07.080	50
Pg 9	3.5	4.5	18	20	6.0	1000.09.045	50
Pg 9	4.5	6.0	18	20	6.0	1000.09.060	50
Pg 9	6.0	8.0	18	20	6.0	1000.09.080	50
Pg 9	8.0	10.5	18	22	6.0	1000.09.105	50
Pg 11	4.0	5.5	21	21	6.0	1000.11.055	50
Pg 11	5.5	8.5	21	21	6.0	1000.11.085	50
Pg 11	8.5	12.0	21	21	6.0	1000.11.120	50
Pg 13	6.0	8.0	24	21	6.0	1000.13.080	50
Pg 13	8.0	11.0	24	21	6.0	1000.13.110	50
Pg 13	11.0	15.0	24	23	6.0	1000.13.150	50
Pg 16	6.0	8.0	24	23	6.0	1000.16.080	50
Pg 16	8.0	11.0	24	23	6.0	1000.16.110	50
Pg 16	11.0	15.0	24	23	6.0	1000.16.150	50
Pg 21	9.5	12.5	30	28	7.5	1000.21.125	25
Pg 21	12.5	16.0	30	28	7.5	1000.21.160	25
Pg 21	16.0	20.5	30	28	7.5	1000.21.205	25
Pg 29	16.0	19.0	38	28	8.0	1000.29.190	25
Pg 29	19.0	23.0	38	28	8.0	1000.29.230	25
Pg 29	23.0	27.5	38	28	8.0	1000.29.275	25
Pg 36	21.5	26.0	50	32	8.0	1000.36.260	10
Pg 36	26.0	30.5	50	32	8.0	1000.36.305	10
Pg 36	30.5	35.0	50	32	8.0	1000.36.350	10
Pg 42	29.0	33.0	55	34	10.0	1000.42.330	10
Pg 42	33.0	37.0	55	34	10.0	1000.42.370	10
Pg 42	37.0	42.0	55	34	10.0	1000.42.420	10
Pg 48	32.0	37.0	65	37	11.0	1000.48.370	10
Pg 48	37.0	43.0	65	37	11.0	1000.48.430	10
Pg 48	43.0	49.0	65	37	11.0	1000.48.490	10



Erhältlich mit Dichteinsatz gemäß EN 45545. Bei Anfragen oder Bestellung bitte ein F vor die Artikelnummer setzen.

Available with sealing inserts conformity with EN 45545. When placing an inquiry, prefix the article number by the capital F.



# Kabelverschraubungen Progress® Messing

## Cable glands Progress® nickel-plated brass

### Kurzes Anschlussgewinde Pg | Short entry thread Pg

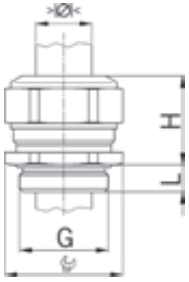

Material: Messing vernickelt  
 Dichtung: TPE  
 O-Ring : NBR  
 Einsatztemperatur: -40°C / +100°C  
 Schutzart: IP 68 (bis 10 bar)  
 Weitere Schutzart: IP 69K

Material: Nickel-plated brass  
 Seal: TPE  
 O-ring : NBR  
 Temperature range: -40°C / +100°C  
 Protection class: IP 68 (up to 10 bar)  
 Further protection: IP 69K



#### Progress MS

Zweiteiliger Dichteinsatz  
 nicht durchgehend isolierend

Two-piece sealing insert  
 not overall length insulated



G	> Ø < min mm	> Ø < max mm		H mm	L mm	Art.-Nr.   Art. No.	
<b>Pg 9</b>	6.0	10.5	18	22	6.0	<b>1000.09</b>	50
<b>Pg 11</b>	5.5	12.0	21	21	6.0	<b>1000.11</b>	50
<b>Pg 13</b>	8.0	15.0	24	23	6.0	<b>1000.13</b>	50
<b>Pg 16</b>	8.0	15.0	24	23	6.0	<b>1000.16</b>	50
<b>Pg 21</b>	12.5	20.5	30	28	7.5	<b>1000.21</b>	25
<b>Pg 29</b>	19.0	27.5	38	28	8.0	<b>1000.29</b>	25
<b>Pg 36</b>	26.0	35.0	50	32	8.0	<b>1000.36</b>	10
<b>Pg 42</b>	33.0	42.0	55	34	10.0	<b>1000.42</b>	10
<b>Pg 48</b>	37.0	49.0	65	37	11.0	<b>1000.48</b>	10

Erhältlich mit Dichteinsatz gemäß EN 45545. Bei Anfragen oder Bestellung bitte ein F vor die Artikelnummer setzen.

Available with sealing inserts conformity with EN 45545. When placing an inquiry, prefix the article number by the capital F.

# Kabelverschraubungen Progress® Messing

## Cable glands Progress® nickel-plated brass

### Langes Anschlussgewinde Pg | Long entry thread Pg

Material: Messing vernickelt  
 Dichtung: TPE  
 O-Ring : NBR  
 Einsatztemperatur: -40°C / +100°C  
 Schutzart: IP 68 (bis 10 bar)  
 Weitere Schutzart: IP 69K

Material: Nickel-plated brass  
 Seal: TPE  
 O-ring : NBR  
 Temperature range: -40°C / +100°C  
 Protection class: IP 68 (up to 10 bar)  
 Further protection: IP 69K



#### Progress MS



Einteiliger Dichteinsatz  
 durchgehend isolierend

One-piece sealing insert  
 overall length insulated

G	>Ø< min mm	>Ø< max mm		H mm	L mm	Art.-Nr.   Art. No.	
Pg 7	5.0	6.5	15	17	10	1160.07.065	50
Pg 7	6.5	7.5	15	17	10	1160.07.075	50
Pg 9	8.0	10.5	18	22	10	1160.09.105	50
Pg 11	8.5	12.0	21	21	10	1160.11.120	50
Pg 13	11.0	14.5	24	23	10	1160.13.145	50
Pg 16	11.0	14.5	24	23	10	1160.16.145	50
Pg 21	16.0	19.0	30	28	12	1160.21.190	25
Pg 29	23.0	27.5	38	28	12	1160.29.275	25
Pg 36	30.5	35.0	50	32	15	1160.36.350	10
Pg 42	37.0	42.0	55	32	15	1160.42.420	10
Pg 48	43.0	49.0	65	37	15	1160.48.490	10



Erhältlich mit Dichteinsatz gemäß EN 45545. Bei Anfragen oder Bestellung bitte ein F vor die Artikelnummer setzen.

Available with sealing inserts conformity with EN 45545. When placing an inquiry, prefix the article number by the capital F.

#### Progress MS



Zweiteiliger Dichteinsatz  
 durchgehend isolierend

Two-piece sealing insert  
 overall length insulated

G	>Ø< min mm	>Ø< max mm		H mm	L mm	Art.-Nr.   Art. No.	
Pg 9	6.0	10.5	18	22	10	1160.09	50
Pg 11	5.5	12.0	21	21	10	1160.11	50
Pg 13	8.0	14.5	24	23	10	1160.13	50
Pg 16	8.0	14.5	24	23	10	1160.16	50
Pg 21	12.5	19.0	30	28	12	1160.21	25
Pg 29	19.0	27.5	38	28	12	1160.29	25
Pg 36	26.0	35.0	50	32	15	1160.36	10
Pg 42	33.0	42.0	55	34	15	1160.42	10
Pg 48	37.0	49.0	65	37	15	1160.48	10



Erhältlich mit Dichteinsatz gemäß EN 45545. Bei Anfragen oder Bestellung bitte ein F vor die Artikelnummer setzen.

Available with sealing inserts conformity with EN 45545. When placing an inquiry, prefix the article number by the capital F.

# Kabelverschraubungen Progress® Messing

## Cable glands Progress® nickel-plated brass

### Langes Anschlussgewinde Pg | Long entry thread Pg

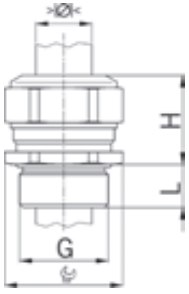

Material: Messing vernickelt  
 Dichtung: TPE  
 O-Ring : NBR  
 Einsatztemperatur: -40°C / +100°C  
 Schutzart: IP 68 (bis 10 bar)  
 Weitere Schutzart: IP 69K

Material: Nickel-plated brass  
 Seal: TPE  
 O-ring : NBR  
 Temperature range: -40°C / +100°C  
 Protection class: IP 68 (up to 10 bar)  
 Further protection: IP 69K





#### Progress MS



Einteiliger Dichteinsatz  
 nicht durchgehend isolierend

One-piece sealing insert  
 not overall length insulated

G	>Ø< min mm	>Ø< max mm	 mm	H mm	L mm	Art.-Nr.   Art. No.	
Pg 7	3.5	5.0	15	17	10	1100.07.050	50
Pg 7	5.0	6.5	15	17	10	1100.07.065	50
Pg 7	6.5	8.0	15	17	10	1100.07.080	50
Pg 9	3.5	4.5	18	20	10	1100.09.045	50
Pg 9	4.5	6.0	18	20	10	1100.09.060	50
Pg 9	6.0	8.0	18	20	10	1100.09.080	50
Pg 9	8.0	10.5	18	22	10	1100.09.105	50
Pg 11	4.0	5.5	21	21	10	1100.11.055	50
Pg 11	5.5	8.5	21	21	10	1100.11.085	50
Pg 11	8.5	12.0	21	21	10	1100.11.120	50
Pg 13	6.0	8.0	24	21	10	1100.13.080	50
Pg 13	8.0	11.0	24	21	10	1100.13.110	50
Pg 13	11.0	15.0	24	23	10	1100.13.150	50
Pg 16	6.0	8.0	24	23	10	1100.16.080	50
Pg 16	8.0	11.0	24	23	10	1100.16.110	50
Pg 16	11.0	15.0	24	23	10	1100.16.150	50
Pg 21	9.5	12.5	30	28	12	1100.21.125	25
Pg 21	12.5	16.0	30	28	12	1100.21.160	25
Pg 21	16.0	20.5	30	28	12	1100.21.205	25
Pg 29	16.0	19.0	38	28	12	1100.29.190	25
Pg 29	19.0	23.0	38	28	12	1100.29.230	25
Pg 29	23.0	27.5	38	28	12	1100.29.275	25
Pg 36	21.5	26.0	50	32	15	1100.36.260	10
Pg 36	26.0	30.5	50	32	15	1100.36.305	10
Pg 36	30.5	35.0	50	32	15	1100.36.350	10
Pg 42	29.0	33.0	55	34	15	1100.42.330	10
Pg 42	33.0	37.0	55	34	15	1100.42.370	10
Pg 42	37.0	42.0	55	34	15	1100.42.420	10
Pg 48	32.0	37.0	65	37	15	1100.48.370	10
Pg 48	37.0	43.0	65	37	15	1100.48.430	10
Pg 48	43.0	49.0	65	37	15	1100.48.490	10

Erhältlich mit Dichteinsatz gemäß EN 45545. Bei Anfragen oder Bestellung bitte ein F vor die Artikelnummer setzen.

Available with sealing inserts conformity with EN 45545. When placing an inquiry, prefix the article number by the capital F.

# Kabelverschraubungen Progress® Messing

## Cable glands Progress® nickel-plated brass

### Langes Anschlussgewinde Pg | Long entry thread Pg

Material: Messing vernickelt  
 Dichtung: TPE  
 O-Ring : NBR  
 Einsatztemperatur: -40°C / +100°C  
 Schutzart: IP 68 (bis 10 bar)  
 Weitere Schutzart: IP 69K

Material: Nickel-plated brass  
 Seal: TPE  
 O-ring : NBR  
 Temperature range: -40°C / +100°C  
 Protection class: IP 68 (up to 10 bar)  
 Further protection: IP 69K

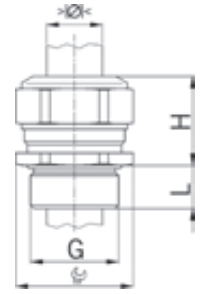



#### Progress MS



Zweiteiliger Dichteinsatz  
 nicht durchgehend isolierend

Two-piece sealing insert  
 not overall length insulated

G	> Ø < min mm	> Ø < max mm	 mm	H mm	L mm	Art.-Nr.   Art. No.	
<b>Pg 9</b>	6.0	10.5	18	22	10	<b>1100.09</b>	50
<b>Pg 11</b>	5.5	12.0	21	21	10	<b>1100.11</b>	50
<b>Pg 13</b>	8.0	15.0	24	23	10	<b>1100.13</b>	50
<b>Pg 16</b>	8.0	15.0	24	23	10	<b>1100.16</b>	50
<b>Pg 21</b>	12.5	20.5	30	28	12	<b>1100.21</b>	25
<b>Pg 29</b>	19.0	27.5	38	28	12	<b>1100.29</b>	25
<b>Pg 36</b>	26.0	35.0	50	32	15	<b>1100.36</b>	10
<b>Pg 42</b>	33.0	42.0	55	34	15	<b>1100.42</b>	10
<b>Pg 48</b>	37.0	49.0	65	37	15	<b>1100.48</b>	10

Erhältlich mit Dichteinsatz gemäß EN 45545. Bei Anfragen oder Bestellung bitte ein F vor die Artikelnummer setzen.

Available with sealing inserts conformity with EN 45545. When placing an inquiry, prefix the article number by the capital F.





# Kabelverschraubungen Progress® Messing

## Cable glands Progress® nickel-plated brass

### Anschlussgewinde NPT | Entry thread NPT

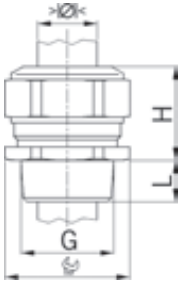

Material: Messing vernickelt  
 Dichtung: TPE  
 Einsatztemperatur: -40°C / +100°C  
 Schutzart: IP 68 (bis 10 bar)  
 Weitere Schutzart: IP 69K  
 Gewinde: IP 68, wenn Anschlussgewinde abgedichtet

Material: Nickel-plated brass  
 Seal: TPE  
 Temperature range: -40°C / +100°C  
 Protection class: IP 68 (up to 10 bar)  
 Further protection: IP 69K  
 Entry thread: IP 68, if the entry thread is sealed



#### Progress NPT

Einteiliger Dichteinsatz  
 nicht durchgehend isolierend

One-piece sealing insert  
 not overall length insulated

G	>Ø< min mm	>Ø< max mm		H mm	L mm	Art.-Nr.   Art. No.	
NPT 1/8"	3.0	4.0	13	15	8	1000.1/8NPT.040	50
NPT 1/8"	4.0	6.0	13	15	8	1000.1/8NPT.060	50
NPT 1/4"	3.5	5.0	15	17	12	1000.1/4NPT.050	50
NPT 1/4"	5.0	6.5	15	17	12	1000.1/4NPT.065	50
NPT 1/4"	6.5	8.0	15	17	12	1000.1/4NPT.080	50
NPT 3/8"	3.5	4.5	18	20	12	1000.3/8NPT.045	50
NPT 3/8"	4.5	6.0	18	20	12	1000.3/8NPT.060	50
NPT 3/8"	6.0	8.0	18	20	12	1000.3/8NPT.080	50
NPT 3/8"	8.0	10.5	18	22	12	1000.3/8NPT.105	50
NPT 1/2"	6.0	8.0	24	21	15	1000.1/2NPT.080	50
NPT 1/2"	8.0	11.0	24	21	15	1000.1/2NPT.110	50
NPT 1/2"	11.0	15.0	24	23	15	1000.1/2NPT.150	50
NPT 3/4"	9.5	12.5	30	28	15	1000.3/4NPT.125	25
NPT 3/4"	12.5	16.0	30	28	15	1000.3/4NPT.160	25
NPT 3/4"	16.0	20.5	30	28	15	1000.3/4NPT.205	25
NPT 1"	14.0	17.0	36	28	20	1000.1NPT.170	25
NPT 1"	17.0	21.0	36	28	20	1000.1NPT.210	25
NPT 1"	21.0	25.5	36	28	20	1000.1NPT.255	25
NPT 1 1/4"	20.0	24.0	46	31	20	1000.11/4NPT.240	10
NPT 1 1/4"	24.0	28.5	46	31	20	1000.11/4NPT.285	10
NPT 1 1/4"	28.5	33.0	46	31	20	1000.11/4NPT.330	10
NPT 1 1/2"	29.0	33.0	55	34	22	1000.11/2NPT.330	10
NPT 1 1/2"	33.0	37.0	55	34	22	1000.11/2NPT.370	10
NPT 1 1/2"	37.0	41.0	55	34	22	1000.11/2NPT.410	10
NPT 2"	35.0	40.0	70	37	22	1000.2NPT.400	5
NPT 2"	40.0	46.0	70	37	22	1000.2NPT.460	5
NPT 2"	46.0	52.0	70	37	22	1000.2NPT.520	5



#### Progress NPT

Zweiteiliger Dichteinsatz  
 nicht durchgehend isolierend

Two-piece sealing insert  
 not overall length insulated

G	>Ø< min mm	>Ø< max mm		H mm	L mm	Art.-Nr.   Art. No.	
NPT 3/8"	6.0	10.5	18	22	12	1000.3/8NPT	50
NPT 1/2"	8.0	15.0	24	23	15	1000.1/2NPT	50
NPT 3/4"	12.5	20.5	30	28	15	1000.3/4NPT	25
NPT 1"	17.0	25.5	36	28	20	1000.1NPT	25
NPT 1 1/4"	24.0	33.0	46	31	20	1000.11/4NPT	10
NPT 1 1/2"	33.0	41.0	55	34	22	1000.11/2NPT	10
NPT 2"	40.0	52.0	70	37	22	1000.2NPT	5

# Kabelverschraubungen Progress® Messing

## Cable glands Progress® nickel-plated brass

### Anschlussgewinde Gasrohr | Gas-pipe entry thread

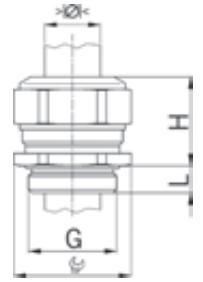

Material: Messing vernickelt  
 Dichtung: TPE  
 O-Ring : NBR  
 Einsatztemperatur: -40°C / +100°C  
 Schutzart: IP 68

Material: Nickel-plated brass  
 Seal: TPE  
 O-ring : NBR  
 Temperature range: -40°C / +100°C  
 Protection class: IP 68



Zweiteiliger Dichteinsatz  
 nicht durchgehend isolierend

Two-piece sealing insert  
 not overall length insulated

G	>Ø< min mm	>Ø< max mm		H mm	L mm	i info	Art.-Nr.   Art. No.	
G 3/8"	5.5	12.0	21	21	6	-	1000.3/8G	50
G 1/2"	8.0	15.0	24	23	8	-	1000.1/2G	50
G 3/4"	12.5	20.5	30	28	10	-	1000.3/4G	25
G 1"	17.0	25.5	36	28	11	-	1000.1G	25
G 1 1/2"	25.0	35.0	55/50	32	12	-	1000.11/2G	10
G 2"	37.0	49.0	65	37	12	-	1000.2G	10
G 2 1/2"	45.0	50.0	80	38	18	1	1000.21/2G.500	1
G 2 1/2"	50.0	56.0	80	38	18	1	1000.21/2G.560	1
G 3"	56.0	63.0	80	38	18	1	1000.3G.630	1
G 3"	63.0	70.0	95	40	18	1	1000.3G.700	1

1 = Einteiliger Dichteinsatz

1 = One-piece sealing insert



# Kabelverschraubungen Progress® Messing für hohe Temperaturen

## Cable glands Progress® nickel-plated brass for high temperature applications

Langes Anschlussgewinde metrisch | Long entry thread metric

Material: Messing vernickelt  
 Dichtung: FPM  
 O-Ring : FPM  
 Zugentlastung: Ausführung A  
 Einsatztemperatur: -40°C / +200°C  
 Schutzart: IP 68 (bis 10 bar)  
 Weitere Schutzart: IP 69K

Material: Nickel-plated brass  
 Seal: FPM  
 O-ring : FPM  
 Strain relief: Version A  
 Temperature range: -40°C / +200°C  
 Protection class: IP 68 (up to 10 bar)  
 Further protection: IP 69K

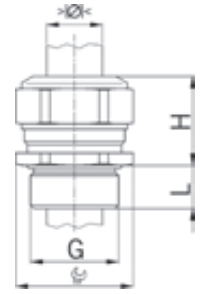

### Progress MS HT



Einteiliger Dichteinsatz  
 nicht durchgehend isolierend

One-piece sealing insert  
 not overall length insulated

G	>Ø< min mm	>Ø< max mm		H mm	L mm	i info	Art.-Nr.   Art. No.	
M6x1.0	2.0	2.5	8	12	8	1	1100.06.91.025	50
M6x1.0	2.5	3.0	8	12	8	1	1100.06.91.030	50
M6x1.0	3.0	3.5	8	12	8	1	1100.06.91.035	50
M8x1.25	2.5	3.5	11	14	10	1	1100.08.91.035	50
M8x1.25	3.5	5.0	11	14	10	1	1100.08.91.050	50
M10x1.5	3.0	4.0	13	15	10	1	1100.10.91.040	50
M10x1.5	4.0	6.0	13	15	10	1	1100.10.91.060	50
M12x1.5	3.5	5.0	15	17	10	-	1100.12.91.050	50
M12x1.5	5.0	6.5	15	17	10	-	1100.12.91.065	50
M12x1.5	6.5	8.0	15	17	10	-	1100.12.91.080	50
M16x1.5	8.0	10.5	18	22	10	-	1100.17.91.105	50
M20x1.5	11.0	15.0	24	23	10	-	1100.20.91.150	50
M25x1.5	16.0	20.5	30	28	11	-	1100.25.91.205	25
M32x1.5	21.0	25.5	36	28	13	-	1100.32.91.255	25
M40x1.5	28.5	33.0	46	31	13	-	1100.40.91.330	10
M50x1.5	37.0	42.0	55	34	14	-	1100.50.91.420	10
M63x1.5	46.0	52.0	70	37	14	-	1100.63.91.520	5

1 = Metrisches Regelgewinde

1 = Metric coarse-pitch thread



### Progress MS HT



Zweiteiliger Dichteinsatz  
 nicht durchgehend isolierend

Two-piece sealing insert  
 not overall length insulated

G	>Ø< min mm	>Ø< max mm		H mm	L mm	Art.-Nr.   Art. No.	
M16x1.5	6.0	10.5	18	22	10	1100.17.92	50
M20x1.5	8.0	15.0	24	23	10	1100.20.92	50
M25x1.5	12.5	20.5	30	28	11	1100.25.92	25
M32x1.5	17.0	25.5	36	28	13	1100.32.92	25
M40x1.5	24.0	33.0	46	31	13	1100.40.92	10
M50x1.5	33.0	42.0	55	34	14	1100.50.92	10
M63x1.5	40.0	52.0	70	37	14	1100.63.92	5





# Kabelverschraubungen Progress® Messing für hohe Temperaturen

## Cable glands Progress® nickel-plated brass for high temperature applications

### Kurzes Anschlussgewinde Pg | Short entry thread Pg

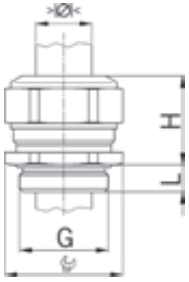

Material: Messing vernickelt  
 Dichtung: FPM  
 O-Ring : FPM  
 Einsatztemperatur: -40°C / +200°C  
 Schutzart: IP 68 (bis 10 bar)  
 Weitere Schutzart: IP 69K

Material: Nickel-plated brass  
 Seal: FPM  
 O-ring : FPM  
 Temperature range: -40°C / +200°C  
 Protection class: IP 68 (up to 10 bar)  
 Further protection: IP 69K



#### Progress MS HT



Einteiliger Dichteinsatz  
 nicht durchgehend isolierend

One-piece sealing insert  
 not overall length insulated

G	> Ø < min mm	> Ø < max mm	PG	H mm	L mm	Art.-Nr.   Art. No.	
Pg 7	3.5	5.0	15	17	6	1000.07.91.050	50
Pg 7	5.0	6.5	15	17	6	1000.07.91.065	50
Pg 7	6.5	8.0	15	17	6	1000.07.91.080	50
Pg 9	8.0	10.5	18	22	6	1000.09.91.105	50
Pg 11	8.5	12.0	21	21	6	1000.11.91.120	50
Pg 13	11.0	15.0	24	23	6	1000.13.91.150	50
Pg 16	11.0	15.0	24	23	6	1000.16.91.150	50
Pg 21	16.0	20.5	30	28	7	1000.21.91.205	25
Pg 29	23.0	27.5	38	28	8	1000.29.91.275	25
Pg 36	30.5	35.0	50	32	8	1000.36.91.350	10
Pg 42	37.0	42.0	55	34	10	1000.42.91.420	10
Pg 48	43.0	49.0	65	37	11	1000.48.91.490	10



#### Progress MS HT



Zweiteiliger Dichteinsatz  
 nicht durchgehend isolierend

Two-piece sealing insert  
 not overall length insulated

G	> Ø < min mm	> Ø < max mm	PG	H mm	L mm	Art.-Nr.   Art. No.	
Pg 9	6.0	10.5	18	22	6	1000.09.92	50
Pg 11	5.5	12.0	21	21	6	1000.11.92	50
Pg 13	8.0	15.0	24	23	6	1000.13.92	50
Pg 16	8.0	15.0	24	23	6	1000.16.92	50
Pg 21	12.5	20.5	30	28	7	1000.21.92	25
Pg 29	19.0	27.5	38	28	8	1000.29.92	25
Pg 36	26.0	35.0	50	32	8	1000.36.92	10
Pg 42	33.0	42.0	55	34	10	1000.42.92	10
Pg 48	37.0	49.0	65	37	11	1000.48.92	10

# Kabelverschraubungen Progress® Messing für hohe Temperaturen

## Cable glands Progress® nickel-plated brass for high temperature applications

### Langes Anschlussgewinde Pg | Long entry thread Pg

Material: Messing vernickelt  
 Dichtung: FPM  
 O-Ring : FPM  
 Einsatztemperatur: -40°C / +200°C  
 Schutzart: IP 68 (bis 10 bar)  
 Weitere Schutzart: IP 69K

Material: Nickel-plated brass  
 Seal: FPM  
 O-ring : FPM  
 Temperature range: -40°C / +200°C  
 Protection class: IP 68 (up to 10 bar)  
 Further protection: IP 69K

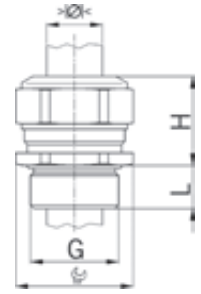

#### Progress MS HT

Einteiliger Dichteinsatz nicht durchgehend isolierend		One-piece sealing insert not overall length insulated				Art.-Nr.   Art. No.	
G	>Ø< min mm	>Ø< max mm		H mm	L mm		
Pg 7	3.5	5.0	15	17	10	1100.07.91.050	50
Pg 7	5.0	6.5	15	17	10	1100.07.91.065	50
Pg 7	6.5	8.0	15	17	10	1100.07.91.080	50
Pg 9	8.0	10.5	18	22	10	1100.09.91.105	50
Pg 11	8.5	12.0	21	21	10	1100.11.91.120	50
Pg 13	11.0	15.0	24	23	10	1100.13.91.150	50
Pg 16	11.0	15.0	24	23	10	1100.16.91.150	50
Pg 21	16.0	20.5	30	28	12	1100.21.91.205	25
Pg 29	23.0	27.5	38	28	12	1100.29.91.275	25
Pg 36	30.5	35.0	50	32	15	1100.36.91.350	10
Pg 42	37.0	42.0	55	34	15	1100.42.91.420	10
Pg 48	43.0	49.0	65	37	15	1100.48.91.490	10



#### Progress MS HT

Zweiteiliger Dichteinsatz nicht durchgehend isolierend		Two-piece sealing insert not overall length insulated				Art.-Nr.   Art. No.	
G	>Ø< min mm	>Ø< max mm		H mm	L mm		
Pg 9	6.0	10.5	18	22	10	1100.09.92	50
Pg 11	5.5	12.0	21	21	10	1100.11.92	50
Pg 13	8.0	15.0	24	23	10	1100.13.92	50
Pg 16	8.0	15.0	24	23	10	1100.16.92	50
Pg 21	12.5	20.5	30	28	12	1100.21.92	25
Pg 29	19.0	27.5	38	28	12	1100.29.92	25
Pg 36	26.0	35.0	50	32	15	1100.36.92	10
Pg 42	33.0	42.0	55	34	15	1100.42.92	10
Pg 48	37.0	49.0	65	37	15	1100.48.92	10



# Kabelverschraubungen Progress® Messing für mehrere Kabel

## Cable glands Progress® nickel-plated brass for installation of multiple cables

### Kurzes Anschlussgewinde metrisch | Short entry thread metric

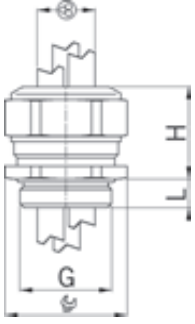

Material: Messing vernickelt  
 Dichtung: TPE  
 O-Ring : NBR  
 Zugentlastung: Ausführung A  
 Einsatztemperatur: -40°C / +100°C  
 Schutzart: IP 68

Material: Nickel-plated brass  
 Seal: TPE  
 O-ring : NBR  
 Strain relief: Version A  
 Temperature range: -40°C / +100°C  
 Protection class: IP 68



### Progress MS Multi



Einteiliger Dichteinsatz  
 nicht durchgehend isolierend

One-piece sealing insert  
 not overall length insulated

G	> Ø < min mm	> Ø < max mm			H mm	L mm	Art.-Nr.   Art. No.	
M16x1.5	2.0	3.0	2	18	22	5	1310.17.2.030	50
M16x1.5	2.5	4.0	2	18	22	5	1310.17.2.040	50
M16x1.5	3.5	5.0	2	18	22	5	1310.17.2.050	50
M20x1.5	3.5	5.0	2	24	23	6	1310.20.2.050	50
M20x1.5	4.5	6.0	2	24	23	6	1310.20.2.060	50
M20x1.5	5.5	7.5	2	24	23	6	1310.20.2.075	50
M20x1.5	3.5	5.0	3	24	23	6	1310.20.3.050	50
M20x1.5	4.5	6.0	3	24	23	6	1310.20.3.060	50
M20x1.5	5.2	6.5	3	24	23	6	1310.20.3.065	50
M20x1.5	3.5	5.0	4	24	23	6	1310.20.4.050	50
M20x1.5	4.5	6.0	4	24	23	6	1310.20.4.060	50
M25x1.5	5.0	7.0	2	30	28	7	1310.25.2.070	25
M25x1.5	6.7	9.0	2	30	28	7	1310.25.2.090	25
M25x1.5	7.7	10.0	2	30	28	7	1310.25.2.100	25
M25x1.5	5.5	7.0	3	30	28	7	1310.25.3.070	25
M25x1.5	6.8	9.0	3	30	28	7	1310.25.3.090	25
M25x1.5	5.5	7.0	4	30	28	7	1310.25.4.070	25
M25x1.5	4.8	6.0	6	30	28	7	1310.25.6.060	25
M32x1.5	9.0	11.5	2	36	28	8	1310.32.2.115	25
M32x1.5	7.0	9.0	3	36	28	8	1310.32.3.090	25
M32x1.5	8.5	10.5	3	36	28	8	1310.32.3.105	25
M32x1.5	7.0	9.0	4	36	28	8	1310.32.4.090	25
M32x1.5	5.8	7.0	6	36	28	8	1310.32.6.070	25

Weitere Ausführungen und Anschlussgewinde auf Anfrage

Further versions and entry threads are available upon request.

Erhältlich mit Dichteinsatz gemäß EN 45545. Bei Anfragen oder Bestellung bitte ein F vor die Artikelnummer setzen.

Available with sealing inserts conformity with EN 45545. When placing an inquiry, prefix the article number by the capital F.

# Kabelverschraubungen Progress® Messing für mehrere Kabel Cable glands Progress® nickel-plated brass for installation of multiple cables

Langes Anschlussgewinde metrisch | Long entry thread metric

Material: Messing vernickelt  
Dichtung: TPE  
O-Ring : NBR  
Zugentlastung: Ausführung A  
Einsatztemperatur: -40°C / +100°C  
Schutzart: IP 68

Material: Nickel-plated brass  
Seal: TPE  
O-ring : NBR  
Strain relief: Version A  
Temperature range: -40°C / +100°C  
Protection class: IP 68

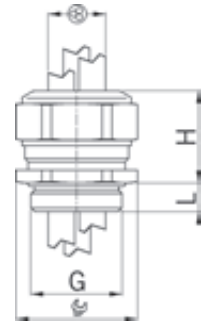

## Progress MS Multi



Einteiliger Dichteinsatz  
nicht durchgehend isolierend

One-piece sealing insert  
not overall length insulated

G	> Ø < min mm	> Ø < max mm			H mm	L mm	Art.-Nr.   Art. No.	
M16x1.5	2.0	3.0	2	18	22	10	1311.17.2.030	50
M16x1.5	2.5	4.0	2	18	22	10	1311.17.2.040	50
M16x1.5	3.5	5.0	2	18	22	10	1311.17.2.050	50
M20x1.5	3.5	5.0	2	24	23	10	1311.20.2.050	50
M20x1.5	4.5	6.0	2	24	23	10	1311.20.2.060	50
M20x1.5	5.5	7.5	2	24	23	10	1311.20.2.075	50
M20x1.5	3.5	5.0	3	24	23	10	1311.20.3.050	50
M20x1.5	4.5	6.0	3	24	23	10	1311.20.3.060	50
M20x1.5	5.2	6.5	3	24	23	10	1311.20.3.065	50
M20x1.5	3.5	5.0	4	24	23	10	1311.20.4.050	50
M20x1.5	4.5	6.0	4	24	23	10	1311.20.4.060	50
M25x1.5	5.0	7.0	2	30	28	11	1311.25.2.070	25
M25x1.5	6.7	9.0	2	30	28	11	1311.25.2.090	25
M25x1.5	7.7	10.0	2	30	28	11	1311.25.2.100	25
M25x1.5	5.5	7.0	3	30	28	11	1311.25.3.070	25
M25x1.5	6.8	9.0	3	30	28	11	1311.25.3.090	25
M25x1.5	5.5	7.0	4	30	28	11	1311.25.4.070	25
M25x1.5	4.8	6.0	6	30	28	11	1311.25.6.060	25
M32x1.5	9.0	11.5	2	36	28	13	1311.32.2.115	25
M32x1.5	7.0	9.0	3	36	28	13	1311.32.3.090	25
M32x1.5	8.5	10.5	3	36	28	13	1311.32.3.105	25
M32x1.5	7.0	9.0	4	36	28	13	1311.32.4.090	25
M32x1.5	5.8	7.0	6	36	28	13	1311.32.6.070	25



Weitere Ausführungen und Anschlussgewinde auf Anfrage

Further versions and entry threads are available upon request.

Erhältlich mit Dichteinsatz gemäß EN 45545. Bei Anfragen oder Bestellung bitte ein F vor die Artikelnummer setzen.

Available with sealing inserts conformity with EN 45545. When placing an inquiry, prefix the article number by the capital F.



# Kabelverschraubungen Progress® Messing für mehrere Kabel

## Cable glands Progress® nickel-plated brass for installation of multiple cables

### Kurzes Anschlussgewinde Pg | Short entry thread Pg

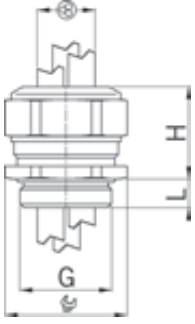

Material: Messing vernickelt  
 Dichtung: TPE  
 O-Ring : NBR  
 Einsatztemperatur: -40°C / +100°C  
 Schutzart: IP 68

Material: Nickel-plated brass  
 Seal: TPE  
 O-ring : NBR  
 Temperature range: -40°C / +100°C  
 Protection class: IP 68



### Progress MS Multi



Einteiliger Dichteinsatz  
 nicht durchgehend isolierend

One-piece sealing insert  
 not overall length insulated

G	> Ø < min mm	> Ø < max mm	⊗	⊗ mm	H mm	L mm	Art.-Nr.   Art. No.	⊞
Pg 9	2.0	3.0	2	18	22	6.0	1310.09.2.030	50
Pg 9	2.5	4.0	2	18	22	6.0	1310.09.2.040	50
Pg 9	3.5	5.0	2	18	22	6.0	1310.09.2.050	50
Pg 11	3.5	5.0	2	21	21	6.0	1310.11.2.050	50
Pg 11	4.5	6.0	2	21	21	6.0	1310.11.2.060	50
Pg 11	5.5	7.5	2	24	23	6.0	1310.11.2.075	50
Pg 11	3.5	5.0	3	21	21	6.0	1310.11.3.050	50
Pg 13	3.5	5.0	2	24	23	6.0	1310.13.2.050	50
Pg 13	4.5	6.0	2	24	23	6.0	1310.13.2.060	50
Pg 13	5.5	7.5	2	24	23	6.0	1310.13.2.075	50
Pg 13	3.5	5.0	3	24	23	6.0	1310.13.3.050	50
Pg 13	4.5	6.0	3	24	23	6.0	1310.13.3.060	50
Pg 13	5.2	6.5	3	24	23	6.0	1310.13.3.065	50
Pg 13	3.5	5.0	4	24	23	6.0	1310.13.4.050	50
Pg 13	4.5	6.0	4	24	23	6.0	1310.13.4.060	50
Pg 16	3.5	5.0	2	24	23	6.0	1310.16.2.050	50
Pg 16	4.5	6.0	2	24	23	6.0	1310.16.2.060	50
Pg 16	5.5	7.5	2	24	23	6.0	1310.16.2.075	50
Pg 16	6.7	9.0	2	30	28	6.0	1310.16.2.090	25
Pg 16	3.5	5.0	3	24	23	6.0	1310.16.3.050	50
Pg 16	4.5	6.0	3	24	23	6.0	1310.16.3.060	50
Pg 16	5.0	7.0	3	30	28	6.0	1310.16.3.070	25
Pg 16	3.5	5.0	4	24	23	6.0	1310.16.4.050	50
Pg 16	4.5	6.0	4	24	23	6.0	1310.16.4.060	50
Pg 16	5.5	7.0	4	30	28	6.0	1310.16.4.070	25
Pg 21	5.0	7.0	2	30	28	7.5	1310.21.2.070	25
Pg 21	6.7	9.0	2	30	28	7.5	1310.21.2.090	25
Pg 21	7.7	10.0	2	30	28	7.5	1310.21.2.100	25
Pg 21	9.0	11.5	2	36	28	7.5	1310.21.2.115	25
Pg 21	5.5	7.0	3	30	28	7.5	1310.21.3.070	25
Pg 21	6.8	9.0	3	30	28	7.5	1310.21.3.090	25
Pg 21	8.5	10.5	3	36	28	7.5	1310.21.3.105	25
Pg 21	5.5	7.0	4	30	28	7.5	1310.21.4.070	25
Pg 21	7.0	9.0	4	36	28	7.5	1310.21.4.090	25
Pg 21	4.8	6.0	6	30	28	7.5	1310.21.6.060	25
Pg 21	5.8	7.0	6	36	28	7.5	1310.21.6.070	25
Pg 29	7.5	9.0	3	38	28	8.0	1310.29.3.090	25

Weitere Ausführungen und Anschlussgewinde auf Anfrage

Further versions and entry threads are available upon request.

Erhältlich mit Dichteinsatz gemäß EN 45545. Bei Anfragen oder Bestellung bitte ein F vor die Artikelnummer setzen.

Available with sealing inserts conformity with EN 45545. When placing an inquiry, prefix the article number by the capital F.

# Kabelverschraubungen Progress® Messing für mehrere Kabel

## Cable glands Progress® nickel-plated brass for installation of multiple cables

Langes Anschlussgewinde Pg | Long entry thread Pg

Material: Messing vernickelt  
 Dichtung: TPE  
 O-Ring : NBR  
 Einsatztemperatur: -40°C / +100°C  
 Schutzart: IP 68

Material: Nickel-plated brass  
 Seal: TPE  
 O-ring : NBR  
 Temperature range: -40°C / +100°C  
 Protection class: IP 68

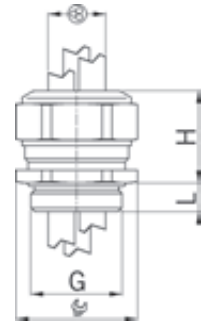

### Progress MS Multi

Einteiliger Dichteinsatz nicht durchgehend isolierend		One-piece sealing insert not overall length insulated							
G	>Ø< min mm	>Ø< max mm			H mm	L mm	Art.-Nr.   Art. No.		
Pg 9	2.0	3.0	2	18	22	10	1311.09.2.030	50	
Pg 9	2.5	4.0	2	18	22	10	1311.09.2.040	50	
Pg 9	3.5	5.0	2	18	22	10	1311.09.2.050	50	
Pg 11	3.5	5.0	2	21	21	10	1311.11.2.050	50	
Pg 11	4.5	6.0	2	21	21	10	1311.11.2.060	50	
Pg 11	5.5	7.5	2	24	23	10	1311.11.2.075	50	
Pg 11	3.5	5.0	3	21	21	10	1311.11.3.050	50	
Pg 13	3.5	5.0	2	24	23	10	1311.13.2.050	50	
Pg 13	4.5	6.0	2	24	23	10	1311.13.2.060	50	
Pg 13	5.5	7.5	2	24	23	10	1311.13.2.075	50	
Pg 13	3.5	5.0	3	24	23	10	1311.13.3.050	50	
Pg 13	4.5	6.0	3	24	23	10	1311.13.3.060	50	
Pg 13	5.2	6.5	3	24	23	10	1311.13.3.065	50	
Pg 13	3.5	5.0	4	24	23	10	1311.13.4.050	50	
Pg 13	4.5	6.0	4	24	23	10	1311.13.4.060	50	
Pg 16	3.5	5.0	2	24	23	10	1311.16.2.050	50	
Pg 16	4.5	6.0	2	24	23	10	1311.16.2.060	50	
Pg 16	5.5	7.5	2	24	23	10	1311.16.2.075	50	
Pg 16	6.7	9.0	2	30	28	10	1311.16.2.090	25	
Pg 16	3.5	5.0	3	24	23	10	1311.16.3.050	50	
Pg 16	4.5	6.0	3	24	23	10	1311.16.3.060	50	
Pg 16	5.0	7.0	3	30	28	10	1311.16.3.070	25	
Pg 16	3.5	5.0	4	24	23	10	1311.16.4.050	50	
Pg 16	4.5	6.0	4	24	23	10	1311.16.4.060	50	
Pg 16	5.5	7.0	4	30	28	10	1311.16.4.070	25	
Pg 21	5.0	7.0	2	30	28	12	1311.21.2.070	25	
Pg 21	6.7	9.0	2	30	28	12	1311.21.2.090	25	
Pg 21	7.7	10.0	2	30	28	12	1311.21.2.100	25	
Pg 21	9.0	11.5	2	36	28	12	1311.21.2.115	25	
Pg 21	5.5	7.0	3	30	28	12	1311.21.3.070	25	
Pg 21	6.8	9.0	3	30	28	12	1311.21.3.090	25	
Pg 21	8.5	10.5	3	36	28	12	1311.21.3.105	25	
Pg 21	5.5	7.0	4	30	28	12	1311.21.4.070	25	
Pg 21	7.0	9.0	4	36	28	12	1311.21.4.090	25	
Pg 21	4.8	6.0	6	30	28	12	1311.21.6.060	25	
Pg 21	5.8	7.0	6	36	28	12	1311.21.6.070	25	
Pg 29	7.5	9.0	3	38	28	12	1311.29.3.090	25	



Weitere Ausführungen und Anschlussgewinde auf Anfrage  
 Erhältlich mit Dichteinsatz gemäß EN 45545. Bei Anfragen oder Bestellung bitte ein F vor die Artikelnummer setzen.

Further versions and entry threads are available upon request.  
 Available with sealing inserts conformity with EN 45545. When placing an inquiry, prefix the article number by the capital F.

# Kabelverschraubungen Progress® Messing mit Dichteinsatz ohne Bohrung

## Cable glands Progress® nickel-plated brass with sealing insert without drilled hole

### Kurzes Anschlussgewinde metrisch | Short entry thread metric

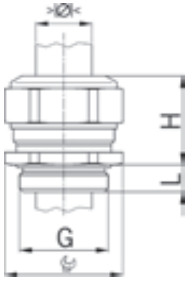

Material: Messing vernickelt  
 Dichtung: NBR, ohne Bohrung  
 O-Ring: NBR  
 Einsatztemperatur: -40°C / +100°C  
 Schutzart: IP 68 (bis 10 bar)  
 Weitere Schutzart: IP 69K

Material: Nickel-plated brass  
 Seal: NBR, without drilled hole  
 O-ring: NBR  
 Temperature range: -40°C / +100°C  
 Protection class: IP 68 (up to 10 bar)  
 Further protection: IP 69K



#### Progress MS NBR



Einteiliger Dichteinsatz ohne Bohrung  
 nicht durchgehend isolierend

One-piece solid sealing insert  
 not overall length insulated

G	> Ø < max mm		H mm	L mm	i info	Art.-Nr.   Art. No.	
M6x1.0	3.5	8	12	5	1	1000.06.30	50
M8x1.25	5.0	11	14	5	1	1000.08.30	50
M10x1.5	6.0	13	15	5	1	1000.10.30	50
M12x1.5	8.0	15	17	5	-	1000.12.30	50
M16x1.5	10.5	18	22	5	-	1000.17.30	50
M20x1.5	15.0	24	23	6	-	1000.20.30	50
M25x1.5	20.5	30	28	7	-	1000.25.30	25
M32x1.5	25.5	36	28	8	-	1000.32.30	25
M40x1.5	33.0	46	31	8	-	1000.40.30	10
M50x1.5	42.0	55	34	9	-	1000.50.30	10
M63x1.5	52.0	70	37	10	-	1000.63.30	5

1 = Metrisches Regelgewinde

1 = Metric coarse-pitch thread

Erhältlich mit Dichteinsatz gemäß EN 45545. Bei Anfragen oder Bestellung bitte ein F vor die Artikelnummer setzen.

Available with sealing inserts conformity with EN 45545. When placing an inquiry, prefix the article number by the capital F.

#### Technischer Hinweis

#### Technical note

Dichteinsätze ohne Bohrung lassen sich gut bearbeiten, wenn sie vorher auf mindestens -25°C heruntergekühlt wurden.

When frozen to at least -25°C, the solid sealing inserts are easy to drill.

### Kurzes Anschlussgewinde Pg | Short entry thread Pg



#### Progress MS NBR



Einteiliger Dichteinsatz ohne Bohrung  
 nicht durchgehend isolierend

One-piece solid sealing insert  
 not overall length insulated

G	> Ø < max mm		H mm	L mm	Art.-Nr.   Art. No.	
Pg 7	8.0	15	17	6.0	1000.07.30	50
Pg 9	10.5	18	22	6.0	1000.09.30	50
Pg 11	12.0	21	21	6.0	1000.11.30	50
Pg 11	15.0	24	23	6.0	1000.11.20.30	50
Pg 13	15.0	24	23	6.0	1000.13.30	50
Pg 16	15.0	24	23	6.0	1000.16.30	50
Pg 16	18.5	30	28	6.0	1000.16.25.30	25
Pg 21	20.5	30	28	7.5	1000.21.30	25
Pg 21	23.0	36	28	7.5	1000.21.32.30	25
Pg 29	27.5	38	28	8.0	1000.29.30	25
Pg 29	33.0	46	31	8.0	1000.29.40.30	25
Pg 36	35.0	50	32	8.0	1000.36.30	10
Pg 36	42.0	55	34	8.0	1000.36.50.30	10
Pg 42	42.0	55	34	10.0	1000.42.30	10
Pg 48	49.0	65	37	11.0	1000.48.30	10

Erhältlich mit Dichteinsatz gemäß EN 45545. Bei Anfragen oder Bestellung bitte ein F vor die Artikelnummer setzen.

Available with sealing inserts conformity with EN 45545. When placing an inquiry, prefix the article number by the capital F.

#### Technischer Hinweis

#### Technical note

Dichteinsätze ohne Bohrung lassen sich gut bearbeiten, wenn sie vorher auf mindestens -25°C heruntergekühlt wurden.

When frozen to at least -25°C, the solid sealing inserts are easy to drill.

# Kabelverschraubungen Progress® Messing mit Dichteinsatz ohne Bohrung

## Cable glands Progress® nickel-plated brass with sealing insert without drilled hole

### Kurzes Anschlussgewinde metrisch | Short entry thread metric

Material: Messing vernickelt  
 Dichtung: FPM, ohne Bohrung  
 O-Ring : FPM  
 Einsatztemperatur: -40°C / +200°C  
 Schutzart: IP 68 (bis 10 bar)  
 Weitere Schutzart: IP 69K

Material: Nickel-plated brass  
 Seal: FPM, without drilled hole  
 O-ring : FPM  
 Temperature range: -40°C / +200°C  
 Protection class: IP 68 (up to 10 bar)  
 Further protection: IP 69K

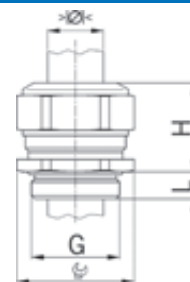

#### Progress MS FPM

Für hohe Temperaturen  
 Einteiliger Dichteinsatz ohne Bohrung  
 nicht durchgehend isolierend

For high temperature applications  
 One-piece solid sealing insert  
 not overall length insulated

G	>Ø< max mm	H mm	L mm	i info	Art.-Nr.   Art. No.		
M6x1.0	3.5	8	12	5	1	1000.06.30.91	50
M8x1.25	5.0	11	14	5	1	1000.08.30.91	50
M10x1.5	6.0	13	15	5	1	1000.10.30.91	50
M12x1.5	8.0	15	17	5	-	1000.12.30.91	50
M16x1.5	10.5	18	22	5	-	1000.17.30.91	50
M20x1.5	15.0	24	23	6	-	1000.20.30.91	50
M25x1.5	20.5	30	28	7	-	1000.25.30.91	25
M32x1.5	25.5	36	28	8	-	1000.32.30.91	25
M40x1.5	33.0	46	31	8	-	1000.40.30.91	10
M50x1.5	42.0	55	34	9	-	1000.50.30.91	10
M63x1.5	52.0	70	37	10	-	1000.63.30.91	5

1 = Metrisches Regelgewinde

1 = Metric coarse-pitch thread

#### Technischer Hinweis

Dichteinsätze ohne Bohrung lassen sich gut bearbeiten, wenn sie vorher auf mindestens -25°C heruntergekühlt wurden.

#### Technical note

When frozen to at least -25°C, the solid sealing inserts are easy to drill.



### Kurzes Anschlussgewinde Pg | Short entry thread Pg

#### Progress MS FPM

Für hohe Temperaturen  
 Einteiliger Dichteinsatz ohne Bohrung  
 nicht durchgehend isolierend

For high temperature applications  
 One-piece solid sealing insert  
 not overall length insulated

G	>Ø< max mm	H mm	L mm	Art.-Nr.   Art. No.		
Pg 7	8.0	15	17	6.0	1000.07.30.91	50
Pg 9	10.5	18	22	6.0	1000.09.30.91	50
Pg 11	12.0	21	21	6.0	1000.11.30.91	50
Pg 11	15.0	24	23	6.0	1000.11.20.30.91	50
Pg 13	15.0	24	23	6.0	1000.13.30.91	50
Pg 16	15.0	24	23	6.0	1000.16.30.91	50
Pg 16	18.5	30	28	6.0	1000.16.25.30.91	25
Pg 21	20.5	30	28	7.5	1000.21.30.91	25
Pg 21	23.0	36	28	7.5	1000.21.32.30.91	25
Pg 29	27.5	38	28	8.0	1000.29.30.91	25
Pg 29	33.0	46	31	8.0	1000.29.40.30.91	25
Pg 36	35.0	50	32	8.0	1000.36.30.91	10
Pg 36	42.0	55	34	8.0	1000.36.50.30.91	10
Pg 42	42.0	55	34	10.0	1000.42.30.91	10
Pg 48	49.0	65	37	11.0	1000.48.30.91	10

#### Technischer Hinweis

Dichteinsätze ohne Bohrung lassen sich gut bearbeiten, wenn sie vorher auf mindestens -25°C heruntergekühlt wurden.

#### Technical note

When frozen to at least -25°C, the solid sealing inserts are easy to drill.





# Kabelverschraubungen Progress® Messing für Flachkabel

## Cable glands Progress® nickel-plated brass for flat cables

Kurzes Anschlussgewinde metrisch | Short entry thread metric

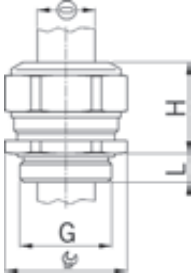

Material: Messing vernickelt  
 Dichtung: TPE  
 O-Ring : NBR  
 Zugentlastung: Ausführung A  
 Einsatztemperatur: -40°C / +100°C  
 Schutzart: IP 68

Material: Nickel-plated brass  
 Seal: TPE  
 O-ring : NBR  
 Strain relief: Version A  
 Temperature range: -40°C / +100°C  
 Protection class: IP 68



### Progress MS FK



Einteiliger Dichteinsatz  
 nicht durchgehend isolierend

One-piece sealing insert  
 not overall length insulated

G	Ø		mm	H mm	L mm	Art.-Nr.   Art. No.	☐
	min mm	max mm					
M16x1.5	7.3x2.5	9.0x4.2	18	22	5	1300.17.090.042	50
M20x1.5	10.5x2.5	13.0x5.0	24	23	6	1300.20.130.050	50
M20x1.5	12.5x2.5	15.0x5.0	24	23	6	1300.20.150.050	50
M25x1.5	16.0x4.0	19.0x7.0	30	28	7	1300.25.190.070	25
M32x1.5	19.0x3.0	22.0x6.0	36	28	8	1300.32.220.060	25
M32x1.5	19.0x5.0	22.0x8.0	36	28	8	1300.32.220.080	25
M40x1.5	23.0x4.0	26.0x7.0	46	31	8	1300.40.260.070	10
M40x1.5	23.5x6.0	26.5x9.0	46	31	8	1300.40.265.090	10
M40x1.5	25.0x3.0	28.0x6.0	46	31	8	1300.40.280.060	10
M40x1.5	27.0x7.0	30.0x10.0	46	31	8	1300.40.300.100	10
M40x1.5	29.0x6.0	32.0x9.0	46	31	8	1300.40.320.090	10
M40x1.5	30.0x3.5	33.0x6.5	46	31	8	1300.40.330.065	10
M50x1.5	31.0x8.5	34.0x11.5	55	34	9	1300.50.340.115	10
M50x1.5	34.0x4.0	37.0x7.0	55	34	9	1300.50.370.070	10
M50x1.5	36.5x2.5	40.0x6.0	55	34	9	1300.50.400.060	10
M50x1.5	36.5x10.0	40.0x13.5	55	34	9	1300.50.400.135	10
M50x1.5	38.5x10.5	42.0x14.0	55	34	9	1300.50.420.140	10
M63x1.5	42.0x10.0	46.0x14.0	70	37	10	1300.63.460.140	5
M63x1.5	42.5x2.0	46.5x6.0	70	37	10	1300.63.465.060	5

Erhältlich mit Dichteinsatz gemäß EN 45545. Bei Anfragen oder Bestellung bitte ein F vor die Artikelnummer setzen.

Available with sealing inserts conformity with EN 45545. When placing an inquiry, prefix the article number by the capital F.

# Kabelverschraubungen Progress® Messing für Flachkabel Cable glands Progress® nickel-plated brass for flat cables

Langes Anschlussgewinde metrisch | Long entry thread metric

Material: Messing vernickelt  
Dichtung: TPE  
O-Ring : NBR  
Zugentlastung: Ausführung A  
Einsatztemperatur: -40°C / +100°C  
Schutzart: IP 68

Material: Nickel-plated brass  
Seal: TPE  
O-ring : NBR  
Strain relief: Version A  
Temperature range: -40°C / +100°C  
Protection class: IP 68

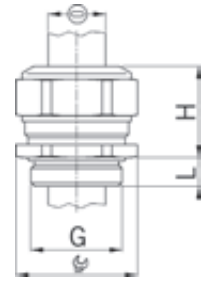

## Progress MS FK



Einteiliger Dichteinsatz  
nicht durchgehend isolierend

One-piece sealing insert  
not overall length insulated

G	min mm	max mm	mm	H mm	L mm	Art.-Nr.   Art. No.	
M16x1.5	7.3x2.5	9.0x4.2	18	22	10	1301.17.090.042	50
M20x1.5	10.5x2.5	13.0x5.0	24	23	10	1301.20.130.050	50
M20x1.5	12.5x2.5	15.0x5.0	24	23	10	1301.20.150.050	50
M25x1.5	16.0x4.0	19.0x7.0	30	28	11	1301.25.190.070	25
M32x1.5	19.0x3.0	22.0x6.0	36	28	13	1301.32.220.060	25
M32x1.5	19.0x5.0	22.0x8.0	36	28	13	1301.32.220.080	25
M40x1.5	23.0x4.0	26.0x7.0	46	31	13	1301.40.260.070	10
M40x1.5	23.5x6.0	26.5x9.0	46	31	13	1301.40.265.090	10
M40x1.5	25.0x3.0	28.0x6.0	46	31	13	1301.40.280.060	10
M40x1.5	27.0x7.0	30.0x10.0	46	31	13	1301.40.300.100	10
M40x1.5	29.0x6.0	32.0x9.0	46	31	13	1301.40.320.090	10
M40x1.5	30.0x3.5	33.0x6.5	46	31	13	1301.40.330.065	10
M50x1.5	31.0x8.5	34.0x11.5	55	34	14	1301.50.340.115	10
M50x1.5	34.0x4.0	37.0x7.0	55	34	14	1301.50.370.070	10
M50x1.5	36.5x2.5	40.0x6.0	55	34	14	1301.50.400.060	10
M50x1.5	36.5x10.0	40.0x13.5	55	34	14	1301.50.400.135	10
M50x1.5	38.5x10.5	42.0x14.0	55	34	14	1301.50.420.140	10
M63x1.5	42.0x10.0	46.0x14.0	70	37	14	1301.63.460.140	5
M63x1.5	42.5x2.0	46.5x6.0	70	37	14	1301.63.465.060	5



Erhältlich mit Dichteinsatz gemäß EN 45545. Bei Anfragen oder Bestellung bitte ein F vor die Artikelnummer setzen.

Available with sealing inserts conformity with EN 45545. When placing an inquiry, prefix the article number by the capital F.

# Kabelverschraubungen Progress® Messing für Flachkabel

## Cable glands Progress® nickel-plated brass for flat cables

### Kurzes Anschlussgewinde Pg | Short entry thread Pg

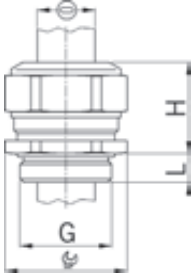

Material: Messing vernickelt  
 Dichtung: TPE  
 O-Ring : NBR  
 Einsatztemperatur: -40°C / +100°C  
 Schutzart: IP 68

Material: Nickel-plated brass  
 Seal: TPE  
 O-ring : NBR  
 Temperature range: -40°C / +100°C  
 Protection class: IP 68



#### Progress MS FK

Einteiliger Dichteinsatz  
 nicht durchgehend isolierend

One-piece sealing insert  
 not overall length insulated

G	min mm	max mm	mm	H mm	L mm	Art.-Nr.   Art. No.	
Pg 9	7.3x2.5	9.0x4.2	18	22	6.0	1300.09.090.042	50
Pg 13	10.5x2.5	13.0x5.0	24	23	6.0	1300.13.130.050	50
Pg 13	12.5x2.5	15.0x5.0	24	23	6.0	1300.13.150.050	50
Pg 16	10.5x2.5	13.0x5.0	24	23	6.0	1300.16.130.050	50
Pg 16	12.5x2.5	15.0x5.0	24	23	6.0	1300.16.150.050	50
Pg 21	16.0x4.0	19.0x7.0	30	28	7.5	1300.21.190.070	25
Pg 21	19.0x3.0	22.0x6.0	36	28	7.5	1300.21.220.060	25
Pg 21	19.0x5.0	22.0x8.0	36	28	7.5	1300.21.220.080	25
Pg 29	23.0x4.0	26.0x7.0	46	31	8.0	1300.29.260.070	25
Pg 29	23.5x6.0	26.5x9.0	46	31	8.0	1300.29.265.090	25
Pg 29	25.0x3.0	28.0x6.0	46	31	8.0	1300.29.280.060	25
Pg 29	27.0x7.0	30.0x10.0	46	31	8.0	1300.29.300.100	25
Pg 29	29.0x6.0	32.0x9.0	46	31	8.0	1300.29.320.090	25
Pg 29	30.0x3.5	33.0x6.5	46	31	8.0	1300.29.330.065	25
Pg 42	31.0x8.5	34.0x11.5	55	34	10.0	1300.42.340.115	10
Pg 42	34.0x4.0	37.0x7.0	55	34	10.0	1300.42.370.070	10
Pg 42	36.5x2.5	40.0x6.0	55	34	10.0	1300.42.400.060	10
Pg 42	36.5x10.0	40.0x13.5	55	34	10.0	1300.42.400.135	10
Pg 42	38.5x10.5	42.0x14.0	55	34	10.0	1300.42.420.140	10
Pg 48	42.0x10.0	46.0x14.0	65	37	11.0	1300.48.460.140	10
Pg 48	42.5x2.0	46.5x6.0	65	37	11.0	1300.48.465.060	10

### Langes Anschlussgewinde Pg | Long entry thread Pg



#### Progress MS FK

Einteiliger Dichteinsatz  
 nicht durchgehend isolierend

One-piece sealing insert  
 not overall length insulated

G	min mm	max mm	mm	H mm	L mm	Art.-Nr.   Art. No.	
Pg 9	7.3x2.5	9.0x4.2	18	22	10	1301.09.090.042	50
Pg 13	10.5x2.5	13.0x5.0	24	23	10	1301.13.130.050	50
Pg 13	12.5x2.5	15.0x5.0	24	23	10	1301.13.150.050	50
Pg 16	10.5x2.5	13.0x5.0	24	23	10	1301.16.130.050	50
Pg 16	12.5x2.5	15.0x5.0	24	23	10	1301.16.150.050	50
Pg 21	16.0x4.0	19.0x7.0	30	28	12	1301.21.190.070	25
Pg 21	19.0x3.0	22.0x6.0	36	28	12	1301.21.220.060	25
Pg 21	19.0x5.0	22.0x8.0	36	28	12	1301.21.220.080	25
Pg 29	23.0x4.0	26.0x7.0	46	31	12	1301.29.260.070	25
Pg 29	23.5x6.0	26.5x9.0	46	31	12	1301.29.265.090	25
Pg 29	25.0x3.0	28.0x6.0	46	31	12	1301.29.280.060	25
Pg 29	27.0x7.0	30.0x10.0	46	31	12	1301.29.300.100	25
Pg 29	29.0x6.0	32.0x9.0	46	31	12	1301.29.320.090	25
Pg 29	30.0x3.5	33.0x6.5	46	31	12	1301.29.330.065	25
Pg 42	31.0x8.5	34.0x11.5	55	34	15	1301.42.340.115	10
Pg 42	34.0x4.0	37.0x7.0	55	34	15	1301.42.370.070	10
Pg 42	36.5x2.5	40.0x6.0	55	34	15	1301.42.400.060	10
Pg 42	36.5x10.0	40.0x13.5	55	34	15	1301.42.400.135	10
Pg 42	38.5x10.5	42.0x14.0	55	34	15	1301.42.420.140	10
Pg 48	42.0x10.0	46.0x14.0	65	37	15	1301.48.460.140	10
Pg 48	42.5x2.0	46.5x6.0	65	37	15	1301.48.465.060	10

# Kabelverschraubungen Progress® Messing mit speziellem Anschlussgewinde

## Cable glands Progress® nickel-plated brass with special entry thread

### Speziell langes Anschlussgewinde metrisch | Extra-long entry thread metric

Material: Messing vernickelt  
 Dichtung: TPE  
 O-Ring : NBR  
 Zugentlastung: Ausführung A  
 Einsatztemperatur: -40°C / +100°C  
 Schutzart: IP 68 (bis 10 bar)  
 Weitere Schutzart: IP 69K

Material: Nickel-plated brass  
 Seal: TPE  
 O-ring : NBR  
 Strain relief: Version A  
 Temperature range: -40°C / +100°C  
 Protection class: IP 68 (up to 10 bar)  
 Further protection: IP 69K

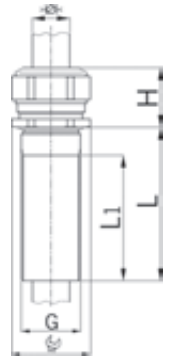



#### Progress MS L



Anschlussgewinde metrisch 50 mm lang  
 Zweiteiliger Dichteinsatz  
 nicht durchgehend isolierend

Entry thread metric, 50 mm long  
 Two-piece sealing insert  
 not overall length insulated

G	> Ø < min mm	> Ø < max mm	 mm	H mm	L1 mm	L mm	Art.-Nr.   Art. No.	
M16x1.5	6.0	10.5	24/18	22	40	50	1100.17.50	10
M20x1.5	8.0	15.0	30/24	23	40	50	1100.20.50	10
M25x1.5	12.5	20.5	36/30	28	40	50	1100.25.50	10
M32x1.5	17.0	25.5	46/36	28	40	50	1100.32.50	10
M40x1.5	24.0	33.0	55/46	31	40	50	1100.40.50	10

Weitere Abmessungen auf Anfrage

Further dimensions upon request



### Speziell langes Anschlussgewinde Pg | Specially long entry thread Pg

Material: Messing vernickelt  
 Dichtung: TPE  
 O-Ring : NBR  
 Einsatztemperatur: -40°C / +100°C  
 Schutzart: IP 68 (bis 10 bar)  
 Weitere Schutzart: IP 69K

Material: Nickel-plated brass  
 Seal: TPE  
 O-ring : NBR  
 Temperature range: -40°C / +100°C  
 Protection class: IP 68 (up to 10 bar)  
 Further protection: IP 69K

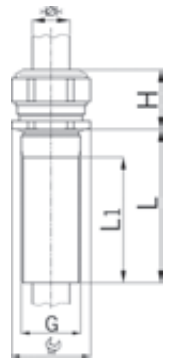

#### Progress MS L



Anschlussgewinde Pg 50 mm lang  
 Zweiteiliger Dichteinsatz  
 nicht durchgehend isolierend

Entry thread Pg, 50 mm long  
 Two-piece sealing insert  
 not overall length insulated

G	> Ø < min mm	> Ø < max mm	 mm	H mm	L1 mm	L mm	Art.-Nr.   Art. No.	
Pg 11	5.5	12.0	27/21	21	40	50	1100.11.50	10
Pg 13	8.0	15.0	30/24	23	40	50	1100.13.50	10
Pg 16	8.0	15.0	30/24	23	40	50	1100.16.50	10
Pg 21	12.5	20.5	38/30	28	40	50	1100.21.50	10
Pg 29	19.0	27.5	46/38	28	40	50	1100.29.50	10

Weitere Abmessungen auf Anfrage

Further dimensions upon request



# Kabelverschraubungen Progress® Messing mit speziellem Anschlussgewinde

## Cable glands Progress® nickel-plated brass with special entry thread

### Mit Innengewinde metrisch | With inner thread metric

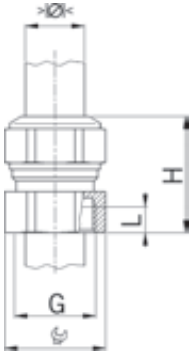

Material: Messing vernickelt  
 Dichtung: TPE  
 Zugentlastung: Ausführung A  
 Einsatztemperatur: -40°C / +100°C  
 Schutzart: IP 68, wenn Anschlussgewinde abgedichtet  
 Weitere Schutzart: IP 69K

Material: Nickel-plated brass  
 Seal: TPE  
 Strain relief: Version A  
 Temperature range: -40°C / +100°C  
 Protection class: IP 68, if the entry thread is sealed  
 Further protection: IP 69K



#### Progress MS IG



Anschluss mit Innengewinde metrisch  
 Zweiteiliger Dichteinsatz  
 nicht durchgehend isolierend

Internal thread metric  
 Two-piece sealing insert  
 not overall length insulated

G	> Ø < min mm	> Ø < max mm	 mm	H mm	L mm	Art.-Nr.   Art. No.	
M16x1.5	6.0	10.5	18	28	6	1400.17	25
M20x1.5	8.0	15.0	24	31	6	1400.20	25
M25x1.5	12.5	20.5	30	40	10	1400.25	25

Erhältlich mit Dichteinsatz gemäß EN 45545. Bei Anfragen oder Bestellung bitte ein F vor die Artikelnummer setzen.

Available with sealing inserts conformity with EN 45545. When placing an inquiry, prefix the article number by the capital F.

### Mit Innengewinde Pg | With inner thread Pg

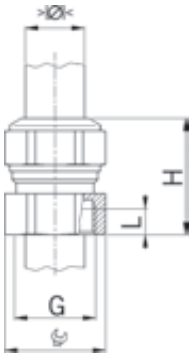

Material: Messing vernickelt  
 Dichtung: TPE  
 Einsatztemperatur: -40°C / +100°C  
 Schutzart: IP 68, wenn Anschlussgewinde abgedichtet  
 Weitere Schutzart: IP 69K

Material: Nickel-plated brass  
 Seal: TPE  
 Temperature range: -40°C / +100°C  
 Protection class: IP 68, if the entry thread is sealed  
 Further protection: IP 69K



#### Progress MS IG



Anschluss mit Innengewinde Pg  
 Zweiteiliger Dichteinsatz  
 nicht durchgehend isolierend

Internal thread Pg  
 Two-piece sealing insert  
 not overall length insulated

G	> Ø < min mm	> Ø < max mm	 mm	H mm	L mm	Art.-Nr.   Art. No.	
Pg 11	5.5	12.0	21	28	6	1400.11	25
Pg 16	8.0	15.0	24	31	6	1400.16	25
Pg 21	12.5	20.5	30	40	10	1400.21	25

Erhältlich mit Dichteinsatz gemäß EN 45545. Bei Anfragen oder Bestellung bitte ein F vor die Artikelnummer setzen.

Available with sealing inserts conformity with EN 45545. When placing an inquiry, prefix the article number by the capital F.



# Kabelverschraubungen Progress® Messing mit Knickschutzfeder Cable glands Progress® nickel-plated brass with antikink spring

## Kurzes Anschlussgewinde metrisch | Short entry thread metric

### Kabelverschraubungen Progress® Messing mit Knickschutztülle EPDM

Material:	Messing vernickelt
Dichtung:	NBR
O-Ring :	NBR
Knickschutztülle:	EPDM
Zugentlastung:	Ausführung A
Einsatztemperatur:	-40°C / +100°C
Schutzart:	IP 68
Weitere Schutzart:	IP 69K

### Cable glands Progress® nickel-plated brass with antikink nozzle EPDM

Material:	Nickel-plated brass
Seal:	NBR
O-ring :	NBR
antikink nozzle:	EPDM
Strain relief:	Version A
Temperature range:	-40°C / +100°C
Protection class:	IP 68
Further protection:	IP 69K

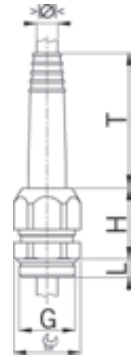

Einteiliger Dichteinsatz  
nicht durchgehend isolierend

One-piece sealing insert  
not overall length insulated

G	> Ø < min mm	> Ø < max mm		H mm	T mm	L mm	i info	Art.-Nr.   Art. No.	
M8x1.25	3.8	4.8	11	12	25	6	1	1008.52	50
M10x1.5	4.0	6.0	16	20	35	6	1	1010.52	50
M12x1.5	4.0	6.0	16	20	35	6	-	1012.52	50
M16x1.5	6.0	8.8	20	24	45	6	-	1017.52	50
M20x1.5	9.0	11.0	24	28	65	6	-	1020.51	25
M20x1.5	10.5	13.0	24	28	73	6	-	1020.52	25
M25x1.5	13.0	16.5	32	33	92	7	-	1025.52	10

1 = Metrisches Regelgewinde

1 = Metric coarse-pitch thread



## Kurzes Anschlussgewinde Pg | Short entry thread Pg

### Kabelverschraubungen Progress® Messing mit Knickschutztülle EPDM

Material:	Messing vernickelt
Dichtung:	NBR
O-Ring :	NBR
Knickschutztülle:	EPDM
Einsatztemperatur:	-40°C / +100°C
Schutzart:	IP 68
Weitere Schutzart:	IP 69K

### Cable glands Progress® nickel-plated brass with antikink nozzle EPDM

Material:	Nickel-plated brass
Seal:	NBR
O-ring :	NBR
antikink nozzle:	EPDM
Temperature range:	-40°C / +100°C
Protection class:	IP 68
Further protection:	IP 69K

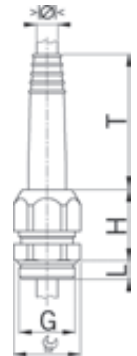

Einteiliger Dichteinsatz  
nicht durchgehend isolierend

One-piece sealing insert  
not overall length insulated

G	> Ø < min mm	> Ø < max mm		H mm	T mm	L mm	Art.-Nr.   Art. No.	
Pg 7	4.0	6.0	16	20	35	6	1007.52	50
Pg 9	6.0	8.8	20	24	45	6	1009.52	50
Pg 11	6.0	8.8	20	24	45	6	1011.52	50
Pg 13	9.0	11.0	24	28	65	6	1013.51	25
Pg 13	10.5	13.0	24	28	73	6	1013.52	25
Pg 16	9.0	11.0	24	28	65	6	1016.51	25
Pg 16	10.5	13.0	24	28	73	6	1016.52	25
Pg 21	13.0	16.5	32	33	92	7.5	1021.51	10



# Kabelverschraubungen Progress® Messing mit Knickschutzfeder

## Cable glands Progress® nickel-plated brass with antikink spring

### Kurzes Anschlussgewinde metrisch | Short entry thread metric

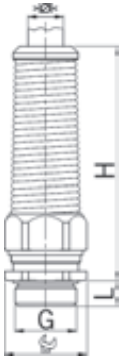

Material: Messing vernickelt  
 Knickschutzfeder: Rostfreier Stahl A2  
 Dichtung: TPE  
 O-Ring : NBR  
 Zugentlastung: Ausführung A  
 Einsatztemperatur: -40°C / +100°C  
 Schutzart: IP 68 (bis 10 bar)  
 Weitere Schutzart: IP 69K

Material: Nickel-plated brass  
 Antikink spring: Stainless steel A2  
 Seal: TPE  
 O-ring : NBR  
 Strain relief: Version A  
 Temperature range: -40°C / +100°C  
 Protection class: IP 68 (up to 10 bar)  
 Further protection: IP 69K



#### Progress MS FKN

Einteiliger Dichteinsatz  
 durchgehend isolierend

One-piece sealing insert  
 overall length insulated



G	> Ø < min mm	> Ø < max mm		H mm	L mm	i info	Art.-Nr.   Art. No.	
M8x1.25	2.5	3.0	11	49	5	1	1060.08.52.030	10
M8x1.25	3.5	4.0	11	49	5	1	1060.08.52.040	10
M10x1.5	3.0	4.0	13	52	5	1	1060.10.52.040	10
M10x1.5	4.0	6.0	13	52	5	1	1060.10.52.060	10
M12x1.5	3.5	5.0	15	57	5	-	1060.12.52.050	10
M12x1.5	5.0	6.5	15	57	5	-	1060.12.52.065	10
M12x1.5	6.5	7.5	15	57	5	-	1060.12.52.075	10
M16x1.5	4.5	6.0	18	66	5	-	1060.17.52.060	10
M16x1.5	6.0	8.0	18	66	5	-	1060.17.52.080	10
M16x1.5	8.0	10.5	18	66	5	-	1060.17.52.105	10
M20x1.5	6.0	8.0	24	86	6	-	1060.20.52.080	10
M20x1.5	8.0	11.0	24	86	6	-	1060.20.52.110	10
M20x1.5	11.0	14.5	24	86	6	-	1060.20.52.145	10
M25x1.5	9.5	12.5	30	99	7	-	1060.25.52.125	10
M25x1.5	12.5	16.0	30	99	7	-	1060.25.52.160	10
M25x1.5	16.0	19.0	30	99	7	-	1060.25.52.190	10
M32x1.5	17.0	21.0	36	109	8	-	1060.32.52.210	5
M32x1.5	21.0	24.5	36	109	8	-	1060.32.52.245	5

1 = Metrisches Regelgewinde

1 = Metric coarse-pitch thread

Erhältlich mit Dichteinsatz gemäß EN 45545. Bei Anfragen oder Bestellung bitte ein F vor die Artikelnummer setzen.

Available with sealing inserts conformity with EN 45545. When placing an inquiry, prefix the article number by the capital F.

#### Auf Anfrage lieferbar:

- Kurzes Anschlussgewinde mit kurzem ein- oder zweiteiligem Dichteinsatz.
- Langes Anschlussgewinde mit kurzem oder durchgehend isolierendem ein- oder zweiteiligem Dichteinsatz.

#### Available on request:

- Short entry thread with short one-piece or two-piece sealing insert.
- Long entry thread with short or full-length insulating one-piece or two-piece sealing insert.

#### Progress MS FKN

Zweiteiliger Dichteinsatz  
 durchgehend isolierend

Two-piece sealing insert  
 overall length insulated



G	> Ø < min mm	> Ø < max mm		H mm	L mm	Art.-Nr.   Art. No.	
M16x1.5	6.0	10.5	18	66	5	1060.17.52	10
M20x1.5	8.0	14.5	24	86	6	1060.20.52	10
M25x1.5	12.5	19.0	30	99	7	1060.25.52	10
M32x1.5	17.0	24.5	36	109	8	1060.32.52	5

Erhältlich mit Dichteinsatz gemäß EN 45545. Bei Anfragen oder Bestellung bitte ein F vor die Artikelnummer setzen.

Available with sealing inserts conformity with EN 45545. When placing an inquiry, prefix the article number by the capital F.

#### Auf Anfrage lieferbar:

- Kurzes Anschlussgewinde mit kurzem ein- oder zweiteiligem Dichteinsatz.
- Langes Anschlussgewinde mit kurzem oder durchgehend isolierendem ein- oder zweiteiligem Dichteinsatz.

#### Available on request:

- Short entry thread with short one-piece or two-piece sealing insert.
- Long entry thread with short or full-length insulating one-piece or two-piece sealing insert.

# Kabelverschraubungen Progress® Messing mit Knickschutzfeder Cable glands Progress® nickel-plated brass with antikink spring

## Kurzes Anschlussgewinde Pg | Short entry thread Pg

Material: Messing vernickelt  
Knickschutzfeder: Rostfreier Stahl A2  
Dichtung: TPE  
O-Ring : NBR  
Einsatztemperatur: -40°C / +100°C  
Schutzart: IP 68 (bis 10 bar)  
Weitere Schutzart: IP 69K

Material: Nickel-plated brass  
Antikink spring: Stainless steel A2  
Seal: TPE  
O-ring : NBR  
Temperature range: -40°C / +100°C  
Protection class: IP 68 (up to 10 bar)  
Further protection: IP 69K

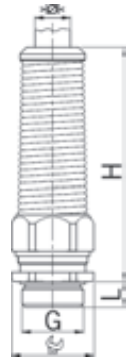

### Progress MS FKN



Einteiliger Dichteinsatz  
durchgehend isolierend

One-piece sealing insert  
overall length insulated

G	$\gt;\varnothing<$ min mm	$\gt;\varnothing<$ max mm		H mm	L mm	Art.-Nr.   Art. No.	
Pg 7	3.5	5.0	15	57	6	1060.07.52.050	10
Pg 7	5.0	6.5	15	57	6	1060.07.52.065	10
Pg 7	6.5	7.5	15	57	6	1060.07.52.075	10
Pg 9	4.5	6.0	18	66	6	1060.09.52.060	10
Pg 9	6.0	8.0	18	66	6	1060.09.52.080	10
Pg 9	8.0	10.5	18	66	6	1060.09.52.105	10
Pg 11	4.5	6.0	18/21	66	6	1060.11.52.060	10
Pg 11	6.0	8.0	18/21	66	6	1060.11.52.080	10
Pg 11	8.0	10.5	18/21	66	6	1060.11.52.105	10
Pg 13	6.0	8.0	24	86	6	1060.13.52.080	10
Pg 13	8.0	11.0	24	86	6	1060.13.52.110	10
Pg 13	11.0	14.5	24	86	6	1060.13.52.145	10
Pg 16	6.0	8.0	24	86	6	1060.16.52.080	10
Pg 16	8.0	11.0	24	86	6	1060.16.52.110	10
Pg 16	11.0	14.5	24	86	6	1060.16.52.145	10
Pg 21	9.5	12.5	30	99	7.5	1060.21.52.125	5
Pg 21	12.5	16.0	30	99	7.5	1060.21.52.160	5
Pg 21	16.0	19.0	30	99	7.5	1060.21.52.190	5



Erhältlich mit Dichteinsatz gemäß EN 45545. Bei Anfragen oder Bestellung bitte ein F vor die Artikelnummer setzen.

Available with sealing inserts conformity with EN 45545. When placing an inquiry, prefix the article number by the capital F.

#### Auf Anfrage lieferbar:

- Kurzes Anschlussgewinde mit kurzem ein- oder zweiteiligem Dichteinsatz.
- Langes Anschlussgewinde mit kurzem oder durchgehend isolierendem ein- oder zweiteiligem Dichteinsatz.

#### Available on request:

- Short entry thread with short one-piece or two-piece sealing insert.
- Long entry thread with short or full-length insulating one-piece or two-piece sealing insert.

### Progress MS FKN



Zweiteiliger Dichteinsatz  
durchgehend isolierend

Two-piece sealing insert  
overall length insulated

G	$\gt;\varnothing<$ min mm	$\gt;\varnothing<$ max mm		H mm	L mm	Art.-Nr.   Art. No.	
Pg 9	6.0	10.5	18	66	6	1060.09.52	10
Pg 11	6.0	10.5	18/21	66	6	1060.11.52	10
Pg 13	8.0	14.5	24	86	6	1060.13.52	10
Pg 16	8.0	14.5	24	86	6	1060.16.52	10
Pg 21	12.5	19.0	30	99	7.5	1060.21.52	5



Erhältlich mit Dichteinsatz gemäß EN 45545. Bei Anfragen oder Bestellung bitte ein F vor die Artikelnummer setzen.

Available with sealing inserts conformity with EN 45545. When placing an inquiry, prefix the article number by the capital F.

#### Auf Anfrage lieferbar:

- Kurzes Anschlussgewinde mit kurzem ein- oder zweiteiligem Dichteinsatz.
- Langes Anschlussgewinde mit kurzem oder durchgehend isolierendem ein- oder zweiteiligem Dichteinsatz.

#### Available on request:

- Short entry thread with short one-piece or two-piece sealing insert.
- Long entry thread with short or full-length insulating one-piece or two-piece sealing insert.

# Kabelverschraubungen Progress® Messing mit Klemmbacken

## Cable glands Progress® nickel-plated brass with clamps

### Kurzes Anschlussgewinde metrisch | Short entry thread metric

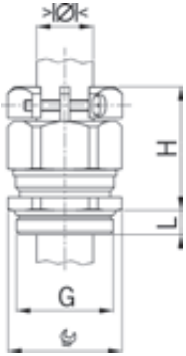

Material: Messing vernickelt  
 Klemmschrauben: Rostfreier Stahl A2  
 Dichtung: TPE  
 O-Ring : NBR  
 Zugentlastung: Ausführung B  
 Einsatztemperatur: -40°C / +100°C  
 Schutzart: IP 68 (bis 10 bar)  
 Weitere Schutzart: IP 69K

Material: Nickel-plated brass  
 Screws: Stainless steel A2  
 Seal: TPE  
 O-ring : NBR  
 Strain relief: Version B  
 Temperature range: -40°C / +100°C  
 Protection class: IP 68 (up to 10 bar)  
 Further protection: IP 69K

#### Progress MS KB



Einteiliger Dichteinsatz  
 nicht durchgehend isolierend

One-piece sealing insert  
 not overall length insulated

G	>Ø< min mm	>Ø< max mm		H mm	L mm	i info	Art.-Nr.   Art. No.	
M10x1.5	3.0	4.0	13/16	24	5	1	1800.10.03.040	50
M10x1.5	4.0	6.0	13/16	24	5	1	1800.10.03.060	50
M12x1.5	5.0	6.5	15/16	26	5	-	1800.12.03.065	50
M12x1.5	6.5	8.0	15/16	26	5	-	1800.12.03.080	50

1 = Metrisches Regelgewinde

1 = Metric coarse-pitch thread

Erhältlich mit Dichteinsatz gemäß EN 45545. Bei Anfragen oder Bestellung bitte ein F vor die Artikelnummer setzen.

Available with sealing inserts conformity with EN 45545. When placing an inquiry, prefix the article number by the capital F.

#### Progress MS KB



Zweiteiliger Dichteinsatz  
 nicht durchgehend isolierend

Two-piece sealing insert  
 not overall length insulated

G	>Ø< min mm	>Ø< max mm		H mm	L mm	Art.-Nr.   Art. No.	
M16x1.5	6.0	10.5	18/19	30	5	1800.17.03.105	50
M20x1.5	8.0	15.0	24	31	6	1800.20.03.150	50
M25x1.5	12.5	20.5	30	35	7	1800.25.03.205	25
M32x1.5	17.0	25.5	36	40	8	1800.32.03.255	25
M40x1.5	24.0	33.0	46	44	8	1800.40.03.330	10
M50x1.5	33.0	42.0	55	49	9	1800.50.03.410	10
M63x1.5	40.0	52.0	70	55	10	1800.63.03.520	5
M75x1.5	50.0	63.0	80	56	11	1800.75.03.630	1

Erhältlich mit Dichteinsatz gemäß EN 45545. Bei Anfragen oder Bestellung bitte ein F vor die Artikelnummer setzen.

Available with sealing inserts conformity with EN 45545. When placing an inquiry, prefix the article number by the capital F.

# Kabelverschraubungen Progress® Messing mit Klemmbacken

## Cable glands Progress® nickel-plated brass with clamps

Langes Anschlussgewinde metrisch | Long entry thread metric

Material: Messing vernickelt  
 Klemmschrauben: Rostfreier Stahl A2  
 Dichtung: TPE  
 O-Ring : NBR  
 Zugentlastung: Ausführung B  
 Einsatztemperatur: -40°C / +100°C  
 Schutzart: IP 68 (bis 10 bar)  
 Weitere Schutzart: IP 69K

Material: Nickel-plated brass  
 Screws: Stainless steel A2  
 Seal: TPE  
 O-ring : NBR  
 Strain relief: Version B  
 Temperature range: -40°C / +100°C  
 Protection class: IP 68 (up to 10 bar)  
 Further protection: IP 69K

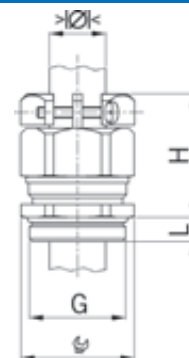

### Progress MS KB



Einteiliger Dichteinsatz  
 nicht durchgehend isolierend

One-piece sealing insert  
 not overall length insulated

G	>Ø< min mm	>Ø< max mm	PG	H mm	L mm	i info	Art.-Nr.   Art. No.	
M10x1.5	3.0	4.0	13/16	24	10	1	1800.10.13.040	50
M10x1.5	4.0	6.0	13/16	24	10	1	1800.10.13.060	50
M12x1.5	5.0	6.5	15/16	26	10	-	1800.12.13.065	50
M12x1.5	6.5	8.0	15/16	26	10	-	1800.12.13.080	50

1 = Metrisches Regelgewinde

1 = Metric coarse-pitch thread

Erhältlich mit Dichteinsatz gemäß EN 45545. Bei Anfragen oder Bestellung bitte ein F vor die Artikelnummer setzen.

Available with sealing inserts conformity with EN 45545. When placing an inquiry, prefix the article number by the capital F.



### Progress MS KB



Zweiteiliger Dichteinsatz  
 nicht durchgehend isolierend

Two-piece sealing insert  
 not overall length insulated

G	>Ø< min mm	>Ø< max mm	PG	H mm	L mm	Art.-Nr.   Art. No.	
M16x1.5	6.0	10.5	18/19	30	10	1800.17.13.105	50
M20x1.5	8.0	15.0	24	31	10	1800.20.13.150	50
M25x1.5	12.5	20.5	30	35	11	1800.25.13.205	25
M32x1.5	17.0	25.5	36	40	13	1800.32.13.255	25
M40x1.5	24.0	33.0	46	44	13	1800.40.13.330	10
M50x1.5	33.0	42.0	55	49	14	1800.50.13.410	10
M63x1.5	40.0	52.0	70	55	14	1800.63.13.520	5
M75x1.5	50.0	63.0	80	56	15	1800.75.13.630	1

Erhältlich mit Dichteinsatz gemäß EN 45545. Bei Anfragen oder Bestellung bitte ein F vor die Artikelnummer setzen.

Available with sealing inserts conformity with EN 45545. When placing an inquiry, prefix the article number by the capital F.





# Kabelverschraubungen Progress® Messing mit Klemmbacken

## Cable glands Progress® nickel-plated brass with clamps

### Kurzes Anschlussgewinde Pg | Short entry thread Pg

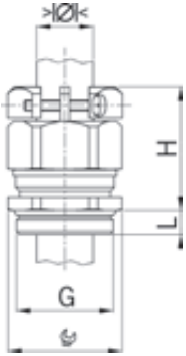

Material: Messing vernickelt  
 Klemmschrauben: Rostfreier Stahl A2  
 Dichtung: TPE  
 O-Ring : NBR  
 Einsatztemperatur: -40°C / +100°C  
 Schutzart: IP 68 (bis 10 bar)  
 Weitere Schutzart: IP 69K

Material: Nickel-plated brass  
 Screws: Stainless steel A2  
 Seal: TPE  
 O-ring : NBR  
 Temperature range: -40°C / +100°C  
 Protection class: IP 68 (up to 10 bar)  
 Further protection: IP 69K



#### Progress MS KB



Einteiliger Dichteinsatz  
 nicht durchgehend isolierend

One-piece sealing insert  
 not overall length insulated

G	>Ø< min mm	>Ø< max mm	 mm	H mm	L mm	Art.-Nr.   Art. No.	
Pg 7	5.0	6.5	15/16	26	6	<b>1800.07.03.065</b>	50
Pg 7	6.5	8.0	15/16	26	6	<b>1800.07.03.080</b>	50

Erhältlich mit Dichteinsatz gemäß EN 45545. Bei Anfragen oder Bestellung bitte ein F vor die Artikelnummer setzen.

Available with sealing inserts conformity with EN 45545. When placing an inquiry, prefix the article number by the capital F.



#### Progress MS KB



Zweiteiliger Dichteinsatz  
 nicht durchgehend isolierend

Two-piece sealing insert  
 not overall length insulated

G	>Ø< min mm	>Ø< max mm	 mm	H mm	L mm	Art.-Nr.   Art. No.	
Pg 9	6.0	10.5	18/19	30	6	<b>1800.09.03.105</b>	50
Pg 11	5.5	12.0	21	31	6	<b>1800.11.03.120</b>	50
Pg 13	8.0	15.0	24	31	6	<b>1800.13.03.150</b>	50
Pg 16	8.0	15.0	24	31	6	<b>1800.16.03.150</b>	50
Pg 21	12.5	20.5	30	35	7	<b>1800.21.03.205</b>	25
Pg 29	19.0	27.5	38	40	8	<b>1800.29.03.275</b>	25
Pg 36	26.0	35.0	50	47	8	<b>1800.36.03.350</b>	10
Pg 42	33.0	42.0	55	49	10	<b>1800.42.03.410</b>	10
Pg 48	37.0	49.0	65	51	11	<b>1800.48.03.490</b>	5

Erhältlich mit Dichteinsatz gemäß EN 45545. Bei Anfragen oder Bestellung bitte ein F vor die Artikelnummer setzen.

Available with sealing inserts conformity with EN 45545. When placing an inquiry, prefix the article number by the capital F.

# Kabelverschraubungen Progress® Messing mit Klemmbacken

## Cable glands Progress® nickel-plated brass with clamps

Langes Anschlussgewinde Pg | Long entry thread Pg

Material: Messing vernickelt  
 Klemmschrauben: Rostfreier Stahl A2  
 Dichtung: TPE  
 O-Ring : NBR  
 Einsatztemperatur: -40°C / +100°C  
 Schutzart: IP 68 (bis 10 bar)  
 Weitere Schutzart: IP 69K

Material: Nickel-plated brass  
 Screws: Stainless steel A2  
 Seal: TPE  
 O-ring : NBR  
 Temperature range: -40°C / +100°C  
 Protection class: IP 68 (up to 10 bar)  
 Further protection: IP 69K

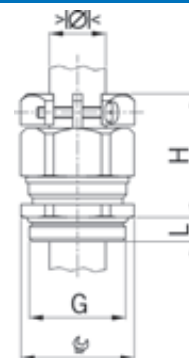



### Progress MS KB



Einteiliger Dichteinsatz  
 nicht durchgehend isolierend

One-piece sealing insert  
 not overall length insulated

G	>Ø< min mm	>Ø< max mm	 mm	H mm	L mm	Art.-Nr.   Art. No.	
Pg 7	5.0	6.5	15/16	26	10	1800.07.13.065	50
Pg 7	6.5	8.0	15/16	26	10	1800.07.13.080	50

Erhältlich mit Dichteinsatz gemäß EN 45545. Bei Anfragen oder Bestellung bitte ein F vor die Artikelnummer setzen.

Available with sealing inserts conformity with EN 45545. When placing an inquiry, prefix the article number by the capital F.





### Progress MS KB



Zweiteiliger Dichteinsatz  
 nicht durchgehend isolierend

Two-piece sealing insert  
 not overall length insulated

G	>Ø< min mm	>Ø< max mm	 mm	H mm	L mm	Art.-Nr.   Art. No.	
Pg 9	6.0	10.5	18/19	30	10	1800.09.13.105	50
Pg 11	5.5	12.0	21	31	10	1800.11.13.120	50
Pg 13	8.0	15.0	24	31	10	1800.13.13.150	50
Pg 16	8.0	15.0	24	31	10	1800.16.13.150	50
Pg 21	12.5	20.5	30	35	12	1800.21.13.205	25
Pg 29	19.0	27.5	38	40	12	1800.29.13.275	25
Pg 36	26.0	35.0	50	47	15	1800.36.13.350	10
Pg 42	33.0	42.0	55	49	15	1800.42.13.410	10
Pg 48	37.0	49.0	65	51	15	1800.48.13.490	5

Erhältlich mit Dichteinsatz gemäß EN 45545. Bei Anfragen oder Bestellung bitte ein F vor die Artikelnummer setzen.

Available with sealing inserts conformity with EN 45545. When placing an inquiry, prefix the article number by the capital F.



# Kabelverschraubungen Progress® Messing mit Klemmbacken

## Cable glands Progress® nickel-plated brass with clamps

Anschlussgewinde metrisch | Entry thread metric

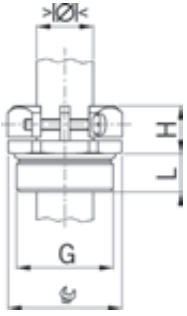

Material: Messing vernickelt  
 Klemmschrauben: Rostfreier Stahl A2  
 Zugentlastung: Ausführung B  
 Einsatztemperatur: -50°C / +300°C  
 Schutzart: IP 20

Material: Nickel-plated brass  
 Screws: Stainless steel A2  
 Strain relief: Version B  
 Temperature range: -50°C / +300°C  
 Protection class: IP 20





### Progress MS KBST



Mechanische Zugentlastung B

Mechanical strain relief B

G	> Ø < min mm	> Ø < max mm		H mm	L mm	Art.-Nr.   Art. No.	
M12x1.5	5.0	8.0	16	10	10	1812.02	50
M16x1.5	6.0	10.5	19	11	10	1817.02	50
M20x1.5	8.0	15.0	24	12	10	1820.02	50
M25x1.5	12.5	20.5	30	13	11	1825.02	25
M32x1.5	17.0	25.5	36	15	13	1832.02	25
M40x1.5	24.0	33.0	46	17	13	1840.02	10

# Kabelverschraubungen Progress® Messing mit Klemmbacken

## Cable glands Progress® nickel-plated brass with clamps



Anschlussgewinde Pg | Entry thread Pg

Material: Messing vernickelt  
 Klemmschrauben: Rostfreier Stahl A2  
 Einsatztemperatur: -50°C / +300°C  
 Schutzart: IP 20

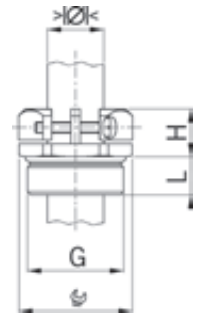
Material: Nickel-plated brass  
 Screws: Stainless steel A2  
 Temperature range: -50°C / +300°C  
 Protection class: IP 20



### Progress MS KBST

Mechanische Zugentlastung B						Mechanical strain relief B	
G	>Ø< min mm	>Ø< max mm		H mm	L mm	Art.-Nr.   Art. No.	
Pg 7	4.0	8.0	17	10	5	1807.02	50
Pg 9	6.0	10.0	20	11	6	1809.02	50
Pg 11	6.0	12.0	22	11	6	1811.02	50
Pg 13	7.0	15.0	24	11	7	1813.02	50
Pg 16	9.0	17.0	27	12	7	1816.02	50
Pg 21	12.0	22.0	35	14	8	1821.02	25
Pg 29	18.0	30.0	42	15	8	1829.02	25
Pg 36	24.0	36.0	55	18	10	1836.02	10



- 1
- 2
- 3
- 4
- 5
- 6
- 7
- 8
- 9
- 10
- 11
- 12

# Kabelverschraubungen Progress® Messing mit Trompete

## Cable glands Progress® nickel-plated brass with trumpet

### Kurzes Anschlussgewinde metrisch | Short entry thread metric

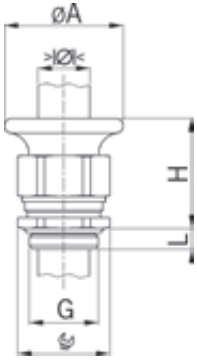

Material: Messing vernickelt  
 Dichtung: TPE  
 O-Ring : NBR  
 Zugentlastung: Ausführung A  
 Einsatztemperatur: -40°C / +100°C  
 Schutzart: IP 68 (bis 10 bar)  
 Weitere Schutzart: IP 69K

Material: Nickel-plated brass  
 Seal: TPE  
 O-ring : NBR  
 Strain relief: Version A  
 Temperature range: -40°C / +100°C  
 Protection class: IP 68 (up to 10 bar)  
 Further protection: IP 69K



#### Progress MS T

Zweiteiliger Dichteinsatz  
 nicht durchgehend isolierend

Two-piece sealing insert  
 not overall length insulated

G	>Ø< min mm	>Ø< max mm		ØA mm	H mm	L mm	Art.-Nr.   Art. No.	
M16x1.5	6.0	10.5	18	28	31	5	1800.10.17	50
M20x1.5	8.0	15.0	24	34	32	6	1800.10.20	50
M25x1.5	12.5	20.5	30	44	38	7	1800.10.25	25
M32x1.5	17.0	25.5	36	50	44	8	1800.10.32	25
M40x1.5	24.0	33.0	46	57	46	8	1800.10.40	10

Erhältlich mit Dichteinsatz gemäß EN 45545. Bei Anfragen oder Bestellung bitte ein F vor die Artikelnummer setzen.

Available with sealing inserts conformity with EN 45545. When placing an inquiry, prefix the article number by the capital F.



### Langes Anschlussgewinde metrisch | Long entry thread metric

#### Progress MS T

Zweiteiliger Dichteinsatz  
 nicht durchgehend isolierend

Two-piece sealing insert  
 not overall length insulated

G	>Ø< min mm	>Ø< max mm		ØA mm	H mm	L mm	Art.-Nr.   Art. No.	
M16x1.5	6.0	10.5	18	28	31	10	1800.11.17	50
M20x1.5	8.0	15.0	24	34	32	10	1800.11.20	50
M25x1.5	12.5	20.5	30	44	38	11	1800.11.25	25
M32x1.5	17.0	25.5	36	50	44	13	1800.11.32	25
M40x1.5	24.0	33.0	46	57	46	13	1800.11.40	10

Erhältlich mit Dichteinsatz gemäß EN 45545. Bei Anfragen oder Bestellung bitte ein F vor die Artikelnummer setzen.

Available with sealing inserts conformity with EN 45545. When placing an inquiry, prefix the article number by the capital F.





# Kabelverschraubungen Progress® Messing mit Trompete

## Cable glands Progress® nickel-plated brass with trumpet

### Kurzes Anschlussgewinde Pg | Short entry thread Pg

Material: Messing vernickelt  
 Dichtung: TPE  
 O-Ring : NBR  
 Einsatztemperatur: -40°C / +100°C  
 Schutzart: IP 68 (bis 10 bar)  
 Weitere Schutzart: IP 69K

Material: Nickel-plated brass  
 Seal: TPE  
 O-ring : NBR  
 Temperature range: -40°C / +100°C  
 Protection class: IP 68 (up to 10 bar)  
 Further protection: IP 69K

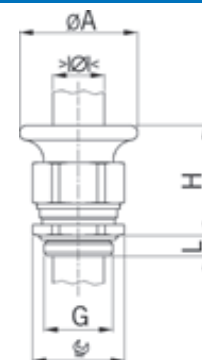

#### Progress MS T

Zweiteiliger Dichteinsatz  
 nicht durchgehend isolierend

Two-piece sealing insert  
 not overall length insulated

G	>Ø< min mm	>Ø< max mm	PG	ØA mm	H mm	L mm	Art.-Nr.   Art. No.	
Pg 9	6.0	10.5	18	28	31	6	1800.10.09	50
Pg 11	5.5	12.0	21	30	31	6	1800.10.11	50
Pg 13	8.0	15.0	24	34	32	6	1800.10.13	50
Pg 16	8.0	15.0	24	34	32	6	1800.10.16	50
Pg 21	12.5	20.5	30	44	38	7.5	1800.10.21	25
Pg 29	19.0	27.5	38	50	44	8	1800.10.29	10

Erhältlich mit Dichteinsatz gemäß EN 45545. Bei Anfragen oder Bestellung bitte ein F vor die Artikelnummer setzen.

Available with sealing inserts conformity with EN 45545. When placing an inquiry, prefix the article number by the capital F.



### Langes Anschlussgewinde Pg | Long entry thread Pg

#### Progress MS T

Zweiteiliger Dichteinsatz  
 nicht durchgehend isolierend

Two-piece sealing insert  
 not overall length insulated

G	>Ø< min mm	>Ø< max mm	PG	ØA mm	H mm	L mm	Art.-Nr.   Art. No.	
Pg 9	6.0	10.5	18	28	31	10	1800.11.09	50
Pg 11	5.5	12.0	21	30	31	10	1800.11.11	50
Pg 13	8.0	15.0	24	34	32	10	1800.11.13	50
Pg 16	8.0	15.0	24	34	32	10	1800.11.16	50
Pg 21	12.5	20.5	30	44	38	12	1800.11.21	25
Pg 29	19.0	27.5	38	50	44	12	1800.11.29	10

Erhältlich mit Dichteinsatz gemäß EN 45545. Bei Anfragen oder Bestellung bitte ein F vor die Artikelnummer setzen.

Available with sealing inserts conformity with EN 45545. When placing an inquiry, prefix the article number by the capital F.



# Kabelverschraubungen Progress® Messing mit Trompete / Klemmbacken

## Cable glands Progress® nickel-plated brass with trumpet / clamps

### Kurzes Anschlussgewinde metrisch | Short entry thread metric

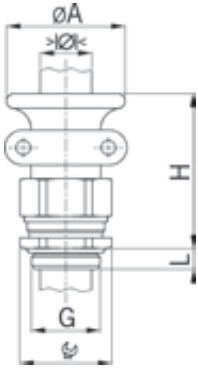

Material: Messing vernickelt  
 Klemmschrauben: Rostfreier Stahl A2  
 Dichtung: TPE  
 O-Ring : NBR  
 Zugentlastung: Ausführung B  
 Einsatztemperatur: -40°C / +100°C  
 Schutzart: IP 68 (bis 10 bar)  
 Weitere Schutzart: IP 69K

Material: Nickel-plated brass  
 Screws: Stainless steel A2  
 Seal: TPE  
 O-ring : NBR  
 Strain relief: Version B  
 Temperature range: -40°C / +100°C  
 Protection class: IP 68 (up to 10 bar)  
 Further protection: IP 69K



#### Progress MS T+KB

Zweiteiliger Dichteinsatz  
 nicht durchgehend isolierend

Two-piece sealing insert  
 not overall length insulated



G	>Ø< min mm	>Ø< max mm		ØA mm	H mm	L mm	Art.-Nr.   Art. No.	
M16x1.5	6.0	10.5	18	28	43	5	1801.10.17	50
M20x1.5	8.0	15.0	24	34	46	6	1801.10.20	50
M25x1.5	12.5	20.5	30	44	52	7	1801.10.25	25
M32x1.5	17.0	25.5	36	50	59	8	1801.10.32	10
M40x1.5	24.0	33.0	46	57	59	8	1801.10.40	5

Erhältlich mit Dichteinsatz gemäß EN 45545. Bei Anfragen oder Bestellung bitte ein F vor die Artikelnummer setzen.

Available with sealing inserts conformity with EN 45545. When placing an inquiry, prefix the article number by the capital F.

### Langes Anschlussgewinde metrisch | Long entry thread metric

#### Progress MS T+KB

Zweiteiliger Dichteinsatz  
 nicht durchgehend isolierend

Two-piece sealing insert  
 not overall length insulated



G	>Ø< min mm	>Ø< max mm		ØA mm	H mm	L mm	Art.-Nr.   Art. No.	
M16x1.5	6.0	10.5	18	28	43	10	1801.11.17	50
M20x1.5	8.0	15.0	24	34	46	10	1801.11.20	50
M25x1.5	12.5	20.5	30	44	52	11	1801.11.25	25
M32x1.5	17.0	25.5	36	50	59	13	1801.11.32	10
M40x1.5	24.0	33.0	46	57	59	13	1801.11.40	5

Erhältlich mit Dichteinsatz gemäß EN 45545. Bei Anfragen oder Bestellung bitte ein F vor die Artikelnummer setzen.

Available with sealing inserts conformity with EN 45545. When placing an inquiry, prefix the article number by the capital F.

# Kabelverschraubungen Progress® Messing mit Trompete / Klemmbacken

## Cable glands Progress® nickel-plated brass with trumpet / clamps

### Kurzes Anschlussgewinde Pg | Short entry thread Pg

Material: Messing vernickelt  
 Klemmschrauben: Rostfreier Stahl A2  
 Dichtung: TPE  
 O-Ring : NBR  
 Einsatztemperatur: -40°C / +100°C  
 Schutzart: IP 68 (bis 10 bar)  
 Weitere Schutzart: IP 69K

Material: Nickel-plated brass  
 Screws: Stainless steel A2  
 Seal: TPE  
 O-ring : NBR  
 Temperature range: -40°C / +100°C  
 Protection class: IP 68 (up to 10 bar)  
 Further protection: IP 69K

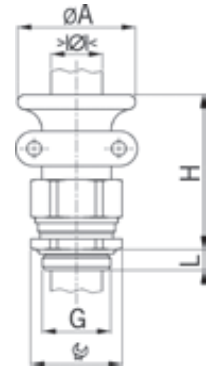

#### Progress MS T+KB

Zweiteiliger Dichteinsatz nicht durchgehend isolierend		Two-piece sealing insert not overall length insulated						Art.-Nr.   Art. No.	
G	> Ø < min mm	> Ø < max mm		ØA mm	H mm	L mm			
Pg 9	6.0	10.5	18	28	43	6	1801.10.09	50	
Pg 11	5.5	12.0	21	30	43	6	1801.10.11	50	
Pg 13	8.0	15.0	24	34	46	6	1801.10.13	50	
Pg 16	8.0	15.0	24	34	46	6	1801.10.16	50	
Pg 21	12.5	20.5	30	44	52	7.5	1801.10.21	25	
Pg 29	19.0	27.5	38	50	59	8	1801.10.29	10	

Erhältlich mit Dichteinsatz gemäß EN 45545. Bei Anfragen oder Bestellung bitte ein F vor die Artikelnummer setzen.

Available with sealing inserts conformity with EN 45545. When placing an inquiry, prefix the article number by the capital F.



### Langes Anschlussgewinde Pg | Long entry thread Pg

#### Progress MS T+KB

Zweiteiliger Dichteinsatz nicht durchgehend isolierend		Two-piece sealing insert not overall length insulated						Art.-Nr.   Art. No.	
G	> Ø < min mm	> Ø < max mm		ØA mm	H mm	L mm			
Pg 9	6.0	10.5	18	28	43	10	1801.11.09	50	
Pg 11	5.5	12.0	21	30	43	10	1801.11.11	50	
Pg 13	8.0	15.0	24	34	46	10	1801.11.13	50	
Pg 16	8.0	15.0	24	34	46	10	1801.11.16	50	
Pg 21	12.5	20.5	30	44	52	12	1801.11.21	25	
Pg 29	19.0	27.5	38	50	59	12	1801.11.29	10	

Erhältlich mit Dichteinsatz gemäß EN 45545. Bei Anfragen oder Bestellung bitte ein F vor die Artikelnummer setzen.

Available with sealing inserts conformity with EN 45545. When placing an inquiry, prefix the article number by the capital F.



# Kabelverschraubungen Progress® aus rostfreiem Stahl

## Cable glands Progress® stainless steel

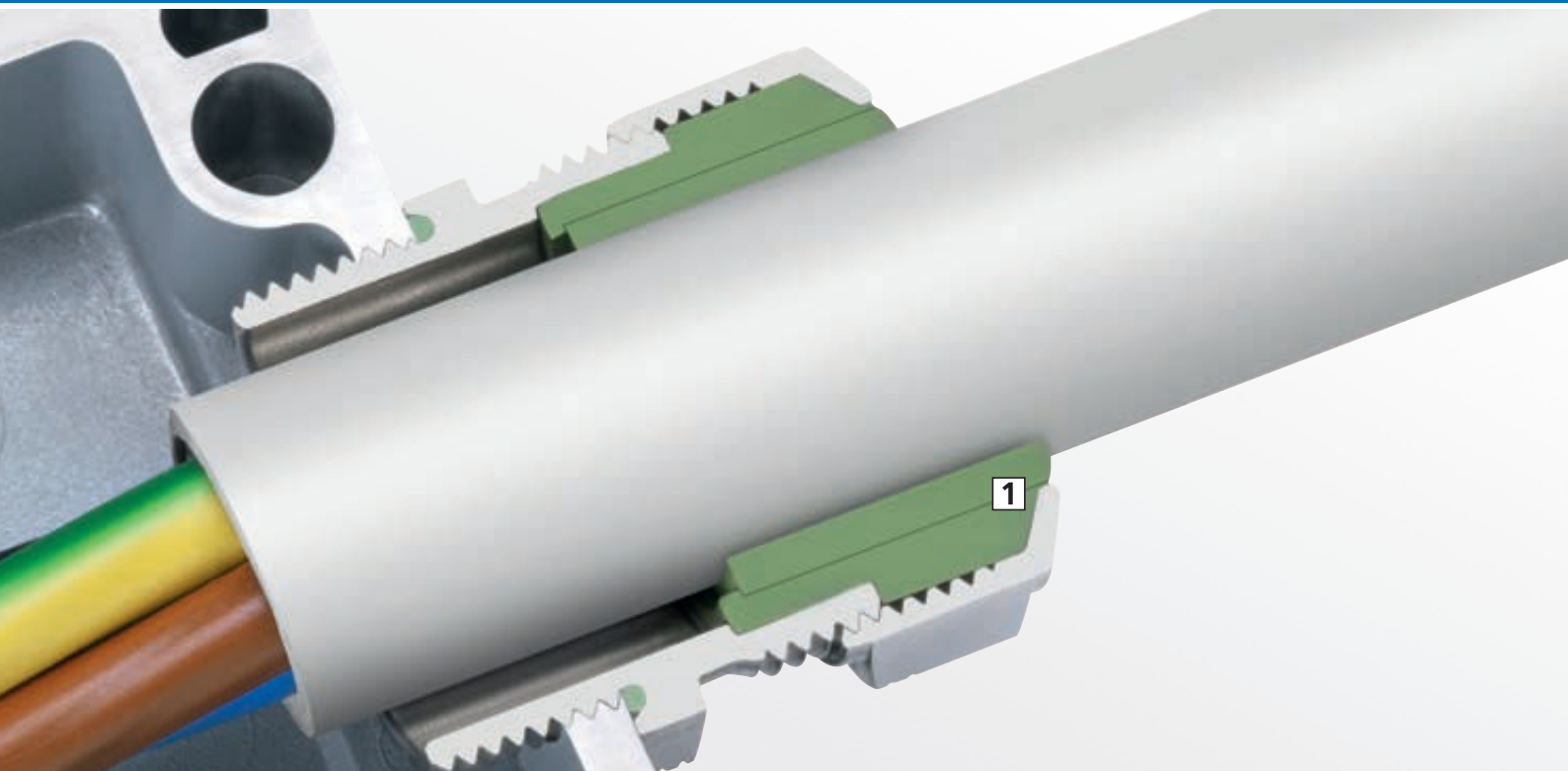

### AGRO Kabelverschraubungen Progress® aus rostfreiem Stahl

weisen eine hohe Korrosionsbeständigkeit und Langlebigkeit auf. Sie sind prädestiniert für den erschwerten Einsatz in der Lebensmittel sowie chemischen Industrie oder auch an Orten mit besonderen Umweltbedingungen wie z.B. in Tunneln oder auf hoher See. Rostfreie Stähle werden durch die zugeordnete Werkstoffnummer eindeutig spezifiziert. AGRO verwendet für die Kabelverschraubungen den rostfreien Stahl A2 mit der Werkstoffnummer 1.4305 (AISI 303) und für den rostfreien und säurebeständigen Stahl A4 den Werkstoff 1.4435 (AISI 316L).

#### 1 Garantierte Dichtigkeit

Auf den Dichteinsatz abgestimmte Innenkonturen sorgen für eine zielgerichtete Verformung des Dichteinsatzes und garantieren somit dessen perfekte Abdichtung. Die Schutzart IP 68 bis 10 bar sowie IP 69K ermöglichen eine breite Anwendung.

### AGRO cable glands Progress® made of stainless steel

are highly corrosion-proof and persistent. They are favorable for any application in food or chemical industries or under difficult environmental conditions such as tunnels or in offshore zones. Stainless steels are specified unequivocally by the allocated material number. For the cable glands, ARGO uses the stainless steel A2 with the material number 1.4305 (AISI 303) and for the stainless and acid-resistant steel A4 the material 1.4435 (AISI 316L).

#### 1 Guaranteed seal

Inner contours matched to the sealing insert ensure a targeted deformation of the insert and thus guarantee its tightness in compliance with protection class IP 68 up to 10 bar and IP 69K for a wide range of applications.

### Kennzeichnung Stahltyp

#### Identification marks of steel type



**1 Rille** kennzeichnet **Stahl A2**.  
Dichteinsatz in TPE (schwarz)

1 groove identifies steel A2.  
Sealing insert TPE (black).

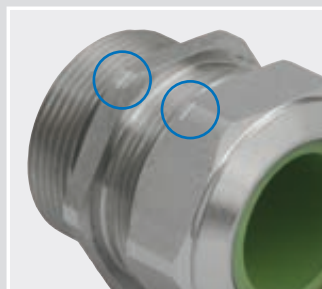

**1 Rille** kennzeichnet **Stahl A2**.  
Dichteinsatz in FPM für hohe Temperaturen (grün)

1 groove identifies steel A2.  
Sealing insert FPM for high temperature applications (green).

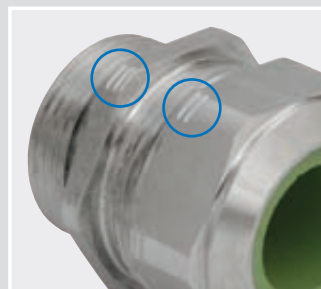

**2 Rillen** kennzeichnen **Stahl A4**.  
Dichteinsatz in FPM für hohe Temperaturen und Säurebeständigkeit (grün)

2 grooves identify steel A4.  
Sealing insert FPM for high temperature applications and resistant to acids (green).



Kabelverschraubungen Progress® rostfreier Stahl A2  
Cable glands Progress® stainless steel A2



Kabelverschraubungen Progress® rostfreier Stahl A2 für hohe Temperaturen  
Cable glands Progress® stainless steel A2 for high temperature applications



Kabelverschraubungen Progress® rostfreier und säurebeständiger Stahl A4 für hohe Temperaturen  
Cable glands Progress® stainless and acid-resistant steel A4 for high temperature applications



Kabelverschraubungen Progress®  
Cable glands Progress®

rostfreier Stahl A2  
stainless steel A2

rostfreier Stahl A2  
für hohe Temperaturen  
stainless steel A2  
for high temperature

rostfreier und säurebeständiger  
Stahl A4 für hohe Temperaturen  
stainless and acid-resistant steel A4  
for high temperature applications

Ausführung / Version				
Kompressionstechnik Compression technology		•	•	•
Gewinde / Thread				
Anschlussgewinde metrisch Entry thread metric		•	•	•
Anschlussgewinde Pg Entry thread Pg		•	•	•
Langes Anschlussgewinde Long entry thread		•	•	•
Kurzes Anschlussgewinde (Standard) Short entry thread (standard)		A	A	A
Dichteinsatz / Sealing insert				
für Rundkabel for round cables		•	•	•
für mehrere Kabel (Multi-Dichteinsatz) for multi sealing insert		A	A	A
Dichteinsatz ohne Bohrung Sealing insert without drilled hole		A	A	A
Einteiliger Dichteinsatz One-piece sealing insert		•	•	•
Zweiteiliger Dichteinsatz Two-piece sealing insert		•	•	•
Dichteinsatz für EN 45545 Sealing insert for EN 45545		•	-	-
Technische Besonderheiten / Technical features				
Hohe Säurebeständigkeit High acid-resistant		-	-	•
Material / Material				
rostfreier Stahl A2 Stainless steel A2		•	•	-
rostfreier Stahl A4 Stainless steel A4		-	-	•

A = Auf Anfrage / upon request

1  
2  
3  
4  
5  
6  
7  
8  
9  
10  
11  
12



# Kabelverschraubungen Progress® rostfreier Stahl A2

## Cable glands Progress® stainless steel A2

### Langes Anschlussgewinde metrisch | Long entry thread metric

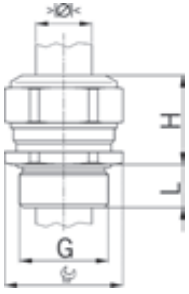

Material: Rostfreier CrNi-Stahl A2 (DIN EN 1.4305 / AISI 303)  
 Kennzeichnung: 1 Rille  
 Dichtung: TPE  
 O-Ring : NBR  
 Zugentlastung: Ausführung A  
 Einsatztemperatur: -40°C / +100°C  
 Schutzart: IP 68 (bis 10 bar)  
 Weitere Schutzart: IP 69K

Material: CrNi stainless steel A2 (DIN EN 1.4305 / AISI 303)  
 Identification: 1 groove  
 Seal: TPE  
 O-ring : NBR  
 Strain relief: Version A  
 Temperature range: -40°C / +100°C  
 Protection class: IP 68 (up to 10 bar)  
 Further protection: IP 69K



#### Progress S2

Einteiliger Dichteinsatz  
nicht durchgehend isolierend

One-piece sealing insert  
not overall length insulated

G	>Ø< min mm	>Ø< max mm		H mm	L mm	i info	Art.-Nr.   Art. No.	
M8x1.25	2.5	3.5	11	14	10	1	1100.08.94.035	50
M8x1.25	3.5	5.0	11	14	10	1	1100.08.94.050	50
M10x1.5	3.0	4.0	13	15	10	1	1100.10.94.040	50
M10x1.5	4.0	6.0	13	15	10	1	1100.10.94.060	50
M12x1.5	3.5	5.0	17	17	10	-	1100.12.94.050	50
M12x1.5	5.0	6.5	17	17	10	-	1100.12.94.065	50
M12x1.5	6.5	8.0	17	17	10	-	1100.12.94.080	50
M16x1.5	8.0	10.5	19	20	10	-	1100.17.94.105	50
M20x1.5	11.0	15.0	24	21	10	-	1100.20.94.150	50
M25x1.5	16.0	20.5	30	25	11	-	1100.25.94.205	25
M32x1.5	21.0	25.5	36	28	13	-	1100.32.94.255	25
M40x1.5	28.5	33.0	46	31	13	-	1100.40.94.330	10
M50x1.5	37.0	42.0	55	34	14	-	1100.50.94.420	10
M63x1.5	46.0	52.0	70	37	14	-	1100.63.94.520	5

1 = Metrisches Regelgewinde

1 = Metric coarse-pitch thread

Erhältlich mit Dichteinsatz gemäß EN 45545. Bei Anfragen oder Bestellung bitte ein F vor die Artikelnummer setzen.

Available with sealing inserts conformity with EN 45545. When placing an inquiry, prefix the article number by the capital F.



#### Progress S2

Zweiteiliger Dichteinsatz  
nicht durchgehend isolierend

Two-piece sealing insert  
not overall length insulated

G	>Ø< min mm	>Ø< max mm		H mm	L mm	Art.-Nr.   Art. No.	
M16x1.5	6.0	10.5	19	20	10	1100.17.94	50
M20x1.5	8.0	15.0	24	21	10	1100.20.94	50
M25x1.5	12.5	20.5	30	25	11	1100.25.94	25
M32x1.5	17.0	25.5	36	28	13	1100.32.94	25
M40x1.5	24.0	33.0	46	31	13	1100.40.94	10
M50x1.5	33.0	42.0	55	34	14	1100.50.94	10
M63x1.5	40.0	52.0	70	37	14	1100.63.94	5

Erhältlich mit Dichteinsatz gemäß EN 45545. Bei Anfragen oder Bestellung bitte ein F vor die Artikelnummer setzen.

Available with sealing inserts conformity with EN 45545. When placing an inquiry, prefix the article number by the capital F.

# Kabelverschraubungen Progress® rostfreier Stahl A2

## Cable glands Progress® stainless steel A2

### Langes Anschlussgewinde Pg | Long entry thread Pg

Material: Rostfreier CrNi-Stahl A2  
(DIN EN 1.4305 /  
AISI 303)

Kennzeichnung: 1 Rille

Dichtung: TPE

O-Ring : NBR

Einsatztemperatur: -40°C / +100°C

Schutzart: IP 68 (bis 10 bar)

Weitere Schutzart: IP 69K

Material: CrNi stainless steel A2  
(DIN EN 1.4305 /  
AISI 303)

Identification: 1 groove

Seal: TPE

O-ring : NBR

Temperature range: -40°C / +100°C

Protection class: IP 68 (up to 10 bar)

Further protection: IP 69K

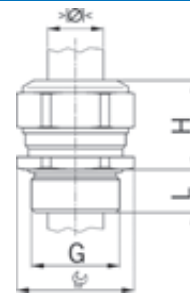

#### Progress S2



Einteiliger Dichteinsatz  
nicht durchgehend isolierend

One-piece sealing insert  
not overall length insulated

G	$\gt;\varnothing<$ min mm	$\gt;\varnothing<$ max mm		H mm	L mm	Art.-Nr.   Art. No.	
Pg 7	3.5	5.0	17	17	10	1100.07.94.050	50
Pg 7	5.0	6.5	17	17	10	1100.07.94.065	50
Pg 7	6.5	8.0	17	17	10	1100.07.94.080	50
Pg 9	8.0	10.5	19	20	10	1100.09.94.105	50
Pg 11	8.5	12.0	22	21	10	1100.11.94.120	50
Pg 13	11.0	15.0	24	21	10	1100.13.94.150	50
Pg 16	11.0	15.0	24	21	10	1100.16.94.150	50
Pg 21	16.0	20.5	30	25	12	1100.21.94.205	25
Pg 29	23.0	27.5	41	28	12	1100.29.94.275	25
Pg 36	30.5	35.0	50	32	15	1100.36.94.350	10
Pg 42	37.0	42.0	55	34	15	1100.42.94.420	10
Pg 48	43.0	49.0	65	37	15	1100.48.94.490	10

Erhältlich mit Dichteinsatz gemäß EN 45545. Bei Anfragen  
oder Bestellung bitte ein F vor die Artikelnummer setzen.

Available with sealing inserts conformity with EN 45545.  
When placing an inquiry, prefix the article number by the  
capital F.



#### Progress S2



Zweiteiliger Dichteinsatz  
nicht durchgehend isolierend

Two-piece sealing insert  
not overall length insulated

G	$\gt;\varnothing<$ min mm	$\gt;\varnothing<$ max mm		H mm	L mm	Art.-Nr.   Art. No.	
Pg 9	6.0	10.5	19	20	10	1100.09.94	50
Pg 11	5.5	12.0	21	21	10	1100.11.94	50
Pg 13	8.0	15.0	24	21	10	1100.13.94	50
Pg 16	8.0	15.0	24	21	10	1100.16.94	50
Pg 21	12.5	20.5	30	25	12	1100.21.94	25
Pg 29	19.0	27.5	41	28	12	1100.29.94	25
Pg 36	26.0	35.0	50	32	15	1100.36.94	10
Pg 42	33.0	42.0	55	34	15	1100.42.94	10
Pg 48	37.0	49.0	65	37	15	1100.48.94	10

Erhältlich mit Dichteinsatz gemäß EN 45545. Bei Anfragen  
oder Bestellung bitte ein F vor die Artikelnummer setzen.

Available with sealing inserts conformity with EN 45545.  
When placing an inquiry, prefix the article number by the  
capital F.



# Kabelverschraubungen Progress® rostfreier Stahl A2 für hohe Temperaturen

## Cable glands Progress® stainless steel A2 for high temperature applications

### Langes Anschlussgewinde metrisch | Long entry thread metric

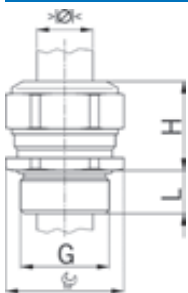

Material: Rostfreier CrNi-Stahl A2 (DIN EN 1.4305 / AISI 303)  
 Kennzeichnung: 1 Rille  
 Dichtung: FPM  
 O-Ring : FPM  
 Zugentlastung: Ausführung A  
 Einsatztemperatur: -40°C / +200°C  
 Schutzart: IP 68 (bis 10 bar)  
 Weitere Schutzart: IP 69K

Material: CrNi stainless steel A2 (DIN EN 1.4305 / AISI 303)  
 Identification: 1 groove  
 Seal: FPM  
 O-ring : FPM  
 Strain relief: Version A  
 Temperature range: -40°C / +200°C  
 Protection class: IP 68 (up to 10 bar)  
 Further protection: IP 69K



#### Progress S2 HT



Einteiliger Dichteinsatz  
nicht durchgehend isolierend

One-piece sealing insert  
not overall length insulated

G	>Ø< min mm	>Ø< max mm		H mm	L mm	i info	Art.-Nr.   Art. No.	
M8x1.25	2.5	3.5	11	14	10	1	1100.08.96.035	50
M8x1.25	3.5	5.0	11	14	10	1	1100.08.96.050	50
M10x1.5	3.0	4.0	13	15	10	1	1100.10.96.040	50
M10x1.5	4.0	6.0	13	15	10	1	1100.10.96.060	50
M12x1.5	3.5	5.0	17	17	10	-	1100.12.96.050	50
M12x1.5	5.0	6.5	17	17	10	-	1100.12.96.065	50
M12x1.5	6.5	8.0	17	17	10	-	1100.12.96.080	50
M16x1.5	8.0	10.5	19	20	10	-	1100.17.96.105	50
M20x1.5	11.0	15.0	24	21	10	-	1100.20.96.150	50
M25x1.5	16.0	20.5	30	25	11	-	1100.25.96.205	25
M32x1.5	21.0	25.5	36	28	13	-	1100.32.96.255	25
M40x1.5	28.5	33.0	46	31	13	-	1100.40.96.330	10
M50x1.5	37.0	42.0	55	34	14	-	1100.50.96.420	10
M63x1.5	46.0	52.0	70	37	14	-	1100.63.96.520	5

1 = Metrisches Regelgewinde

1 = Metric coarse-pitch thread

#### Progress S2 HT



Zweiteiliger Dichteinsatz  
nicht durchgehend isolierend

Two-piece sealing insert  
not overall length insulated

G	>Ø< min mm	>Ø< max mm		H mm	L mm	Art.-Nr.   Art. No.	
M16x1.5	6.0	10.5	19	20	10	1100.17.96	50
M20x1.5	8.0	15.0	24	21	10	1100.20.96	50
M25x1.5	12.5	20.5	30	25	11	1100.25.96	25
M32x1.5	17.0	25.5	36	28	13	1100.32.96	25
M40x1.5	24.0	33.0	46	31	13	1100.40.96	10
M50x1.5	33.0	42.0	55	34	14	1100.50.96	10
M63x1.5	40.0	52.0	70	37	14	1100.63.96	5

# Kabelverschraubungen Progress® rostfreier Stahl A2 für hohe Temperaturen

## Cable glands Progress® stainless steel A2 for high temperature applications

### Langes Anschlussgewinde Pg | Long entry thread Pg

Material: Rostfreier CrNi-Stahl A2  
(DIN EN 1.4305 /  
AISI 303)

Kennzeichnung: 1 Rille

Dichtung: FPM

O-Ring : FPM

Einsatztemperatur: -40°C / +200°C

Schutzart: IP 68 (bis 10 bar)

Weitere Schutzart: IP 69K

Material: CrNi stainless steel A2  
(DIN EN 1.4305 /  
AISI 303)

Identification: 1 groove

Seal: FPM

O-ring : FPM

Temperature range: -40°C / +200°C

Protection class: IP 68 (up to 10 bar)

Further protection: IP 69K

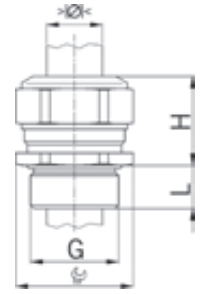

#### Progress S2 HT

Einteiliger Dichteinsatz  
nicht durchgehend isolierend

One-piece sealing insert  
not overall length insulated

G	> Ø < min mm	> Ø < max mm		H mm	L mm	Art.-Nr.   Art. No.	
Pg 7	3.5	5.0	17	17	10	1100.07.96.050	50
Pg 7	5.0	6.5	17	17	10	1100.07.96.065	50
Pg 7	6.5	8.0	17	17	10	1100.07.96.080	50
Pg 9	8.0	10.5	19	20	10	1100.09.96.105	50
Pg 11	8.5	12.0	22	21	10	1100.11.96.120	50
Pg 13	11.0	15.0	24	21	10	1100.13.96.150	50
Pg 16	11.0	15.0	24	21	10	1100.16.96.150	50
Pg 21	16.0	20.5	30	25	12	1100.21.96.205	25
Pg 29	23.0	27.5	41	28	12	1100.29.96.275	25
Pg 36	30.5	35.0	50	32	15	1100.36.96.350	10
Pg 42	37.0	42.0	55	34	15	1100.42.96.420	10
Pg 48	43.0	49.0	65	37	15	1100.48.96.490	10



#### Progress S2 HT

Zweiteiliger Dichteinsatz  
nicht durchgehend isolierend

Two-piece sealing insert  
not overall length insulated

G	> Ø < min mm	> Ø < max mm		H mm	L mm	Art.-Nr.   Art. No.	
Pg 9	6.0	10.5	19	20	10	1100.09.96	50
Pg 11	5.5	12.0	22	21	10	1100.11.96	50
Pg 13	8.0	15.0	24	21	10	1100.13.96	50
Pg 16	8.0	15.0	24	21	10	1100.16.96	50
Pg 21	12.5	20.5	30	25	12	1100.21.96	25
Pg 29	19.0	27.5	41	28	12	1100.29.96	25
Pg 36	26.0	35.0	50	32	15	1100.36.96	10
Pg 42	33.0	42.0	55	34	15	1100.42.96	10
Pg 48	37.0	49.0	65	37	15	1100.48.96	10



**Langes Anschlussgewinde metrisch | Long entry thread metric**

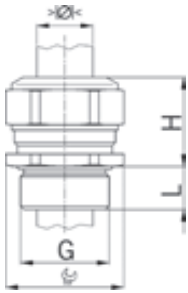

Material: Rostfreier und säurebeständiger CrNiMo-Stahl A4 (DIN EN 1.4435 / AISI 316L)  
 Kennzeichnung: 2 Rillen  
 Dichtung: FPM  
 O-Ring : FPM  
 Zugentlastung: Ausführung A  
 Einsatztemperatur: -40°C / +200°C  
 Schutzart: IP 68 (bis 10 bar)  
 Weitere Schutzart: IP 69K

Material: Stainless and acid resistant steel A4 CrNiMo (DIN EN 1.4435 / AISI 316L)  
 Identification: 2 grooves  
 Seal: FPM  
 O-ring : FPM  
 Strain relief: Version A  
 Temperature range: -40°C / +200°C  
 Protection class: IP 68 (up to 10 bar)  
 Further protection: IP 69K



**Progress S4 HT**



Einteiliger Dichteinsatz  
 nicht durchgehend isolierend

One-piece sealing insert  
 not overall length insulated

G	>Ø< min mm	>Ø< max mm	mm	H mm	L mm	i info	Art.-Nr.   Art. No.	
M8x1.25	2.5	3.5	11	14	10	1	1100.08.98.035	50
M8x1.25	3.5	5.0	11	14	10	1	1100.08.98.050	50
M10x1.5	3.0	4.0	13	15	10	1	1100.10.98.040	50
M10x1.5	4.0	6.0	13	15	10	1	1100.10.98.060	50
M12x1.5	3.5	5.0	17	17	10	-	1100.12.98.050	50
M12x1.5	5.0	6.5	17	17	10	-	1100.12.98.065	50
M12x1.5	6.5	8.0	17	17	10	-	1100.12.98.080	50
M16x1.5	8.0	10.5	19	20	10	-	1100.17.98.105	50
M20x1.5	11.0	15.0	24	21	10	-	1100.20.98.150	50
M25x1.5	16.0	20.5	30	25	11	-	1100.25.98.205	25
M32x1.5	21.0	25.5	36	28	13	-	1100.32.98.255	25
M40x1.5	28.5	33.0	46	31	13	-	1100.40.98.330	10
M50x1.5	37.0	42.0	55	34	14	-	1100.50.98.420	10
M63x1.5	46.0	52.0	70	37	14	-	1100.63.98.520	5

1 = Metrisches Regelgewinde

1 = Metric coarse-pitch thread

**Progress S4 HT**



Zweiteiliger Dichteinsatz  
 nicht durchgehend isolierend

Two-piece sealing insert  
 not overall length insulated

G	>Ø< min mm	>Ø< max mm	mm	H mm	L mm	Art.-Nr.   Art. No.	
M16x1.5	6.0	10.5	19	20	10	1100.17.98	50
M20x1.5	8.0	15.0	24	21	10	1100.20.98	50
M25x1.5	12.5	20.5	30	25	11	1100.25.98	25
M32x1.5	17.0	25.5	36	28	13	1100.32.98	25
M40x1.5	24.0	33.0	46	31	13	1100.40.98	10
M50x1.5	33.0	42.0	55	34	14	1100.50.98	10
M63x1.5	40.0	52.0	70	37	14	1100.63.98	5





Langes Anschlussgewinde Pg | Long entry thread Pg

Material:	Rostfreier und säurebeständiger CrNiMo-Stahl A4 (DIN EN 1.4435 / AISI 316L)	Material:	Stainless and acid resistant steel A4 CrNiMo (DIN EN 1.4435 / AISI 316L)
Kennzeichnung:	2 Rillen	Identification:	2 grooves
Dichtung:	FPM	Seal:	FPM
O-Ring :	FPM	O-ring :	FPM
Einsatztemperatur:	-40°C / +200°C	Temperature range:	-40°C / +200°C
Schutzart:	IP 68 (bis 10 bar)	Protection class:	IP 68 (up to 10 bar)
Weitere Schutzart:	IP 69K	Further protection:	IP 69K

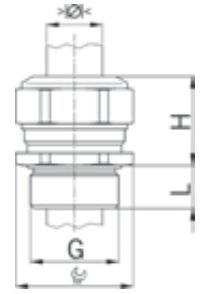

Progress S4 HT



Einteiliger Dichteinsatz nicht durchgehend isolierend						One-piece sealing insert not overall length insulated	
G	> Ø < min mm	> Ø < max mm		H mm	L mm	Art.-Nr.   Art. No.	
Pg 7	3.5	5.0	17	17	10	1100.07.98.050	50
Pg 7	5.0	6.5	17	17	10	1100.07.98.065	50
Pg 7	6.5	8.0	17	17	10	1100.07.98.080	50
Pg 9	8.0	10.5	19	20	10	1100.09.98.105	50
Pg 11	8.5	12.0	22	21	10	1100.11.98.120	50
Pg 13	11.0	15.0	24	21	10	1100.13.98.150	50
Pg 16	11.0	15.0	24	21	10	1100.16.98.150	50
Pg 21	16.0	20.5	30	25	12	1100.21.98.205	25
Pg 29	23.0	27.5	41	28	12	1100.29.98.275	25
Pg 36	30.5	35.0	50	32	15	1100.36.98.350	10
Pg 42	37.0	42.0	55	34	15	1100.42.98.420	10
Pg 48	43.0	49.0	65	37	15	1100.48.98.490	10



Progress S4 HT



Zweiteiliger Dichteinsatz nicht durchgehend isolierend						Two-piece sealing insert not overall length insulated	
G	> Ø < min mm	> Ø < max mm		H mm	L mm	Art.-Nr.   Art. No.	
Pg 9	6.0	10.5	19	20	10	1100.09.98	50
Pg 11	5.5	12.0	22	21	10	1100.11.98	50
Pg 13	8.0	15.0	24	21	10	1100.13.98	50
Pg 16	8.0	15.0	24	21	10	1100.16.98	50
Pg 21	12.5	20.5	30	25	12	1100.21.98	25
Pg 29	19.0	27.5	41	28	12	1100.29.98	25
Pg 36	26.0	35.0	50	32	15	1100.36.98	10
Pg 42	33.0	42.0	55	34	15	1100.42.98	10
Pg 48	37.0	49.0	65	37	15	1100.48.98	10



# Spezielle Kabelverschraubungen und -einführungen aus Messing Special cable glands and cable entries nickel-plated brass



Die **Progress® ultraFLAT** ist eine Kabelverschraubung für vier Anwendungsgebiete - den Reinraum, die Lebensmittelindustrie, den Antivandalismus und das Design. Die ultraflache Konstruktion der Kabelverschraubung **Progress® ultraFLAT** verhindert eine Manipulation von außen. Sie bietet keine Angriffsfläche für eine Beeinträchtigung von Hand oder auch mit Werkzeugen. Außerdem überzeugt die Kabelverschraubung durch ihre schlichte und überaus ansprechende Formgebung für den Einsatz in Design-Applikationen.

Die Kabelverschraubung **Progress® ultraFLAT** bietet wenig Oberfläche, an der sich Verschmutzungen ablagern können - die gute Reinigbarkeit für den Einsatz in Reinräumen oder der Lebensmittelindustrie wird durch die Zertifizierung bei der European Hygienic Engineering & Design Group (EHEDG) bestätigt. Ausführungen in Edelstahl und Dichteinsätze für Hochtemperaturen oder mit FDA Konformität sprechen für diese Wahl.

Sind bei der Kabelinstallation enge Raumverhältnisse gegeben, kann der Anwender auf die Vorteile von **Winkeln und Flanschwinkeln** bauen.

Hier werden Leitungen um die Ecke geführt und je nach der verwendeten Kabelverschraubung zu 100% vor der Knickstelle zugentlastet. Zur Auswahl stehen neben 90°-Winkeln auch 45°-Winkel für eine leichte Biegung des Kabels.

## EHEDG Zertifizierung

Die **European Hygienic Engineering & Design Group** (EHEDG) ist eine Expertengemeinschaft von Maschinen- und Komponenten-Herstellern, Fachleuten aus der Nahrungsmittelindustrie sowie von Forschungsinstituten und Gesundheitsbehörden. Die Organisation wurde 1989 in der Absicht gegründet, das Bewusstsein für Hygiene bei der Verarbeitung und Verpackung von Nahrungsmitteln zu stärken.

Die Hauptaufgabe der EHEDG ist es, zur hygienegerechten Konstruktion und Gestaltung in allen Bereichen der Nahrungsmittelproduktion beizutragen und damit eine sichere Herstellung von Lebensmitteln zu gewährleisten.



## EHEDG Certification

The **European Hygienic Engineering & Design Group** (EHEDG) is a consortium of equipment manufacturers, food industries, research institutes as well as public health authorities and was founded in 1989 with the aim to promote hygiene during the processing and packing of food products.

The principal goal of EHEDG is the promotion of safe food by improving hygienic engineering and design in all aspects of food manufacture.



<p>Kabelverschraubungen Progress® ultraFLAT                  Cable glands Progress® ultraFLAT</p>			<p>68 - 69</p>	<p>1</p>
<p>Kabelverschraubungen Progress® Messing Winkel 90°                  Cable glands Progress® nickel-plated brass elbow 90°</p>			<p>70 - 73</p>	<p>2</p>
<p>Winkel 90° Messing mit Innen- und Außengewinde                  Elbow 90° nickel-plated brass with internal and external thread</p>			<p>74</p>	<p>3</p>
<p>Winkel 45° Messing mit Innen- und Außengewinde                  Elbow 45° nickel-plated brass with internal and external thread</p>			<p>75</p>	<p>4</p>
<p>Flanschwinkel 90° Aluminium                  Flanged elbow 90° aluminum</p>			<p>76</p>	<p>5</p>
<p>Universal Kabeleinführung für Flach- und Rundkabel                  Universal cable entry for flat and round cables</p>			<p>77</p>	<p>6</p>
<p>Stopfbuchsen Messing nach DIN 46320-C4-MS                  Cable glands nickel-plated brass according to DIN 46320-C4-MS</p>			<p>78 - 79</p>	<p>7</p>
<p>Stopfbuchsen Messing mit Klemmbacken                  Cable glands nickel-plated brass with clamps</p>			<p>80</p>	<p>8</p>
<p>Stopfbuchsen Messing mit Trompete und Klemmbacken                  Cable glands nickel-plated brass with trumpet and clamps</p>			<p>81</p>	<p>9</p>
<p>Stopfbuchsen Messing mit Schutztülle und Klemmbacken                  Cable glands nickel-plated brass with antikink nozzle and clamps</p>			<p>82 - 83</p>	<p>10</p>
				<p>11</p>
				<p>12</p>

# Kabelverschraubung Progress® ultraFLAT

## Cable glands Progress® ultraFLAT

Anschlussgewinde metrisch | Entry thread metric

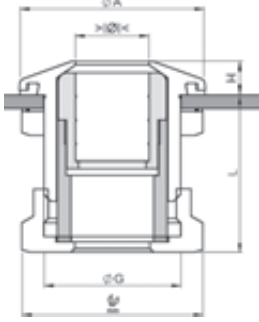

### Kabelverschraubungen Progress® ultraFLAT Messing

Fronting:	Messing halbglanz vernickelt
Druckmutter:	Messing vernickelt
Dichtung:	TPE
Dichtscheibe:	FPM
Zugentlastung:	Ausführung A
Einsatztemperatur:	-40°C / +100°C
Schutzart:	IP 68 (bis 10 bar)
Weitere Schutzart:	IP 69K
Wandstärke:	max. 5 mm

### Cable glands Progress® ultraFLAT nickel-plated brass

Front part:	semi-bright nickel-plated brass
Push-down nut:	Nickel-plated brass
Seal:	TPE
Sealing washer:	FPM
Strain relief:	Version A
Temperature range:	-40°C / +100°C
Protection class:	IP 68 (up to 10 bar)
Further protection:	IP 69K
Wall thickness:	max. 5 mm



Einteiliger Dichteinsatz  
nicht durchgehend isolierend

One-piece sealing insert  
not overall length insulated

G	>Ø< min mm	>Ø< max mm	mm	ØA mm	H mm	L mm	Art.-Nr.   Art. No.	☐
M16x1.5	5.0	6.5	18	22	4.0	21	1040.17.40.065	25
M16x1.5	6.5	8.0	18	22	4.0	21	1040.17.40.080	25
M20x1.5	6.0	8.0	24	27	4.5	23	1040.20.40.080	25
M20x1.5	8.0	10.5	24	27	4.5	23	1040.20.40.105	25
M25x1.5	8.0	11.0	30	32	5.5	25	1040.25.40.110	20
M25x1.5	11.0	15.0	30	32	5.5	25	1040.25.40.150	20
M32x1.5	12.5	16.0	36	39	6.0	28	1040.32.40.160	10
M32x1.5	16.0	20.5	36	39	6.0	28	1040.32.40.205	10

**Auf Anfrage lieferbar:**

Rostfreier und säurebeständiger Stahl A4

**Available on request:**

Stainless steel and acid resistant A4



### Anschlussgewinde metrisch | Entry thread metric

#### Kabelverschraubungen Progress® ultraFLAT rostfreier Stahl A2

Frontring:	Rostfreier Stahl A2
Druckmutter:	Messing vernickelt
Dichtung:	FKM
Dichtscheibe:	FKM
Zugentlastung:	Ausführung A
Einsatztemperatur:	-40°C / +200°C
Schutzart:	IP 68 (bis 10 bar)
Weitere Schutzart:	IP 69K
Wandstärke:	max. 5 mm
Zertifikat:	EHEDG

#### Cable glands Progress® ultraFLAT stainless steel A2

Front part:	Stainless steel A2
Push-down nut:	Nickel-plated brass
Seal:	FKM
Sealing washer:	FKM
Strain relief:	Version A
Temperature range:	-40°C / +200°C
Protection class:	IP 68 (up to 10 bar)
Further protection:	IP 69K
Wall thickness:	max. 5 mm
Certificate:	EHEDG

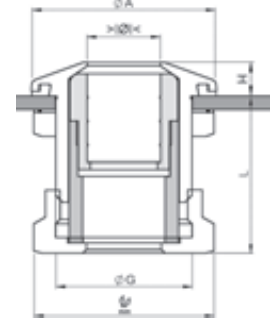

Einteiliger Dichteinsatz  
nicht durchgehend isolierend

One-piece sealing insert  
not overall length insulated

G	>  $\varnothing$  < min mm	>  $\varnothing$  < max mm		$\varnothing A$ mm	H mm	L mm	i info	Art.-Nr.   Art. No.	
M16x1.5	5.0	6.5	18	22	4.0	21	1	1040.17.96.30.065	25
M16x1.5	6.5	8.0	18	22	4.0	21	1	1040.17.96.30.080	25
M20x1.5	6.0	8.0	24	27	4.5	23	1	1040.20.96.30.080	25
M20x1.5	8.0	10.5	24	27	4.5	23	1	1040.20.96.30.105	25
M25x1.5	8.0	11.0	30	32	5.5	25	1	1040.25.96.30.110	20
M25x1.5	11.0	15.0	30	32	5.5	25	1	1040.25.96.30.150	20
M32x1.5	12.5	16.0	36	39	6.0	28	1	1040.32.96.30.160	10
M32x1.5	16.0	20.5	36	39	6.0	28	1	1040.32.96.30.205	10

1 = Lieferbar auf Anfrage  
FDA konforme Dichtungen

1 = Available on request  
FDA cleared sealing inserts



### Anschlussgewinde metrisch | Entry thread metric

#### Kabelverschraubungen Progress ultraFLAT rostfreier Stahl A2 für hohe Temperaturen

Frontring:	Rostfreier Stahl A2
Druckmutter:	Messing vernickelt
Dichtung:	FPM
Dichtscheibe:	FPM
Zugentlastung:	Ausführung A
Einsatztemperatur:	-40°C / +200°C
Schutzart:	IP 68 (bis 10 bar)
Weitere Schutzart:	IP 69K
Wandstärke:	max. 5 mm

#### Cable glands Progress® ultraFLAT stainless steel A2 for high temperature applications

Front part:	Stainless steel A2
Push-down nut:	Nickel-plated brass
Seal:	FPM
Sealing washer:	FPM
Strain relief:	Version A
Temperature range:	-40°C / +200°C
Protection class:	IP 68 (up to 10 bar)
Further protection:	IP 69K
Wall thickness:	max. 5 mm

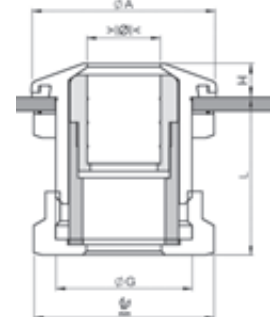

Einteiliger Dichteinsatz  
nicht durchgehend isolierend

One-piece sealing insert  
not overall length insulated

G	>  $\varnothing$  < min mm	>  $\varnothing$  < max mm		$\varnothing A$ mm	H mm	L mm	i info	Art.-Nr.   Art. No.	
M16x1.5	5.0	6.5	18	22	4.0	21	-	1040.17.96.70.065	25
M16x1.5	6.5	8.0	18	22	4.0	21	-	1040.17.96.70.080	25
M20x1.5	6.0	8.0	24	27	4.5	23	1	1040.20.96.70.080	25
M20x1.5	8.0	10.5	24	27	4.5	23	-	1040.20.96.70.105	25
M25x1.5	8.0	11.0	30	32	5.5	25	1	1040.25.96.70.110	20
M25x1.5	11.0	15.0	30	32	5.5	25	-	1040.25.96.70.150	20
M32x1.5	12.5	16.0	36	39	6.0	28	1	1040.32.96.70.160	10
M32x1.5	16.0	20.5	36	39	6.0	28	-	1040.32.96.70.205	10

1 = Lieferbar auf Anfrage

1 = Available on request





# Kabelverschraubungen Progress® Messing Winkel 90°

## Cable glands Progress® nickel-plated brass elbow 90°

### Kurzes Anschlussgewinde metrisch | Short entry thread metric

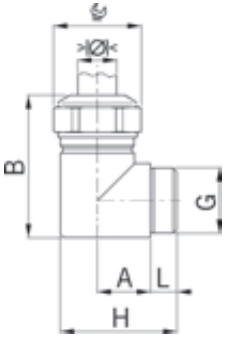

Material: Messing vernickelt  
 Dichtung: TPE  
 Zugentlastung: Ausführung A  
 Einsatztemperatur: -40°C / +100°C  
 Schutzart: IP 68  
 Gewinde: IP 68, wenn Anschlussgewinde abgedichtet

Material: Nickel-plated brass  
 Seal: TPE  
 Strain relief: Version A  
 Temperature range: -40°C / +100°C  
 Protection class: IP 68  
 Entry thread: IP 68, if the entry thread is sealed



#### Progress MS W90

Einteiliger Dichteinsatz  
 nicht durchgehend isolierend

One-piece sealing insert  
 not overall length insulated

G	$> \varnothing <$ min mm	$> \varnothing <$ max mm	 mm	H mm	L mm	A mm	B mm	Art.-Nr.   Art. No.	
M12x1.5	5.0	6.5	15	27	8	11	32	5200.12	50

Erhältlich mit Dichteinsatz gemäß EN 45545. Bei Anfragen oder Bestellung bitte ein F vor die Artikelnummer setzen.

Available with sealing inserts conformity with EN 45545. When placing an inquiry, prefix the article number by the capital F.



#### Progress MS W90

Zweiteiliger Dichteinsatz  
 nicht durchgehend isolierend

Two-piece sealing insert  
 not overall length insulated

G	$> \varnothing <$ min mm	$> \varnothing <$ max mm	 mm	H mm	L mm	A mm	B mm	Art.-Nr.   Art. No.	
M16x1.5	6.0	10.5	18	30	8	13	36	5200.17	50
M20x1.5	8.0	15.0	24	35	8	16	44	5200.20	50
M25x1.5	12.5	20.5	30	44	10	20	52	5200.25	25
M32x1.5	17.0	25.5	36	50	10	23	60	5200.32	25
M40x1.5	24.0	33.0	46	60	10	28	72	5200.40	10

Erhältlich mit Dichteinsatz gemäß EN 45545. Bei Anfragen oder Bestellung bitte ein F vor die Artikelnummer setzen.

Available with sealing inserts conformity with EN 45545. When placing an inquiry, prefix the article number by the capital F.



### Langes Anschlussgewinde metrisch | Long entry thread metric

#### Progress MS W90

Einteiliger Dichteinsatz  
 nicht durchgehend isolierend

One-piece sealing insert  
 not overall length insulated

G	$> \varnothing <$ min mm	$> \varnothing <$ max mm	 mm	H mm	L mm	A mm	B mm	Art.-Nr.   Art. No.	
M12x1.5	5.0	6.5	15	30	12	11	32	5210.12	50

Erhältlich mit Dichteinsatz gemäß EN 45545. Bei Anfragen oder Bestellung bitte ein F vor die Artikelnummer setzen.

Available with sealing inserts conformity with EN 45545. When placing an inquiry, prefix the article number by the capital F.



#### Progress MS W90

Zweiteiliger Dichteinsatz  
 nicht durchgehend isolierend

Two-piece sealing insert  
 not overall length insulated

G	$> \varnothing <$ min mm	$> \varnothing <$ max mm	 mm	H mm	L mm	A mm	B mm	Art.-Nr.   Art. No.	
M16x1.5	6.0	10.5	18	34	12	13	36	5210.17	50
M20x1.5	8.0	15.0	24	39	12	16	44	5210.20	50
M25x1.5	12.5	20.5	30	48	14	20	52	5210.25	25
M32x1.5	17.0	25.5	36	56	16	23	60	5210.32	25
M40x1.5	24.0	33.0	46	66	16	28	72	5210.40	10

Erhältlich mit Dichteinsatz gemäß EN 45545. Bei Anfragen oder Bestellung bitte ein F vor die Artikelnummer setzen.

Available with sealing inserts conformity with EN 45545. When placing an inquiry, prefix the article number by the capital F.



# Kabelverschraubungen Progress® Messing Winkel 90°

## Cable glands Progress® nickel-plated brass elbow 90°

### Kurzes Anschlussgewinde Pg | Short entry thread Pg

Material: Messing vernickelt  
 Dichtung: TPE  
 Einsatztemperatur: -40°C / +100°C  
 Schutzart: IP 68  
 Gewinde: IP 68, wenn Anschlussgewinde abgedichtet

Material: Nickel-plated brass  
 Seal: TPE  
 Temperature range: -40°C / +100°C  
 Protection class: IP 68  
 Entry thread: IP 68, if the entry thread is sealed

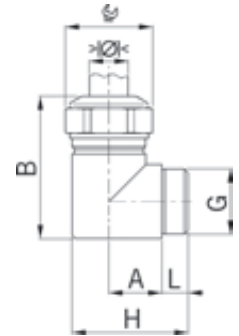

#### Progress MS W90



Einteiliger Dichteinsatz  
 nicht durchgehend isolierend

One-piece sealing insert  
 not overall length insulated

G	$\frac{> \varnothing <}{\text{min mm}}$	$\frac{> \varnothing <}{\text{max mm}}$		H mm	L mm	A mm	B mm	Art.-Nr.   Art. No.	
Pg 7	5.0	6.5	15	27	8	11	32	5200.07	50

Erhältlich mit Dichteinsatz gemäß EN 45545. Bei Anfragen oder Bestellung bitte ein F vor die Artikelnummer setzen.

Available with sealing inserts conformity with EN 45545. When placing an inquiry, prefix the article number by the capital F.



#### Progress MS W90



Zweiteiliger Dichteinsatz  
 nicht durchgehend isolierend

Two-piece sealing insert  
 not overall length insulated

G	$\frac{> \varnothing <}{\text{min mm}}$	$\frac{> \varnothing <}{\text{max mm}}$		H mm	L mm	A mm	B mm	Art.-Nr.   Art. No.	
Pg 9	6.0	10.5	18	30	8	13	36	5200.09	50
Pg 11	5.5	12.0	21	35	8	14	40	5200.11	50
Pg 13	8.0	15.0	24	41	10	16	44	5200.13	50
Pg 16	8.0	15.0	24	41	10	16	44	5200.16	50
Pg 21	12.5	20.5	30	44	10	20	52	5200.21	25
Pg 29	19.0	27.5	38	56	10	24	65	5200.29	10

Erhältlich mit Dichteinsatz gemäß EN 45545. Bei Anfragen oder Bestellung bitte ein F vor die Artikelnummer setzen.

Available with sealing inserts conformity with EN 45545. When placing an inquiry, prefix the article number by the capital F.



### Langes Anschlussgewinde Pg | Long entry thread Pg

#### Progress MS W90



Einteiliger Dichteinsatz  
 nicht durchgehend isolierend

One-piece sealing insert  
 not overall length insulated

G	$\frac{> \varnothing <}{\text{min mm}}$	$\frac{> \varnothing <}{\text{max mm}}$		H mm	L mm	A mm	B mm	Art.-Nr.   Art. No.	
Pg 7	5.0	6.5	15	30	11	11	32	5210.07	50

Erhältlich mit Dichteinsatz gemäß EN 45545. Bei Anfragen oder Bestellung bitte ein F vor die Artikelnummer setzen.

Available with sealing inserts conformity with EN 45545. When placing an inquiry, prefix the article number by the capital F.



#### Progress MS W90



Zweiteiliger Dichteinsatz  
 nicht durchgehend isolierend

Two-piece sealing insert  
 not overall length insulated

G	$\frac{> \varnothing <}{\text{min mm}}$	$\frac{> \varnothing <}{\text{max mm}}$		H mm	L mm	A mm	B mm	Art.-Nr.   Art. No.	
Pg 9	6.0	10.5	18	34	11	13	36	5210.09	50
Pg 11	5.5	12.0	21	38	11	14	40	5210.11	50
Pg 13	8.0	15.0	24	44	13	16	44	5210.13	50
Pg 16	8.0	15.0	24	44	13	16	44	5210.16	50
Pg 21	12.5	20.5	30	48	14	20	52	5210.21	25
Pg 29	19.0	27.5	38	60	14	24	65	5210.29	10

Erhältlich mit Dichteinsatz gemäß EN 45545. Bei Anfragen oder Bestellung bitte ein F vor die Artikelnummer setzen.

Available with sealing inserts conformity with EN 45545. When placing an inquiry, prefix the article number by the capital F.



# Kabelverschraubungen Progress® Messing Winkel 90°

## Cable glands Progress® nickel-plated brass elbow 90°

Langes Anschlussgewinde metrisch mit Gegenmutter | Long entry thread metric with lock nut

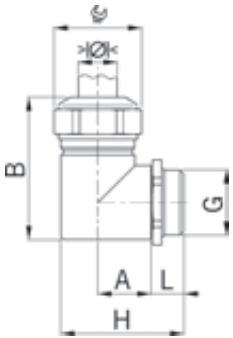

Material: Messing vernickelt  
 Dichtung: TPE  
 O-Ring : NBR  
 Zugentlastung: Ausführung A  
 Einsatztemperatur: -40°C / +100°C  
 Schutzart: IP 68

Material: Nickel-plated brass  
 Seal: TPE  
 O-ring : NBR  
 Strain relief: Version A  
 Temperature range: -40°C / +100°C  
 Protection class: IP 68



### Progress MS W90



Einteiliger Dichteinsatz  
 nicht durchgehend isolierend

One-piece sealing insert  
 not overall length insulated

G	$\gt;\varnothing<$ min mm	$\gt;\varnothing<$ max mm	 mm	H mm	L mm	A mm	B mm	Art.-Nr.   Art. No.	
M12x1.5	5.0	6.5	15	30	12	11	32	5215.12	50

Erhältlich mit Dichteinsatz gemäß EN 45545. Bei Anfragen oder Bestellung bitte ein F vor die Artikelnummer setzen.

Available with sealing inserts conformity with EN 45545. When placing an inquiry, prefix the article number by the capital F.



### Progress MS W90



Zweiteiliger Dichteinsatz  
 nicht durchgehend isolierend

Two-piece sealing insert  
 not overall length insulated

G	$\gt;\varnothing<$ min mm	$\gt;\varnothing<$ max mm	 mm	H mm	L mm	A mm	B mm	Art.-Nr.   Art. No.	
M16x1.5	6.0	10.5	18	34	12	13	36	5215.17	50
M20x1.5	8.0	15.0	24	39	12	16	44	5215.20	50
M25x1.5	12.5	20.5	30	48	14	20	52	5215.25	25
M32x1.5	17.0	25.5	36	56	16	23	60	5215.32	25
M40x1.5	24.0	33.0	46	66	16	28	72	5215.40	10

Erhältlich mit Dichteinsatz gemäß EN 45545. Bei Anfragen oder Bestellung bitte ein F vor die Artikelnummer setzen.

Available with sealing inserts conformity with EN 45545. When placing an inquiry, prefix the article number by the capital F.

# Kabelverschraubungen Progress® Messing Winkel 90°

## Cable glands Progress® nickel-plated brass elbow 90°

Langes Anschlussgewinde Pg mit Gegenmutter | Long entry thread Pg with lock nut

Material: Messing vernickelt  
 Dichtung: TPE  
 O-Ring : NBR  
 Einsatztemperatur: -40°C / +100°C  
 Schutzart: IP 68

Material: Nickel-plated brass  
 Seal: TPE  
 O-ring : NBR  
 Temperature range: -40°C / +100°C  
 Protection class: IP 68

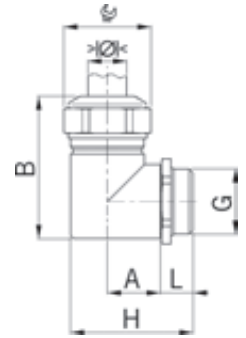

### Progress MS W90



Einteiliger Dichteinsatz  
 nicht durchgehend isolierend

One-piece sealing insert  
 not overall length insulated

G	$\frac{> \varnothing <}{\text{min mm}}$	$\frac{> \varnothing <}{\text{max mm}}$		H mm	L mm	A mm	B mm	Art.-Nr.   Art. No.	
Pg 7	5.0	6.5	15	30	11	11	32	5215.07	50

Erhältlich mit Dichteinsatz gemäß EN 45545. Bei Anfragen oder Bestellung bitte ein F vor die Artikelnummer setzen.

Available with sealing inserts conformity with EN 45545. When placing an inquiry, prefix the article number by the capital F.



### Progress MS W90



Zweiteiliger Dichteinsatz  
 nicht durchgehend isolierend

Two-piece sealing insert  
 not overall length insulated

G	$\frac{> \varnothing <}{\text{min mm}}$	$\frac{> \varnothing <}{\text{max mm}}$		H mm	L mm	A mm	B mm	Art.-Nr.   Art. No.	
Pg 9	6.0	10.5	18	34	11	13	36	5215.09	50
Pg 11	5.5	12.0	21	38	11	14	40	5215.11	50
Pg 13	8.0	15.0	24	44	13	16	44	5215.13	50
Pg 16	8.0	15.0	24	44	13	16	44	5215.16	50
Pg 21	12.5	20.5	30	48	14	20	52	5215.21	25
Pg 29	19.0	27.5	38	60	14	24	65	5215.29	10

Erhältlich mit Dichteinsatz gemäß EN 45545. Bei Anfragen oder Bestellung bitte ein F vor die Artikelnummer setzen.

Available with sealing inserts conformity with EN 45545. When placing an inquiry, prefix the article number by the capital F.



# Winkel 90° Messing mit Innen- und Außengewinde

## Elbow 90° nickel-plated brass with internal and external thread

### Anschlussgewinde metrisch | Entry thread metric

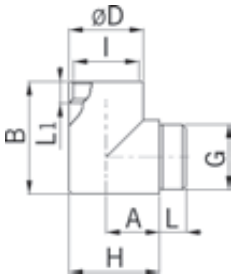

Material: Messing vernickelt  
 O-Ring : NBR  
 Einsatztemperatur: -40°C / +100°C  
 Schutzart: IP 54  
 Weitere Schutzart: IP 68, wenn Anschlussgewinde abgedichtet

Material: Nickel-plated brass  
 O-ring : NBR  
 Temperature range: -40°C / +100°C  
 Protection class: IP 54  
 Further protection: IP 68, if the entry thread is sealed



mit O-Ring		with O-ring						Art.-Nr.   Art. No.	
G	I	D mm	L mm	L1 mm	A mm	B mm	H mm		
M12x1.5	M12x1.5	15	5.0	7	13	25	20	5612	50
M16x1.5	M16x1.5	19	6.5	7	16	29	26	5617	50
M20x1.5	M20x1.5	24	6.0	10	19	37	31	5620	50
M25x1.5	M25x1.5	29	7.5	10	23	42	37	5625	25
M32x1.5	M32x1.5	36	8.5	11	26	50	44	5632	25
M40x1.5	M40x1.5	46	9.5	17	34	67	57	5640	10
M50x1.5	M50x1.5	56	9.0	17	41	77	69	5650	10

### Anschlussgewinde Pg | Entry thread Pg



mit O-Ring		with O-ring						Art.-Nr.   Art. No.	
G	I	D mm	L mm	L1 mm	A mm	B mm	H mm		
Pg 7	Pg 7	16	7	7	13	23	21	5607	50
Pg 9	Pg 9	18	7	7	15	26	24	5609	50
Pg 11	Pg 11	22	8	8	18	31	29	5611	50
Pg 13	Pg 13	24	10	10	19	34	31	5613	50
Pg 16	Pg 16	26	10	10	20	36	33	5616	50
Pg 21	Pg 21	34	11	11	24	46	41	5621	25
Pg 29	Pg 29	41	11	11	28	52	49	5629	20
Pg 36	Pg 36	52	12	17	38	82	64	5636	10



# Winkel 45° Messing mit Innen- und Außengewinde

## Elbows 45° nickel-plated brass with internal and external thread

### Anschlussgewinde metrisch | Entry thread metric

Material: Messing vernickelt  
 O-Ring : NBR  
 Einsatztemperatur: -40°C / +100°C  
 Schutzart: IP 54  
 Weitere Schutzart: IP 68, wenn Anschlussgewinde abgedichtet

Material: Nickel-plated brass  
 O-ring : NBR  
 Temperature range: -40°C / +100°C  
 Protection class: IP 54  
 Further protection: IP 68, if the entry thread is sealed

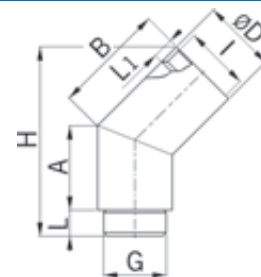

mit O-Ring		with O-ring						Art.-Nr.   Art. No.	
G	I	D mm	L mm	L1 mm	A mm	B mm	H mm		
<b>M16x1.5</b>	M16x1.5	19	6.5	7	13	18	26	<b>5717</b>	50
<b>M20x1.5</b>	M20x1.5	24	6.0	10	17	23	33	<b>5720</b>	50
<b>M25x1.5</b>	M25x1.5	29	7.5	10	18	25	36	<b>5725</b>	25
<b>M32x1.5</b>	M32x1.5	36	8.5	11	21	28	41	<b>5732</b>	25



### Anschlussgewinde Pg | Entry thread Pg

mit O-Ring		with O-ring						Art.-Nr.   Art. No.	
G	I	D mm	L mm	L1 mm	A mm	B mm	H mm		
<b>Pg 11</b>	Pg 11	22	8	11	16	20	30	<b>5711</b>	50
<b>Pg 16</b>	Pg 16	26	10	12	18	23	34	<b>5716</b>	50
<b>Pg 21</b>	Pg 21	34	11	12	21	26	39	<b>5721</b>	25
<b>Pg 29</b>	Pg 29	41	8	16	27	32	-	<b>5729</b>	25



# Flanschwinkel 90° Zinkdruckguss

## Flanged elbow 90° zinc diecasting

### Anschlussgewinde metrisch | Entry thread metric

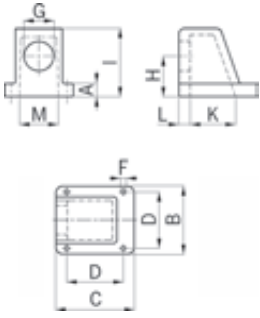

Material: Zinkdruckguss  
 Dichtung: NBR  
 Einsatztemperatur: -40°C / +100°C  
 Schutzart: IP 65  
 Eigenschaften: Für spritzwasserdichte Montage an der Gehäusewandung mit Anschlussgewinde für Kabelverschraubung oder Schlauchverschraubung

Material: Zinc diecasting  
 Seal: NBR  
 Temperature range: -40°C / +100°C  
 Protection class: IP 65  
 Properties: For splash water-proof mounting on casing walls with entry thread for cable glands or conduit glands



mit 1 Anschlussgewinde										with 1 entry thread									
G	B/C mm	D mm	F mm	A mm	H mm	I mm	K mm	L mm	M mm	Art.-Nr.   Art. No.									
M16x1.5	45 x 48	37	4.3	8	15.5	30	28	10.5	24	5517		10							
M20x1.5	53 x 56	44	5.5	8	18.0	35	34	10.5	24	5520		10							
M25x1.5	63 x 65	54	5.5	8	22.5	42	43	11.0	35	5525		5							
M32x1.5	71 x 75	60	5.5	10	27.0	52	53	11.0	38	5532		5							
M40x1.5	71 x 75	60	5.5	10	27.0	52	53	11.0	38	5540		5							
M50x1.5	89 x 93	72	6.5	11	33.5	69	65	18.0	50	5550		2							
M63x1.5	96 x 114	84	4.3	10	37.0	74	86	14.0	67	5563		2							

### Anschlussgewinde Pg | Entry thread Pg



mit 1 Anschlussgewinde										with 1 entry thread									
G	B/C mm	D mm	F mm	A mm	H mm	I mm	K mm	L mm	M mm	Art.-Nr.   Art. No.									
Pg 9	45 x 48	37	4.3	8	15.5	30	28	10.5	24	5509		10							
Pg 13	53 x 56	44	5.5	8	19.0	35	34	10.5	24	5513		10							
Pg 16	53 x 56	44	5.5	8	19.0	35	34	10.5	24	5516		10							
Pg 21	63 x 65	54	5.5	8	23.0	42	43	11.0	35	5521		10							
Pg 29	71 x 75	60	5.5	10	27.0	52	53	11.0	38	5529		10							
Pg 36	89 x 94	72	6.5	11	34.0	69	65	18.0	50	5536		10							

### Anschlussgewinde Pg | Entry thread Pg

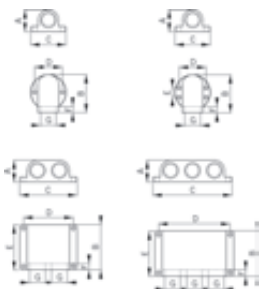

Material: Zinkdruckguss  
 Farbe: Hammerschlaglackiert grau  
 Dichtung: NBR  
 Einsatztemperatur: -40°C / +100°C  
 Schutzart: IP 65  
 Eigenschaften: Für spritzwasserdichte Montage an der Gehäusewandung mit Anschlussgewinde für Kabelverschraubung oder Schlauchverschraubung

Material: Zinc diecasting  
 Colour: Hammergrey enamel  
 Seal: NBR  
 Temperature range: -40°C / +100°C  
 Protection class: IP 65  
 Properties: For splash water-proof mounting on casing walls with entry thread for cable glands or conduit glands



Mit 1 bis 3 Anschlussgewinden										With 1 to 3 entry threads									
G	x	A mm	B mm	C mm	D mm	E mm	F mm	mm	Art.-Nr.   Art. No.										
Pg 16	1 x	31	42	42	36.0	-	11	2x4.5	5516.10		10								
Pg 21	1 x	40	60	60	52.5	-	12	2x5.2	5521.10		10								
Pg 29	1 x	51.5	76	66	54.0	36	12	4x5.5	5529.10		10								
Pg 36	1 x	62	90	85	73.0	30	12	4x5.5	5536.10		10								
Pg 16	2 x	34	70	91	79.0	58	10	4x5.5	5516.12		10								
Pg 16	3 x	34	70	124	111.0	56	10	4x5.5	5516.13		10								

# Universal Kabeleinführung für Flach- und Rundkabel

## Universal cable entry for flat and round cables

Für Flach- und Rundkabel | For flat and round cables

Material: Alu (AlMgSi0.5)  
 Eigenschaften: Universal für ein oder mehrere Kabel, auch mit verschiedenen Abmessungen und Durchmessern. Max. Einbau von Flachkabeln 70x12 mm.  
 Dichtung: NBR  
 Einsatztemperatur: -40°C / +100°C  
 Schutzart: IP 54 - IP 68

Material: Alu (AlMgSi0.5)  
 Properties: Universally applicable for one or several cable(s) with various dimensions and diameters. Max. cable dimension 70x12 mm.  
 Seal: NBR  
 Temperature range: -40°C / +100°C  
 Protection class: IP 54 - IP 68

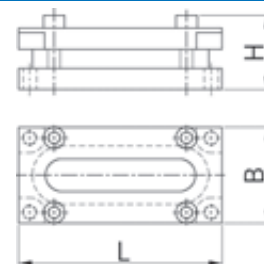

Aluminium Gehäuse zweiteilig  
 Mit Dichtscheibe  
 Universeller Dichtungseinsatz

Two-piece aluminium housing  
 With sealing washer  
 Universal sealing insert

L x B mm	 mm	H mm	Art.-Nr.   Art. No.	
95x45	70.0x12.0	35	1370.15	5
95x45	49.0x4.5	35	1370.15.49.04	5
95x45	2x49.0x4.5	35	1370.15.49.45	5
95x45	63.0x12.0	35	1370.15.63.12	5
95x45	max.70.0x12.0	35	1370.15.30	5

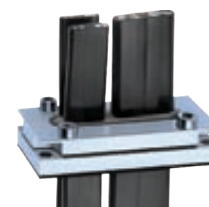

### Technischer Hinweis

Vollgummi-Dichteinsätze auf die entsprechende Kabeldimension aufbohren (Rundkabel Ø +1mm)

Dichteinsätze ohne Bohrung lassen sich gut bearbeiten, wenn sie vorher auf mindestens -25°C heruntergekühlt wurden.

### Technical note

Drill solid rubber inserts to match the appropriate cable diameter (round cables Ø +1 mm)

When frozen to at least -25°C, the solid sealing inserts are easy to drill.

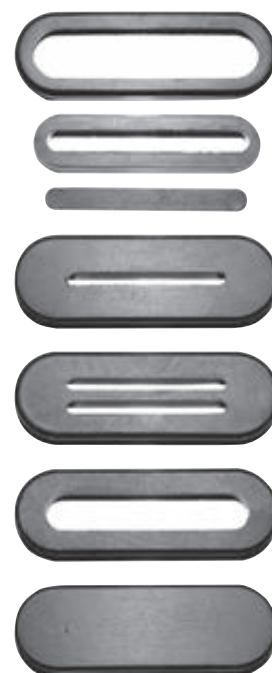
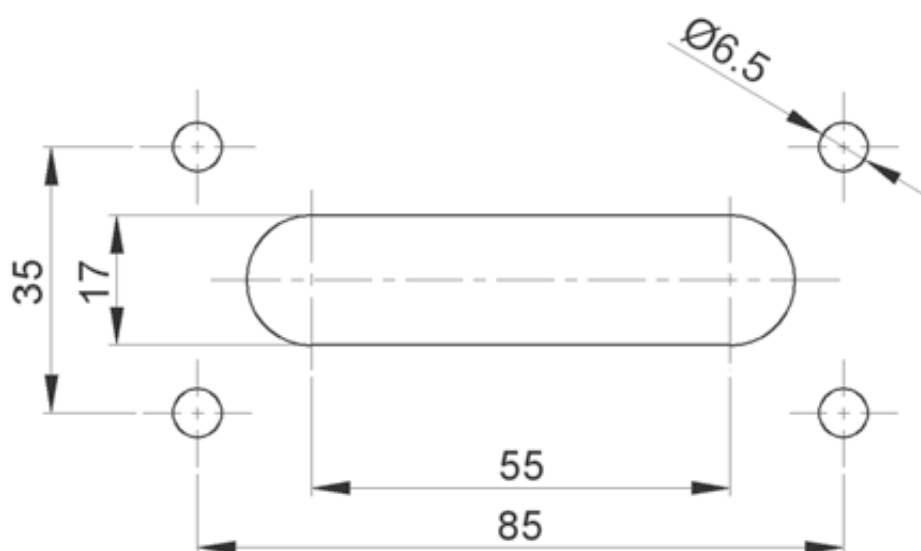

# Stopfbuchsen Messing nach DIN 46320-C4-MS

## Cable glands nickel-plated brass according to DIN 46320-C4-MS

### Kurzes Anschlussgewinde metrisch | Short entry thread metric

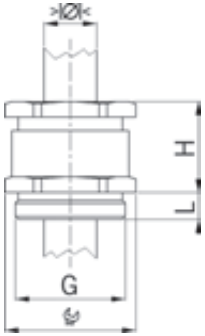

Material: Messing vernickelt  
 Dichtung: NBR  
 Einsatztemperatur: -20°C / +80°C  
 Schutzart: IP 54

Material: Nickel-plated brass  
 Seal: NBR  
 Temperature range: -20°C / +80°C  
 Protection class: IP 54



Einteiliger Einschnittring nicht durchgehend isolierend		One piece sealing ring not overall length insulated				Art.-Nr.   Art. No.	
G	> Ø < min mm	> Ø < max mm	 mm	H mm	L mm		
M12x1.5	5.0	7.0	14/13	15	5	B 112	100
M16x1.5	6.0	8.0	18/15	15	5	B 117	100
M20x1.5	8.0	10.0	22/18	19	6	B 120.10	50
M20x1.5	10.0	12.0	22/20	19	6	B 120.12	50
M20x1.5	12.0	14.0	22/20	19	6	B 120.14	50
M25x1.5	15.0	17.0	30/28	23	7	B 125	50
M32x1.5	24.0	26.0	40/37	26	8	B 132	25
M40x1.5	33.0	35.0	50/47	30	8	B 140	20
M50x1.5	39.0	41.0	57/54	34	9	B 150	10
M63x1.5	45.0	47.0	66/60	35	10	B 163	10

### Langes Anschlussgewinde metrisch | Long entry thread metric



Einteiliger Einschnittring nicht durchgehend isolierend		One piece sealing ring not overall length insulated				Art.-Nr.   Art. No.	
G	> Ø < min mm	> Ø < max mm	 mm	H mm	L mm		
M12x1.5	5.0	7.0	14/13	15	10	B 212	100
M16x1.5	6.0	8.0	18/15	15	10	B 217	100
M20x1.5	8.0	10.0	22/18	19	10	B 220.10	50
M20x1.5	10.0	12.0	22/20	19	10	B 220.12	50
M20x1.5	12.0	14.0	22/20	19	10	B 220.14	50
M25x1.5	15.0	17.0	30/28	23	12	B 225	50
M32x1.5	24.0	26.0	40/37	26	12	B 232	25
M40x1.5	33.0	35.0	50/47	30	14	B 240	20
M50x1.5	39.0	41.0	57/54	34	14	B 250	10
M63x1.5	45.0	47.0	66/60	35	14	B 263	10

# Stopfbuchsen Messing nach DIN 46320-C4-MS

## Cable glands nickel-plated brass according to DIN 46320-C4-MS

### Kurzes Anschlussgewinde Pg | Short entry thread Pg

Material: Messing vernickelt  
 Dichtung: NBR  
 Einsatztemperatur: -20°C / +80°C  
 Schutzart: IP 54

Material: Nickel-plated brass  
 Seal: NBR  
 Temperature range: -20°C / +80°C  
 Protection class: IP 54

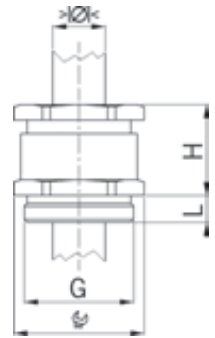

Einteiliger Einschnittring  
 nicht durchgehend isolierend

One piece sealing ring  
 not overall length insulated

G	$\begin{matrix} > \varnothing < \\ \text{min mm} \end{matrix}$	$\begin{matrix} > \varnothing < \\ \text{max mm} \end{matrix}$		H mm	L mm	Art.-Nr.   Art. No.	
Pg 7	6.0	8.0	14/13	15	5	B 107	50
Pg 9	4.0	10.0	17/15	15	5	B 109	50
Pg 11	6.5	12.0	20/18	17	6	B 111	50
Pg 13	6.5	13.5	22/20	20	6	B 113	50
Pg 16	6.5	16.0	24/22	22	6	B 116	50
Pg 21	9.0	20.0	30/28	24	7	B 121	50
Pg 29	17.0	28.0	40/37	26	8	B 129	25
Pg 36	23.0	34.0	50/47	30	9	B 136	10
Pg 42	29.0	40.0	57/54	34	10	B 142	10
Pg 48	35.0	46.0	64/60	37	10	B 148.48	10

### Langes Anschlussgewinde Pg | Long entry thread Pg

Einteiliger Einschnittring  
 nicht durchgehend isolierend

One piece sealing ring  
 not overall length insulated

G	$\begin{matrix} > \varnothing < \\ \text{min mm} \end{matrix}$	$\begin{matrix} > \varnothing < \\ \text{max mm} \end{matrix}$		H mm	L mm	Art.-Nr.   Art. No.	
Pg 9	4.0	10.0	17/15	15	15	B 209	50
Pg 11	6.5	12.0	20/18	17	15	B 211	50
Pg 13	6.5	13.5	22/20	20	15	B 213	50
Pg 16	6.5	16.0	24/22	22	15	B 216	50
Pg 21	9.0	20.0	30/28	24	15	B 221	50
Pg 29	17.0	28.0	40/37	26	15	B 229	25
Pg 36	23.0	34.0	50/47	30	15	B 236	10
Pg 42	29.0	40.0	57/54	34	15	B 242	10
Pg 48	35.0	46.0	64/60	37	15	B 248.48	10





# Stopfbuchsen Messing mit Klemmbacken

## Cable glands nickel-plated brass with clamps

### Kurzes Anschlussgewinde metrisch | Short entry thread metric

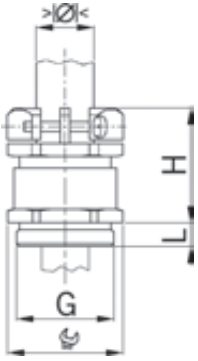



Material: Messing vernickelt  
 Dichtung: NBR  
 Einsatztemperatur: -20°C / +80°C  
 Schutzart: IP 54

Material: Nickel-plated brass  
 Seal: NBR  
 Temperature range: -20°C / +80°C  
 Protection class: IP 54



Einteiliger Einschnittring  
 nicht durchgehend isolierend

One piece sealing ring  
 not overall length insulated



G	> Ø < min mm	> Ø < max mm	 mm	H mm	L mm	Art.-Nr.   Art. No.	
M12x1.5	5.0	7.0	14/17	22	5	1803.12	50
M16x1.5	6.0	8.0	17/20	25	6	1803.17	50
M20x1.5	8.0	10.0	24/27	26	6	1803.20	50
M25x1.5	15.0	17.0	30/35	28	6	1803.25	25
M32x1.5	24.0	26.0	40/43	29	6	1803.32	25
M40x1.5	33.0	35.0	50/55	33	7	1803.40	10

### Kurzes Anschlussgewinde Pg | Short entry thread Pg



Einteiliger Einschnittring  
 nicht durchgehend isolierend

One piece sealing ring  
 not overall length insulated

G	> Ø < min mm	> Ø < max mm	 mm	H mm	L mm	Art.-Nr.   Art. No.	
Pg 7	6.0	8.0	14/16	22	5	1803.07	50
Pg 9	8.0	10.0	17/19	25	6	1803.09	50
Pg 11	10.0	12.0	20/22	26	6	1803.11	50
Pg 13	12.0	14.0	22/24	27.5	6.5	1803.13	50
Pg 16	14.0	16.0	24/27	28.5	6.5	1803.16	50
Pg 21	14.0	16.0	30/34	33	7	1803.21	25
Pg 29	24.0	26.0	40/42	36	8	1803.29	25
Pg 36	30.0	32.0	50/52	41	9	1803.36	10
Pg 42	39.0	41.0	57/59	45	10	1803.42	10
Pg 48	45.0	47.0	64/64	48	10	1803.48.48	10

# Stopfbuchsen Messing mit Trompete und Klemmbacken

## Cable glands nickel-plated brass with trumpet and clamps

### Kurzes Anschlussgewinde metrisch | Short entry thread metric

Material: Messing vernickelt  
 Dichtung: NBR  
 Einsatztemperatur: -20°C / +80°C  
 Schutzart: IP 54

Material: Nickel-plated brass  
 Seal: NBR  
 Temperature range: -20°C / +80°C  
 Protection class: IP 54

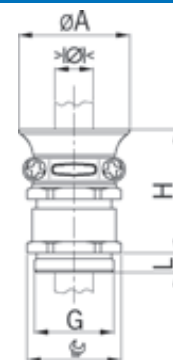

Einteiliger Einschnittring nicht durchgehend isolierend		One piece sealing ring not overall length insulated						Art.-Nr.   Art. No.	
G	>Ø< min mm	>Ø< max mm	 mm	H mm	L mm	ØA mm			
M16x1.5	6.0	8.0	18/17	29	5	22	1801.17	50	
M20x1.5	8.0	10.0	22/20	31	6	26	1801.20.10	50	
M20x1.5	10.0	12.0	22/22	32	6	29	1801.20.12	50	
M20x1.5	12.0	14.0	22/24	34	6	32	1801.20.14	50	
M25x1.5	15.0	17.0	30/30	37	7	38	1801.25	50	
M32x1.5	24.0	26.0	40/41	43	8	50	1801.32	25	



### Kurzes Anschlussgewinde Pg | Short entry thread Pg

Einteiliger Einschnittring nicht durchgehend isolierend		One piece sealing ring not overall length insulated						Art.-Nr.   Art. No.	
G	>Ø< min mm	>Ø< max mm	 mm	H mm	L mm	ØA mm			
Pg 9	6.0	9.0	17	29	6	22	1801.09	50	
Pg 11	8.0	12.0	20	31	6	26	1801.11	50	
Pg 13	9.0	14.0	22	32	6	29	1801.13	50	
Pg 16	10.0	16.0	24	34	6	32	1801.16	50	
Pg 21	14.0	21.0	30	37	7	38	1801.21	50	
Pg 29	18.0	30.0	40	43	8	50	1801.29	25	



# Stopfbuchsen Messing mit Schutztülle und Klemmbacken

## Cable glands nickel-plated brass with antikink nozzle and clamps

### Kurzes Anschlussgewinde metrisch | Short entry thread metric

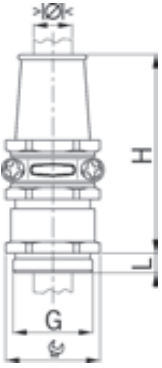



Material: Messing vernickelt  
 Dichtung: NBR  
 Knickschutztülle: NBR  
 Einsatztemperatur: -20°C / +80°C  
 Schutzart: IP 65 wenn Anschlussgewinde abgedichtet

Material: Nickel-plated brass  
 Seal: NBR  
 antikink nozzle: NBR  
 Temperature range: -20°C / +80°C  
 Protection class: IP 65 if the entry thread is sealed



Einteiliger Einschnittring  
 nicht durchgehend isolierend

One piece sealing ring  
 not overall length insulated

G	> Ø < min mm	> Ø < max mm	 mm	H mm	L mm	Art.-Nr.   Art. No.	
M12x1.5	3.5	5.0	14/15	43	5	1852.12.05	25
M16x1.5	5.5	7.0	17/18	44	6	1852.16.07	25
M20x1.5	5.5	7.0	20/22	49	6	1852.20.07	25
M20x1.5	7.5	9.0	20/22	49	6	1852.20.09	25
M20x1.5	9.0	11.0	22/22	54	6	1852.20.11	25
M20x1.5	11.0	13.0	22/22	54	6	1852.20.13	25
M20x1.5	13.0	15.0	24/24	58	6	1852.20.15	25
M25x1.5	13.5	15.0	30/30	71	7	1852.25.15	25
M25x1.5	15.0	17.0	30/30	71	7	1852.25.17	25
M25x1.5	17.0	19.0	30/30	71	7	1852.25.19	25
M25x1.5	18.0	20.0	30/30	71	7	1852.25.20	25
M32x1.5	21.0	23.0	40/40	81	8	1852.32.23	1
M32x1.5	23.0	25.0	40/40	81	8	1852.32.25	1
M40x1.5	23.0	26.0	50/50	99	9	1852.40.26	1
M40x1.5	27.0	30.0	50/50	99	9	1852.40.30	1
M40x1.5	30.0	33.0	50/50	99	9	1852.40.33	1
M40x1.5	32.0	35.0	50/50	99	9	1852.40.35	1

# Stopfbuchsen Messing mit Schutztülle und Klemmbacken

## Cable glands nickel-plated brass with antikink nozzle and clamps

### Kurzes Anschlussgewinde Pg | Short entry thread Pg

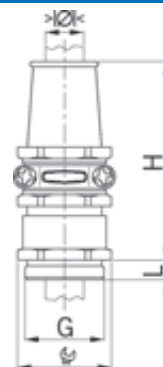

Material: Messing vernickelt  
 Dichtung: NBR  
 Knickschutztülle: NBR  
 Einsatztemperatur: -20°C / +80°C  
 Schutzart: IP 65 wenn Anschlussgewinde abgedichtet

Material: Nickel-plated brass  
 Seal: NBR  
 antikink nozzle: NBR  
 Temperature range: -20°C / +80°C  
 Protection class: IP 65 if the entry thread is sealed



Einteiliger Einschnittring  
 nicht durchgehend isolierend

One piece sealing ring  
 not overall length insulated

G	> Ø < min mm	> Ø < max mm		H mm	L mm	Art.-Nr.   Art. No.	
Pg 7	3.5	5.0	14/16	46	5	1852.07.05	50
Pg 9	5.5	7.0	17/19	45	6	1852.09.07	50
Pg 11	5.5	7.0	20/22	45	6	1852.11.07	50
Pg 11	7.5	9.0	20/22	49	6	1852.11.09	50
Pg 13	7.5	9.0	22/24	54	6	1852.13.09	25
Pg 13	9.0	11.0	22/24	54	6	1852.13.11	25
Pg 13	11.0	13.0	22/24	54	6	1852.13.13	25
Pg 16	11.5	13.0	24/27	58	6	1852.16.13	25
Pg 16	13.0	15.0	24/27	58	6	1852.16.15	25
Pg 21	13.5	15.0	30/34	71	7	1852.21.15	25
Pg 21	15.0	17.0	30/34	71	7	1852.21.17	25
Pg 21	17.0	19.0	30/34	71	7	1852.21.19	25
Pg 21	18.0	20.0	30/34	71	7	1852.21.20	25
Pg 29	18.0	20.0	40/42	71	8	1852.29.20	1
Pg 29	21.0	23.0	40/42	82	8	1852.29.23	1
Pg 29	23.0	25.0	40/42	82	8	1852.29.25	1
Pg 36	23.0	26.0	50/52	101	9	1852.36.26	1
Pg 36	27.0	30.0	50/52	101	9	1852.36.30	1
Pg 36	30.0	33.0	50/52	99	9	1852.36.33	1
Pg 36	32.0	35.0	50/52	99	9	1852.36.35	1
Pg 42	32.0	35.0	57/62	104	10	1852.42.35	1
Pg 42	35.0	38.0	57/62	104	10	1852.42.38	1
Pg 42	36.0	40.0	57/62	104	10	1852.42.40	1
Pg 48	36.0	40.0	64/68	110	10	1852.48.48.40	1
Pg 48	40.0	44.0	64/68	110	10	1852.48.48.44	1





**Die elektromagnetische Verträglichkeit (EMV)** im industriellen Umfeld besitzt einen besonderen Stellenwert, da gerade komplexe Maschinen und Anlagen äußerst anfällig für elektromagnetische Störungen sind. Den unerwünschten EMV-Effekten lässt sich jedoch mit einer wirkungsvollen Schirmung aller Komponenten entgegensteuern. Eine gute Schirmung reduziert einerseits die Störaussendung eines elektrischen Betriebsmittels und verringert gleichzeitig dessen Anfälligkeit für elektromagnetische Beeinträchtigungen.

Allerdings müssen nicht nur die Kabel selbst, sondern auch die restlichen Installationskomponenten einen Schirmcharakter aufweisen. Kabelverschraubungen als passive Bauteile müssen sicherstellen, dass die Qualität der Schirmung an den sensiblen Verbindungsstellen erhalten bleibt und es keine Schirmungsverluste gibt. Insofern ist es notwendig, nicht nur eine maximal geschirmte Leitung zu verwenden, sondern auch EMV-gerechte Kabelverschraubungen einzusetzen. Obwohl für diese Bauteile keine eigenständige EMV-Norm existiert, tragen sie wesentlich dazu bei, dass die vorgeschriebenen EMV-Auflagen der Hersteller erfüllt werden können.

Mit vier unterschiedlichen, EMV-gerechten Kabelverschraubungen bieten wir dem Kunden das passende Produkt und die ideale Kontaktierungsvariante für jeden Anwendungsfall. Bei der Kabelverschraubung Progress® EMV easyCONNECT und neu auch easyCONNECT Multi Messing erfolgt die Kontaktierung über eine innovative Federklammer.

**Alle Produktreihen zeichnen sich durch eine leichte Montage aus.** Das renommierte Schweizer EMV-Labor MONTENA EMC SA bescheinigt den AGRO Kabelverschraubungen außerdem eine niedrige Transferimpedanz und hohe Strombelastbarkeit. Beides sind gängige Gütekriterien für die Qualität einer Schirmung. Um hier Bestwerte zu erzielen, bezieht AGRO den EMV-Spezialisten bei der Entwicklung neuer Produkte schon von Beginn an ein.

**The electromagnetic compatibility (EMC)** in the industrial sector plays a key role because complex machines and systems are extremely susceptible to electromagnetic interference. Such undesired EMC effects, however, can be counteracted with the effective shielding of all components. On the one hand, good shielding reduces the amount of interference emitted by an electrical apparatus while at the same time reducing its susceptibility to impaired performance due to electromagnetic effects.

Not only cables themselves but also all other components that are part of the installation must provide shielding characteristics. As passive components, cable glands must ensure that the quality of the shielding at sensitive interconnection points remains intact and that there are no losses due to the shielding. For this reason, it's necessary to not only use a maximally shielded cable but also add EMC-compliant cable glands. Although there is no separate EMC standard for these components, they play a large contribution towards making it possible to meet the EMC characteristics prescribed by manufacturers.

With four different EMC-compatible cable glands, AGRO offers its customers the appropriate product and the ideal types of contact for each type of application. With the Progress® EMC easyCONNECT and new easyCONNECT Multi brass cable gland, contact is established through an innovative spring clip.

**All these product lines stand out due to their easy assembly.** Furthermore, the renowned Swiss EMC laboratory MONTENA EMC SA has certified AGRO cable glands for lowest transfer impedance and high current carrying capacity. Both are established criteria for the quality of shielding. In order to achieve a top grade, AGRO involves EMC specialists from the very beginning of new-product development.





Kabelverschraubungen Progress® EMV easyCONNECT Messing mit Kontaktfeder Cable glands Progress® EMC easyCONNECT nickel-plated brass with contact spring Kabelverschraubungen Progress® EMV easyCONNECT Multi Messing für mehrere Kabel Cable glands Progress® EMC easyCONNECT nickel-plated brass for several cables		<b>89</b>
Kabelverschraubungen Progress® EMV Rapid Messing mit Kontaktscheibe Cable glands Progress® EMC Rapid nickel-plated brass with contact disc		<b>90 - 91</b>
Kabelverschraubungen Progress® EMV Messing mit Kontakthülse Cable glands Progress® EMC nickel-plated brass with contact sleeve		<b>92 - 95</b>
Kabelverschraubungen Progress® EMV Messing mit Kontakthülse für hohe Temperaturen Cable glands Progress® EMC nickel-plated brass with contact sleeve for high temperature applications		<b>96 - 97</b>
Kabelverschraubungen Progress® EMV Messing mit Knickschutzfeder Cable glands Progress® EMC nickel-plated brass with antikink spring		<b>98 - 99</b>
Kabelverschraubungen Progress® EMV Serie 85 Messing mit Spannzange Cable glands Progress® EMC Series 85 nickel-plated brass with collet chuck		<b>100 - 101</b>
Zubehör zu EMV-Kabelverschraubungen EMC cable glands accessories		<b>102 - 103</b>

- 1
- 2
- 3
- 4**
- 5
- 6
- 7
- 8
- 9
- 10
- 11
- 12

## Vier unterschiedliche Kontaktierungsvarianten Four different types of contact

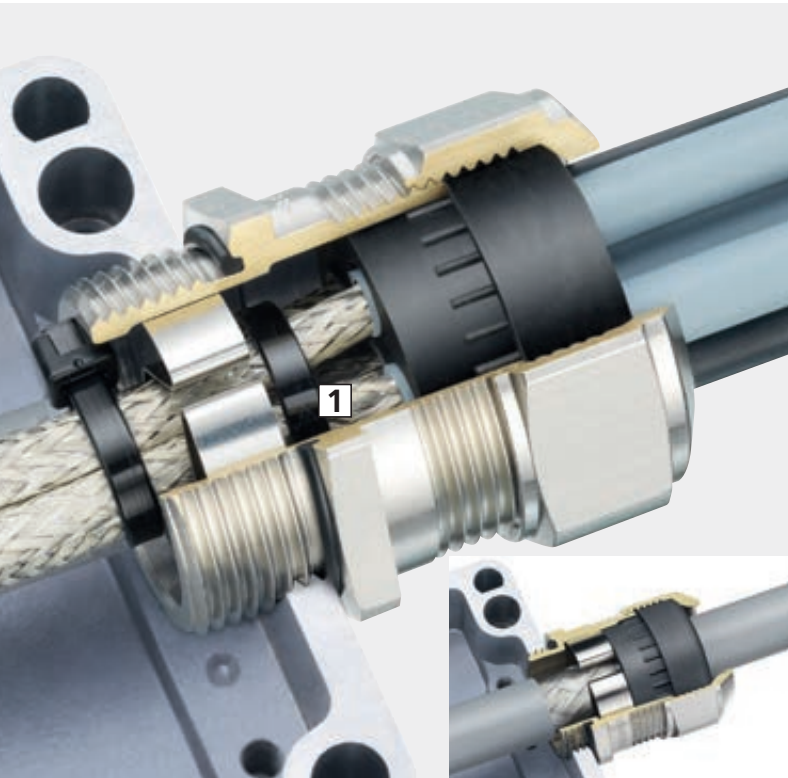

### Progress® EMV easyCONNECT Messing

Die Kabelverschraubung Progress® EMV easyCONNECT gewährleistet die volle Installationskontrolle und gleicht Toleranzen in den Schirmdicken für einen sicheren Schirmabgriff aus. Das Federsystem ermöglicht eine gute und sichere Schirmkontaktierung sowohl bei partiell abisolierten Abschirmkabeln als auch bei vollständig freigelegten Kabelschirmen.

Die Progress® EMV easyCONNECT Multi ist die erste Kabelverschraubung, die das Einführen von mehreren geschirmten Kabeln in ein Gehäuse erlaubt - und dies mit kraftvollem und sicherem Schirmabgriff

#### 1 Optimale Schirmkontaktierung

Die kraftvolle, schonende Klemmung des Kabelschirms garantiert einen hervorragenden Schirmkontakt und sorgt für extrem niedrige Transferimpedanzen. Durch die spezielle Formgebung der Kontaktfeder ist nicht nur ein großer Schirmklemmbereich sondern auch die Demontierbarkeit der Kabelverschraubung ohne Zerstörung des EMV-Geflechtes gegeben.

### Progress® EMC easyCONNECT nickel-plated brass

The cable glands Progress® EMC easyCONNECT guarantees full control during installation and compensates for tolerances in shielding thicknesses to make a secure screened tap connection. The spring system provides for a very good contact of partially stripped shielding cables equally as well as for the contact of completely exposed cable shields which can be routed further.

The Progress® EMC easyCONNECT Multi is the first cable gland that allows for the entry of several shielded cables into a housing - at any moment granting a strong and safe tap connection.

#### 1 Optimal shield contact

The powerful, protective clamping of the cable shield guarantees excellent shield contact and provides for the smallest possible transfer impedance. The shape of the contact spring not only allows for a large clamping range to the shield but also for easy disassembly without damaging the EMC braid.

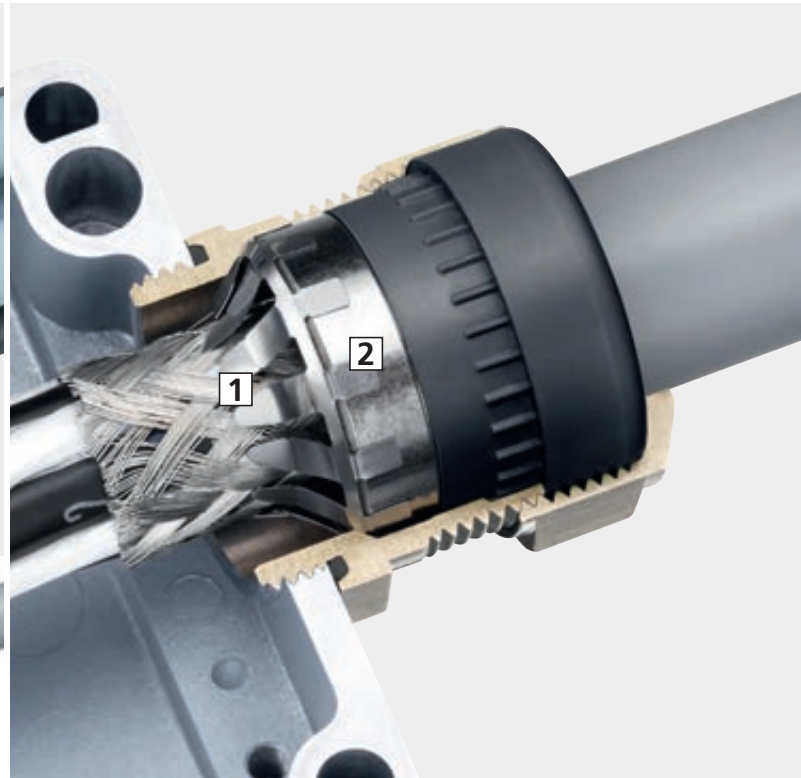

### Progress® EMV Rapid Messing

Die Kabelverschraubung mit den zwei Kontaktierungsvarianten für eine sehr schnelle und einfache Schirmkontaktierung durch eine integrierte Kontaktscheibe. Sie ermöglicht die gute Kontaktierung sowohl von partiell abisolierten Abschirmkabeln als auch von vollständig freigelegten Kabelschirmen, die auch weitergeführt werden können.

#### 1 Niedriger Übergangswiderstand

Die großflächigen, flexiblen Zungen der Kontaktscheibe maximieren die Abgriffsfläche am Schirmgeflecht und erlauben eine zeitsparende Montage.

#### 2 Flexible Kontaktierungsmöglichkeiten

Für eine höherwertige 360° Schirmkontaktierung, kann die Kontaktscheibe ausgestoßen werden und das zugeschnittene Schirmgeflecht über die Kontakthülse direkt mit der Kontaktfläche im Unterteil der Kabelverschraubung kontaktiert werden.

### Progress® EMC Rapid nickel-plated brass

The cable gland with two contact options. An integrated contact disc allows for easy and fast contact to the shield of partially stripped cables as well as of fully stripped cables which shields are being extended.

#### 1 Low contact resistance

The flexible tongues on the contact disc, with their large surface area, maximise the gripping surface on the braided shield.

#### 2 Flexible terminating methods

If a 360° contact is required, the contact disc can be extruded and the trimmed shield can be connected to the contact bushing. The interlocking "sealing insert/contact sleeve" combination ensures that the contact washer continually presses on the bottom part.

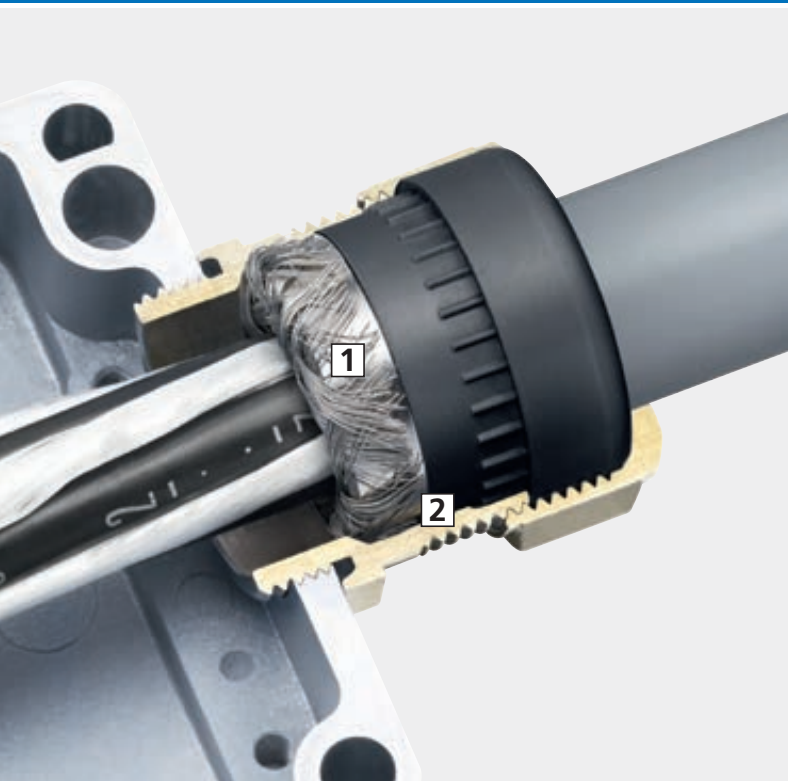

## Progress® EMV Messing

Kabelverschraubungen Progress® EMV aus Messing mit der bewährten Kontakthülse ermöglichen eine Schirmkontaktierung von 360° bei in der Kabelverschraubung endendem Schirmgeflecht. Die maßgebende Kanten-geometrie der Kontakthülse verhindert hierbei ein Abscheren des Schirmgeflechts.

### 1 Kleinste Übergangswiderstände

Der konzentrische Schirmabgriff von 360° bürgt für kleinste Übergangswiderstände.

### 2 Permanenter Kontaktdruck

Die ineinandergreifende Kombination „Dichteinsatz-Kontakthülse“ garantiert einen permanenten Kontaktdruck des Schirmgeflechts am Unterteil.

## Progress® EMC nickel-plated brass

Progress® EMC cable glands made of brass and with the time-proven contact sleeve make 360° contact with braided shield which terminates at the cable gland. The decisive edge geometry of the contact sleeve prevents any shearing of the braided shield.

### 1 Low contact resistance

The immense 360° contact surface ensures low contact resistance.

### 2 Permanent contact pressure

The interlocking “sealing insert/contact sleeve” combination ensures permanent contact pressure of the braided shield against the lower part.

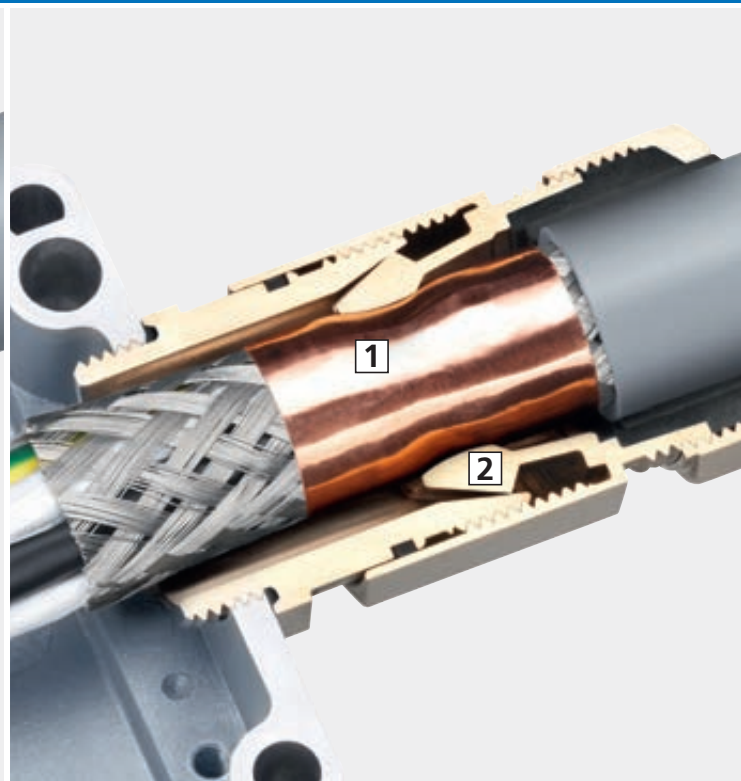

## Progress® EMV Serie 85 Messing

Kabelverschraubungen Progress® EMV Serie 85 aus Messing sorgen für eine besonders niederimpedante Verbindung zwischen Schirmgeflecht und Metallgehäuse bei gleichzeitig sicherer Kabeleinführung.

### 1 Optimale Schirmkontaktierung

Das Zwischenstück mit den großen Schlüsselflächen ermöglicht eine einwandfreie Kontaktierung des Schirmgeflechtes durch die wegverstärkenden Spannzangensegmente über 360°. Das Kupferband sorgt für eine gleichmäßige Kraftverteilung des Schirmgeflechtes.

### 2 Höchste Ableitströme

Die massive Spannzange gewährleistet einen konzentrischen, niederimpedanten Schirmabgriff und bewältigt dauerhaft Ableitströme bis 1.6 kA – kurzzeitig 3 kA.

## Progress® EMC Series 85 nickel-plated brass

Cable glands Progress® EMC Series 85 made of brass provide an especially low-impedance connection between the braided shield and the metal cabinet as well as safe cable entry.

### 1 Optimal shield contact

The connector piece, which is secured with the help of large wrenching surfaces, enables perfect contact of the braided shield by means of a collet chuck with segments that slide together around 360°. The copper tap grants equal transmission of the compression power.

### 2 Highest leakage currents

The massive collet guarantees a concentric, low-impedance screened tap connection and handles leakage currents of up to 1.6 kA continuous – and short term to 3 kA.



	Progress® Messing EMC nickel-plated brass	EMV easyCONNECT EMC easyCONNECT	EMV easyCONNECT Multi EMC easyCONNECT Multi	EMV Rapid EMC Rapid	EMV Standard EMC Standard	EMV Serie 85 EMC Serie 85	EMV mit Knickschutzfeder EMC with anti-kink spring	EMV für Hochtemperatur EMC for high temperatures	EMV Zubehör EMC Accessories	EMV Gegenmutter mit Schneidzähnen EMC locknut with cutting teeth	Erdungsflaschen Grounding strap
<b>Ausführung / Version</b>											
Kompressionstechnik Compression technology		•	•	•	•	•	•	•		-	-
<b>EMV Technik / EMC tapping bonding technology</b>											
Kontaktfeder Contact spring		•	•	-	-	-	A	A		-	-
Kontaktscheibe Contact disc		-	-	•	-	-	A	A		-	-
Kontakthülse Contact sleeve		-	-	•	•	-	•	•		-	-
Spannzange Collet chuck		-	-	-	-	•	-	A		-	-
<b>Gewinde / Thread</b>											
Anschlussgewinde metrisch Entry thread metric		•	•	•	•	•	•	•		•	•
Anschlussgewinde Pg Entry thread Pg		A	A	•	•	•	•	•		•	•
Kurzes Anschlussgewinde (Standard) Short entry thread (standard)		•	•	•	•	•	•	•		-	-
Langes Anschlussgewinde Long entry thread		•	•	•	•	A	A	•		-	-
<b>Dichteinsatz / Sealing ring</b>											
für Rundkabel for round cables		•	•	•	•	•	•	•		-	-
einteiliger Dichteinsatz One-piece sealing insert		A	A	•	•	A	•	•		-	-
zweiteiliger Dichteinsatz Two-piece sealing insert		•	-	-	-	•	-	-		-	-
TPE-Dichteinsatz (Standard) standard sealing insert (TPE)		•	•	•	•	•	•	-		-	-
FPM-Dichteinsatz FPM sealing insert		A	A	A	•	A	A	•		-	-
Dichteinsatz nach EN 45545 Sealing insert according to EN 45545		•	•	•	•	•	•	-		-	-
<b>Anwendung / Characteristics</b>											
Knickschutz Anti-kink protection		-	-	-	-	-	•	-		-	-
Schirmgeflecht wird weitergeführt Continuation of braided shield		•	•	•	-	•	-	-		-	-
Schirmgeflecht wird nicht weitergeführt Without continuation of braided shield		•	•	•	•	•	•	•		-	-
variabler Schirm-Klemmbereich Extent of clamping range for the shield		+++	+++	++	+	+	+	+		-	-
niedrige Transferimpedanz Minimal transfer impedance		++	++	+	++	+++	++	++		-	-
hohe Ableitströme (1.6 kA - 3 kA) High leakage currents		-	-	-	-	+++	-	-		-	-
Demontierbarkeit ohne Beschädigung des Kabelschirms Can be dismantled without damaging the shield		+++	+++	-	+	++	-	-		-	-
Installationsfreundlichkeit (kleiner Zeitaufwand) Easy installation (quick assembly)		++	++	+++	+	+	+	+		-	-

• trifft zu / lieferbar applicable / available    - trifft nicht zu / nicht lieferbar not applicable / not available    +++ hervorragend geeignet very well suited    ++ sehr gut geeignet well suited    + gut geeignet suited    A auf Anfrage upon request



# Kabelverschraubungen Progress® EMV easyCONNECT Messing mit Kontaktfeder

## Cable glands Progress® EMC easyCONNECT nickel-plated brass with contact spring

### Kurzes Anschlussgewinde metrisch | Short entry thread metric

Material: Messing vernickelt  
 Kontaktfeder: Federstahl 1.4310  
 Dichtung: TPE  
 O-Ring : NBR  
 Zugentlastung: Ausführung A  
 Einsatztemperatur: -60°C / +100°C  
 Schutzart: IP 68 (bis 10 bar)  
 Weitere Schutzart: IP 69K  
 Eigenschaften: Für zeitsparende und sichere Montage von partiell abisolierten sowie durchgehend geschirmten Kabeln

Material: Nickel-plated brass  
 Contact spring: Spring steel 1.4310  
 Seal: TPE  
 O-ring : NBR  
 Strain relief: Version A  
 Temperature range: -60°C / +100°C  
 Protection class: IP 68 (up to 10 bar)  
 Further protection: IP 69K  
 Properties: For a quick and safe installation of partially dismantled cables as well as thoroughly shielded cables

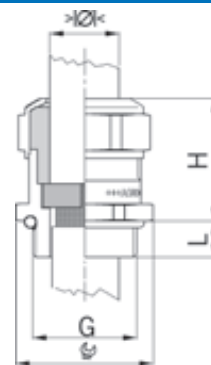

### Progress MS EMV easyCONNECT



Zweiteiliger Dichteinsatz  
 nicht durchgehend isolierend

Two-piece sealing insert  
 not overall length insulated

G	>Ø< min mm	>Ø< max mm		H mm	L mm	i info	Art.-Nr.   Art. No.	
M12x1.5	3.5	5.0	15	22	5	1	1083.12.050	50
M12x1.5	5.0	6.5	15	22	5	1	1083.12.065	50
M16x1.5	6.0	10.5	18	25	5	-	1083.17	50
M20x1.5	8.0	15.0	24	27	6	-	1083.20	50
M25x1.5	12.5	20.5	30	33	7	-	1083.25	25
M32x1.5	17.0	25.5	36	33	8	-	1083.32	25

1 = Einteiliger Dichteinsatz

1 = One-piece sealing insert

Erhältlich mit Dichteinsatz gemäß EN 45545. Bei Anfragen oder Bestellung bitte ein F vor die Artikelnummer setzen.

Available with sealing inserts conformity with EN 45545. When placing an inquiry, prefix the article number by the capital F.



### Langes Anschlussgewinde metrisch | Long entry thread metric

### Progress MS EMV easyCONNECT



Zweiteiliger Dichteinsatz  
 nicht durchgehend isolierend

Two-piece sealing insert  
 not overall length insulated

G	>Ø< min mm	>Ø< max mm		H mm	L mm	i info	Art.-Nr.   Art. No.	
M12x1.5	3.5	5.0	15	22	10	1	1183.12.050	50
M12x1.5	5.0	6.5	15	22	10	1	1183.12.065	50
M16x1.5	6.0	10.5	18	25	10	-	1183.17	50
M20x1.5	8.0	15.0	24	27	10	-	1183.20	50
M25x1.5	12.5	20.5	30	33	11	-	1183.25	25
M32x1.5	17.0	25.5	36	33	13	-	1183.32	25

1 = Einteiliger Dichteinsatz

1 = One-piece sealing insert

Erhältlich mit Dichteinsatz gemäß EN 45545. Bei Anfragen oder Bestellung bitte ein F vor die Artikelnummer setzen.

Available with sealing inserts conformity with EN 45545. When placing an inquiry, prefix the article number by the capital F.



## Kabelverschraubungen Progress® EMV easyCONNECT Multi

### Cable glands Progress® EMC easyCONNECT Multi

Mit Standard Bohrungen | With standard drills

Mit kundenspezifischen Bohrungen | With customised drills



Sie definieren Anzahl und Durchmesser der Kabeleinführungen – wir liefern Ihnen Ihre individuelle EMV Multi Kabelverschraubung. Wir machen kundenspezifische Lösungen möglich.

You define number and diameter of the cable gland – we produce your individual EMC multi cable gland. We realise customised solutions.





# Kabelverschraubungen Progress® EMV Rapid Messing mit Kontaktscheibe

## Cable glands Progress® EMC Rapid nickel-plated brass with contact disc

### Kurzes Anschlussgewinde metrisch | Short entry thread metric

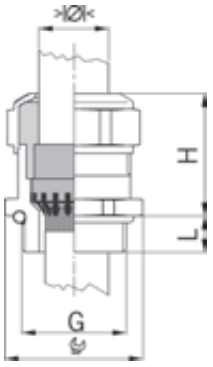

Material: Messing vernickelt  
 Kontakthülse: Messing vernickelt  
 Kontaktscheibe: Rostfreier Stahl A2  
 Dichtung: TPE  
 O-Ring : NBR  
 Zugentlastung: Ausführung A  
 Einsatztemperatur: -40°C / +100°C  
 Schutzart: IP 68 (bis 10 bar)  
 Weitere Schutzart: IP 69K  
 Eigenschaften: Für zeitsparende Montage von partiell abisolierten sowie durchgehend geschirmten Kabeln

Material: Nickel-plated brass  
 Contact sleeve: Nickel-plated brass  
 Contact disc: Stainless steel A2  
 Seal: TPE  
 O-ring : NBR  
 Strain relief: Version A  
 Temperature range: -40°C / +100°C  
 Protection class: IP 68 (up to 10 bar)  
 Further protection: IP 69K  
 Properties: For a quick installation of partially dismantled cables as well as thoroughly shielded cables



#### Progress MS EMC Rapid

Einteiliger Dichteinsatz  
 nicht durchgehend isolierend

One-piece sealing insert  
 not overall length insulated

G	> Ø < min mm	> Ø < max mm	 mm	H mm	L mm	Art.-Nr.   Art. No.	
M12x1.5	4.5	6.0	15	20	5	1081.12.060	50
M12x1.5	6.0	7.5	15	20	5	1081.12.075	50
M16x1.5	6.0	8.0	18	23	5	1081.17.080	50
M16x1.5	8.0	10.0	18	25	5	1081.17.100	50
M20x1.5	8.0	11.0	24	25	6	1081.20.110	50
M20x1.5	11.0	14.0	24	27	6	1081.20.140	50
M25x1.5	13.0	16.0	30	30	7	1081.25.160	25
M25x1.5	16.0	19.0	30	33	7	1081.25.190	25
M32x1.5	18.0	21.0	36	32	8	1081.32.210	25
M32x1.5	21.0	25.0	36	32	8	1081.32.250	25

### Langes Anschlussgewinde metrisch | Long entry thread metric



#### Progress MS EMC Rapid

Einteiliger Dichteinsatz  
 nicht durchgehend isolierend

One-piece sealing insert  
 not overall length insulated

G	> Ø < min mm	> Ø < max mm	 mm	H mm	L mm	Art.-Nr.   Art. No.	
M12x1.5	4.5	6.0	15	20	10	1181.12.060	50
M12x1.5	6.0	7.5	15	20	10	1181.12.075	50
M16x1.5	6.0	8.0	18	23	10	1181.17.080	50
M16x1.5	8.0	10.0	18	25	10	1181.17.100	50
M20x1.5	8.0	11.0	24	25	10	1181.20.110	50
M20x1.5	11.0	14.0	24	27	10	1181.20.140	50
M25x1.5	13.0	16.0	30	30	11	1181.25.160	25
M25x1.5	16.0	19.0	30	33	11	1181.25.190	25
M32x1.5	18.0	21.0	36	32	13	1181.32.210	25
M32x1.5	21.0	25.0	36	32	13	1181.32.250	25

# Kabelverschraubungen Progress® EMV Rapid Messing mit Kontaktscheibe

## Cable glands Progress® EMC Rapid nickel-plated brass with contact disc

### Kurzes Anschlussgewinde Pg | Short entry thread Pg

Material: Messing vernickelt  
 Kontakthülse: Messing vernickelt  
 Kontaktscheibe: Rostfreier Stahl A2  
 Dichtung: TPE  
 O-Ring : NBR  
 Einsatztemperatur: -40°C / +100°C  
 Schutzart: IP 68 (bis 10 bar)  
 Weitere Schutzart: IP 69K  
 Eigenschaften: Für zeitsparende Montage von partiell abisolierten sowie durchgehend geschirmten Kabeln

Material: Nickel-plated brass  
 Contact sleeve: Nickel-plated brass  
 Contact disc: Stainless steel A2  
 Seal: TPE  
 O-ring : NBR  
 Temperature range: -40°C / +100°C  
 Protection class: IP 68 (up to 10 bar)  
 Further protection: IP 69K  
 Properties: For a quick installation of partially dismantled cables as well as thoroughly shielded cables

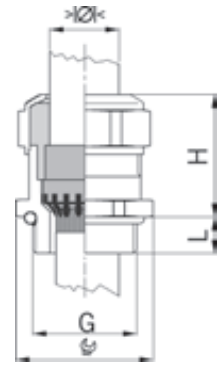

### Progress MS EMC Rapid



Einteiliger Dichteinsatz  
 nicht durchgehend isolierend

One-piece sealing insert  
 not overall length insulated

G	>10< min mm	>10< max mm		H mm	L mm	Art.-Nr.   Art. No.	
Pg 7	4.5	6.0	15	20	6	1081.07.060	50
Pg 7	6.0	7.5	15	20	6	1081.07.075	50
Pg 9	6.0	8.0	18	23	6	1081.09.080	50
Pg 9	8.0	10.0	18	25	6	1081.09.100	50
Pg 11	5.5	8.5	21	25	6	1081.11.085	50
Pg 11	8.5	12.0	21	25	6	1081.11.120	50
Pg 13	8.0	11.0	24	25	6	1081.13.110	50
Pg 13	11.0	14.0	24	27	6	1081.13.140	50
Pg 16	8.0	11.0	24	24	6	1081.16.110	50
Pg 16	11.0	14.0	24	27	6	1081.16.140	50
Pg 21	13.0	16.0	30	30	7	1081.21.160	25
Pg 21	16.0	19.0	30	33	7	1081.21.190	25
Pg 29	19.0	23.0	38	33	8	1081.29.230	25
Pg 29	23.0	25.5	38	32	8	1081.29.255	25



### Langes Anschlussgewinde Pg | Long entry thread Pg

### Progress MS EMC Rapid



Einteiliger Dichteinsatz  
 nicht durchgehend isolierend

One-piece sealing insert  
 not overall length insulated

G	>10< min mm	>10< max mm		H mm	L mm	Art.-Nr.   Art. No.	
Pg 7	4.5	6.0	15	20	10	1181.07.060	50
Pg 7	6.0	7.5	15	20	10	1181.07.075	50
Pg 9	6.0	8.0	18	23	10	1181.09.080	50
Pg 9	8.0	10.0	18	25	10	1181.09.100	50
Pg 11	5.5	8.5	21	25	10	1181.11.085	50
Pg 11	8.5	12.0	21	25	10	1181.11.120	50
Pg 13	8.0	11.0	24	25	10	1181.13.110	50
Pg 13	11.0	14.0	24	27	10	1181.13.140	50
Pg 16	8.0	11.0	24	24	10	1181.16.110	50
Pg 16	11.0	14.0	24	27	10	1181.16.140	50
Pg 21	13.0	16.0	30	30	12	1181.21.160	25
Pg 21	16.0	19.0	30	33	12	1181.21.190	25
Pg 29	19.0	23.0	38	33	12	1181.29.230	25
Pg 29	23.0	25.5	38	32	12	1181.29.255	25



# Kabelverschraubungen Progress® EMV Messing mit Kontakthülse

## Cable glands Progress® EMC nickel-plated brass with contact sleeve

### Kurzes Anschlussgewinde metrisch | Short entry thread metric

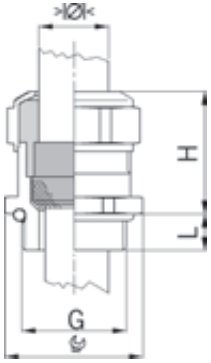

Material: Messing vernickelt  
 Kontakthülse: Messing vernickelt  
 Dichtung: TPE  
 O-Ring : NBR  
 Zugentlastung: Ausführung A  
 Einsatztemperatur: -40°C / +100°C  
 Schutzart: IP 68 (bis 10 bar)  
 Weitere Schutzart: IP 69K  
 Eigenschaften: Sehr guter Schirmkontakt über die Kontakthülse bei in der Kabelverschraubung endendem Schirmgeflecht

Material: Nickel-plated brass  
 Contact sleeve: Nickel-plated brass  
 Seal: TPE  
 O-ring : NBR  
 Strain relief: Version A  
 Temperature range: -40°C / +100°C  
 Protection class: IP 68 (up to 10 bar)  
 Further protection: IP 69K  
 Properties: Excellent shield contact through the contact sleeve with the braided shield terminating in the screwed cable gland

### Progress MS EMC



Einteiliger Dichteinsatz  
 nicht durchgehend isolierend

One-piece sealing insert  
 not overall length insulated

G	>Ø< min mm	>Ø< max mm	EMC	H mm	L mm	i info	Art.-Nr.   Art. No.	
M8x1.25	2.5	3.5	11	15	5	1	1080.08.035	50
M8x1.25	3.0	4.0	11	15	5	1	1080.08.040	50
M10x1.5	3.0	4.0	13	16	5	1	1080.10.040	50
M10x1.5	4.0	6.0	13	16	5	1	1080.10.060	50
M12x1.5	4.5	6.0	15	20	5	-	1080.12.060	50
M12x1.5	6.0	7.5	15	20	5	-	1080.12.075	50
M16x1.5	6.0	8.0	18	23	5	-	1080.17.080	50
M16x1.5	8.0	10.0	18	25	5	-	1080.17.100	50
M20x1.5	8.0	11.0	24	25	6	-	1080.20.110	50
M20x1.5	11.0	14.0	24	27	6	-	1080.20.140	50
M25x1.5	13.0	16.0	30	30	7	-	1080.25.160	25
M25x1.5	16.0	19.0	30	33	7	-	1080.25.190	25
M32x1.5	18.0	21.0	36	32	8	-	1080.32.210	25
M32x1.5	21.0	25.0	36	32	8	-	1080.32.250	25
M40x1.5	24.0	28.5	46	34	8	-	1080.40.285	10
M40x1.5	28.5	32.0	46	34	8	-	1080.40.320	10
M50x1.5	33.0	37.0	55	36	9	-	1080.50.370	10
M50x1.5	37.0	41.0	55	36	9	-	1080.50.410	10
M63x1.5	40.0	46.0	70	39	10	-	1080.63.460	5
M63x1.5	46.0	50.0	70	39	10	-	1080.63.500	5
M75x1.5	50.0	56.0	80	40	11	-	1080.75.560	1
M80x2.0	56.0	65.0	95	45	18	-	1080.80.650	1
M85x2.0	63.0	70.0	95	45	18	-	1080.85.700	1
M95x2.0	68.0	75.0	110	52	20	-	1080.95.750	1

1 = Metrisches Regelgewinde

1 = Metric coarse-pitch thread

Erhältlich mit Dichteinsatz gemäß EN 45545. Bei Anfragen oder Bestellung bitte ein F vor die Artikelnummer setzen.

Available with sealing inserts conformity with EN 45545. When placing an inquiry, prefix the article number by the capital F.

# Kabelverschraubungen Progress® EMV Messing mit Kontakthülse

## Cable glands Progress® EMC nickel-plated brass with contact sleeve

Langes Anschlussgewinde metrisch | Long entry thread metric

Material: Messing vernickelt  
 Kontakthülse: Messing vernickelt  
 Dichtung: TPE  
 O-Ring : NBR  
 Zugentlastung: Ausführung A  
 Einsatztemperatur: -40°C / +100°C  
 Schutzart: IP 68 (bis 10 bar)  
 Weitere Schutzart: IP 69K  
 Eigenschaften: Sehr guter Schirmkontakt über die Kontakthülse bei in der Kabelverschraubung endendem Schirmgeflecht

Material: Nickel-plated brass  
 Contact sleeve: Nickel-plated brass  
 Seal: TPE  
 O-ring : NBR  
 Strain relief: Version A  
 Temperature range: -40°C / +100°C  
 Protection class: IP 68 (up to 10 bar)  
 Further protection: IP 69K  
 Properties: Excellent shield contact through the contact sleeve with the braided shield terminating in the screwed cable gland

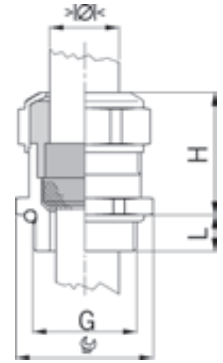

### Progress MS EMC



Einteiliger Dichteinsatz  
 nicht durchgehend isolierend

One-piece sealing insert  
 not overall length insulated

G	>Ø< min mm	>Ø< max mm	EMC	H mm	L mm	i info	Art.-Nr.   Art. No.	
M8x1.25	2.5	3.5	11	15	10	1	1180.08.035	50
M8x1.25	3.0	4.0	11	15	10	1	1180.08.040	50
M10x1.5	3.0	4.0	13	16	10	1	1180.10.040	50
M10x1.5	4.0	6.0	13	16	10	1	1180.10.060	50
M12x1.5	4.5	6.0	15	20	10	-	1180.12.060	50
M12x1.5	6.0	7.5	15	20	10	-	1180.12.075	50
M16x1.5	6.0	8.0	18	23	10	-	1180.17.080	50
M16x1.5	8.0	10.0	18	25	10	-	1180.17.100	50
M20x1.5	8.0	11.0	24	25	10	-	1180.20.110	50
M20x1.5	11.0	14.0	24	27	10	-	1180.20.140	50
M25x1.5	13.0	16.0	30	30	11	-	1180.25.160	25
M25x1.5	16.0	19.0	30	33	11	-	1180.25.190	25
M32x1.5	18.0	21.0	36	32	13	-	1180.32.210	25
M32x1.5	21.0	25.0	36	32	13	-	1180.32.250	25
M40x1.5	24.0	28.5	46	34	13	-	1180.40.285	10
M40x1.5	28.5	32.0	46	34	13	-	1180.40.320	10
M50x1.5	33.0	37.0	55	36	14	-	1180.50.370	10
M50x1.5	37.0	41.0	55	36	14	-	1180.50.410	10
M63x1.5	40.0	46.0	70	39	14	-	1180.63.460	5
M63x1.5	46.0	50.0	70	39	14	-	1180.63.500	5



1 = Metrisches Regelgewinde

1 = Metric coarse-pitch thread

Erhältlich mit Dichteinsatz gemäß EN 45545. Bei Anfragen oder Bestellung bitte ein F vor die Artikelnummer setzen.

Available with sealing inserts conformity with EN 45545. When placing an inquiry, prefix the article number by the capital F.

# Kabelverschraubungen Progress® EMV Messing mit Kontakthülse

## Cable glands Progress® EMC nickel-plated brass with contact sleeve

### Kurzes Anschlussgewinde Pg | Short entry thread Pg

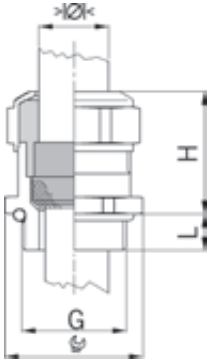

Material: Messing vernickelt  
 Kontakthülse: Messing vernickelt  
 Dichtung: TPE  
 O-Ring : NBR  
 Einsatztemperatur: -40°C / +100°C  
 Schutzart: IP 68 (bis 10 bar)  
 Weitere Schutzart: IP 69K  
 Eigenschaften: Sehr guter Schirmkontakt über die Kontakthülse bei in der Kabelverschraubung endendem Schirmgeflecht

Material: Nickel-plated brass  
 Contact sleeve: Nickel-plated brass  
 Seal: TPE  
 O-ring : NBR  
 Temperature range: -40°C / +100°C  
 Protection class: IP 68 (up to 10 bar)  
 Further protection: IP 69K  
 Properties: Excellent shield contact through the contact sleeve with the braided shield terminating in the screwed cable gland





### Progress MS EMC



Einteiliger Dichteinsatz  
 nicht durchgehend isolierend

One-piece sealing insert  
 not overall length insulated

G	>Ø< min mm	>Ø< max mm	 mm	H mm	L mm	Art.-Nr.   Art. No.	
Pg 7	4.5	6.0	15	20	6	1080.07.060	50
Pg 7	6.0	7.5	15	20	6	1080.07.075	50
Pg 9	6.0	8.0	18	23	6	1080.09.080	50
Pg 9	8.0	10.0	18	25	6	1080.09.100	50
Pg 11	5.5	8.5	21	23	6	1080.11.085	50
Pg 11	8.5	12.0	21	23	6	1080.11.120	50
Pg 13	8.0	11.0	24	25	6	1080.13.110	50
Pg 13	11.0	14.0	24	27	6	1080.13.140	50
Pg 16	8.0	11.0	24	24	6	1080.16.110	50
Pg 16	11.0	14.0	24	27	6	1080.16.140	50
Pg 21	13.0	16.0	30	30	7.5	1080.21.160	25
Pg 21	16.0	19.0	30	33	7.5	1080.21.190	25
Pg 29	19.0	23.0	38	33	8	1080.29.230	25
Pg 29	23.0	25.5	38	32	8	1080.29.255	25
Pg 36	25.0	30.5	50	36	8	1080.36.305	10
Pg 36	30.5	35.0	50	34	8	1080.36.350	10
Pg 42	33.0	37.0	55	37	10	1080.42.370	10
Pg 42	37.0	41.0	55	36	10	1080.42.410	10
Pg 48	39.0	43.0	65	42	11	1080.48.430	10
Pg 48	43.0	46.5	65	40	11	1080.48.465	10

Erhältlich mit Dichteinsatz gemäß EN 45545. Bei Anfragen oder Bestellung bitte ein F vor die Artikelnummer setzen.

Available with sealing inserts conformity with EN 45545. When placing an inquiry, prefix the article number by the capital F.

# Kabelverschraubungen Progress® EMV Messing mit Kontakthülse

## Cable glands Progress® EMC nickel-plated brass with contact sleeve

Langes Anschlussgewinde Pg | Long entry thread Pg

Material: Messing vernickelt  
 Kontakthülse: Messing vernickelt  
 Dichtung: TPE  
 O-Ring : NBR  
 Einsatztemperatur: -40°C / +100°C  
 Schutzart: IP 68 (bis 10 bar)  
 Weitere Schutzart: IP 69K  
 Eigenschaften: Sehr guter Schirmkontakt über die Kontakthülse bei in der Kabelverschraubung endendem Schirmgeflecht

Material: Nickel-plated brass  
 Contact sleeve: Nickel-plated brass  
 Seal: TPE  
 O-ring : NBR  
 Temperature range: -40°C / +100°C  
 Protection class: IP 68 (up to 10 bar)  
 Further protection: IP 69K  
 Properties: Excellent shield contact through the contact sleeve with the braided shield terminating in the screwed cable gland

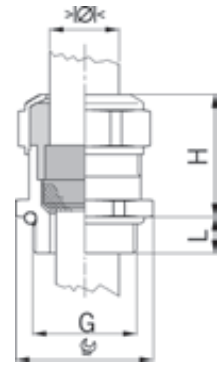

### Progress MS EMC



Einteiliger Dichteinsatz  
 nicht durchgehend isolierend

One-piece sealing insert  
 not overall length insulated

G	>Ø< min mm	>Ø< max mm		H mm	L mm	Art.-Nr.   Art. No.	
Pg 7	4.5	6.0	15	20	10	1180.07.060	50
Pg 7	6.0	7.5	15	20	10	1180.07.075	50
Pg 9	6.0	8.0	18	23	10	1180.09.080	50
Pg 9	8.0	10.0	18	25	10	1180.09.100	50
Pg 11	5.5	8.5	21	23	10	1180.11.085	50
Pg 11	8.5	12.0	21	23	10	1180.11.120	50
Pg 13	8.0	11.0	24	25	10	1180.13.110	50
Pg 13	11.0	14.0	24	27	10	1180.13.140	50
Pg 16	8.0	11.0	24	24	10	1180.16.110	50
Pg 16	11.0	14.0	24	27	10	1180.16.140	50
Pg 21	13.0	16.0	30	30	12	1180.21.160	25
Pg 21	16.0	19.0	30	33	12	1180.21.190	25
Pg 29	19.0	23.0	38	33	12	1180.29.230	25
Pg 29	23.0	25.5	38	32	12	1180.29.255	25
Pg 36	25.0	30.5	50	36	15	1180.36.305	10
Pg 36	30.5	35.0	50	34	15	1180.36.350	10
Pg 42	33.0	37.0	55	37	15	1180.42.370	10
Pg 42	37.0	41.0	55	36	15	1180.42.410	10
Pg 48	39.0	43.0	65	42	15	1180.48.430	10
Pg 48	43.0	46.5	65	40	15	1180.48.465	10

Erhältlich mit Dichteinsatz gemäß EN 45545. Bei Anfragen oder Bestellung bitte ein F vor die Artikelnummer setzen.

Available with sealing inserts conformity with EN 45545. When placing an inquiry, prefix the article number by the capital F.





### Kurzes Anschlussgewinde metrisch | Short entry thread metric

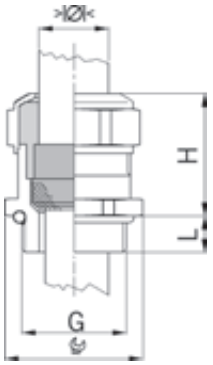

Material: Messing vernickelt  
 Kontakthülse: Messing vernickelt  
 Dichtung: FPM  
 O-Ring : FPM  
 Zugentlastung: Ausführung A  
 Einsatztemperatur: -40°C / +200°C  
 Schutzart: IP 68 (bis 10 bar)  
 Weitere Schutzart: IP 69K  
 Eigenschaften: Sehr guter Schirmkontakt über die Kontakthülse bei in der Kabelverschraubung endendem Schirmgeflecht

Material: Nickel-plated brass  
 Contact sleeve: Nickel-plated brass  
 Seal: FPM  
 O-ring : FPM  
 Strain relief: Version A  
 Temperature range: -40°C / +200°C  
 Protection class: IP 68 (up to 10 bar)  
 Further protection: IP 69K  
 Properties: Excellent shield contact through the contact sleeve with the braided shield terminating in the screwed cable gland



Einteiliger Dichteinsatz  
 nicht durchgehend isolierend

One-piece sealing insert  
 not overall length insulated

G	>Ø< min mm	>Ø< max mm	mm	H mm	L mm	i info	Art.-Nr.   Art. No.	
M10x1.5	3.0	4.0	13	16	5	1	1080.10.91.040	50
M10x1.5	4.0	6.0	13	16	5	1	1080.10.91.060	50
M12x1.5	4.5	6.0	15	20	5	-	1080.12.91.060	50
M12x1.5	6.0	7.5	15	20	5	-	1080.12.91.075	50
M16x1.5	6.0	8.0	18	23	5	-	1080.17.91.080	50
M16x1.5	8.0	10.0	18	25	5	-	1080.17.91.100	50
M20x1.5	8.0	11.0	24	25	6	-	1080.20.91.110	50
M20x1.5	11.0	14.0	24	27	6	-	1080.20.91.140	50
M25x1.5	13.0	16.0	30	30	7	-	1080.25.91.160	25
M25x1.5	16.0	19.0	30	33	7	-	1080.25.91.190	25
M32x1.5	18.0	21.0	36	32	8	-	1080.32.91.210	25
M32x1.5	21.0	25.0	36	32	8	-	1080.32.91.250	25

1 = Metrisches Regelgewinde

1 = Metric coarse-pitch thread

### Langes Anschlussgewinde metrisch | Long entry thread metric



Einteiliger Dichteinsatz  
 nicht durchgehend isolierend

One-piece sealing insert  
 not overall length insulated

G	>Ø< min mm	>Ø< max mm	mm	H mm	L mm	i info	Art.-Nr.   Art. No.	
M10x1.5	3.0	4.0	13	16	10	1	1180.10.91.040	50
M10x1.5	4.0	6.0	13	16	10	1	1180.10.91.060	50
M12x1.5	4.5	6.0	15	20	10	-	1180.12.91.060	50
M12x1.5	6.0	7.5	15	20	10	-	1180.12.91.075	50
M16x1.5	6.0	8.0	18	23	10	-	1180.17.91.080	50
M16x1.5	8.0	10.0	18	25	10	-	1180.17.91.100	50
M20x1.5	8.0	11.0	24	25	10	-	1180.20.91.110	50
M20x1.5	11.0	14.0	24	27	10	-	1180.20.91.140	50
M25x1.5	13.0	16.0	30	30	11	-	1180.25.91.160	25
M25x1.5	16.0	19.0	30	33	11	-	1180.25.91.190	25
M32x1.5	18.0	21.0	36	32	13	-	1180.32.91.210	25
M32x1.5	21.0	25.0	36	32	13	-	1180.32.91.250	25

1 = Metrisches Regelgewinde

1 = Metric coarse-pitch thread



Kurzes Anschlussgewinde Pg | Short entry thread Pg

Material: Messing vernickelt  
 Kontakthülse: Messing vernickelt  
 Dichtung: FPM  
 O-Ring : FPM  
 Einsatztemperatur: -40°C / +200°C  
 Schutzart: IP 68 (bis 10 bar)  
 Weitere Schutzart: IP 69K  
 Eigenschaften: Sehr guter Schirmkontakt über die Kontakthülse bei in der Kabelverschraubung endendem Schirmgeflecht

Material: Nickel-plated brass  
 Contact sleeve: Nickel-plated brass  
 Seal: FPM  
 O-ring : FPM  
 Temperature range: -40°C / +200°C  
 Protection class: IP 68 (up to 10 bar)  
 Further protection: IP 69K  
 Properties: Excellent shield contact through the contact sleeve with the braided shield terminating in the screwed cable gland

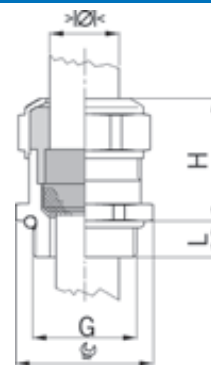

Einteiliger Dichteinsatz nicht durchgehend isolierend						One-piece sealing insert not overall length insulated	
G	> Ø < min mm	> Ø < max mm		H mm	L mm	Art.-Nr.   Art. No.	
Pg 9	6.0	8.0	18	23	6	1080.09.91.080	50
Pg 9	8.0	10.0	18	25	6	1080.09.91.100	50
Pg 11	5.5	8.5	21	23	6	1080.11.91.085	50
Pg 11	8.5	12.0	21	23	6	1080.11.91.120	50
Pg 13	8.0	11.0	24	25	6	1080.13.91.110	50
Pg 13	11.0	14.0	24	27	6	1080.13.91.140	50
Pg 16	8.0	11.0	24	24	6	1080.16.91.110	50
Pg 16	11.0	14.0	24	27	6	1080.16.91.140	50
Pg 21	13.0	16.0	30	30	7.5	1080.21.91.160	25
Pg 21	16.0	19.0	30	33	7.5	1080.21.91.190	25
Pg 29	19.0	23.0	38	33	8	1080.29.91.230	25
Pg 29	23.0	25.5	38	32	8	1080.29.91.255	25



Langes Anschlussgewinde Pg | Long entry thread Pg

Einteiliger Dichteinsatz nicht durchgehend isolierend						One-piece sealing insert not overall length insulated	
G	> Ø < min mm	> Ø < max mm		H mm	L mm	Art.-Nr.   Art. No.	
Pg 9	6.0	8.0	18	23	10	1180.09.91.080	50
Pg 9	8.0	10.0	18	25	10	1180.09.91.100	50
Pg 11	5.5	8.5	21	23	10	1180.11.91.085	50
Pg 11	8.5	12.0	21	23	10	1180.11.91.120	50
Pg 13	8.0	11.0	24	25	10	1180.13.91.110	50
Pg 13	8.5	12.0	24	27	10	1180.13.91.140	50
Pg 16	8.0	11.0	24	24	10	1180.16.91.110	50
Pg 16	11.0	14.0	24	27	10	1180.16.91.140	50
Pg 21	13.0	16.0	30	30	12	1180.21.91.160	25
Pg 21	16.0	19.0	30	33	12	1180.21.91.190	25
Pg 29	19.0	23.0	38	33	12	1180.29.91.230	25
Pg 29	23.0	25.5	38	32	12	1180.29.91.255	25



# Kabelverschraubungen Progress® EMV Messing mit Knickschutzfeder

## Cable glands Progress® EMC nickel-plated brass with antikink spring

### Kurzes Anschlussgewinde metrisch | Short entry thread metric

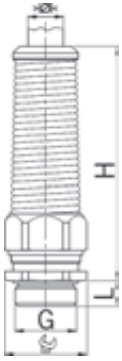

Material: Messing vernickelt  
 Knickschutzfeder: Rostfreier Stahl A2  
 Dichtung: TPE  
 O-Ring : NBR  
 Zugentlastung: Ausführung A  
 Einsatztemperatur: -40°C / +100°C  
 Schutzart: IP 68  
 Weitere Schutzart: IP 69K  
 Eigenschaften: Sehr guter Schirmkontakt über die Kontakthülse bei in der Kabelverschraubung endendem Schirmgeflecht

Material: Nickel-plated brass  
 Antikink spring: Stainless steel A2  
 Seal: TPE  
 O-ring : NBR  
 Strain relief: Version A  
 Temperature range: -40°C / +100°C  
 Protection class: IP 68  
 Further protection: IP 69K  
 Properties: Excellent shield contact through the contact sleeve with the braided shield terminating in the screwed cable gland

### Progress MS EMC FKN



Einteiliger Dichteinsatz  
 nicht durchgehend isolierend

One-piece sealing insert  
 not overall length insulated

G	> Ø < min mm	> Ø < max mm	 mm	H mm	L mm	i info	Art.-Nr.   Art. No.	
M8x1.25	2.5	3.5	11	50	5	1	1080.08.52.035	10
M8x1.25	3.0	4.0	11	50	5	1	1080.08.52.040	10
M10x1.5	3.0	4.0	13	54	5	1	1080.10.52.040	10
M10x1.5	4.0	6.0	13	54	5	1	1080.10.52.060	10
M12x1.5	4.5	6.0	15	60	5	-	1080.12.52.060	10
M12x1.5	6.0	7.5	15	60	5	-	1080.12.52.075	10
M16x1.5	6.0	8.0	18	69	5	-	1080.17.52.080	10
M16x1.5	8.0	10.0	18	69	5	-	1080.17.52.100	10
M20x1.5	8.0	11.0	24	88	6	-	1080.20.52.110	10
M20x1.5	11.0	14.0	24	88	6	-	1080.20.52.140	10
M25x1.5	13.0	16.0	30	104	7	-	1080.25.52.160	10
M25x1.5	16.0	19.0	30	104	7	-	1080.25.52.190	10
M32x1.5	18.0	21.0	36	112	8	-	1080.32.52.210	5
M32x1.5	21.0	24.5	36	112	8	-	1080.32.52.245	5

1 = Metrisches Regelgewinde

1 = Metric coarse-pitch thread

Erhältlich mit Dichteinsatz gemäß EN 45545. Bei Anfragen oder Bestellung bitte ein F vor die Artikelnummer setzen.

Available with sealing inserts conformity with EN 45545. When placing an inquiry, prefix the article number by the capital F.

Langes Anschlussgewinde auf Anfrage

Long entry thread available on request

# Kabelverschraubungen Progress® EMV Messing mit Knickschutzfeder Cable glands Progress® EMC nickel-plated brass with antikink spring

## Kurzes Anschlussgewinde Pg | Short entry thread Pg

Material: Messing vernickelt  
Knickschutzfeder: Rostfreier Stahl A2  
Dichtung: TPE  
O-Ring : NBR  
Einsatztemperatur: -40°C / +100°C  
Schutzart: IP 68  
Eigenschaften: Sehr guter Schirmkontakt über die Kontakthülse bei in der Kabelverschraubung endendem Schirmgeflecht

Material: Nickel-plated brass  
Antikink spring: Stainless steel A2  
Seal: TPE  
O-ring : NBR  
Temperature range: -40°C / +100°C  
Protection class: IP 68  
Properties: Excellent shield contact through the contact sleeve with the braided shield terminating in the screwed cable gland

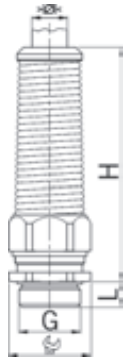

### Progress MS EMC FKN



Einteiliger Dichteinsatz  
nicht durchgehend isolierend

One-piece sealing insert  
not overall length insulated

G	> Ø < min mm	> Ø < max mm		H mm	L mm	Art.-Nr.   Art. No.	
Pg 7	4.5	6.0	15	60	6	1080.07.52.060	10
Pg 7	6.0	7.5	15	60	6	1080.07.52.075	10
Pg 9	6.0	8.0	18	69	6	1080.09.52.080	10
Pg 9	8.0	10.0	18	69	6	1080.09.52.100	10
Pg 11	6.0	8.0	18/21	69	6	1080.11.52.080	10
Pg 11	8.0	10.0	18/21	69	6	1080.11.52.100	10
Pg 13	8.0	11.0	24	88	6	1080.13.52.110	10
Pg 13	11.0	14.0	24	88	6	1080.13.52.140	10
Pg 16	8.0	11.0	24	88	6	1080.16.52.110	10
Pg 16	11.0	14.0	24	88	6	1080.16.52.140	10
Pg 21	13.0	16.0	30	104	7	1080.21.52.160	5
Pg 21	16.0	19.0	30	104	7	1080.21.52.190	5



Erhältlich mit Dichteinsatz gemäß EN 45545. Bei Anfragen oder Bestellung bitte ein F vor die Artikelnummer setzen.

Available with sealing inserts conformity with EN 45545. When placing an inquiry, prefix the article number by the capital F.

Langes Anschlussgewinde auf Anfrage

Long entry thread available on request

# Kabelverschraubungen Progress® EMV Serie 85 Messing mit Spannzange

## Cable glands Progress® EMC Series 85 nickel-plated brass with collet chuck

Anschlussgewinde metrisch | Entry thread metric

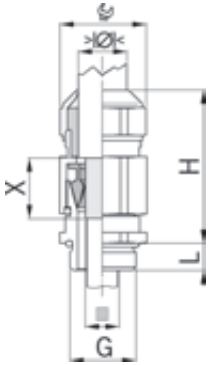

Material: Messing vernickelt  
 Dichtung: TPE  
 O-Ring : NBR  
 Zugentlastung: Ausführung A  
 Einsatztemperatur: -40°C / +100°C  
 Schutzart: IP 68 (bis 10 bar)  
 Weitere Schutzart: IP 69K  
 Eigenschaften: Für hohe Ableitströme, konzentrische Schirmkontaktierung mit tiefsten Übergangswiderständen und Transferimpedanzen

Material: Nickel-plated brass  
 Seal: TPE  
 O-ring : NBR  
 Strain relief: Version A  
 Temperature range: -40°C / +100°C  
 Protection class: IP 68 (up to 10 bar)  
 Further protection: IP 69K  
 Properties: For high leakage currents, concentric shield contact with minimal transfer resistances and transfer impedances

### Progress MS EMV Serie 85



Zweiteiliger Dichteinsatz nicht durchgehend isolierend

Two-piece sealing insert not overall length insulated

G	> Ø < min mm	> Ø < max mm	> ■ < mm	G mm	H mm	L mm	X mm	Art.-Nr.   Art. No.	
M16x1.5	4.5	6.0	3.0-4.5	18	40	6	14	1000.17.85.045	25
M16x1.5	6.0	10.5	4.5-8.0	18	42	8	16	1000.17.85.080	25
M16x1.5	8.0	15.0	7.5-10.0	24	47	8	20	1000.17.85.100	25
M20x1.5	8.0	15.0	7.5-12.0	24	47	8	20	1000.20.85.120	25
M20x1.5	12.5	20.5	10.0-14.0	30	59	8	21	1000.20.85.140	20
M25x1.5	12.5	20.5	10.0-16.0	30	59	8	21	1000.25.85.160	20
M25x1.5	17.0	25.5	14.0-19.0	36	66	8	24	1000.25.85.190	25
M32x1.5	17.0	25.5	14.0-22.0	36	66	10	24	1000.32.85.220	25
M32x1.5	24.0	33.0	21.0-25.0	46	68	10	24	1000.32.85.250	5
M40x1.5	24.0	33.0	21.0-30.0	46	68	12	24	1000.40.85.300	5
M50x1.5	33.0	42.0	29.0-38.0	55	82	13	30	1000.50.85.380	5
M63x1.5	33.0	42.0	29.0-38.0	70/55	82	15	30	1000.63.85.380	5
M63x1.5	40.0	52.0	35.0-44.0	70	78	15	26	1000.63.85.440	1

Erhältlich mit Dichteinsatz gemäß EN 45545. Bei Anfragen oder Bestellung bitte ein F vor die Artikelnummer setzen.

Available with sealing inserts conformity with EN 45545. When placing an inquiry, prefix the article number by the capital F.

#### Wichtig!

Um den Kabelschirm und die Kabellitzen optimal zu schützen ist es erforderlich, das der Kabelverschraubung beiliegende Kupfer-EMV-Tape zu montieren.

#### Important!

To provide the best possible protection for the cable shield and the cable, it is necessary to install a copper EMC tape.

Das Kupfer-Tape muss zwingend gemäß Illustration montiert werden! (Beispiel: Tape Scotch 3M Typ 1181)

The copper tape must be fixed according to the illustration! (example: Tape Scotch 3M Typ 1181)



# Kabelverschraubungen Progress® EMV Serie 85 Messing mit Spannzange

## Cable glands Progress® EMC Series 85 nickel-plated brass with collet chuck

Anschlussgewinde Pg | Entry thread Pg

Material: Messing vernickelt  
 Dichtung: TPE  
 O-Ring : NBR  
 Einsatztemperatur: -40°C / +100°C  
 Schutzart: IP 68 (bis 10 bar)  
 Weitere Schutzart: IP 69K  
 Eigenschaften: Für hohe Ableitströme, konzentrische Schirmkontaktierung mit tiefsten Übergangswiderständen und Transferimpedanzen

Material: Nickel-plated brass  
 Seal: TPE  
 O-ring : NBR  
 Temperature range: -40°C / +100°C  
 Protection class: IP 68 (up to 10 bar)  
 Further protection: IP 69K  
 Properties: For high leakage currents, concentric shield contact with minimal transfer resistances and transfer impedances

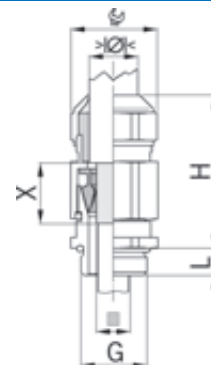

Zweiteiliger Dichteinsatz  
 nicht durchgehend isolierend

Two-piece sealing insert  
 not overall length insulated

G	>Ø< min mm	>Ø< max mm	>■< mm	EMC	H mm	L mm	X mm	Art.-Nr.   Art. No.	25
Pg 11	6.0	10.5	4.5-8.0	21/18	42	8	16	1000.11.85.080	25
Pg 11	8.0	15.0	7.5-12.0	24	47	8	20	1000.11.85.120	25
Pg 16	8.0	15.0	7.5-12.0	24	47	8	20	1000.16.85.120	25
Pg 16	12.5	20.5	10.0-15.0	30	59	8	21	1000.16.85.150	25
Pg 21	12.5	20.5	10.0-16.0	30	59	8	21	1000.21.85.160	20
Pg 21	17.0	25.5	14.0-19.0	36	66	8	24	1000.21.85.190	25
Pg 29	17.0	25.5	14.0-22.0	38/36	66	10	24	1000.29.85.220	20
Pg 29	24.0	33.0	21.0-25.0	46	68	10	24	1000.29.85.250	5



Erhältlich mit Dichteinsatz gemäß EN 45545. Bei Anfragen oder Bestellung bitte ein F vor die Artikelnummer setzen.

Available with sealing inserts conformity with EN 45545. When placing an inquiry, prefix the article number by the capital F.

**Wichtig!**

Um den Kabelschirm und die Kabellitzen optimal zu schützen ist es erforderlich, das der Kabelverschraubung beiliegende Kupfer-EMV-Tape zu montieren.

**Important!**

To provide the best possible protection for the cable shield and the cable, it is necessary to install a copper EMC tape.

Weitere Abmessungen auf Anfrage

Further dimensions upon request

Das Kupfer-Tape muss zwingend gemäß Illustration montiert werden! (Beispiel: Tape Scotch 3M Typ 1181)

The copper tape must be fixed according to the illustration! (example: Tape Scotch 3M Typ 1181)







passend zu Kabelverschraubungen Progress® | suitable for cable glands Progress®

### Erdungslaschen zu Kabelverschraubungen | Grounding straps suitable for cable glands

Material: Messing roh  
 Einsatztemperatur: -60°C / +200°C  
 Einsatzbereich: Löt- oder steckbar  
 6,3 x 1,0 mm

Material: Brass raw  
 Temperature range: -60°C / +200°C  
 Application: Solderable or pluggable  
 6,3 x 1,0 mm

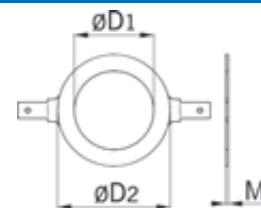

#### Erdungslaschen zu Kabelverschraubungen Anschlussgewinde metrisch

G	ØD1 mm	ØD2 mm	M mm	Art.-Nr.   Art. No.	
M12 / Pg 7	13.0	24	1	1007.80.10	100
M16	16.5	24	1	1017.80.10	100
M20 / Pg 13	20.7	28	1	1020.80.10	100
M25	25.5	32	1	1025.80.10	100
M32	33.0	40	1	1032.80.10	100
M40	40.5	52	1	1040.80.10	100
M50	50.5	62	1	1050.80.10	50
M63	63.5	78	1	1063.80.10	50



#### Erdungslaschen zu Kabelverschraubungen Anschlussgewinde Pg

G	ØD1 mm	ØD2 mm	M mm	Art.-Nr.   Art. No.	
M12 / Pg 7	13.0	24	1	1007.80.10	100
Pg 9	16.0	24	1	1009.80.10	100
Pg 11	19.0	28	1	1011.80.10	100
M20 / Pg 13	20.7	28	1	1020.80.10	100
Pg 16	23.0	32	1	1016.80.10	100
Pg 21	29.0	37	1	1021.80.10	100
Pg 29	38.0	52	1	1029.80.10	50
Pg 36	48.0	62	1	1036.80.10	50



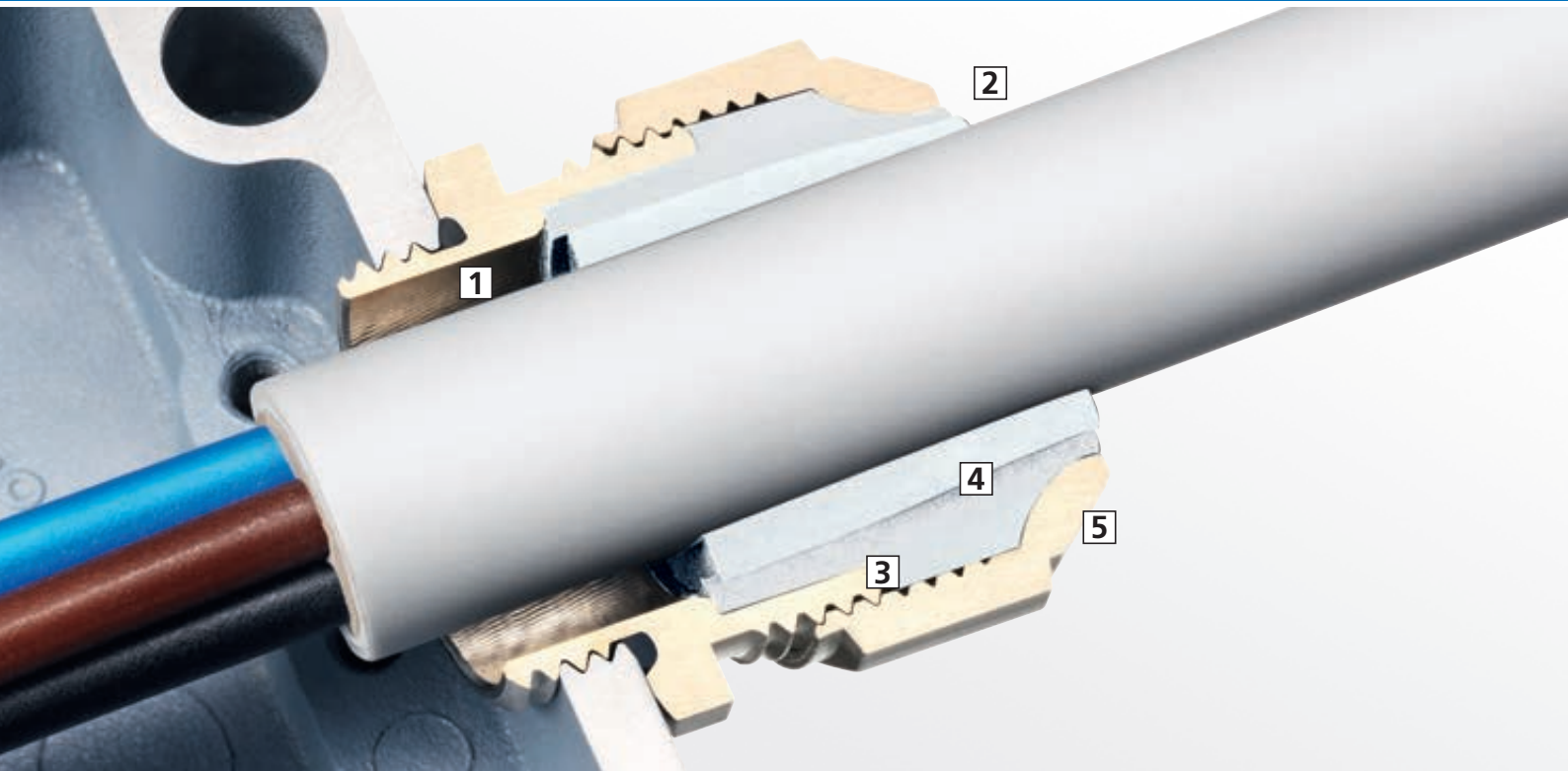

### Progress® Kabelverschraubungen in Metall für den Einsatz in Schienenfahrzeugen

AGRO Progress® Kabelverschraubungen aus Metall können mit Dichteinsätzen aus einem speziellem TPE bestückt werden. In dieser Ausführung sind sie zertifiziert nach EN 45545 und können bedenkenlos für alle Anwendungen und Anordnungen im Schienenfahrzeugbau eingesetzt werden.

#### 1 Kurze, lange oder Spezial-Anschlussgewinde

Kabelverschraubungen Progress® mit kurzem oder langem Anschlussgewinde in metrischer oder Ausführung können bei vorhandenem Öffnungsgewinde oder mit Gegenmutter verwendet werden.

#### 2 Sichtbare Sicherheit

Der kleine Wulst des Dichteinsatzes bestätigt das richtige Anzugsmoment.

#### 3 Hoher Verdrehschutz

Die im Unterteil integrierte Längsrandrierung sorgt über den Dichteinsatz für eine hohe Verdrehsicherheit.

#### 4 Kompressionstechnik

Die ein- oder zweiteiligen Dichteinsätze werden durch die Druckmutter verpresst und eine außerordentlich Kabel schonende Zugentlastung wird erreicht. Der Kabelmantel bleibt selbst bei dynamischen Anwendungen langfristig intakt.

#### 5 Garantierte Dichtigkeit

Auf den Dichteinsatz abgestimmte Innenkonturen sorgen für eine zielgerichtete Verformung des Dichteinsatzes und garantieren somit dessen perfekte Abdichtung. Die Schutzart IP 68 bis 10 bar sowie IP 69K ermöglichen eine breite Anwendung.

### Metal cable glands Progress® for railway applications

AGRO Progress® metal cable glands can be equipped with sealing inserts made of a special TPE. These versions are certified according to EN 45545 and can be used with confidence for any rolling stock application.

#### 1 Short, long or special entry thread

Cable glands Progress® with short or long entry thread designed as metric or Pg can be used with existing opening threads or with a counter nut.

#### 2 Visible safety

The small bead in the sealing insert confirms the correct tightening torque.

#### 3 High distortion protection

The integrated retaining grooves in the lower part and in the sealing insert grant against twisting.

#### 4 Compression technology

The one or two-part sealing inserts are being compressed by a compression nut. A very cable-protecting strain relief is produced. The cable sheath will not be harmed, even on the occasion of long-term dynamic stress.

#### 5 Guaranteed seal

Inner contours matched to the sealing insert ensure a targeted deformation of the insert and thus guarantee its tightness in compliance with protection class IP 68 up to 10 bar and IP 69K for a wide range of applications.



Kabelverschraubungen Progress® Metall nach EN 45545  
Cable glands Progress® Metall according to EN 45545



106 - 107

- Progress® Messing  
Progress® nickel-plated brass
- Standard  
Standard
- EMV Kabelverschraubungen  
EMC cable glands
- Kombi-Schlauchverschraubungen  
Combination conduit glands
- Winkel  
Elbows
- für mehrere Kabel  
for installation of multiple cables
- mit Dichteinsatz ohne Bohrung  
with sealing insert without drilled hole
- für spezielle Kabel  
for special cables
- mit Knickschutzfeder  
with antitink spring
- mit Trompete und / oder Klemmbacken  
with trumpet and / or clamps

Ausführung / Version	Progress® Messing Progress® nickel-plated brass	Standard Standard	EMV Kabelverschraubungen EMC cable glands	Kombi-Schlauchverschraubungen Combination conduit glands	Winkel Elbows	für mehrere Kabel for installation of multiple cables	mit Dichteinsatz ohne Bohrung with sealing insert without drilled hole	für spezielle Kabel for special cables	mit Knickschutzfeder with antitink spring	mit Trompete und / oder Klemmbacken with trumpet and / or clamps
<b>Kompressionstechnik</b> Compression technology	•	•	•	•	•	•	•	•	•	•
<b>Gewinde / Thread</b>										
Anschlussgewinde metrisch Entry thread metric	•	•	•	•	•	•	•	•	•	•
Anschlussgewinde Pg Entry thread Pg	•	•	•	•	•	•	•	•	•	•
Kurzes Anschlussgewinde (Standard) Short entry thread (standard)	•	•	•	•	•	•	•	•	•	•
Langes Anschlussgewinde Long entry thread	•	•	•	•	•	•	•	•	•	•
Sondergewinde (extra lang, Innengewinde) Special thread (extra long, internal thread)	•	-	-	-	-	-	-	-	-	-
<b>Dichteinsatz / Sealing insert</b>										
für Rundkabel for round cables	•	•	•	•	•	-	-	•	•	•
für Flachkabel for flat cables	•	-	-	-	-	-	•	-	-	-
für mehrere Kabel (Multi-Dichteinsatz) for multi sealing insert	•	•	-	-	•	-	-	-	-	-
Vollgummi-Dichteinsatz Solid rubber sealing insert	•	•	-	-	-	•	-	-	-	-
einteiliger Dichteinsatz One-piece sealing insert	•	•	-	-	•	•	•	•	-	-
zweiteiliger Dichteinsatz Two-piece sealing insert	•	•	•	•	-	-	-	•	•	•
<b>Technische Besonderheiten / Technical features</b>										
Vibrationsschutz Vibration resistance	•	•	•	•	•	•	•	•	•	•
<b>Material / Material</b>										
Messing vernickelt Nickel-plated brass	•	•	•	•	•	•	•	•	•	•
rostfreier Stahl A2 Stainless steel A2	•	-	-	-	•	•	•	-	-	-

1  
2  
3  
4  
5  
6  
7  
8  
9  
10  
11  
12

# AGRO Kabelverschraubungen Progress® nach EN 45545-2

## AGRO Cable glands Progress® according to EN 45545-2



### Beste Resultate bei Prüfungen nach EN 45545-2 (Komponenten)

Die Dichteinsätze der Progress® Kabelverschraubung sind aus einem speziellen TPE gefertigt und sind im anspruchsvollsten **Hazard Level 3 zertifiziert**.

Die geforderten Werte für Hazard Level 3 wurden sowohl im Außen- als auch im Innenbereich deutlich übertroffen:

### Best results in testing according to EN 45545-2 (Components)

The seal inserts of Progress® cable glands are made from a special TPE and certified to the demanding **Hazard Level 3**.

The stipulated values for Hazard Level 3 were exceeded, for both indoor and outdoor areas: **Best results in testing according to EN 45545-2 (Components)**

	Normwert für HL 3 außen Requirement for HL 3 outdoor	Normwert für HL 3 innen Requirement for HL 3 indoor	AGRO Resultat AGRO resultA
Sauerstoffindex   Oxygen index	Min. 32%	Min. 32%	<b>39%</b>
Rauchgasdichte Ds   Smoke gas density Ds	Max. 300	Max. 150	<b>110</b>
Toxizität CIT   Toxicity CIT	Max. 1.5	Max. 0.75	<b>0.16</b>

### Vorgaben der EN 45545-3 übertroffen!

Ziel der **EN 45545-3** ist es, die Brandausbreitung durch Materialanforderungen zu begrenzen. Wenn Kabel durch Feuerschutzabschlüsse geführt werden, gelten diese Anforderungen auch für Kabelverschraubungen.

AGRO Progress® Kabelverschraubungen aus Metall übertreffen die Vorgaben der **EN 45545-3** bei weitem und erreichen die sehr hohe Feuerwiderstandsklasse **E30**. Die Dichteinsätze sind mindestens 30 Minuten lang dicht und verhindern einen Flammenübertrag auf die dem Feuer abgewandte Seite und es bilden sich keine Spalten. Sie können aus brandschutztechnischer Sicht bedenkenlos in allen Schienenfahrzeugen eingesetzt werden.

### Exceeding the demands of EN 45545-3!

The aim of **EN 45545-3** is to limit fire spread by specifying the performance of materials and components. If cables are routed through fire barriers, the requirements apply also to the cable glands used.

AGRO Progress® metal cable glands easily exceed the requirements of **EN 45545-3** and satisfy the very high demands of fire resistance class **E30**. This means that the seal inserts remain impervious and prevent the spread of fire through the gland for at least 30 minutes. They do not crack or fissure. From a fire protection perspective, they can be used without hesitation in all railway vehicles.

	Einbaulage vertikal Vertical installation	Einbaulage horizontal Horizontal installation	Klassierung Classification
AGRO Resultat AGRO Result	44 min	41 min	<b>E30</b>

# AGRO Kabelverschraubungen Progress® nach EN 45545-2

## AGRO Cable glands Progress® according to EN 45545-2

Lange und kurze Anschlussgewinde metrisch, Pg | Long and short entry threads metric, Pg

**Material:** Messing vernickelt  
**Material Dichteinsatz:** Spezial AGRO TPE  
**Farbe Dichteinsatz:** Hellgrau RAL 7035  
**Gewinde:** M12 bis M63  
Pg 7 bis Pg 48  
**Einsatztemperatur:** -50°C / +105°C  
**Schutzart:** IP 68 / IP 69 K  
**Normen:** EN 50262 / EN 62444

**Material:** Nickel-plated brass  
**Material sealing insert:** Special AGRO TPE  
**Colour sealing insert:** Light grey RAL 7035  
**Threads:** M12 to M63  
Pg 7 to Pg 48  
**Temperature range:** -50°C / +105°C  
**Protection class:** IP 68 / IP 69 K  
**Norms:** EN 50262 / EN 62444



Alle Kabelverschraubungen, welche mit Dichteinsätzen für Bahnapplikationen gemäß EN 45545 erhältlich sind, sind im Katalog mit einem entsprechenden Vermerk gekennzeichnet.

Suchen Sie im Katalog oder auf der Website die Standard-Kabelverschraubung mit dem gewünschten Klemmbereich und dem benötigten Gewinde. Stellen Sie der betreffenden Artikel Nummer den Großbuchstaben „F“ voran und sie werden die Variante mit Dichteinsatz in Spezial TPE erhalten.

Eine Kabelverschraubung M20 mit einem langen metrischen Anschlussgewinde und einem Klemmbereich von 8.0 - 14.5 mm erhält die Artikel Nummer F1160.20. Zur Vereinfachung benutzen Sie den Produktfinder auf unserer Website [www.kaiser-elektro.de](http://www.kaiser-elektro.de).

All cable glands, which are available with sealing inserts for railway applications according to EN 45545 are marked in the catalogue with an appropriate note.

Search the standard cable gland with the desired clamping range as well as with the required entry thread in our catalogue or on the website. When placing an order or inquiry, prefix the article number by the capital „F“ and you will get the version with sealing insert made of special TPE.

A cable gland M20 with a long metric entry thread and a clamping range of 8.0 - 14.5 mm gets the item number F1160.20. The Product Finder on our website [www.kaiser-elektro.de](http://www.kaiser-elektro.de) simplifies your research.

## AGRO Kabelverschraubungen

Navigationsspfad →

ÜBERSICHT

PRODUKTSUCHE

Installationsart (2)

ALLE ▼

Material (1)

Messing vernickelt ▼

Gewinde (1)

M20x1.5 ▼

Minimale Einsatztemperatur (4)

ALLE ▼

Maximale Einsatztemperatur (4)

ALLE ▼

Kabeldurchmesser (mm)

14 ▼

63 Produkte

FILTER ZURÜCKSETZEN

Produkt

Artikelnummer



**Kabelverschraubungen Progress® Messing**

Gewinde: M20x1.5  
 minimaler Klemmbereich: 8.0  
 maximaler Klemmbereich: 14.5

**F** 1160.20

MERKEN





# EX Kabelverschraubungen

## EX cable glands

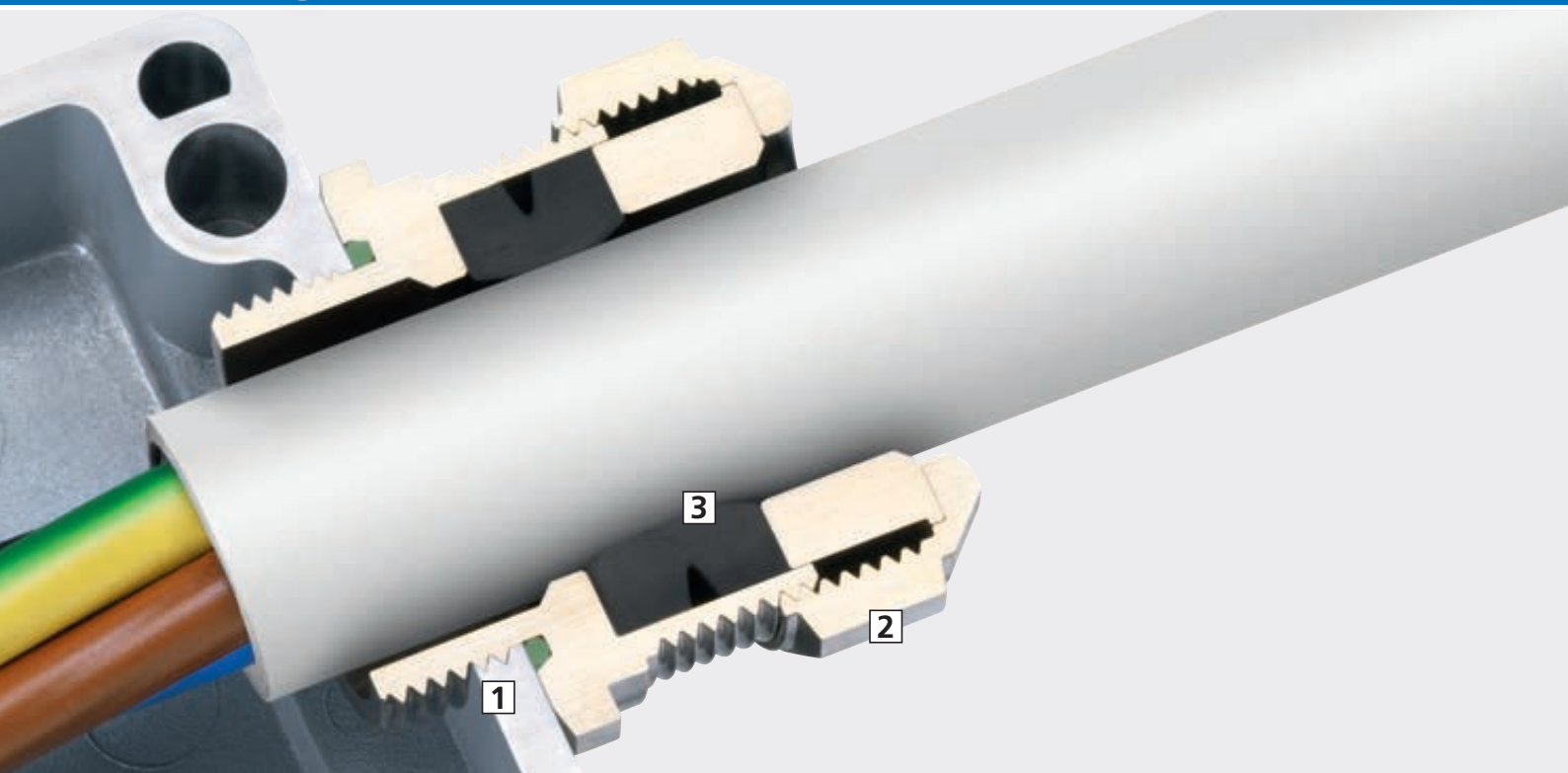

In vielen Bereichen wie zum Beispiel der Chemischen Industrie, Lackierereien, Offshore, Raffinerien, Tankstellen, Textil- und Papierindustrie, Nahrungsmittelindustrie, Glas- und/oder Keramikindustrie, Holzverarbeitung und in vielen weiteren Industrien, werden Geräte in explosionsgefährdeten Bereichen betrieben. Aufgrund der hohen Gefährdung von Personen sowie Sachwerten im Falle einer Explosion gelten speziell in explosionsgefährdeten Bereichen besonders strenge rechtliche und technische Anforderungen. AGRO Ex-Kabelverschraubungen aus Messing oder Kunststoff erfüllen die strengsten Anforderungen und sorgen in explosionsgefährdeten Bereichen für eine sichere Kabeleinführung. Alle Kabelverschraubungen sind zertifiziert und haben eine entsprechende EG-Baumusterprüfbescheinigung. Durch die IECEx Zertifizierung ist ein weltweiter Einsatz möglich.

### 1 Kurze, lange oder Spezial-Anschlussgewinde

Ex Kabelverschraubungen Progress® mit kurzem oder langem Anschlussgewinde in metrischer, Pg-, Gasrohr oder NPT-Ausführung können bei vorhandenem Gewinde oder Durchgangsbohrung mit Gegenmutter verwendet werden.

### 2 Stabile Schlüsselflächen

Große, stabile Schlüsselflächen an der Druckmutter vereinfachen das Anziehen mit dem Montagewerkzeug.

### 3 Garantierte Dichtigkeit

Auf den Dichteinsatz abgestimmte Innenkonturen sorgen für eine zielgerichtete Verformung des Dichteinsatzes und garantieren somit dessen perfekte Abdichtung. Die Schutzart IP 68 bis 10 bar (druckfeste Kapselung 30 bar) sowie IP 69K ermöglichen eine breite Anwendung.

In many areas such as the chemical industry, paint shops, offshore refineries, petrol stations, the textile and paper industry, the food industry, glass and / or ceramics industry, wood processing and many other industries, equipment are operated in explosive areas. Due to the high risk to persons and property in case of an explosion, especially strict legal and technical requirements apply to explosive areas in particular. AGRO Ex cable glands made of brass or plastic comply with the strictest requirements and ensure safe cable entry in explosive areas. All cable glands are certified accordingly and come with an EC type-examination certificate. IECEx certification allows for worldwide use.

### 1 Short, long or special entry thread

Ex Cable glands Progress® with short or long entry thread designed as metric, Pg, gas-pipe or NPT can be used with existing opening threads or with a counter nut.

### 2 Stable spanner flats

Large, stable spanner flats on the nut simplify tightening using the assembly tool.

### 3 Guaranteed seal

Inner contours matched to the sealing insert ensure a targeted deformation of the insert and thus guarantee its tightness in compliance with protection class IP 68 up to 10 bar (flameproof enclosure 30 bar) and IP 69K for a wide range of applications.¥



<p>Kabelverschraubungen Messing druckfeste Kapselung Ex d IIC Cable glands nickel-plated brass for flameproof enclosure Ex d IIC</p>		<p>115 - 117</p>	<p>1</p>
<p>Kabelverschraubungen Ex Compact Messing druckfeste Kapselung Ex d IIC / Ex e II Cable glands Ex Compact nickel-plated brass for flameproof enclosure Ex d IIC</p>		<p>118</p>	<p>2</p>
<p>Zubehör zu Kabelverschraubungen Messing druckfeste Kapselung Ex d IIC Cable gland accessoires nickel-plated brass for flameproof enclosure Ex d IIC</p>		<p>119 - 120</p>	<p>3</p>
<p>Kabelverschraubungen Progress® Messing erhöhte Sicherheit Ex e II Cable glands Progress® nickel-plated brass increased safety Ex e II</p>		<p>121 - 122</p>	<p>4</p>
<p>Kabelverschraubungen Progress® Messing für mehrere Kabel erhöhte Sicherheit Ex e II Cable glands Progress® nickel-plated brass for installation of multiple cables increased safety Ex e II</p>		<p>123 - 124</p>	<p>5</p>
<p>Kabelverschraubungen Progress® Messing mit Klemmbacken erhöhte Sicherheit Ex e II Cable glands Progress® nickel-plated brass with clamps increased safety Ex e II</p>		<p>125 - 127</p>	<p>6</p>
<p>Kabelverschraubungen Progress® Messing mit Trompete und Klemmbacken erhöhte Sicherheit Ex e II Cable glands Progress® nickel-plated brass with trumpet and clamps increased safety Ex e II</p>		<p>128 - 129</p>	<p>7</p>
<p>Kabelverschraubungen Progress® EMV Rapid Messing mit Kontaktscheibe erhöhte Sicherheit Ex e II Cable glands Progress® EMC Rapid nickel-plated brass with contact disc increased safety Ex e II</p>		<p>130</p>	<p>8</p>
<p>Kabelverschraubungen Progress® EMV Messing mit Kontakthülse erhöhte Sicherheit Ex e II Cable glands Progress® EMC nickel-plated brass with contact sleeve increased safety Ex e II</p>		<p>131 - 132</p>	<p>9</p>
<p>Kabelverschraubungen Progress® EMV Messing mit Kontakthülse und Klemmbacken erhöhte Sicherheit Ex e II Cable glands Progress® EMC nickel-plated brass with contact sleeve and clamps increased safety Ex e II</p>		<p>133 - 134</p>	<p>10</p>
<p>Kombi-Schlauchverschraubung Progress® Messing erhöhte Sicherheit Ex e II Combination conduit glands Progress® nickel-plated brass increased safety Ex e II</p>		<p>135</p>	<p>11</p>
<p>Kabelverschraubungen Progress® Kunststoff GFK erhöhte Sicherheit Ex e II Synthetic cable glands Progress® GFK increased safety Ex e II</p>		<p>136 - 139</p>	<p>12</p>
<p>Kabelverschraubungen Progress® Kunststoff GFK für mehrere Kabel erhöhte Sicherheit Ex e II Synthetic cable glands Progress® GFK for installation of multiple cables increased safety Ex e II</p>		<p>140 - 141</p>	<p>13</p>
<p>Kabelverschraubungen Progress® Kunststoff GFK erhöhte Sicherheit Ex e II und Eigensicherheit Ex i II Synthetic cable glands Progress® GFK increased safety Ex e II and intrinsic safety Ex i II</p>		<p>142 - 143</p>	<p>14</p>
<p>Zubehör zu Kabelverschraubungen Messing und Kunststoff erhöhte Sicherheit Ex e II Cable gland accessoires nickel-plated brass and synthetic for flameproof enclosure Ex d IIC</p>		<p>144 - 149</p>	<p>15</p>

### Richtlinien & Vorschriften

#### ATEX 95 (Richtlinie 94/9 EG)

1994 nahm der Europäische Rat die Richtlinie 94/9 EG „Für Geräte und Schutzsysteme zur bestimmungsgemäßen Verwendung in explosionsgefährdeten Bereichen“ an. Diese Richtlinie, bekannt als ATEX95 (vom französischen „atmosphère explosible“), regelt den Explosionsschutz in elektrischen Anlagen auf dem Gebiet der EU.

Die ATEX95 definiert im Anhang verschiedene Module für die Inverkehrbringung von Geräten für den Einsatz in explosionsgefährdeten Bereichen. Oft verwendet, so auch bei AGRO, werden die Module III und IV, woraus folgende Zertifikate resultieren:

- Die EG Baumusterprüfbescheinigung
- Die QS-Anerkennung

#### ➔ Neue Richtlinie 2014/34 EU ab 20.04.2016

Beide Zertifikate werden von akkreditierten Prüfstellen nach erfolgreich absolvierten Prüfungen ausgestellt.

#### EG-Baumusterprüfbescheinigung

Die EG-Baumusterprüfbescheinigung ist dasjenige Dokument, welches auf Grund der erfolgreichen technischen Prüfungen ausgestellt wird.

#### QS-Anerkennung

Eine Forderung aus der ATEX95 ist die geprüfte und überwachte Produktion. Sie stellt sicher, dass die in Verkehr gebrachten Produkte mit den Prüfmustern der EG-Baumusterprüfbescheinigung übereinstimmen. Für Firmen, welche über ein zertifiziertes QM-System nach ISO 9001:2008 verfügen, wird ein zusätzliches Ex-Audit nötig. Ihm folgen in periodischen Abständen Wiederholungs-Audits.

#### CE-Konformitätserklärung

Auf der EG-Baumusterprüfbescheinigung und der QS-Anerkennung basiert die CE-Konformitätserklärung. Damit erklärt der Hersteller die Einhaltung der geltenden Normen und Vorschriften. Sichtbar wird dies durch die CE-Kennzeichnung.

### Installation



**Für das Errichten und Betreiben sind die Vorschriften gemäß IEC / EN 60079-14, das Gerätesicherheitsgesetz, die allgemein anerkannten Regeln der Technik und diese Betriebsanleitung maßgebend. Damit der geforderte IP-Schutzgrad gemäß EN 60529:2014 erreicht wird, müssen die Verschraubungen sachgerecht im elektrischen Betriebsmittel eingebaut werden.**

Bei Montage von Erweiterung oder Reduzierung ist darauf zu achten, dass maximal 1 Stk. eingebaut wird. Das Ineinanderschrauben mehrerer Reduktionen / Erweiterungen ist nach Norm nicht zulässig!

Bitte beachten Sie unbedingt unsere Montage-, Betriebs- und Wartungsanleitungen in den Zusatzinformationen Kapitel 12

Die Daten der Kabelverschraubungen unter Punkt 3 sind beim Einbau zu berücksichtigen. Beim Einsatz in Kunststoffgehäuse müssen die Kabelverschraubungen in den Potentialausgleich einbezogen werden. Die auf der Tabelle für die jeweiligen Größen angegebenen Anzugsdrehmomente für die Druckmutter und die Klemmbackenschrauben sowie die ergänzenden Hinweise sind zu beachten.

### Instandhaltung



**Die für Wartung, Instandhaltung und Prüfung geltenden Bestimmungen der IEC / EN 60079-14 sind einzuhalten. Im Rahmen der Wartung sind vor allem die für die Zündschutzart maßgebenden Teile zu prüfen.**

### Directives & Regulations

#### ATEX95 + Directive 94/9 EC

In 1994, the Council of Europe adopted Directive 94/9 EC «For equipment and protective systems» for use for the intended purpose in potentially explosive areas. This, known as ATEX95 (from the French «atmosphère explosible»), regulates the explosion protection in electrical installations in the EU.

In its appendix the ATEX95 defines various modules for bringing into circulation equipment for use in potentially explosive atmospheres. Frequently used, as is also the case at AGRO, are modules III and IV which give rise to two certificates.

- The EC design test certificate
- The QA certificate

#### ➔ New Directive 2014/34 EU from 20.04.2016 on

Both certificates are issued by accredited test centres after successful tests.

#### EC type test certificate

The EC examination test certificate is the document which is issued on the basis of successful technical tests.

#### QA certificate

A feature of ATEX95 is tested and monitored production. It ensures that the products brought onto the market correspond to the test samples of the EC design test certificate. For companies which have a certified QM system according to ISO 9001:2008, an additional explosion audit is necessary. It is followed by repeat audits at periodic intervals.

#### CE Declaration of Conformity

The CE Declaration of Conformity is based on the EC design test certificate and the QA certificate. With this, the manufacturer declares compliance with the valid standards and regulations. This is evident from the CE symbol, which is part of the marking.

### Installation



**The regulations according to IEC / EN 60079-14, the equipment safety law, the generally acknowledged rules of the industry and these operating instructions are applicable for installation and operation. In order to ensure the required IP protection category according to EN 60529:2014 is achieved, the cable glands must be properly installed in the electrical equipment.**

When installing enlarging or reduction fittings, make sure to install one piece only. The norm interdicts to screw several reduction / enlarging fittings into each other!

Please unconditionally take into account our assembly, instruction and maintenance guidelines in chapter 12, additional information.

The data for the cable gland under section 3 must be taken into account on installation. When used in enclosures made of plastic, the cable glands must be included in the equipotential bonding system. The tightening torques stated in the table for the respective sizes of compression cap nuts and clamps and the additional information must be taken into account.

### Maintenance



**The provisions of IEC / EN 60079-14 which are applicable for service, maintenance and testing must be complied with. During maintenance, in particular the parts critical for the ignition protection category must be tested.**

In Produktions- und Arbeitsstätten können sich Gefahrenbereiche für Explosionen ausbilden, wenn die ersten zwei Voraussetzungen für eine Explosion erfüllt sind. Typische Gefahrenbereiche entstehen in chemischen Fabriken, Raffinerien, Lackfabriken, Lackierereien, Reinigungsanlagen, Mühlen und Lagern für Mahlprodukte, Großbäckereien und anderen brennbaren Stäuben, in Tank- und Verladeanlagen für brennbare Gase, Flüssigkeiten und Feststoffe.

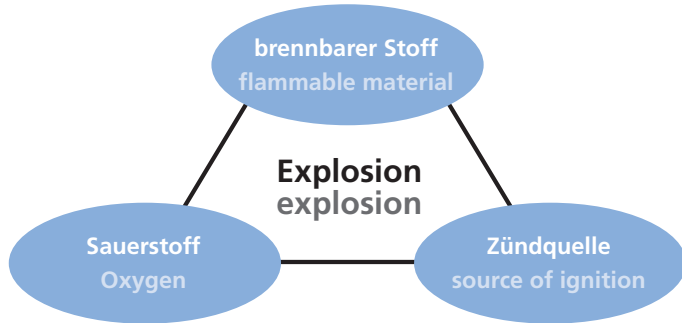

In production and work places, explosive areas may arise when the first two preconditions for an explosion are met. Typical danger zones are created in chemical factories, refineries, paint and varnish factories, paint shops, cleaning plants, mills and storehouses for mill products, large bakeries and other flammable dusts, in tank and loading facilities for inflammable gases, liquids and solid matter.

### Beispiele für Zoneneinteilungen im Ex-Bereich

#### Examples for zone classifications in hazardous area

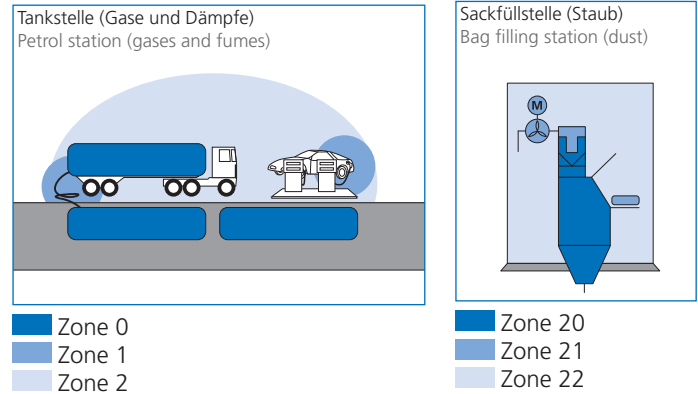

Weiterhin spielt für das Entstehen einer Explosion die Konstellation dieser Faktoren eine Rolle. So kann z.B. eine übersättigte Atmosphäre nicht zünden (Gemisch zu fett) ebenso eine Atmosphäre mit zu hohem Sauerstoffanteil (Gemisch zu mager).

Furthermore, for the appearance of an explosion, the constellation of these factors is important. If the atmosphere is saturated (rich mixture) it cannot ignite, also if the proportion of oxygen is too high (lean mixture).

Die Gerätekennzeichnung – unterschieden durch Buchstaben – sagt etwas über die explosionsfähigen Stoffe aus:

The marking of devices, varied by letters, gives information about the flammable material:

- M** vorangestellt steht für untertägige Bergwerke
- G** nachgestellt steht für brennbare Gase, Nebel oder Dämpfe und
- D** nachgestellt für Stäube

- M** mining
- G** flammable gas, fog, steam
- D** flammable dust

Ziffern drücken den Grad aus.

Figures express the level.

- 1** steht für ein sehr hohes Maß an Sicherheit
- 2** steht für ein hohes Maß an Sicherheit
- 3** steht für ein normales Maß an Sicherheit

- 1** very high degree of safety
- 2** high degree of safety
- 3** normal degree of safety

Damit ergibt sich die Zuordnung der Gerätekategorien zu den Zonen.

The outcome of this is the assignment of devices by zones.

Die Definition der Ex-Zonen und der Zusammenhang der explosionsgefährdeten Bereiche mit der Häufigkeit der Zündquellen im Übertagebetrieb.

The definition of the hazardous area and the combination between explosive areas and frequency by sources of ignition (no mining)

Zoneneinteilung / Zone classification						
	Gas / gas			Staub / dust		
	Zone 0	Zone 1	Zone 2	Zone 20	Zone 21	Zone 22
Häufigkeit der Explosionsgefahr frequency of explosion risk	ständig oder langfristig allways or long-term	gelegentlich casual	selten und kurzfristig rare and for a short time	wie Zone 0 Staubablagerungen allein bilden keine Zone 20 like zone 0 dust deposit alone is not generate zone 20	wie Zone 1 like zone 1	wie Zone 2 oder wenn Staubanhäufungen vorhanden sind like zone 2 or if dust deposit occurs
Häufigkeit der Zündquellen von elektrischen Betriebsmitteln frequency sources of ignition in electrical equipment	niemals (auch nicht bei seltenen Betriebsstörungen) never (also not on rare breakdowns)	sehr selten (auch nicht bei häufiger zu erwartenden Betriebsstörungen) very rare (also not on frequently expected disturbances)	gelegentlich (z.B. bei Betriebsstörung) casual (e.g. on disturbances)	wie Zone 0 like zone 0	wie Zone 1 like zone 1	wie Zone 2 like zone 2



# Generelle Informationen Explosionsschutz

## Information about explosion protection

Gerätezuordnung nach Zonen Device assignment by zones			
Bereich Range	Stufe Explosionsgefahr Level explosion risk	Erforderliche Kennzeichnung der einsetzbaren Betriebsmittel Required marking of applicable equipment	
		Gerätegruppe* / Device*	Kategorie / Category
Gruppe II group II	Zone 0	II	1 G
Gruppe II group II	Zone 1	II	2 G oder / or 1 G
Gruppe II group II	Zone 2	II	3 G oder / or 2 G
Gruppe II group II	Zone 20	II	1 D
Gruppe II group II	Zone 21	II	2 D oder / or 1 D
Gruppe II group II	Zone 22	II	3 D oder wie / or like 2 D

\* Die Geräte werden in zwei Gruppen unterteilt. Gruppe 1 gilt für schlagwettergefährdete Geräte zur Verwendung im Bergbau und wird hier nicht weiter beschrieben.  
The equipment is divided into two groups. Group 1 is applicable to equipment at risk from firedamp and intended for use in mining and will not be describe further here.



Für elektrische Betriebsmittel der Gruppe II wird weiter eine Unterteilung in Explosionsgruppen und Temperaturklassen vorgenommen.

For electrical equipment of group II a further classification in explosion group and temperature classes has been taken.

Einteilung in Temperaturklassen Classification by temeratur class		
Zündtemperatur in °C Ignition temperature in °C	Temperaturklasse Temperature class	max. Oberflächentemperatur in °C des Betriebsmittels max. surface temperature in °C
≥ 450	T1	450
300-450	T2	300
200-300	T3	200
135-200	T4	135
100-135	T5	100
85-100	T6	85



### Einteilung von Explosionsgruppen bei Gas- Ex-Schutz

Brennbare Gase/Dämpfe/Nebel unterscheiden sich in ihrem Zünddurchschlagsvermögen. Daher unterteilt man sie in Explosionsgruppen. Durch Versuchsreihen wurde hierbei die Grenzspaltweite MESG (Maximum Experimental Safe Gap) und der Mindestzündstrom MIC (Minimum Ignition Current) ermittelt. Die Gefährlichkeit der Gase nimmt hierbei von IIA nach IIC zu.

### Classification of explosion groups for gas protection

Flamable gas/steam/fog differs in it's ignition breakdown capacity. Therefore they are classified in explosion groups. Test series showed the MESG (Maximum Experimental Safe Gap) and the MIC (Minimum Ignition Current) The risikness riscs from IIA to IIC.

Explosionsgruppe Explosions group	Grenzspaltwerte MESG Maximum experimental safe gap	Mindestzündstromverhältnis bezogen auf Methan Minimum ignition current relating to methane
II A	> 0.9 mm	> 0.8
II B	0.5 mm bis 0.9 mm	0.45 bis 0.8
II C	< 0.9 mm	< 0.45

Schematische Darstellung der Funktionsprinzipien von einzelnen Zündschutzarten, für die die KAISER Gruppe Kabelverschraubungen anbietet.

Schematical diagram of functional principle of some protection types, for which offers AGRO cable glands

Zündschutzart nach IEC bzw. EN type of protection by IEC and/or EN	Grundprinzip basic principle	Schematische Darstellung schematic view
IEC / EN 60079-1	<p>Ex d druckfeste Kapselung Kommt es im Innern eines druckfest gekapselten Gehäuses zu einer Explosion wird eine Übertragung der Explosion nach außen ausgeschlossen</p> <p>Ex d flameproof enclosures If an explosion occurs within a flameproof enclosure the escape to outside atmosphere will be prevented</p>	
IEC / EN 60079-7	<p>Ex e erhöhte Sicherheit Die Entstehung von Funken und hohen Temperaturen wird mit einem erhöhten Grad an Sicherheit ausgeschlossen</p> <p>Ex e increased safety The appearance of sparks ignitions and / or high temperatur is prevented by an increased level of security standard.</p>	
IEC / EN 60079-11	<p>Ex i Eigensicherheit Die Energie im Stromkreis wird so gering gehalten, dass zündfähige Funken, Lichtbögen oder hohe Temperaturen nicht entstehen können</p> <p>Ex i intrinsic safety The curcuit energy has to be kept under a certain level to prevent the appearance of ignitable sparks, electrical arcs and high temperature</p>	



### Anwendungen

Die Kabelverschraubungen für explosionsgeschützte Geräte sind somit für die meisten Anwendungen an explosionsgeschützten Motoren, Schalt- und Steuergeräten, Gehäusen usw. geeignet, die in der Industrie, in der chemischen und petrochemischen Industrie eingesetzt werden.

### Applications

The AGRO cable glands for explosion-protected equipment are therefore suitable for most of the applications in explosion-hazardous motors, switch and control gears, housings etc. used in industrial fields such as in the machinery and automation industry, in the chemical and petrochemical industry.





**Kabelverschraubung Messing**  
Cable glands nickel-plated brass  
**druckfeste Kapselung (Serie 18)**  
flameproof enclosure (Serie 18)  
**druckfeste Kapselung (Serie 18)**  
flameproof enclosure (Serie 18)  
**Progress® Messing (Ex Compact)**  
Standard  
für mehrere Kabel  
for installation of multiple cables  
**mit Klemmbacken**  
with clamps  
**mit Trompete und Klemmbacken**  
with trumpet and clamps  
**EMV**  
EMC  
**Progress® Kunststoff (GFK)**  
Standard  
Standard  
für mehrere Kabel  
for installation of multiple cables  
**Zubehör**  
Accessories  
**Reduktoren Messing**  
Reducers nickel-plated brass  
**Erweiterungen Messing**  
Expanders nickel-plated brass  
**Adapter Messing**  
Adapters nickel-plated brass  
**Verschlusschrauben**  
Locking screw

Ausführung / Version																
Kompressionstechnik Compression technology		•	•	•	•	•	•	•		•	•		-	-	-	-
Zündschutzart ... Ignition protection categories		d	d	e	e	e	e	e		e/i	e/i		e	e	e	d/e
EMV Technik / EMC technology																
Kontakthülse Contact sleeve		-	-	-	-	-	-	•		-	-		-	-	-	-
Kontaktscheibe Contact disc		-	-	-	-	-	-	•		-	-		-	-	-	-
Gewinde / Thread																
Anschlussgewinde metrisch Entry thread metric		•	•	•	•	•	•	•		•	•		-	-	-	•
Anschlussgewinde Pg Entry thread Pg		•	-	•	•	•	•	•		•	•		-	-	-	•
Anschlussgewinde NPT Entry thread NPT		•	-	-	-	-	-	-		-	-		-	-	-	-
Anschlussgewinde Gasrohr Entry thread gas pipe		•	-	-	-	-	-	-		-	-		-	-	-	-
Außengewinde metrisch - Innengewinde metrisch External thread metric - internal thread metric		-	-	-	-	-	-	-		-	-		•	•	-	-
Außengewinde Pg - Innengewinde metrisch External thread Pg - internal thread metric		-	-	-	-	-	-	-		-	-		-	-	•	-
Kurzes Anschlussgewinde Short entry thread		-	-	•	•	•	•	•		•	•		•	•	•	•
Langes Anschlussgewinde Long entry thread		•	•	•	-	-	•	-		-	-		-	-	-	-
Dichteinsatz / Sealing insert																
einteiliger Dichteinsatz One-piece sealing insert		•	•	•	•	-	-	•		•	•		-	-	-	-
zweiteiliger Dichteinsatz Two-piece sealing insert		-	-	-	-	•	•	-		-	-		-	-	-	-
für mehrere Kabel for installation of multiple cables		-	-	-	•	-	-	-		-	•		-	-	-	-
Standard-Dichteinsatz (TPE / NBR) Standard sealing insert (TPE/NBR)		•	•	•	•	•	•	•		•	•		-	-	-	-
Technische Besonderheiten / Technical features																
Zugentlastung Strain relief		•	•	•	•	•	•	•		•	•		-	-	-	-
Vibrationsschutz Vibration resistance		•	•	•	•	•	•	•		•	•		-	-	-	-
mechanische Zugentlastung mechanical strain relief		-	-	-	-	•	-	•		-	-		-	-	-	-
mit Biegeschutz und mecha- nischer Zugentlastung with bending protection and mechanical strain relief		•	-	-	-	-	•	-		-	-		-	-	-	-

# AGRO Ex Kabelverschraubungen Messing druckfeste Kapselung Ex d IIC

## AGRO Ex cable glands nickel-plated brass for flameproof enclosure Ex d IIC

Anschlussgewinde metrisch | Entry thread metric

Material: Messing vernickelt  
 Schrauben: Rostfreier Stahl A2  
 Dichtung: NBR  
 Einsatztemperatur: -40°C / +100°C  
 Schutzart: IP 68 (30 bar) / IP 69K  
 Prüfnorm: IEC EN 60079-0 / IEC EN 60079-1 / IEC EN 60079-31  
 Kategorie 2G: II 2G Ex db eb IIC  
 Kategorie 2D: II 2D Ex ta IIIC  
 Zone: Gas 1 und 2 / Staub 21 und 22  
 Zertifikat: EG-Baumusterprüfbescheinigung PTB 00 ATEX 1059  
 IECEx Zertifikat: IECEx PTB 12.0056

Material: Nickel-plated brass  
 Screws: Stainless steel A2  
 Seal: NBR  
 Temperature range: -40°C / +100°C  
 Protection class: IP 68 (30 bar) / IP 69K  
 Test standard: IEC EN 60079-0 / IEC EN 60079-1 / IEC EN 60079-31  
 Kategorie 2G: II 2G Ex db eb IIC  
 Kategorie 2D: II 2D Ex ta IIIC  
 Zone: Gas 1 and 2 / dust 21 and 22  
 Certificate: EC-type examination certificate PTB 00 ATEX 1059  
 IECEx Certificate: IECEx PTB 12.0056

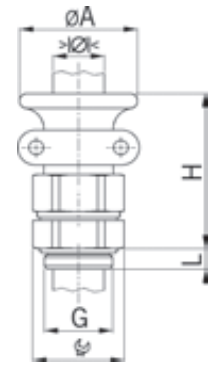

Einteiliger Dichteinsatz  
 nicht durchgehend isolierend

One-piece sealing insert  
 not overall length insulated

G	>Ø< min mm	>Ø< max mm	IEC	ØA mm	H mm	L mm	Art.-Nr.   Art. No.	
M16x1.5	7.0	9.0	20	27	57	12	1817.09.26	25
M20x1.5	9.0	11.0	24	30	57	12	1820.11.26	25
M20x1.5	11.0	13.0	26	32	57	14	1820.16.26	25
M25x1.5	13.0	16.5	32	40	67	16	1825.21.26	10
M25x1.5	16.5	20.0	36	44	67	16	1825.21.27	10
M32x1.5	20.0	24.0	46	48	78	17	1832.29.26	5
M40x1.5	24.0	28.0	46	52	78	17	1840.29.27	5
M50x1.5	28.0	32.0	55	60	85	17	1850.36.26	5
M50x1.5	32.0	36.0	55	64	85	17	1850.36.27	5
M63x1.5	36.0	40.0	70	75	88	20	1863.48.26	1
M63x1.5	40.0	44.0	70	80	88	20	1863.48.27	1



# AGRO Ex Kabelverschraubungen Messing druckfeste Kapselung Ex d IIC

## AGRO Ex cable glands nickel-plated brass for flameproof enclosure Ex d IIC

### Anschlussgewinde Pg | Entry thread Pg

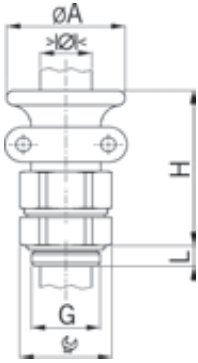

Material: Messing vernickelt  
 Schrauben: Rostfreier Stahl A2  
 Dichtung: NBR  
 Einsatztemperatur: -40°C / +100°C  
 Schutzart: IP 68 (30 bar) / IP 69K  
 Prüfnorm: IEC EN 60079-0 / IEC EN 60079-1 / IEC EN 60079-31  
 Kategorie 2G: II 2G Ex db eb IIC  
 Kategorie 2D: II 2D Ex ta IIIC  
 Zone: Gas 1 und 2 / Staub 21 und 22  
 Zertifikat: EG-Baumusterprüfbescheinigung PTB 00 ATEX 1059  
 IECEx Zertifikat: IECEx PTB 12.0056

Material: Nickel-plated brass  
 Screws: Stainless steel A2  
 Seal: NBR  
 Temperature range: -40°C / +100°C  
 Protection class: IP 68 (30 bar) / IP 69K  
 Test standard: IEC EN 60079-0 / IEC EN 60079-1 / IEC EN 60079-31  
 Category 2G: II 2G Ex db eb IIC  
 Category 2D: II 2D Ex ta IIIC  
 Zone: Gas 1 and 2 / dust 21 and 22  
 Certificate: EC-type examination certificate PTB 00 ATEX 1059  
 IECEx Certificate: IECEx PTB 12.0056



Einteiliger Dichteinsatz  
 nicht durchgehend isolierend

One-piece sealing insert  
 not overall length insulated

G	>Ø< min mm	>Ø< max mm		ØA mm	H mm	L mm	Art.-Nr.   Art. No.	
Pg 9	7.0	9.0	20	27	57	12	1809.26	25
Pg 11	9.0	11.0	24	30	57	12	1811.26	25
Pg 13	11.0	13.0	26	32	57	14	1813.26	25
Pg 16	11.0	13.0	26	32	57	14	1816.26	25
Pg 21	13.0	16.5	32	40	67	16	1821.26	10
Pg 21	16.5	20.0	36	44	67	16	1821.27	10
Pg 29	20.0	24.0	45	48	78	17	1829.26	5
Pg 29	24.0	28.0	45	52	78	17	1829.27	5
Pg 36	28.0	32.0	55	60	85	17	1836.26	5
Pg 36	32.0	36.0	55	64	85	17	1836.27	5
Pg 48	36.0	40.0	64	75	88	20	1848.48.26	1
Pg 48	40.0	44.0	64	80	88	20	1848.48.27	1

### Anschlussgewinde Gasrohr | Gas-pipe entry thread



Einteiliger Dichteinsatz  
 nicht durchgehend isolierend

One-piece sealing insert  
 not overall length insulated

G	>Ø< min mm	>Ø< max mm		ØA mm	H mm	L mm	Art.-Nr.   Art. No.	
G 3/8"	7.0	9.0	20	27	57	12	183/8G.09.26	25
G 1/2"	9.0	11.0	24	30	57	14	181/2G.11.26	25
G 1/2"	11.0	13.0	26	32	57	14	181/2G.16.26	25
G 3/4"	13.0	16.5	32	40	67	16	183/4G.21.26	10
G 3/4"	16.5	20.0	36	44	67	16	183/4G.21.27	10
G 1"	20.0	24.0	45	48	78	17	181G.29.26	5
G 1 1/4"	24.0	28.0	45	52	78	17	1811/4G.29.27	5
G 1 1/2"	28.0	32.0	55	60	85	17	1811/2G.36.26	5
G 2"	36.0	40.0	64	75	88	20	1848.26	1
G 2"	40.0	44.0	64	80	88	20	1848.27	1

# AGRO Ex Kabelverschraubungen Messing druckfeste Kapselung Ex d IIC



## AGRO Ex cable glands nickel-plated brass for flameproof enclosure Ex d IIC

### Anschlussgewinde NPT | Entry thread NPT

Material: Messing vernickelt  
 Schrauben: Rostfreier Stahl A2  
 Dichtung: NBR  
 Einsatztemperatur: -40°C / +100°C  
 Schutzart: IP 68, wenn Anschluss-  
 gewinde abgedichtet  
 Weitere Schutzart: IP 69K  
 Prüfnorm: IEC EN 60079-0 /  
 IEC EN 60079-1 /  
 IEC EN 60079-31  
 Kategorie 2G: II 2G Ex db eb IIC  
 Kategorie 2D: II 2D Ex ta IIIC  
 Zone: Gas 1 und 2 / Staub 21  
 und 22  
 Zertifikat: EG-Baumuster-  
 prüfbescheinigung  
 PTB 00 ATEX 1059  
 IECEx Zertifikat: IECEx PTB 12.0056

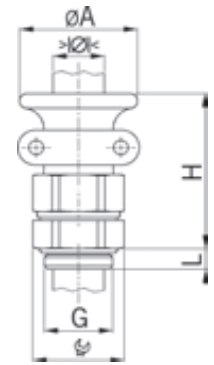
Material: Nickel-plated brass  
 Screws: Stainless steel A2  
 Seal: NBR  
 Temperature range: -40°C / +100°C  
 Protection class: IP 68, if the entry thread  
 is sealed  
 Further protection: IP 69K  
 Test standard: IEC EN 60079-0 /  
 IEC EN 60079-1 /  
 IEC EN 60079-31  
 Category 2G: II 2G Ex db eb IIC  
 Category 2D: II 2D Ex ta IIIC  
 Zone: Gas 1 and 2 / dust 21  
 and 22  
 Certificate: EC-type exami-  
 nation certificate  
 PTB 00 ATEX 1059  
 IECEx Certificate: IECEx PTB 12.0056



Einteiliger Dichteinsatz nicht durchgehend isolierend		One-piece sealing insert not overall length insulated						
G	>Ø< min mm	>Ø< max mm		ØA mm	H mm	L mm	Art.-Nr.   Art. No.	
NPT 3/8"	7.0	9.0	20	27	57	15.5	<b>183/8NPT.09.26</b>	25
NPT 1/2"	9.0	11.0	24	30	57	20	<b>181/2NPT.11.26</b>	25
NPT 1/2"	11.0	13.0	26	32	57	20	<b>181/2NPT.16.26</b>	25
NPT 3/4"	9.0	11.0	27	30	57	20	<b>183/4NPT.11.26</b>	25
NPT 3/4"	11.0	13.0	26	32	57	20	<b>183/4NPT.16.26</b>	25
NPT 3/4"	13.0	16.5	32	40	67	20	<b>183/4NPT.21.26</b>	10
NPT 1"	13.0	16.5	32/34	40	67	25	<b>181NPT.21.26</b>	10
NPT 1"	16.5	20.0	36	44	67	25	<b>181NPT.21.27</b>	10
NPT 1 1/4"	20.0	24.0	45	48	78	26	<b>1811/4NPT.29.26</b>	5
NPT 1 1/4"	24.0	28.0	45	52	78	26	<b>1811/4NPT.29.27</b>	5
NPT 1 1/2"	28.0	32.0	55	60	85	26	<b>1811/2NPT.36.26</b>	5
NPT 1 1/2"	32.0	36.0	55	64	85	26	<b>1811/2NPT.36.27</b>	5



Anschlussgewinde metrisch | Entry thread metric

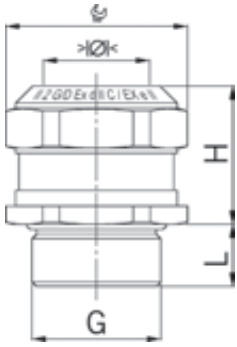

Material: Messing vernickelt  
 Dichtung: NBR  
 Einsatztemperatur: -60°C / +105°C  
 Schutzart: IP 68 (30 bar) / IP 69K  
 Prüfnorm: IEC EN 60079-0 / IEC EN 60079-1 / IEC EN 60079-7 / IEC EN 60079-31  
 Kategorie 2G: II 2G Ex db eb IIC  
 Kategorie 2D: II 2D Ex ta IIIC  
 Zone: Gas 1 und 2 / Staub 21 und 22  
 Zertifikat: EG-Baumusterprüfbescheinigung PTB 10 ATEX 1034X  
 IECEx Zertifikat: IECEx PTB 12.0055X



Material: Nickel-plated brass  
 Seal: NBR  
 Temperature range: -60°C / +105°C  
 Protection class: IP 68 (30 bar) / IP 69K  
 Test standard: IEC EN 60079-0 / IEC EN 60079-1 / IEC EN 60079-7 / IEC EN 60079-31  
 Category 2G: II 2G Ex db eb IIC  
 Category 2D: II 2D Ex ta IIIC  
 Zone: Gas 1 and 2 / dust 21 and 22  
 Certificate: EC-type-examination certificate PTB 10 ATEX 1034X  
 IECEx Certificate: IECEx PTB 12.0055X

EX Compact MS



Einteiliger Dichteinsatz  
 nicht durchgehend isolierend

One-piece sealing insert  
 not overall length insulated

G	>Ø< min mm	>Ø< max mm	 mm	H mm	L mm	Art.-Nr.   Art. No.	
M16x1.5	3.0	7.0	21	26	12	EX1126.17.070	25
M16x1.5	5.0	10.0	24	26	12	EX1126.17.100	25
M20x1.5	5.0	11.0	24	26	12	EX1126.20.110	25
M20x1.5	9.0	14.0	30	26	12	EX1126.20.140	25
M25x1.5	7.5	15.0	32	28	12	EX1126.25.150	20
M25x1.5	12.5	18.0	32	28	12	EX1126.25.180	20
M32x1.5	17.0	23.0	41	33	12	EX1126.32.230	10
M32x1.5	21.0	26.0	41	33	12	EX1126.32.260	10
M40x1.5	21.0	26.0	41	33	14	EX1126.40.260	10
M40x1.5	24.0	32.0	50	34	14	EX1126.40.320	10
M50x1.5	28.0	36.0	55	34	14	EX1126.50.360	5
M50x1.5	35.0	42.0	60	35	14	EX1126.50.420	5
M63x1.5	36.0	44.0	65	35	14	EX1126.63.440	1
M63x1.5	43.0	50.0	70	35	14	EX1126.63.500	1

Auf Anfrage lieferbar:

Available on request:

Ausführungen in Stahl A2 und A4, Anschlussgewinde NPT

Executions in steel A2 and A4, entry thread NPT



# Zubehör zu Kabelverschraubungen Messing druckfeste Kapselung Ex d IIC

## Accessories for cable glands nickel-plated brass for flameproof enclosure Ex d IIC

### Anschlussgewinde metrisch | Entry thread metric

#### Verschlusschrauben Messing druckfeste Kapselung Ex d IIC

Material:	Messing vernickelt
O-Ring :	FPM
Einsatztemperatur:	-40°C / +100°C
Schutzart:	IP 68 (30 bar)
Weitere Schutzart:	IP 69K
Prüfnorm:	IEC EN 60079-0 / IEC EN 60079-1 / IEC EN 60079-31
Kategorie 2G:	Ex d IIC
Kategorie 2D:	Ex tD A21 IP68
Zone:	Gas 1 und 2 / Staub 21 und 22
Zertifikat:	EG-Baumuster- prüfbescheinigung PTB 00 ATEX 1059
IECEx Zertifikat:	IECEx PTB 12.0056

#### Locking plugs nickel-plated brass flameproof enclosure Ex d IIC

Material:	Nickel-plated brass
O-ring :	FPM
Temperature range:	-40°C / +100°C
Protection class:	IP 68 (30 bar)
Further protection:	IP 69K
Test standard:	IEC EN 60079-0 / IEC EN 60079-1 / IEC EN 60079-31
Category 2G:	Ex d IIC
Category 2D:	Ex tD A21 IP68
Zone:	Gas 1 and 2 / dust 21 and 22
Certificate:	EC-type exami- nation certificate PTB 00 ATEX 1059
IECEx Certificate:	IECEx PTB 12.0056

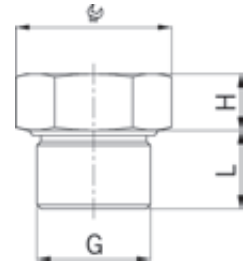

G		H mm	L mm	Art.-Nr.   Art. No.	
M12x1.5	15	5	15	8710.12	10
M16x1.5	18	6	15	8710.17	10
M20x1.5	24	8	15	8710.20	10
M25x1.5	30	10	15	8710.25	10
M32x1.5	36	12	15	8710.32	10
M40x1.5	46	12	15	8710.40	10
M50x1.5	55	12	15	8710.50	10
M63x1.5	70	12	15	8710.63	10

Lieferbar auf Anfrage Available on request

Verschlusschrauben Messing für hohe Temperaturen +200°C mit FPM O-Ring Locking plugs for high temperature applications +200°C with FPM O-ring



### Anschlussgewinde Pg | Entry thread Pg



G		H mm	L mm	Art.-Nr.   Art. No.	
Pg 7	16	6.4	10.5	8710.07	10
Pg 9	18	7.5	12	8710.09	10
Pg 11	21	8.8	12	8710.11	10
Pg 13	24	10.0	14	8710.13	10
Pg 16	27	11.5	14	8710.16	10
Pg 21	32	14.0	16	8710.21	10
Pg 29	41	17.0	17	8710.29	10
Pg 36	55	22.5	17	8710.36	10

Lieferbar auf Anfrage Available on request

Verschlusschrauben Messing für hohe Temperaturen +200°C mit FPM O-Ring Locking plugs for high temperature applications +200°C with FPM O-ring



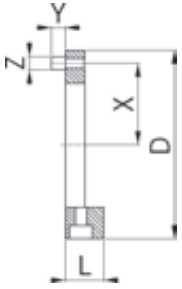

**Sicherungsringe zu Kabelverschraubungen für druckfeste Kapselung Ex d IIC**

Material: Messing vernickelt  
 Schrauben: Rostfreier Stahl A2  
 Einsatztemperatur: -60°C / +200°C  
 Einsatzbereich: Zusätzlicher Schutz gegen Selbstlockerung bei Vibrationen

**Locking rings suitable for cable glands for flameproof enclosure Ex d IIC**



Material: Nickel-plated brass  
 Screws: Stainless steel A2  
 Temperature range: -60°C / +200°C  
 Application: Additional safety against self-opening due to vibrations



Sicherungsring nach Schlüsselweite der Ex d IIC Kabelverschraubung bestimmen

The dimension of the locking ring has to match the wrench size of the Ex d IIC cable gland



 mm	D mm	L mm	X mm	Y mm	ØZ mm	Art.-Nr.   Art. No.	
20	40	13	15	5	5	1809.26.50	50
24	47	13	18	5	5	1811.26.50	50
26	50	13	20	5	5	1816.26.50	50
32	56	13	23	5	5	1821.26.50	50
36	60	13	25	5	5	1821.27.50	50
45	69	14	30	5	5	1829.26.50	50

# AGRO Kabelverschraubungen Progress® Messing erhöhte Sicherheit Ex e II

## AGRO cable glands Progress® nickel-plated brass increased safety Ex e II

### Kurzes Anschlussgewinde metrisch | Short entry thread metric

Material: Messing vernickelt  
 Dichtung: TPE  
 Einsatztemperatur: -40°C / +100°C  
 Schutzart: IP 68 (bis 10 bar)  
 Weitere Schutzart: IP 69K  
 Prüfnorm: IEC EN 60079-0 / IEC EN 60079-7  
 Kategorie 2G: Ex e II  
 Kategorie 2D: Ex tD A21 IP68  
 Zone: Gas 1 und 2 / Staub 21 und 22  
 Zertifikat: EG-Baumusterprüfbescheinigung PTB 02 ATEX 1126X  
 IECEx Zertifikat: IECEx SEV 12.0002X

Material: Nickel-plated brass  
 Seal: TPE  
 Temperature range: -40°C / +100°C  
 Protection class: IP 68 (up to 10 bar)  
 Further protection: IP 69K  
 Test standard: IEC EN 60079-0 / IEC EN 60079-7  
 Category 2G: Ex e II  
 Category 2D: Ex tD A21 IP68  
 Zone: Gas 1 and 2 / dust 21 and 22  
 Certificate: EC-type examination certificate PTB 02 ATEX 1126X  
 IECEx Certificate: IECEx SEV 12.0002X

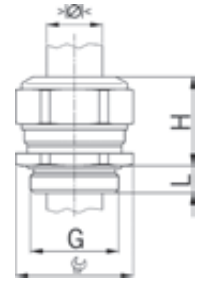

#### Progress MS EX



Einteiliger Dichteinsatz  
 nicht durchgehend isolierend

One-piece sealing insert  
 not overall length insulated

G	> Ø < min mm	> Ø < max mm	mm	H mm	L mm	i info	Art.-Nr.   Art. No.	
M8x1.25	3.0	3.5	11	14	5	1	EX1000.08.035	50
M8x1.25	4.0	5.0	11	14	5	1	EX1000.08.050	50
M10x1.5	3.0	4.0	13	15	5	1	EX1000.10.040	50
M10x1.5	4.5	6.0	13	15	5	1	EX1000.10.060	50
M12x1.5	5.0	6.5	15	17	5	-	EX1000.12.065	50
M12x1.5	6.5	8.0	15	17	5	-	EX1000.12.080	50
M16x1.5	4.5	6.0	18	20	5	-	EX1000.17.060	50
M16x1.5	6.0	8.0	18	20	5	-	EX1000.17.080	50
M20x1.5	6.0	8.0	24	21	6	-	EX1000.20.080	50
M20x1.5	8.0	11.0	24	21	6	-	EX1000.20.110	50
M25x1.5	9.5	12.5	30	25	7	-	EX1000.25.125	25
M25x1.5	12.5	16.0	30	27	7	-	EX1000.25.160	25
M32x1.5	14.0	17.0	36	28	8	-	EX1000.32.170	25
M32x1.5	17.0	21.0	36	28	8	-	EX1000.32.210	25
M40x1.5	20.0	24.0	46	31	8	-	EX1000.40.240	10
M40x1.5	24.0	28.5	46	31	8	-	EX1000.40.285	10



1 = Metrisches Regelgewinde

1 = Metric coarse-pitch thread

### Langes Anschlussgewinde metrisch | Long entry thread metric

#### Progress MS EX



Einteiliger Dichteinsatz  
 nicht durchgehend isolierend

One-piece sealing insert  
 not overall length insulated

G	> Ø < min mm	> Ø < max mm	mm	H mm	L mm	i info	Art.-Nr.   Art. No.	
M8x1.25	3.0	3.5	11	14	10	1	EX1100.08.035	50
M8x1.25	4.0	5.0	11	14	10	1	EX1100.08.050	50
M10x1.5	3.0	4.0	13	15	10	1	EX1100.10.040	50
M10x1.5	4.5	6.0	13	15	10	1	EX1100.10.060	50
M12x1.5	5.0	6.5	15	17	10	-	EX1100.12.065	50
M12x1.5	6.5	8.0	15	17	10	-	EX1100.12.080	50
M16x1.5	4.5	6.0	18	20	10	-	EX1100.17.060	50
M16x1.5	6.0	8.0	18	20	10	-	EX1100.17.080	50
M20x1.5	6.0	8.0	24	21	10	-	EX1100.20.080	50
M20x1.5	8.0	11.0	24	21	10	-	EX1100.20.110	50
M25x1.5	9.5	12.5	30	25	11	-	EX1100.25.125	25
M25x1.5	12.5	16.0	30	27	11	-	EX1100.25.160	25
M32x1.5	14.0	17.0	36	28	13	-	EX1100.32.170	25
M32x1.5	17.0	21.0	36	28	13	-	EX1100.32.210	25
M40x1.5	20.0	24.0	46	31	13	-	EX1100.40.240	10
M40x1.5	24.0	28.5	46	31	13	-	EX1100.40.285	10



1 = Metrisches Regelgewinde

1 = Metric coarse-pitch thread

# AGRO Kabelverschraubungen Progress® Messing erhöhte Sicherheit Ex e II

## AGRO cable glands Progress® nickel-plated brass increased safety Ex e II

### Kurzes Anschlussgewinde Pg | Short entry thread Pg

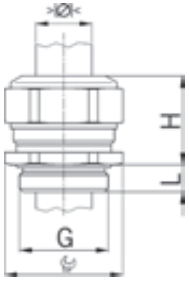

Material: Messing vernickelt  
 Dichtung: TPE  
 Einsatztemperatur: -40°C / +100°C  
 Schutzart: IP 68 (bis 10 bar)  
 Weitere Schutzart: IP 69K  
 Prüfnorm: IEC EN 60079-0 / IEC EN 60079-7  
 Kategorie 2G: Ex e II  
 Kategorie 2D: Ex tD A21 IP68  
 Zone: Gas 1 und 2 / Staub 21 und 22  
 Zertifikat: EG-Baumusterprüfbescheinigung PTB 02 ATEX 1126X  
 IECEx Zertifikat: IECEx SEV 12.0002X

Material: Nickel-plated brass  
 Seal: TPE  
 Temperature range: -40°C / +100°C  
 Protection class: IP 68 (up to 10 bar)  
 Further protection: IP 69K  
 Test standard: IEC EN 60079-0 / IEC EN 60079-7  
 Category 2G: Ex e II  
 Category 2D: Ex tD A21 IP68  
 Zone: Gas 1 and 2 / dust 21 and 22  
 Certificate: EC-type examination certificate PTB 02 ATEX 1126X  
 IECEx Certificate: IECEx SEV 12.0002X



#### Progress MS EX



Einteiliger Dichteinsatz  
 nicht durchgehend isolierend

One-piece sealing insert  
 not overall length insulated

G	> Ø < min mm	> Ø < max mm	IEC	H mm	L mm	Art.-Nr.   Art. No.	
Pg 7	5.0	6.5	15	17	6	EX1000.07.065	50
Pg 7	6.5	8.0	15	17	6	EX1000.07.080	50
Pg 9	4.5	6.0	18	20	6	EX1000.09.060	50
Pg 9	6.0	8.0	18	20	6	EX1000.09.080	50
Pg 11	4.0	5.5	21	21	6	EX1000.11.055	50
Pg 11	5.5	8.5	21	21	6	EX1000.11.085	50
Pg 13	6.0	8.0	24	21	6	EX1000.13.080	50
Pg 13	8.0	11.0	24	21	6	EX1000.13.110	50
Pg 16	6.0	8.0	24	21	6	EX1000.16.080	50
Pg 16	8.0	11.0	24	21	6	EX1000.16.110	50
Pg 21	9.5	12.5	30	25	7.5	EX1000.21.125	25
Pg 21	12.5	16.0	30	25	7.5	EX1000.21.160	25
Pg 29	16.0	19.0	38	28	8	EX1000.29.190	25
Pg 29	19.0	23.0	38	28	8	EX1000.29.230	25
Pg 36	21.5	26.0	50	32	8	EX1000.36.260	10
Pg 36	26.0	30.5	50	32	8	EX1000.36.305	10

### Langes Anschlussgewinde Pg | Long entry thread Pg



#### Progress MS EX

Einteiliger Dichteinsatz  
 nicht durchgehend isolierend

One-piece sealing insert  
 not overall length insulated

G	> Ø < min mm	> Ø < max mm	IEC	H mm	L mm	Art.-Nr.   Art. No.	
Pg 7	5.0	6.5	15	17	10	EX1100.07.065	50
Pg 7	6.5	8.0	15	17	10	EX1100.07.080	50
Pg 9	4.5	6.0	18	20	10	EX1100.09.060	50
Pg 9	6.0	8.0	18	20	10	EX1100.09.080	50
Pg 11	4.0	5.5	21	21	10	EX1100.11.055	50
Pg 11	5.5	8.5	21	21	10	EX1100.11.085	50
Pg 13	6.0	8.0	24	21	10	EX1100.13.080	50
Pg 13	8.0	11.0	24	21	10	EX1100.13.110	50
Pg 16	6.0	8.0	24	21	10	EX1100.16.080	50
Pg 16	8.0	11.0	24	21	10	EX1100.16.110	50
Pg 21	9.5	12.5	30	25	12	EX1100.21.125	25
Pg 21	12.5	16.0	30	25	12	EX1100.21.160	25
Pg 29	16.0	19.0	38	28	12	EX1100.29.190	25
Pg 29	19.0	23.0	38	28	12	EX1100.29.230	25
Pg 36	21.5	26.0	50	32	15	EX1100.36.260	10
Pg 36	26.0	30.5	50	32	15	EX1100.36.305	10

Kurzes Anschlussgewinde metrisch | Short entry thread metric

Material:	Messing vernickelt	Material:	Nickel-plated brass
Dichtung:	TPE / NBR	Seal:	TPE / NBR
Einsatztemperatur:	-40°C / +100°C	Temperature range:	-40°C / +100°C
Schutzart:	IP 68	Protection class:	IP 68
Prüfnorm:	IEC EN 60079-0 / IEC EN 60079-7	Test standard:	IEC EN 60079-0 / IEC EN 60079-7
Kategorie 2G:	Ex e II	Category 2G:	Ex e II
Kategorie 2D:	Ex tD A21 IP68	Category 2D:	Ex tD A21 IP68
Zone:	Gas 1 und 2 / Staub 21 und 22	Zone:	Gas 1 and 2 / dust 21 and 22
Zertifikat:	EG-Baumuster- prüfbescheinigung PTB 02 ATEX 1126X	Certificate:	EC-type exami- nation certificate PTB 02 ATEX 1126X
IECEx Zertifikat:	IECEx SEV 12.0002X	IECEx Certificate:	IECEx SEV 12.0002X

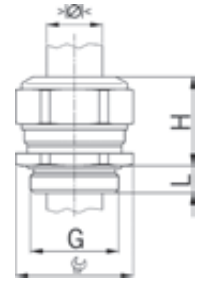

Progress MS Multi EX



Einteiliger Dichteinsatz  
nicht durchgehend isolierend

One-piece sealing insert  
not overall length insulated

G	> Ø < min mm	> Ø < max mm	⊗	Ⓜ	H mm	L mm	i info	Art.-Nr.   Art. No.	
M12x1.5	0.6	1.0	3	15	17	5	3	EX1310.12.3.010	50
M16x1.5	1.0	1.5	4	18	20	5	3	EX1310.17.4.015	50
M16x1.5	2.0	3.0	2	18	20	5	-	EX1310.17.2.030	50
M20x1.5	2.5	3.0	6	24	21	6	-	EX1310.20.6.030	50
M20x1.5	3.5	5.0	2	24	21	6	-	EX1310.20.2.050	50
M20x1.5	3.5	5.0	4	24	21	6	-	EX1310.20.4.050	50
M20x1.5	4.5	6.0	3	24	21	6	-	EX1310.20.3.060	50
M20x1.5	5.5	7.5	2	24	21	6	-	EX1310.20.2.075	50
M25x1.5	5.0	6.0	6	30	25	7	-	EX1310.25.6.060	25
M25x1.5	6.0	7.0	3	30	25	7	-	EX1310.25.3.070	25
M25x1.5	5.5	7.0	4	30	25	7	-	EX1310.25.4.070	25
M25x1.5	7.5	9.0	3	30	25	7	-	EX1310.25.3.090	25
M25x1.5	8.0	10.0	2	30	25	7	-	EX1310.25.2.100	25
M32x1.5	6.0	7.0	6	36	28	8	-	EX1310.32.6.070	25
M32x1.5	7.5	9.0	4	36	28	8	-	EX1310.32.4.090	25
M40x1.5	8.0	9.0	7	46	31	8	3	EX1310.40.7.090	10
M40x1.5	14.0	15.0	2	46	31	8	3	EX1310.40.2.150	10
M50x1.5	9.0	10.0	4	55	34	9	3	EX1310.50.4.100	10
M63x1.5	11.0	12.0	6	70	37	10	3	EX1310.63.6.120	5
M63x1.5	17.0	18.0	3	70	37	10	3	EX1310.63.3.180	5

3 = Material Dichteinsatz NBR

3 = Material sealing insert NBR





**Kurzes Anschlussgewinde Pg | Short entry thread Pg**

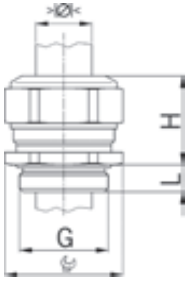

Material: Messing vernickelt  
 Dichtung: TPE / NBR  
 Einsatztemperatur: -40°C / +100°C  
 Schutzart: IP 68  
 Prüfnorm: IEC EN 60079-0 / IEC EN 60079-7  
 Kategorie 2G: Ex e II  
 Kategorie 2D: Ex tD A21 IP68  
 Zone: Gas 1 und 2 / Staub 21 und 22  
 Zertifikat: EG-Baumusterprüfbescheinigung PTB 02 ATEX 1126X  
 IECEx Zertifikat: IECEx SEV 12.0002X

Material: Nickel-plated brass  
 Seal: TPE / NBR  
 Temperature range: -40°C / +100°C  
 Protection class: IP 68  
 Test standard: IEC EN 60079-0 / IEC EN 60079-7  
 Category 2G: Ex e II  
 Category 2D: Ex tD A21 IP68  
 Zone: Gas 1 and 2 / dust 21 and 22  
 Certificate: EC-type examination certificate PTB 02 ATEX 1126X  
 IECEx Certificate: IECEx SEV 12.0002X

**Progress MS Multi EX**



Einteiliger Dichteinsatz  
 nicht durchgehend isolierend

One-piece sealing insert  
 not overall length insulated

G	> Ø < min mm	> Ø < max mm	⊗	Ⓜ	H mm	L mm	i info	Art.-Nr.   Art. No.	
Pg 9	1.0	1.5	4	18	20	6	3	EX1310.09.4.015	50
Pg 9	2.0	3.0	2	18	20	6	-	EX1310.09.2.030	50
Pg 11	2.0	3.0	3	21	21	6	3	EX1310.11.3.030	50
Pg 11	3.0	4.0	2	21	21	6	3	EX1310.11.2.040	50
Pg 11	3.5	5.0	2	21	21	6	-	EX1310.11.2.050	50
Pg 13	2.5	4.0	3	24	23	6	3	EX1310.13.3.040	50
Pg 13	3.5	5.0	2	24	23	6	-	EX1310.13.2.050	50
Pg 16	2.5	3.0	6	24	23	6	-	EX1310.16.6.030	50
Pg 16	3.0	4.0	6	24	23	6	3	EX1310.16.6.040	50
Pg 16	4.5	6.0	2	24	23	6	-	EX1310.16.2.060	50
Pg 16	4.5	6.0	3	24	23	6	-	EX1310.16.3.060	50
Pg 21	5.5	7.0	4	30	28	7	-	EX1310.21.4.070	25
Pg 21	7.5	9.0	3	30	28	7	-	EX1310.21.3.090	25
Pg 29	5.5	6.5	6	38	28	8	3	EX1310.29.6.065	25
Pg 29	8.0	9.0	3	38	28	8	3	EX1310.29.3.090	25
Pg 36	9.0	10.0	4	50	32	8	3	EX1310.36.4.100	10
Pg 36	14.0	15.0	2	50	32	8	3	EX1310.36.2.150	10
Pg 48	11.0	12.0	6	65	37	11	3	EX1310.48.6.120	10
Pg 48	17.0	18.0	3	65	37	11	3	EX1310.48.3.180	10

3 = Material Dichteinsatz NBR

3 = Material sealing insert NBR

### Kurzes Anschlussgewinde metrisch | Short entry thread metric

Material: Messing vernickelt  
 Schrauben: Rostfreier Stahl A2  
 Dichtung: TPE  
 Einsatztemperatur: -40°C / +100°C  
 Schutzart: IP 68 (bis 10 bar)  
 Weitere Schutzart: IP 69K  
 Prüfnorm: IEC EN 60079-0 / IEC EN 60079-7  
 Kategorie 2G: Ex e II  
 Kategorie 2D: Ex tD A21 IP68  
 Zone: Gas 1 und 2 / Staub 21 und 22  
 Zertifikat: EG-Baumusterprüfbescheinigung PTB 02 ATEX 1125  
 IECEx Zertifikat: IECEx SEV 12.0001

Material: Nickel-plated brass  
 Screws: Stainless steel A2  
 Seal: TPE  
 Temperature range: -40°C / +100°C  
 Protection class: IP 68 (up to 10 bar)  
 Further protection: IP 69K  
 Test standard: IEC EN 60079-0 / IEC EN 60079-7  
 Kategorie 2G: Ex e II  
 Kategorie 2D: Ex tD A21 IP68  
 Zone: Gas 1 and 2 / dust 21 and 22  
 Certificate: EC-type test certificate PTB 02 ATEX 1125  
 IECEx Certificate: IECEx SEV 12.0001

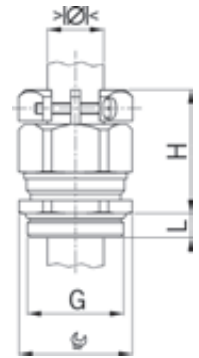

#### Progress MS KB EX



Einteiliger Dichteinsatz  
 nicht durchgehend isolierend

One-piece sealing insert  
 not overall length insulated

G	>Ø< min mm	>Ø< max mm		H mm	L mm	i info	Art.-Nr.   Art. No.	
M12x1.5	5.0	6.5	15/16	26	5	2	EX1803.12.03.065	50
M12x1.5	6.5	8.0	15/16	26	5	2	EX1803.12.03.080	50



2 = Zertifikat PTB 02 ATEX 1126X / IECEx SEV 12.0002X

2 = Certificate PTB 02 ATEX 1126X / IECEx SEV 12.0002X

Folgende EX-Kabelverschraubungen mit Klemmbacken Ex e II sind auf Anfrage erhältlich:

The following cable glands with clamps Ex e II are available on request:

- Kabelverschraubungen Messing mit langem Anschlussgewinde
- Kabelverschraubungen Messing mit hochtemperaturbeständigem FPM-Dichteinsatz (+200°C)
- Kabelverschraubungen aus rostfreiem Stahl A2 mit langem Anschlussgewinde
- Kabelverschraubungen aus rostfreiem Stahl A2 oder rostfreiem und säurebeständigem Stahl A4 mit langem Anschlussgewinde und hochtemperaturbeständigem FPM-Dichteinsatz (+200°C)

- Cable glands nickel-plated brass with long entry thread
- Cable glands nickel-plated brass with FPM sealing insert for high temperature applications (+200°C)
- Cable glands stainless steel A2 with long entry thread
- Cable glands stainless steel A2 or stainless and acid resistant steel A4 with long entry thread and FPM sealing insert for high temperature applications (+200°C)

#### Progress MS KB EX



Zweiteiliger Dichteinsatz  
 nicht durchgehend isolierend

Two-piece sealing insert  
 not overall length insulated

G	>Ø< min mm	>Ø< max mm		H mm	L mm	i info	Art.-Nr.   Art. No.	
M16x1.5	6.0	10.5	18/19	30	5	-	EX1803.17	50
M20x1.5	8.0	15.0	24	31	6	-	EX1803.20	50
M25x1.5	12.5	20.5	30	35	7	-	EX1803.25	25
M32x1.5	17.0	25.5	36	40	8	-	EX1803.32	25
M40x1.5	24.0	33.0	46	44	8	-	EX1803.40	10
M50x1.5	33.0	42.0	55	49	9	-	EX1803.50	10
M63x1.5	40.0	52.0	70	55	10	-	EX1803.63	5



Folgende EX-Kabelverschraubungen mit Klemmbacken Ex e II sind auf Anfrage erhältlich:

The following cable glands with clamps Ex e II are available on request:

- Kabelverschraubungen Messing mit langem Anschlussgewinde
- Kabelverschraubungen Messing mit hochtemperaturbeständigem FPM-Dichteinsatz (+200°C)
- Kabelverschraubungen aus rostfreiem Stahl A2 mit langem Anschlussgewinde
- Kabelverschraubungen aus rostfreiem Stahl A2 oder rostfreiem und säurebeständigem Stahl A4 mit langem Anschlussgewinde und hochtemperaturbeständigem FPM-Dichteinsatz (+200°C)

- Cable glands nickel-plated brass with long entry thread
- Cable glands nickel-plated brass with FPM sealing insert for high temperature applications (+200°C)
- Cable glands stainless steel A2 with long entry thread
- Cable glands stainless steel A2 or stainless and acid resistant steel A4 with long entry thread and FPM sealing insert for high temperature applications (+200°C)

**Kurzes Anschlussgewinde Pg | Short entry thread Pg**

Material:	Messing vernickelt	Material:	Nickel-plated brass
Schrauben:	Rostfreier Stahl A2	Screws:	Stainless steel A2
Dichtung:	TPE	Seal:	TPE
Einsatztemperatur:	-40°C / +100°C	Temperature range:	-40°C / +100°C
Schutzart:	IP 68 (bis 10 bar)	Protection class:	IP 68 (up to 10 bar)
Weitere Schutzart:	IP 69K	Further protection:	IP 69K
Prüfnorm:	IEC EN 60079-0 / IEC EN 60079-7	Test standard:	IEC EN 60079-0 / IEC EN 60079-7
Kategorie 2G:	Ex e II	Category 2G:	Ex e II
Kategorie 2D:	Ex tD A21 IP68	Category 2D:	Ex tD A21 IP68
Zone:	Gas 1 und 2 / Staub 21 und 22	Zone:	Gas 1 and 2 / dust 21 and 22
Zertifikat:	EG-Baumuster- prüfbescheinigung PTB 02 ATEX 1125	Certificate:	EC-type test certificate PTB 02 ATEX 1125
IECEX Zertifikat:	IECEX SEV 12.0001	IECEX Certificate:	IECEX SEV 12.0001





**Progress MS KB EX**



Einteiliger Dichteinsatz  
nicht durchgehend isolierend

One-piece sealing insert  
not overall length insulated

<b>G</b>	<b>&gt;∅&lt;</b> min mm	<b>&gt;∅&lt;</b> max mm	 mm	<b>H</b> mm	<b>L</b> mm	<b>i</b> info	<b>Art.-Nr.   Art. No.</b>	
<b>Pg 7</b>	5.0	6.5	15/16	26	6	2	<b>EX1803.07.03.065</b>	50
<b>Pg 7</b>	6.5	8.0	15/16	26	6	2	<b>EX1803.07.03.080</b>	50

2 = Zertifikat PTB 02 ATEX 1126X / IECEx SEV 12.0002X

2 = Certificate PTB 02 ATEX 1126X / IECEx SEV 12.0002X

Folgende EX-Kabelverschraubungen mit Klemmbacken Ex e II sind auf Anfrage erhältlich:

The following cable glands with clamps Ex e II are available on request:

- Kabelverschraubungen Messing mit langem Anschlussgewinde
- Kabelverschraubungen Messing mit hochtemperaturbeständigem FPM-Dichteinsatz (+200°C)
- Kabelverschraubungen aus rostfreiem Stahl A2 mit langem Anschlussgewinde
- Kabelverschraubungen aus rostfreiem Stahl A2 oder rostfreiem und säurebeständigem Stahl A4 mit langem Anschlussgewinde und hochtemperaturbeständigem FPM-Dichteinsatz (+200°C)

- Cable glands nickel-plated brass with long entry thread
- Cable glands nickel-plated brass with FPM sealing insert for high temperature applications (+200°C)
- Cable glands stainless steel A2 with long entry thread
- Cable glands stainless steel A2 or stainless and acid resistant steel A4 with long entry thread and FPM sealing insert for high temperature applications (+200°C)

### Kurzes Anschlussgewinde Pg | Short entry thread Pg

Material: Messing vernickelt  
 Schrauben: Rostfreier Stahl A2  
 Dichtung: TPE  
 Einsatztemperatur: -40°C / +100°C  
 Schutzart: IP 68 (bis 10 bar)  
 Weitere Schutzart: IP 69K  
 Prüfnorm: IEC EN 60079-0 / IEC EN 60079-7  
 Kategorie 2G: Ex e II  
 Kategorie 2D: Ex tD A21 IP68  
 Zone: Gas 1 und 2 / Staub 21 und 22  
 Zertifikat: EG-Baumusterprüfbescheinigung PTB 02 ATEX 1125  
 IECEx Zertifikat: IECEx SEV 12.0001

Material: Nickel-plated brass  
 Screws: Stainless steel A2  
 Seal: TPE  
 Temperature range: -40°C / +100°C  
 Protection class: IP 68 (up to 10 bar)  
 Further protection: IP 69K  
 Test standard: IEC EN 60079-0 / IEC EN 60079-7  
 Kategorie 2G: Ex e II  
 Kategorie 2D: Ex tD A21 IP68  
 Zone: Gas 1 and 2 / dust 21 and 22  
 Certificate: EC-type test certificate PTB 02 ATEX 1125  
 IECEx Certificate: IECEx SEV 12.0001

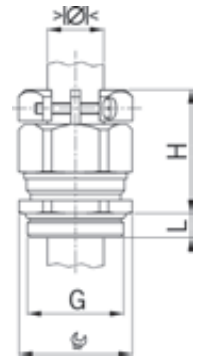

### Progress MS KB EX



Zweiteiliger Dichteinsatz  
 nicht durchgehend isolierend

Two-piece sealing insert  
 not overall length insulated

G	>Ø< min mm	>Ø< max mm	mm	H mm	L mm	i info	Art.-Nr.   Art. No.	
<b>Pg 9</b>	6.0	10.5	18/19	30	6	-	<b>EX1803.09</b>	50
<b>Pg 11</b>	5.5	12.0	21	31	6	-	<b>EX1803.11</b>	50
<b>Pg 13</b>	8.0	15.0	24	31	6	-	<b>EX1803.13</b>	50
<b>Pg 16</b>	8.0	15.0	24	31	6	-	<b>EX1803.16</b>	50
<b>Pg 21</b>	12.5	20.5	30	35	7.5	-	<b>EX1803.21</b>	25
<b>Pg 29</b>	19.0	27.5	38	40	8	-	<b>EX1803.29</b>	25
<b>Pg 36</b>	26.0	35.0	50	47	8	-	<b>EX1803.36</b>	10
<b>Pg 42</b>	33.0	42.0	55	49	10	-	<b>EX1803.42</b>	10
<b>Pg 48</b>	37.0	49.0	65	51	11	-	<b>EX1803.48</b>	5



Folgende EX-Kabelverschraubungen mit Klemmbacken Ex e II sind auf Anfrage erhältlich:

The following cable glands with clamps Ex e II are available on request:

- Kabelverschraubungen Messing mit langem Anschlussgewinde
- Kabelverschraubungen Messing mit hochtemperaturbeständigem FPM-Dichteinsatz (+200°C)
- Kabelverschraubungen aus rostfreiem Stahl A2 mit langem Anschlussgewinde
- Kabelverschraubungen aus rostfreiem Stahl A2 oder rostfreiem und säurebeständigem Stahl A4 mit langem Anschlussgewinde und hochtemperaturbeständigem FPM-Dichteinsatz (+200°C)

**Kurzes Anschlussgewinde metrisch | Short entry thread metric**

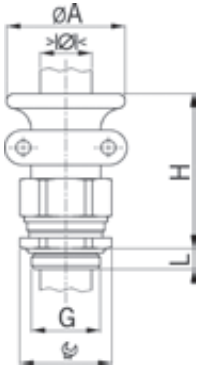

Material: Messing vernickelt  
 Schrauben: Rostfreier Stahl A2  
 Dichtung: TPE  
 Einsatztemperatur: -40°C / +100°C  
 Schutzart: IP 68 (bis 10 bar)  
 Weitere Schutzart: IP 69K  
 Prüfnorm: IEC EN 60079-0 / IEC EN 60079-7  
 Kategorie 2G: Ex e II  
 Kategorie 2D: Ex tD A21 IP68  
 Zone: Gas 1 und 2 / Staub 21 und 22  
 Zertifikat: EG-Baumusterprüfbescheinigung PTB 02 ATEX 1125  
 IECEx Zertifikat: IECEx SEV 12.0001

Material: Nickel-plated brass  
 Screws: Stainless steel A2  
 Seal: TPE  
 Temperature range: -40°C / +100°C  
 Protection class: IP 68 (up to 10 bar)  
 Further protection: IP 69K  
 Test standard: IEC EN 60079-0 / IEC EN 60079-7  
 Category 2G: Ex e II  
 Category 2D: Ex tD A21 IP68  
 Zone: Gas 1 and 2 / dust 21 and 22  
 Certificate: EC-type test certificate PTB 02 ATEX 1125  
 IECEx Certificate: IECEx SEV 12.0001

**Progress MS T+KB EX**



Zweiteiliger Dichteinsatz  
 nicht durchgehend isolierend

Two-piece sealing insert  
 not overall length insulated

G	> Ø < min mm	> Ø < max mm	 mm	ØA mm	H mm	L mm	Art.-Nr.   Art. No.	
M16x1.5	6.0	10.5	18	28	43	5	EX1801.17	50
M20x1.5	8.0	15.0	24	34	46	6	EX1801.20	50
M25x1.5	12.5	20.5	30	44	52	7	EX1801.25	25
M32x1.5	17.0	25.5	36	50	59	8	EX1801.32	10
M40x1.5	24.0	33.0	46	57	59	8	EX1801.40	5

**Auf Anfrage lieferbar:**

- Kabelverschraubungen Messing mit Trompete und Klemmbacken und hochtemperaturbeständigem FPM-Dichteinsatz (+200°C)

**Available on request:**

- Cable glands nickel-plated brass with trumpet and clamps, with FPM sealing insert for high temperature applications (+200°C)

**Langes Anschlussgewinde metrisch | Long entry thread metric**

**Progress MS T+KB EX**



Zweiteiliger Dichteinsatz  
 nicht durchgehend isolierend

Two-piece sealing insert  
 not overall length insulated

G	> Ø < min mm	> Ø < max mm	 mm	ØA mm	H mm	L mm	Art.-Nr.   Art. No.	
M16x1.5	6.0	10.5	18	28	43	10	EX1811.17	50
M20x1.5	8.0	15.0	24	34	46	10	EX1811.20	50
M25x1.5	12.5	20.5	30	44	52	11	EX1811.25	25
M32x1.5	17.0	25.5	36	50	59	13	EX1811.32	10
M40x1.5	24.0	33.0	46	57	59	13	EX1811.40	5

**Auf Anfrage lieferbar:**

- Kabelverschraubungen Messing mit Trompete und Klemmbacken und hochtemperaturbeständigem FPM-Dichteinsatz (+200°C)

**Available on request:**

- Cable glands nickel-plated brass with trumpet and clamps, with FPM sealing insert for high temperature applications (+200°C)

Kurzes Anschlussgewinde Pg | Short entry thread Pg

Material: Messing vernickelt  
 Schrauben: Rostfreier Stahl A2  
 Dichtung: TPE  
 Einsatztemperatur: -40°C / +100°C  
 Schutzart: IP 68 (bis 10 bar)  
 Weitere Schutzart: IP 69K  
 Prüfnorm: IEC EN 60079-0 / IEC EN 60079-7  
 Kategorie 2G: Ex e II  
 Kategorie 2D: Ex tD A21 IP68  
 Zone: Gas 1 und 2 / Staub 21 und 22  
 Zertifikat: EG-Baumusterprüfbescheinigung PTB 02 ATEX 1125  
 IECEx Zertifikat: IECEx SEV 12.0001

Material: Nickel-plated brass  
 Screws: Stainless steel A2  
 Seal: TPE  
 Temperature range: -40°C / +100°C  
 Protection class: IP 68 (up to 10 bar)  
 Further protection: IP 69K  
 Test standard: IEC EN 60079-0 / IEC EN 60079-7  
 Kategorie 2G: Ex e II  
 Kategorie 2D: Ex tD A21 IP68  
 Zone: Gas 1 and 2 / dust 21 and 22  
 Certificate: EC-type test certificate PTB 02 ATEX 1125  
 IECEx Certificate: IECEx SEV 12.0001

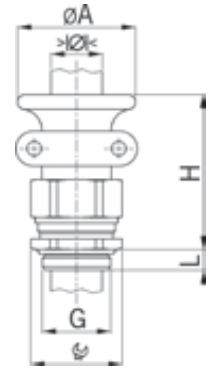

Progress MS T+KB EX



Zweiteiliger Dichteinsatz  
 nicht durchgehend isolierend

Two-piece sealing insert  
 not overall length insulated

G	> Ø < min mm	> Ø < max mm	mm	ØA mm	H mm	L mm	Art.-Nr.   Art. No.	
Pg 9	6.0	10.5	18	28	43	6	EX1801.09	50
Pg 11	5.5	12.0	21	30	43	6	EX1801.11	50
Pg 13	8.0	15.0	24	34	46	6	EX1801.13	50
Pg 16	8.0	15.0	24	34	46	6	EX1801.16	50
Pg 21	12.5	20.5	30	44	52	7.5	EX1801.21	25
Pg 29	19.0	27.5	38	50	59	8	EX1801.29	10



Auf Anfrage lieferbar:

Available on request:

- Kabelverschraubungen Messing mit Trompete und Klemmbacken und hochtemperaturbeständigem FPM-Dichteinsatz (+200°C)

- Cable glands nickel-plated brass with trumpet and clamps, with FPM sealing insert for high temperature applications (+200°C)

Langes Anschlussgewinde Pg | Long entry thread Pg

Progress MS T+KB EX



Zweiteiliger Dichteinsatz  
 nicht durchgehend isolierend

Two-piece sealing insert  
 not overall length insulated

G	> Ø < min mm	> Ø < max mm	mm	ØA mm	H mm	L mm	Art.-Nr.   Art. No.	
Pg 9	6.0	10.5	18	28	43	10	EX1811.09	50
Pg 11	5.5	12.0	21	30	43	10	EX1811.11	50
Pg 13	8.0	15.0	24	34	46	10	EX1811.13	50
Pg 16	8.0	15.0	24	34	46	10	EX1811.16	50
Pg 21	12.5	20.5	30	44	52	12	EX1811.21	25
Pg 29	19.0	27.5	38	50	59	12	EX1811.29	10



Auf Anfrage lieferbar:

Available on request:

- Kabelverschraubungen Messing mit Trompete und Klemmbacken und hochtemperaturbeständigem FPM-Dichteinsatz (+200°C)

- Cable glands nickel-plated brass with trumpet and clamps, with FPM sealing insert for high temperature applications (+200°C)



**Kurzes Anschlussgewinde metrisch | Short entry thread metric**

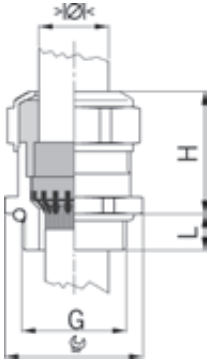

Material: Messing vernickelt  
 Dichtung: TPE  
 O-Ring : NBR  
 Einsatztemperatur: -40°C / +100°C  
 Schutzart: IP 68 (bis 10 bar)  
 Weitere Schutzart: IP 69K  
 Prüfnorm: IEC EN 60079-0 / IEC EN 60079-7  
 Kategorie 2G: Ex e II  
 Kategorie 2D: Ex tD A21 IP68  
 Zone: Gas 1 und 2 / Staub 21 und 22  
 Zertifikat: EG-Baumusterprüfbescheinigung PTB 02 ATEX 1126X  
 IECEx Zertifikat: IECEx SEV 12.0002X  
 Eigenschaften: Für zeitsparende Montage von partiell abisolierten sowie durchgehend geschirmten Kabeln

Material: Nickel-plated brass  
 Seal: TPE  
 O-ring : NBR  
 Temperature range: -40°C / +100°C  
 Protection class: IP 68 (up to 10 bar)  
 Further protection: IP 69K  
 Test standard: IEC EN 60079-0 / IEC EN 60079-7  
 Category 2G: Ex e II  
 Category 2D: Ex tD A21 IP68  
 Zone: Gas 1 and 2 / dust 21 and 22  
 Certificate: EC-type examination certificate PTB 02 ATEX 1126X  
 IECEx Certificate: IECEx SEV 12.0002X  
 Properties: For a quick installation of partially dismantled cables as well as thoroughly shielded cables

**Progress MS EMC Rapid EX**



Einteiliger Dichteinsatz  
 nicht durchgehend isolierend

One-piece sealing insert  
 not overall length insulated

G	> Ø < min mm	> Ø < max mm	EMC	H mm	L mm	Art.-Nr.   Art. No.	☐
M12x1.5	4.5	6.0	15	20	5	EX1081.12.060	50
M12x1.5	6.0	7.5	15	20	5	EX1081.12.075	50
M16x1.5	6.0	8.0	18	23	5	EX1081.17.080	50
M16x1.5	8.0	10.0	18	25	5	EX1081.17.100	50
M20x1.5	8.0	11.0	24	25	6	EX1081.20.110	50
M20x1.5	11.0	14.0	24	27	6	EX1081.20.140	50
M25x1.5	13.0	16.0	30	30	7	EX1081.25.160	25
M25x1.5	16.0	19.0	30	33	7	EX1081.25.190	25
M32x1.5	18.0	21.0	36	32	8	EX1081.32.210	25

Langes Anschlussgewinde auf Anfrage

Long entry thread available on request

**Kurzes Anschlussgewinde Pg | Short entry thread Pg**



**Progress MS EMC Rapid EX**

Einteiliger Dichteinsatz  
 nicht durchgehend isolierend

One-piece sealing insert  
 not overall length insulated

G	> Ø < min mm	> Ø < max mm	EMC	H mm	L mm	Art.-Nr.   Art. No.	☐
Pg 7	4.5	6.0	15	20	6	EX1081.07.060	50
Pg 7	6.0	7.5	15	20	6	EX1081.07.075	50
Pg 9	6.0	8.0	18	23	6	EX1081.09.080	50
Pg 9	8.0	10.0	18	25	6	EX1081.09.100	50
Pg 11	5.5	8.5	21	25	6	EX1081.11.085	50
Pg 11	8.5	12.0	21	25	6	EX1081.11.120	50
Pg 13	8.0	11.0	24	25	6	EX1081.13.110	50
Pg 13	12.5	14.0	24	27	6	EX1081.13.140	50
Pg 16	8.0	11.0	24	24	6	EX1081.16.110	50
Pg 16	12.5	14.0	24	27	6	EX1081.16.140	50
Pg 21	13.0	16.0	30	30	7	EX1081.21.160	25
Pg 21	17.0	19.0	30	33	7	EX1081.21.190	25
Pg 29	19.0	23.0	38	33	8	EX1081.29.230	25
Pg 29	23.0	25.5	38	32	8	EX1081.29.255	25

Langes Anschlussgewinde auf Anfrage

Long entry thread available on request

Kurzes Anschlussgewinde metrisch | Short entry thread metric

Material: Messing vernickelt  
 Dichtung: TPE  
 O-Ring : NBR  
 Einsatztemperatur: -40°C / +100°C  
 Schutzart: IP 68 (bis 10 bar)  
 Weitere Schutzart: IP 69K  
 Prüfnorm: IEC EN 60079-0 / IEC EN 60079-7  
 Kategorie 2G: Ex e II  
 Kategorie 2D: Ex tD A21 IP68  
 Zone: Gas 1 und 2 / Staub 21 und 22  
 Zertifikat: EG-Baumusterprüfbescheinigung PTB 02 ATEX 1126X  
 IECEx Zertifikat: IECEx SEV 12.0002X  
 Eigenschaften: Sehr guter Schirmkontakt über die Kontakthülse bei in der Kabelverschraubung endendem Schirmgeflecht

Material: Nickel-plated brass  
 Seal: TPE  
 O-ring : NBR  
 Temperature range: -40°C / +100°C  
 Protection class: IP 68 (up to 10 bar)  
 Further protection: IP 69K  
 Test standard: IEC EN 60079-0 / IEC EN 60079-7  
 Category 2G: Ex e II  
 Category 2D: Ex tD A21 IP68  
 Zone: Gas 1 and 2 / dust 21 and 22  
 Certificate: EC-type examination certificate PTB 02 ATEX 1126X  
 IECEx Certificate: IECEx SEV 12.0002X  
 Properties: Excellent shield contact through the contact sleeve with the braided shield terminating in the screwed cable gland

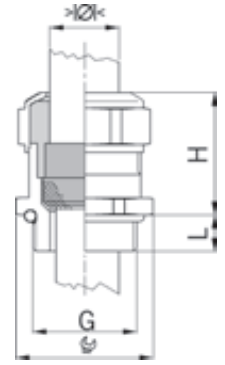

Progress MS EMC EX



Einteiliger Dichteinsatz  
 nicht durchgehend isolierend

One-piece sealing insert  
 not overall length insulated

G	>Ø< min mm	>Ø< max mm		H mm	L mm	i info	Art.-Nr.   Art. No.	
M8x1.25	2.5	3.5	11	15	5	1	EX1080.08.035	50
M8x1.25	3.0	4.0	11	15	5	1	EX1080.08.040	50
M10x1.5	3.0	4.0	13	16	5	1	EX1080.10.040	50
M10x1.5	4.0	6.0	13	16	5	1	EX1080.10.060	50
M12x1.5	4.5	6.0	15	20	5	-	EX1080.12.060	50
M12x1.5	6.0	7.5	15	20	5	-	EX1080.12.075	50
M16x1.5	6.0	8.0	18	23	5	-	EX1080.17.080	50
M16x1.5	8.0	10.0	18	25	5	-	EX1080.17.100	50
M20x1.5	8.0	11.0	24	25	6	-	EX1080.20.110	50
M20x1.5	12.5	14.0	24	27	6	-	EX1080.20.140	50
M25x1.5	13.0	16.0	30	30	7	-	EX1080.25.160	25
M25x1.5	17.0	19.0	30	33	7	-	EX1080.25.190	25
M32x1.5	17.0	21.0	36	32	8	-	EX1080.32.210	25
M40x1.5	24.0	28.5	46	34	8	-	EX1080.40.285	10



1 = Metrisches Regelgewinde

1 = Metric coarse-pitch thread

Langes Anschlussgewinde auf Anfrage

Long entry thread available on request

**Kurzes Anschlussgewinde Pg | Short entry thread Pg**

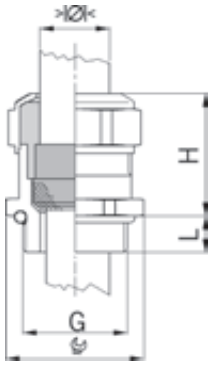

Material: Messing vernickelt  
 Dichtung: TPE  
 O-Ring : NBR  
 Einsatztemperatur: -40°C / +100°C  
 Schutzart: IP 68 (bis 10 bar)  
 Weitere Schutzart: IP 69K  
 Prüfnorm: IEC EN 60079-0 / IEC EN 60079-7  
 Kategorie 2G: Ex e II  
 Kategorie 2D: Ex tD A21 IP68  
 Zone: Gas 1 und 2 / Staub 21 und 22  
 Zertifikat: EG-Baumusterprüfbescheinigung PTB 02 ATEX 1126X  
 IECEx Zertifikat: IECEx SEV 12.0002X  
 Eigenschaften: Sehr guter Schirmkontakt über die Kontakthülse bei in der Kabelverschraubung endendem Schirmgeflecht

Material: Nickel-plated brass  
 Seal: TPE  
 O-ring : NBR  
 Temperature range: -40°C / +100°C  
 Protection class: IP 68 (up to 10 bar)  
 Further protection: IP 69K  
 Test standard: IEC EN 60079-0 / IEC EN 60079-7  
 Category 2G: Ex e II  
 Category 2D: Ex tD A21 IP68  
 Zone: Gas 1 and 2 / dust 21 and 22  
 Certificate: EC-type examination certificate PTB 02 ATEX 1126X  
 IECEx Certificate: IECEx SEV 12.0002X  
 Properties: Excellent shield contact through the contact sleeve with the braided shield terminating in the screwed cable gland

**Progress MS EMC EX**



Einteiliger Dichteinsatz  
 nicht durchgehend isolierend

One-piece sealing insert  
 not overall length insulated

G	>Ø< min mm	>Ø< max mm		H mm	L mm	Art.-Nr.   Art. No.	
Pg 7	4.5	6.0	15	20	6	EX1080.07.060	50
Pg 7	6.0	7.5	15	20	6	EX1080.07.075	50
Pg 9	6.0	8.0	18	23	6	EX1080.09.080	50
Pg 9	8.0	10.0	18	25	6	EX1080.09.100	50
Pg 11	5.5	8.5	21	23	6	EX1080.11.085	50
Pg 11	9.5	12.0	21	23	6	EX1080.11.120	50
Pg 13	8.0	11.0	24	25	6	EX1080.13.110	50
Pg 13	12.5	14.0	24	27	6	EX1080.13.140	50
Pg 16	8.0	11.0	24	24	6	EX1080.16.110	50
Pg 16	12.5	14.0	24	27	6	EX1080.16.140	50
Pg 21	13.0	16.0	30	30	7.5	EX1080.21.160	25
Pg 21	17.0	19.0	30	33	7.5	EX1080.21.190	25
Pg 29	19.0	23.0	38	33	8	EX1080.29.230	25
Pg 29	24.0	25.5	38	32	8	EX1080.29.255	25
Pg 36	25.0	30.5	50	36	8	EX1080.36.305	10

Langes Anschlussgewinde auf Anfrage

Long entry thread available on request

Kurzes Anschlussgewinde metrisch | Short entry thread metric

Material: Messing vernickelt  
 Schrauben: Rostfreier Stahl A2  
 Dichtung: TPE  
 Einsatztemperatur: -40°C / +100°C  
 Schutzart: IP 68 (bis 10 bar)  
 Weitere Schutzart: IP 69K  
 Prüfnorm: IEC EN 60079-0 / IEC EN 60079-7  
 Kategorie 2G: Ex e II  
 Kategorie 2D: Ex tD A21 IP68  
 Zone: Gas 1 und 2 / Staub 21 und 22  
 Zertifikat: EG-Baumusterprüfbescheinigung PTB 02 ATEX 1125  
 IECEx Zertifikat: IECEx SEV 12.0001

Material: Nickel-plated brass  
 Screws: Stainless steel A2  
 Seal: TPE  
 Temperature range: -40°C / +100°C  
 Protection class: IP 68 (up to 10 bar)  
 Further protection: IP 69K  
 Test standard: IEC EN 60079-0 / IEC EN 60079-7  
 Kategorie 2G: Ex e II  
 Kategorie 2D: Ex tD A21 IP68  
 Zone: Gas 1 and 2 / dust 21 and 22  
 Certificate: EC-type test certificate PTB 02 ATEX 1125  
 IECEx Certificate: IECEx SEV 12.0001

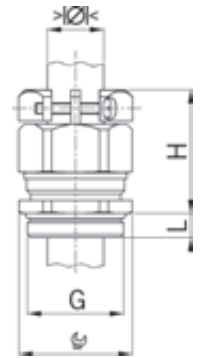

Progress MS EMC KB EX



Einteiliger Dichteinsatz  
 nicht durchgehend isolierend

One-piece sealing insert  
 not overall length insulated

G	> Ø < min mm	> Ø < max mm	 mm	H mm	L mm	i info	Art.-Nr.   Art. No.	
M12x1.5	4.5	6.0	15/16	26	5	1	EX1803.80.12.060	50
M12x1.5	6.0	7.5	15/16	26	5	1	EX1803.80.12.075	50
M16x1.5	6.0	8.0	18/19	30	5	-	EX1803.80.17.080	50
M16x1.5	8.0	10.0	18/19	30	5	-	EX1803.80.17.100	50
M20x1.5	8.0	11.0	24	31	6	-	EX1803.80.20.110	50
M20x1.5	11.0	14.0	24	31	6	-	EX1803.80.20.140	50
M25x1.5	13.0	16.0	30	35	7	-	EX1803.80.25.160	25
M25x1.5	16.0	19.0	30	35	7	-	EX1803.80.25.190	25
M32x1.5	18.0	21.0	36	40	8	-	EX1803.80.32.210	25
M32x1.5	21.0	25.0	36	40	8	-	EX1803.80.32.250	25
M40x1.5	24.0	28.5	46	44	8	-	EX1803.80.40.285	10
M40x1.5	28.5	32.0	46	44	8	-	EX1803.80.40.320	10
M50x1.5	33.0	37.0	55	49	9	-	EX1803.80.50.370	10
M50x1.5	37.0	41.0	55	49	9	-	EX1803.80.50.410	10
M63x1.5	40.0	46.0	70	55	10	-	EX1803.80.63.460	5
M63x1.5	46.0	50.0	70	55	10	-	EX1803.80.63.500	5



1 = Zertifikat PTB 02 ATEX 1126X / IECEx SEV 12.0002X

1 = Certificate PTB 02 ATEX 1126X / IECEx SEV 12.0002X

Langes Anschlussgewinde auf Anfrage

Long entry thread available on request

**Kurzes Anschlussgewinde Pg | Short entry thread Pg**

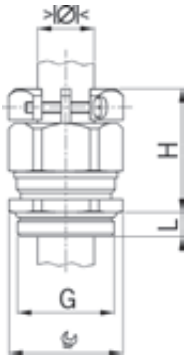

Material: Messing vernickelt  
 Schrauben: Rostfreier Stahl A2  
 Dichtung: TPE  
 Einsatztemperatur: -40°C / +100°C  
 Schutzart: IP 68 (bis 10 bar)  
 Weitere Schutzart: IP 69K  
 Prüfnorm: IEC EN 60079-0 / IEC EN 60079-7  
 Kategorie 2G: Ex e II  
 Kategorie 2D: Ex tD A21 IP68  
 Zone: Gas 1 und 2 / Staub 21 und 22  
 Zertifikat: EG-Baumusterprüfbescheinigung PTB 02 ATEX 1125  
 IECEx Zertifikat: IECEx SEV 12.0001

Material: Nickel-plated brass  
 Screws: Stainless steel A2  
 Seal: TPE  
 Temperature range: -40°C / +100°C  
 Protection class: IP 68 (up to 10 bar)  
 Further protection: IP 69K  
 Test standard: IEC EN 60079-0 / IEC EN 60079-7  
 Kategorie 2G: Ex e II  
 Kategorie 2D: Ex tD A21 IP68  
 Zone: Gas 1 and 2 / dust 21 and 22  
 Certificate: EC-type test certificate PTB 02 ATEX 1125  
 IECEx Certificate: IECEx SEV 12.0001

**Progress MS EMC KB EX**



Einteiliger Dichteinsatz  
 nicht durchgehend isolierend

One-piece sealing insert  
 not overall length insulated

G	> Ø < min mm	> Ø < max mm	mm	H mm	L mm	i info	Art.-Nr.   Art. No.	
Pg 7	4.5	6.0	15/16	26	6	1	EX1803.80.07.060	50
Pg 7	6.0	7.5	15/16	26	6	1	EX1803.80.07.075	50
Pg 9	6.0	8.0	18/19	30	6	-	EX1803.80.09.080	50
Pg 9	8.0	10.0	18/19	30	6	-	EX1803.80.09.100	50
Pg 11	5.5	8.5	21	31	6	-	EX1803.80.11.085	50
Pg 11	8.5	12.0	21	31	6	-	EX1803.80.11.120	50
Pg 13	8.0	11.0	24	31	6	-	EX1803.80.13.110	50
Pg 13	11.0	14.0	24	31	6	-	EX1803.80.13.140	50
Pg 16	8.0	11.0	24	31	6	-	EX1803.80.16.110	50
Pg 16	11.0	14.0	24	31	6	-	EX1803.80.16.140	50
Pg 21	13.0	16.0	30	35	7.5	-	EX1803.80.21.160	25
Pg 21	16.0	19.0	30	35	7.5	-	EX1803.80.21.190	25
Pg 29	19.0	23.0	38	40	8	-	EX1803.80.29.230	25
Pg 29	23.0	25.5	38	40	8	-	EX1803.80.29.255	25
Pg 36	25.0	30.5	50	47	8	-	EX1803.80.36.305	10
Pg 36	30.5	35.0	50	47	8	-	EX1803.80.36.350	10
Pg 42	33.0	37.0	55	49	10	-	EX1803.80.42.370	10
Pg 42	37.0	41.0	55	49	10	-	EX1803.80.42.410	10
Pg 48	39.0	43.0	65	51	11	-	EX1803.80.48.430	5
Pg 48	43.0	46.5	65	51	11	-	EX1803.80.48.465	5

1 = Zertifikat PTB 02 ATEX 1126X / IECEx SEV 12.0002X

1 = Certificate PTB 02 ATEX 1126X / IECEx SEV 12.0002X

Langes Anschlussgewinde auf Anfrage

Long entry thread available on request

# AGRO Kombi-Schlauchverschraubungen Progress® Messing erhöhte Sicherheit Ex e II

## AGRO combination conduit glands Progress® nickel-plated brass increased safety Ex e II

### Kurzes Anschlussgewinde metrisch | Short entry thread metric

Material: Messing vernickelt  
 Dichtung: TPE / NBR  
 Einsatztemperatur: -40°C / +100°C  
 Schutzart: IP 66 / IP 68  
 Prüfnorm: IEC EN 60079-0 / IEC EN 60079-7  
 Kategorie 2G: Ex e II  
 Kategorie 2D: Ex tD A21  
 Zone: Gas 1 und 2 / Staub 21 und 22  
 Zertifikat: EG-Baumusterprüfbescheinigung PTB 11 ATEX 1022X  
 IECEx Zertifikat: IECEx SEV 12.0004X

Material: Nickel-plated brass  
 Seal: TPE / NBR  
 Temperature range: -40°C / +100°C  
 Protection class: IP 66 / IP 68  
 Test standard: IEC EN 60079-0 / IEC EN 60079-7  
 Kategorie 2G: Ex e II  
 Kategorie 2D: Ex tD A21  
 Zone: Gas 1 and 2 / dust 21 and 22  
 Certificate: EC-type examination certificate PTB 11 ATEX 1022X  
 IECEx Certificate: IECEx SEV 12.0004X

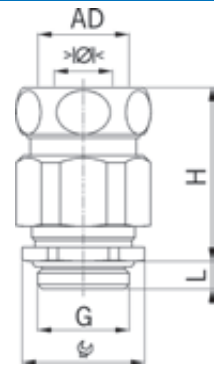



### Progress MS Kombi EX



Einteiliger Dichteinsatz  
 nicht durchgehend isolierend

One-piece sealing insert  
 not overall length insulated

G	AD mm	>Ø< min mm	>Ø< max mm	 mm	H mm	L mm	Art.-Nr.   Art. No.	
M12x1.5	10	4.0	6.5	15/17	33	5	EX1700.12.10.065	50
M16x1.5	14	4.5	6.0	18/21	38	5	EX1700.17.14.060	50
M16x1.5	14	6.0	8.0	18/21	38	5	EX1700.17.14.080	50
M16x1.5	14	8.5	10.5	18/21	38	5	EX1700.17.14.105	50
M20x1.5	17	6.5	8.0	24/25	38	6	EX1700.20.17.080	25
M20x1.5	17	9.5	11.0	24/25	38	6	EX1700.20.17.110	25
M20x1.5	19	6.5	8.0	24/27	39	6	EX1700.20.19.080	25
M20x1.5	19	9.5	11.0	24/27	39	6	EX1700.20.19.110	25
M20x1.5	19	12.0	15.0	24/27	39	6	EX1700.20.19.150	25
M20x1.5	21	6.5	8.0	24/29	39	6	EX1700.20.21.080	25
M20x1.5	21	9.5	11.0	24/29	39	6	EX1700.20.21.110	25
M20x1.5	21	12.0	15.0	24/29	39	6	EX1700.20.21.150	25
M25x1.5	21	10.5	12.5	30/29	43	7	EX1700.25.21.125	25
M25x1.5	21	13.0	16.0	30/29	43	7	EX1700.25.21.160	25
M25x1.5	27	10.5	12.5	30/36	50	7	EX1700.25.27.125	25
M25x1.5	27	13.0	16.0	30/36	50	7	EX1700.25.27.160	25
M25x1.5	27	17.0	20.5	30/36	50	7	EX1700.25.27.205	25
M32x1.5	27	19.0	21.0	36/36	52	8	EX1700.32.27.210	25
M40x1.5	36	25.0	28.5	45/45	56	8	EX1700.40.36.285	10
M50x1.5	45	35.0	37.0	55/54	60	9	EX1700.50.45.370	10
M63x1.5	56	44.0	46.0	70/66	67	10	EX1700.63.56.460	5



Langes Anschlussgewinde auf Anfrage

Long entry thread available on request

Je nach Schlauchtyp muss die passende Stabilisierungshülse separat bestellt werden.

Depending on the type of conduit, the stabilising bush must be ordered separately.

**Achtung:** Es dürfen nur metallische oder metallisch umflochtene Schutzschläuche verwendet werden !

**Warning:** Only metallic conduits or conduits with metallic braiding may be applied !



# AGRO Kabelverschraubungen Progress® Kunststoff GFK erhöhte Sicherheit Ex e II

## AGRO synthetic cable glands Progress® GFK increased safety Ex e II

### Anschlussgewinde metrisch | Entry thread metric

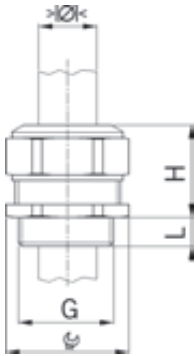

Material: Polyamid  
glasfaserverstärkt

Eigenschaften: halogenfrei

Dichtung: TPE / NBR

Einsatztemperatur: -20°C / +85°C

Schutzart: IP 68

Prüfnorm: IEC EN 60079-0 /  
IEC EN 60079-7

Kategorie 2G: Ex e II

Kategorie 2D: Ex tD A21 IP68

Zone: Gas 1 und 2 / Staub 21  
und 22

Zertifikat: EG-Baumuster-  
prüfbescheinigung  
PTB 02 ATEX 1126X

IECEx Zertifikat: IECEx SEV 12.0002X

Material: Polyamide glass fiber  
reinforced

Properties: Halogen-free

Seal: TPE / NBR

Temperature range: -20°C / +85°C

Protection class: IP 68

Test standard: IEC EN 60079-0 /  
IEC EN 60079-7

Category 2G: Ex e II

Category 2D: Ex tD A21 IP68

Zone: Gas 1 and 2 / dust 21  
and 22

Certificate: EC-type exami-  
nation certificate  
PTB 02 ATEX 1126X

IECEx Certificate: IECEx SEV 12.0002X

### Progress GFK EX



Hellgrau RAL 7035  
Einteiliger Dichteinsatz

Light grey RAL 7035  
One-piece sealing insert

G	>Ø< min mm	>Ø< max mm		H mm	L mm	i info	Art.-Nr.   Art. No.	
M16x1.5	4.5	6.0	21	26	12	-	EX1571.17.060	50
M16x1.5	6.0	8.0	21	26	12	-	EX1571.17.080	50
M20x1.5	6.0	8.0	27	28	13	-	EX1571.20.080	50
M20x1.5	8.0	11.0	27	28	13	-	EX1571.20.110	50
M25x1.5	9.5	12.5	34	33	13	-	EX1571.25.125	25
M25x1.5	12.5	16.0	34	33	13	-	EX1571.25.160	25
M25x1.5	16.0	19.0	34	33	13	-	EX1571.25.190	25
M25x1.5	19.0	20.5	34	33	13	-	EX1571.25.205	25
M32x1.5	20.0	21.0	41	35	15	-	EX1571.32.210	25
M32x1.5	21.0	22.0	41	35	15	3	EX1571.32.220	25
M32x1.5	22.0	23.0	41	35	15	3	EX1571.32.230	25
M32x1.5	23.0	25.5	41	35	15	-	EX1571.32.255	25
M40x1.5	25.5	27.0	50	40	15	3	EX1571.40.270	10
M40x1.5	27.0	28.5	50	40	15	-	EX1571.40.285	10
M40x1.5	28.5	30.0	50	40	15	3	EX1571.40.300	10
M40x1.5	30.0	33.0	50	40	15	-	EX1571.40.330	10
M50x1.5	33.0	35.0	60	42	16	3	EX1571.50.350	10
M50x1.5	35.0	37.0	60	42	16	-	EX1571.50.370	10
M50x1.5	37.0	39.0	60	42	16	3	EX1571.50.390	10
M50x1.5	39.0	42.0	60	42	16	-	EX1571.50.420	10
M63x1.5	42.0	44.0	75	48	16	3	EX1571.63.440	5
M63x1.5	44.0	46.0	75	48	16	-	EX1571.63.460	5
M63x1.5	46.0	48.0	75	48	16	3	EX1571.63.480	5
M63x1.5	48.0	52.0	75	48	16	-	EX1571.63.520	5

3 = Material Dichteinsatz NBR

3 = Material sealing insert NBR

# AGRO Kabelverschraubungen Progress® Kunststoff GFK erhöhte Sicherheit Ex e II

## AGRO synthetic cable glands Progress® GFK increased safety Ex e II

Anschlussgewinde metrisch | Entry thread metric

Material: Polyamid  
glasfaserverstärkt

Eigenschaften: halogenfrei

Dichtung: TPE / NBR

Einsatztemperatur: -20°C / +85°C

Schutzart: IP 68

Prüfnorm: IEC EN 60079-0 /  
IEC EN 60079-7

Kategorie 2G: Ex e II

Kategorie 2D: Ex tD A21 IP68

Zone: Gas 1 und 2 / Staub 21  
und 22

Zertifikat: EG-Baumuster-  
prüfbescheinigung  
PTB 02 ATEX 1126X

IECEX Zertifikat: IECEX SEV 12.0002X

Material: Polyamide glass fiber  
reinforced

Properties: Halogen-free

Seal: TPE / NBR

Temperature range: -20°C / +85°C

Protection class: IP 68

Test standard: IEC EN 60079-0 /  
IEC EN 60079-7

Category 2G: Ex e II

Category 2D: Ex tD A21 IP68

Zone: Gas 1 and 2 / dust 21  
and 22

Certificate: EC-type exami-  
nation certificate  
PTB 02 ATEX 1126X

IECEX Certificate: IECEX SEV 12.0002X

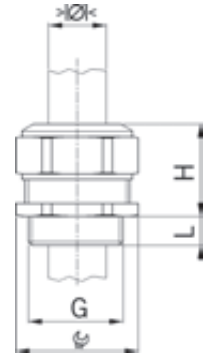

### Progress GFK EX



Schwarz RAL 9005  
Einteiliger Dichteinsatz

Black RAL 9005  
One-piece sealing insert

G	>Ø< min mm	>Ø< max mm		H mm	L mm	i info	Art.-Nr.   Art. No.	
M16x1.5	4.5	6.0	21	26	12	-	EX1540.17.060	50
M16x1.5	6.0	8.0	21	26	12	-	EX1540.17.080	50
M20x1.5	6.0	8.0	27	28	13	-	EX1540.20.080	50
M20x1.5	8.0	11.0	27	28	13	-	EX1540.20.110	50
M25x1.5	9.5	12.5	34	33	13	-	EX1540.25.125	25
M25x1.5	12.5	16.0	34	33	13	-	EX1540.25.160	25
M25x1.5	16.0	19.0	34	33	13	-	EX1540.25.190	25
M25x1.5	19.0	20.5	34	33	13	-	EX1540.25.205	25
M32x1.5	20.0	21.0	41	35	15	-	EX1540.32.210	25
M32x1.5	21.0	22.0	41	35	15	3	EX1540.32.220	25
M32x1.5	22.0	23.0	41	35	15	3	EX1540.32.230	25
M32x1.5	23.0	25.5	41	35	15	-	EX1540.32.255	25
M40x1.5	25.5	27.0	50	40	15	3	EX1540.40.270	10
M40x1.5	27.0	28.5	50	40	15	-	EX1540.40.285	10
M40x1.5	28.5	30.0	50	40	15	3	EX1540.40.300	10
M40x1.5	30.0	33.0	50	40	15	-	EX1540.40.330	10
M50x1.5	33.0	35.0	60	42	16	3	EX1540.50.350	10
M50x1.5	35.0	37.0	60	42	16	-	EX1540.50.370	10
M50x1.5	37.0	39.0	60	42	16	3	EX1540.50.390	10
M50x1.5	39.0	42.0	60	42	16	-	EX1540.50.420	10
M63x1.5	42.0	44.0	75	48	16	3	EX1540.63.440	5
M63x1.5	44.0	46.0	75	48	16	-	EX1540.63.460	5
M63x1.5	46.0	48.0	75	48	16	3	EX1540.63.480	5
M63x1.5	48.0	52.0	75	48	16	-	EX1540.63.520	5

3 = Material Dichteinsatz NBR

3 = Material sealing insert NBR



# AGRO Kabelverschraubungen Progress® Kunststoff GFK erhöhte Sicherheit Ex e II

## AGRO synthetic cable glands Progress® GFK increased safety Ex e II

### Anschlussgewinde Pg | Entry thread Pg

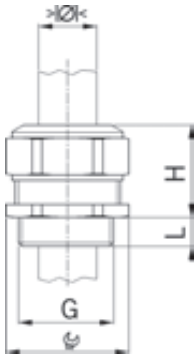

Material: Polyamid  
glasfaserverstärkt

Eigenschaften: halogenfrei

Dichtung: TPE / NBR

Einsatztemperatur: -20°C / +85°C

Schutzart: IP 68

Prüfnorm: IEC EN 60079-0 /  
IEC EN 60079-7

Kategorie 2G: Ex e II

Kategorie 2D: Ex tD A21 IP68

Zone: Gas 1 und 2 / Staub 21  
und 22

Zertifikat: EG-Baumuster-  
prüfbescheinigung  
PTB 02 ATEX 1126X

IECEx Zertifikat: IECEx SEV 12.0002X

Material: Polyamide glass fiber  
reinforced

Properties: Halogen-free

Seal: TPE / NBR

Temperature range: -20°C / +85°C

Protection class: IP 68

Test standard: IEC EN 60079-0 /  
IEC EN 60079-7

Category 2G: Ex e II

Category 2D: Ex tD A21 IP68

Zone: Gas 1 and 2 / dust 21  
and 22

Certificate: EC-type exami-  
nation certificate  
PTB 02 ATEX 1126X

IECEx Certificate: IECEx SEV 12.0002X

### Progress GFK EX



Hellgrau RAL 7035  
Einteiliger Dichteinsatz

Light grey RAL 7035  
One-piece sealing insert

G	>Ø< min mm	>Ø< max mm		H mm	L mm	i info	Art.-Nr.   Art. No.	
Pg 9	4.5	6.0	21	26	12	-	EX1571.09.060	50
Pg 9	6.0	8.0	21	26	12	-	EX1571.09.080	50
Pg 11	4.0	5.5	24	28	12	-	EX1571.11.055	50
Pg 11	5.5	8.5	24	28	12	-	EX1571.11.085	50
Pg 13	6.0	8.0	27	28	13	-	EX1571.13.080	50
Pg 13	8.0	11.0	27	28	13	-	EX1571.13.110	50
Pg 16	6.0	8.0	27	28	13	-	EX1571.16.080	50
Pg 16	8.0	11.0	27	28	13	-	EX1571.16.110	50
Pg 21	9.5	12.5	34	33	13	-	EX1571.21.125	25
Pg 21	12.5	16.0	34	33	13	-	EX1571.21.160	25
Pg 21	16.0	19.0	34	33	13	-	EX1571.21.190	25
Pg 21	19.0	20.5	34	33	13	-	EX1571.21.205	25
Pg 29	19.5	21.0	41	36	13	3	EX1571.29.210	25
Pg 29	21.0	23.0	41	36	13	-	EX1571.29.230	25
Pg 29	23.0	25.0	41	36	13	3	EX1571.29.250	25
Pg 29	25.0	27.5	41	36	13	-	EX1571.29.275	25
Pg 36	27.0	28.5	55	42	16	3	EX1571.36.285	10
Pg 36	28.5	30.5	55	42	16	-	EX1571.36.305	10
Pg 36	30.5	32.5	55	42	16	3	EX1571.36.325	10
Pg 36	32.5	35.0	55	42	16	-	EX1571.36.350	10
Pg 42	33.0	35.0	60	42	16	3	EX1571.42.350	10
Pg 42	35.0	37.0	60	42	16	-	EX1571.42.370	10
Pg 42	37.0	39.0	60	42	16	3	EX1571.42.390	10
Pg 42	39.0	42.0	60	42	16	-	EX1571.42.420	10
Pg 48	41.0	43.0	70	46	16	-	EX1571.48.430	5
Pg 48	43.0	45.0	70	46	16	3	EX1571.48.450	5
Pg 48	45.0	47.0	70	46	16	3	EX1571.48.470	25
Pg 48	47.0	49.0	70	46	16	-	EX1571.48.490	5

3 = Material Dichteinsatz NBR

3 = Material sealing insert NBR

# AGRO Kabelverschraubungen Progress® Kunststoff GFK erhöhte Sicherheit Ex e II

## AGRO synthetic cable glands Progress® GFK increased safety Ex e II

Anschlussgewinde Pg | Entry thread Pg

Material: Polyamid  
glasfaserverstärkt

Eigenschaften: halogenfrei

Dichtung: TPE / NBR

Einsatztemperatur: -20°C / +85°C

Schutzart: IP 68

Prüfnorm: IEC EN 60079-0 /  
IEC EN 60079-7

Kategorie 2G: Ex e II

Kategorie 2D: Ex tD A21 IP68

Zone: Gas 1 und 2 / Staub 21  
und 22

Zertifikat: EG-Baumuster-  
prüfbescheinigung  
PTB 02 ATEX 1126X

IECEX Zertifikat: IECEX SEV 12.0002X

Material: Polyamide glass fiber  
reinforced

Properties: Halogen-free

Seal: TPE / NBR

Temperature range: -20°C / +85°C

Protection class: IP 68

Test standard: IEC EN 60079-0 /  
IEC EN 60079-7

Category 2G: Ex e II

Category 2D: Ex tD A21 IP68

Zone: Gas 1 and 2 / dust 21  
and 22

Certificate: EC-type exami-  
nation certificate  
PTB 02 ATEX 1126X

IECEX Certificate: IECEX SEV 12.0002X

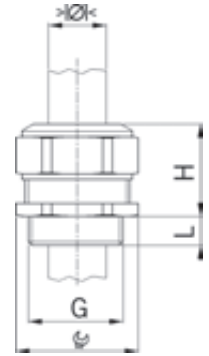

### Progress GFK EX



Schwarz RAL 9005  
Einteiliger Dichteinsatz

Black RAL 9005  
One-piece sealing insert

G	> Ø < min mm	> Ø < max mm		H mm	L mm	i info	Art.-Nr.   Art. No.	
Pg 9	4.5	6.0	21	26	12	-	EX1540.09.060	50
Pg 9	6.0	8.0	21	26	12	-	EX1540.09.080	50
Pg 11	4.0	5.5	24	28	12	-	EX1540.11.055	50
Pg 11	5.5	8.5	24	28	12	-	EX1540.11.085	50
Pg 13	6.0	8.0	27	28	13	-	EX1540.13.080	50
Pg 13	8.0	11.0	27	28	13	-	EX1540.13.110	50
Pg 16	6.0	8.0	27	28	13	-	EX1540.16.080	50
Pg 16	8.0	11.0	27	28	13	-	EX1540.16.110	50
Pg 21	9.5	12.5	34	33	13	-	EX1540.21.125	25
Pg 21	12.5	16.0	34	33	13	-	EX1540.21.160	25
Pg 21	16.0	19.0	34	33	13	-	EX1540.21.190	25
Pg 21	19.0	20.5	34	33	13	-	EX1540.21.205	25
Pg 29	19.5	21.0	41	36	13	3	EX1540.29.210	25
Pg 29	21.0	23.0	41	36	13	-	EX1540.29.230	25
Pg 29	23.0	25.0	41	36	13	3	EX1540.29.250	25
Pg 29	25.0	27.5	41	36	13	-	EX1540.29.275	25
Pg 36	27.0	28.5	55	42	16	3	EX1540.36.285	10
Pg 36	28.5	30.5	55	42	16	-	EX1540.36.305	10
Pg 36	30.5	32.5	55	42	16	3	EX1540.36.325	10
Pg 36	32.5	35.0	55	42	16	-	EX1540.36.350	10
Pg 42	33.0	35.0	60	42	16	3	EX1540.42.350	10
Pg 42	35.0	37.0	60	42	16	-	EX1540.42.370	10
Pg 42	37.0	39.0	60	42	16	3	EX1540.42.390	10
Pg 42	39.0	42.0	60	42	16	-	EX1540.42.420	10
Pg 48	41.0	43.0	70	46	16	-	EX1540.48.430	5
Pg 48	43.0	45.0	70	46	16	3	EX1540.48.450	5
Pg 48	45.0	47.0	70	46	16	3	EX1540.48.470	5
Pg 48	47.0	49.0	70	46	16	-	EX1540.48.490	5

3 = Material Dichteinsatz NBR

3 = Material sealing insert NBR









Anschlussgewinde metrisch | Entry thread metric

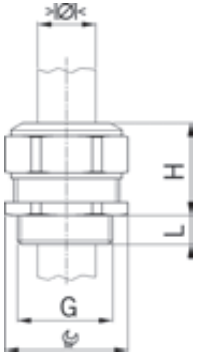

Material: Polyamid  
glasfaserverstärkt  
Eigenschaften: halogenfrei  
Dichtung: TPE / NBR  
Einsatztemperatur: -20°C / +85°C  
Schutzart: IP 68  
Prüfnorm: IEC EN 60079-0 /  
IEC EN 60079-7  
Kategorie 2G: Ex e II / i II  
Kategorie 2D: Ex tD A21 IP68  
Zone: Gas 0, 1 und 2 / Staub  
20, 21 und 22  
Zertifikat: EG-Baumuster-  
prüfbescheinigung  
PTB 02 ATEX 1126X  
IECEx Zertifikat: IECEx SEV 12.0002X

Material: Polyamide glass fiber  
reinforced  
Properties: Halogen-free  
Seal: TPE / NBR  
Temperature range: -20°C / +85°C  
Protection class: IP 68  
Test standard: IEC EN 60079-0 /  
IEC EN 60079-7  
Category 2G: Ex e II / i II  
Category 2D: Ex tD A21 IP68  
Zone: Gas 0, 1 and 2 / dust 20,  
21 and 22  
Certificate: EC-type exami-  
nation certificate  
PTB 02 ATEX 1126X  
IECEx Certificate: IECEx SEV 12.0002X

Progress GFK EX



Lichtblau RAL 5012  
Einteiliger Dichteinsatz

Light blue RAL 5012  
One-piece sealing insert

G	>Ø< min mm	>Ø< max mm		H mm	L mm	i info	Art.-Nr.   Art. No.	
M16x1.5	4.5	6.0	21	26	12	-	EX1530.17.060	50
M16x1.5	6.0	8.0	21	26	12	-	EX1530.17.080	50
M20x1.5	6.0	8.0	27	28	13	-	EX1530.20.080	50
M20x1.5	8.0	11.0	27	28	13	-	EX1530.20.110	50
M25x1.5	9.5	12.5	34	33	13	-	EX1530.25.125	25
M25x1.5	12.5	16.0	34	33	13	-	EX1530.25.160	25
M25x1.5	16.0	19.0	34	33	13	-	EX1530.25.190	25
M25x1.5	19.0	20.5	34	33	13	-	EX1530.25.205	25
M32x1.5	20.0	21.0	41	35	15	-	EX1530.32.210	25
M32x1.5	21.0	22.0	41	35	15	3	EX1530.32.220	25
M32x1.5	22.0	23.0	41	35	15	3	EX1530.32.230	25
M32x1.5	23.0	25.5	41	35	15	-	EX1530.32.255	25
M40x1.5	25.5	27.0	50	40	15	3	EX1530.40.270	10
M40x1.5	27.0	28.5	50	40	15	-	EX1530.40.285	10
M40x1.5	28.5	30.0	50	40	15	3	EX1530.40.300	10
M40x1.5	30.0	33.0	50	40	15	-	EX1530.40.330	10
M50x1.5	33.0	35.0	60	42	16	3	EX1530.50.350	10
M50x1.5	35.0	37.0	60	42	16	-	EX1530.50.370	10
M50x1.5	37.0	39.0	60	42	16	3	EX1530.50.390	10
M50x1.5	39.0	42.0	60	42	16	-	EX1530.50.420	10
M63x1.5	42.0	44.0	75	48	16	3	EX1530.63.440	5
M63x1.5	44.0	46.0	75	48	16	-	EX1530.63.460	5
M63x1.5	46.0	48.0	75	48	16	3	EX1530.63.480	5
M63x1.5	48.0	52.0	75	48	16	-	EX1530.63.520	5

3 = Material Dichteinsatz NBR

3 = Material sealing insert NBR

**Auf Anfrage lieferbar:**

**Available on request:**

Für mehrere Kabel

For installation of multiple cables

Anschlussgewinde Pg | Entry thread Pg

Material: Polyamid  
glasfaserverstärkt  
Eigenschaften: halogenfrei  
Dichtung: TPE / NBR  
Einsatztemperatur: -20°C / +85°C  
Schutzart: IP 68  
Prüfnorm: IEC EN 60079-0 /  
IEC EN 60079-7  
Kategorie 2G: Ex e II / i II  
Kategorie 2D: Ex tD A21 IP68  
Zone: Gas 0, 1 und 2 / Staub  
20, 21 und 22  
Zertifikat: EG-Baumuster-  
prüfbescheinigung  
PTB 02 ATEX 1126X  
IECEx Zertifikat: IECEx SEV 12.0002X

Material: Polyamide glass fiber  
reinforced  
Properties: Halogen-free  
Seal: TPE / NBR  
Temperature range: -20°C / +85°C  
Protection class: IP 68  
Test standard: IEC EN 60079-0 /  
IEC EN 60079-7  
Category 2G: Ex e II / i II  
Category 2D: Ex tD A21 IP68  
Zone: Gas 0, 1 and 2 / dust 20,  
21 and 22  
Certificate: EC-type exami-  
nation certificate  
PTB 02 ATEX 1126X  
IECEx Certificate: IECEx SEV 12.0002X

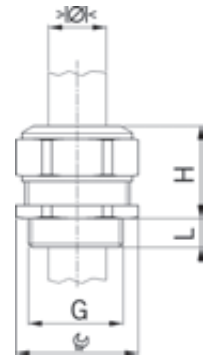

Progress GFK EX



Lichtblau RAL 5012		Light blue RAL 5012						
Einteiliger Dichteinsatz		One-piece sealing insert						
G	> Ø < min mm	> Ø < max mm	info	Art.-Nr.   Art. No.				
Pg 9	4.5	6.0	21	26	12	-	EX1530.09.060	50
Pg 9	6.0	8.0	21	26	12	-	EX1530.09.080	50
Pg 11	4.0	5.5	24	28	12	-	EX1530.11.055	50
Pg 11	5.5	8.5	24	28	12	-	EX1530.11.085	50
Pg 13	6.0	8.0	27	28	13	-	EX1530.13.080	50
Pg 13	8.0	11.0	27	28	13	-	EX1530.13.110	50
Pg 16	6.0	8.0	27	28	13	-	EX1530.16.080	50
Pg 16	8.0	11.0	27	28	13	-	EX1530.16.110	50
Pg 21	9.5	12.5	34	33	13	-	EX1530.21.125	25
Pg 21	12.5	16.0	34	33	13	-	EX1530.21.160	25
Pg 21	16.0	19.0	34	33	13	-	EX1530.21.190	25
Pg 21	19.0	20.5	34	33	13	-	EX1530.21.205	25
Pg 29	19.5	21.0	41	36	13	3	EX1530.29.210	25
Pg 29	21.0	23.0	41	36	13	-	EX1530.29.230	25
Pg 29	23.0	25.0	41	36	13	3	EX1530.29.250	25
Pg 29	25.0	27.5	41	36	13	-	EX1530.29.275	25
Pg 36	27.0	28.5	55	42	16	3	EX1530.36.285	10
Pg 36	28.5	30.5	55	42	16	-	EX1530.36.305	10
Pg 36	30.5	32.5	55	42	16	3	EX1530.36.325	10
Pg 36	32.5	35.0	55	42	16	-	EX1530.36.350	10
Pg 42	33.0	35.0	60	42	16	3	EX1530.42.350	10
Pg 42	35.0	37.0	60	42	16	-	EX1530.42.370	10
Pg 42	37.0	39.0	60	42	16	3	EX1530.42.390	10
Pg 42	39.0	42.0	60	42	16	-	EX1530.42.420	10
Pg 48	41.0	43.0	70	46	16	-	EX1530.48.430	5
Pg 48	43.0	45.0	70	46	16	3	EX1530.48.450	5
Pg 48	45.0	47.0	70	46	16	3	EX1530.48.470	5
Pg 48	47.0	49.0	70	46	16	-	EX1530.48.490	5

3 = Material Dichteinsatz NBR  
3 = Material sealing insert NBR

**Auf Anfrage lieferbar:**  
Für mehrere Kabel

**Available on request:**  
For installation of multiple cables



# Zubehör zu Kabelverschraubungen Messing und Kunststoff erhöhte Sicherheit Ex e II

## Accessories for cable glands brass and synthetic for increased safety Ex e II

### Zubehör | Accessories

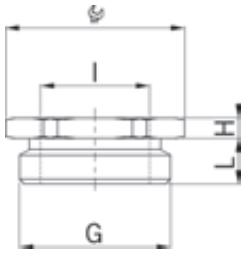

#### Reduktionen Messing erhöhte Sicherheit Ex e II

Material:	Messing vernickelt
O-Ring :	NBR
Einsatztemperatur:	-40°C / +100°C
Schutzart:	IP 68
Prüfnorm:	IEC EN 60079-0 / IEC EN 60079-7
Kategorie 2G:	Ex e II
Kategorie 2D:	Ex tD A21 IP68
Zone:	Gas 1 und 2 / Staub 21 und 22
Zertifikat:	EG-Baumuster- prüfbescheinigung PTB 02 ATEX 1125
IECEx Zertifikat:	IECEx SEV 12.0001

#### Reduction fittings nickel-plated brass increased safety Ex e II

Material:	Nickel-plated brass
O-ring :	NBR
Temperature range:	-40°C / +100°C
Protection class:	IP 68
Test standard:	IEC EN 60079-0 / IEC EN 60079-7
Category 2G:	Ex e II
Category 2D:	Ex tD A21 IP68
Zone:	Gas 1 and 2 / dust 21 and 22
Certificate:	EC-type test certificate PTB 02 ATEX 1125
IECEx Certificate:	IECEx SEV 12.0001



#### Reduktion MS EX



Außengewinde metrisch  
Innengewinde metrisch  
mit O-Ring

Outer thread metric  
Inner thread metric  
with O-ring

G	I	i info	IP 68	H mm	L mm	i info	Art.-Nr.   Art. No.	
M10x1.5	M 8x1.25	1	13	8.0	5	2	EX3500.10.08	50
M12x1.5	M 8x1.25	1	15	3.0	5	2	EX3500.12.08	50
M12x1.5	M10x1.5	1	15	8.0	5	2	EX3500.12.10	50
M16x1.5	M10x1.5	1	18	3.0	5	-	EX3500.17.10	50
M16x1.5	M12x1.5	-	18	3.0	5	-	EX3500.17.12	50
M20x1.5	M12x1.5	-	24	3.0	6	-	EX3500.20.12	50
M20x1.5	M16x1.5	-	24	3.0	6	-	EX3500.20.17	50
M25x1.5	M16x1.5	-	30	3.5	7	-	EX3500.25.17	25
M25x1.5	M20x1.5	-	30	3.5	7	-	EX3500.25.20	25
M32x1.5	M20x1.5	-	36	4.0	8	-	EX3500.32.20	20
M32x1.5	M25x1.5	-	36	4.0	8	-	EX3500.32.25	20
M40x1.5	M25x1.5	-	46	4.5	8	-	EX3500.40.25	10
M40x1.5	M32x1.5	-	46	4.5	8	-	EX3500.40.32	10
M50x1.5	M32x1.5	-	55	5.0	9	-	EX3500.50.32	10
M50x1.5	M40x1.5	-	55	5.0	9	-	EX3500.50.40	10
M63x1.5	M40x1.5	-	70	5.5	10	-	EX3500.63.40	5
M63x1.5	M50x1.5	-	70	5.5	10	-	EX3500.63.50	5

1 = Metrisches Regelgewinde

1 = Metric coarse-pitch thread

2 = Zertifikat PTB 02 ATEX 1126X / IECEx SEV 12.0002X

2 = Certificate PTB 02 ATEX 1126X / IECEx SEV 12.0002X

Das Ineinanderschrauben mehrerer Reduktionen/Erweiterungen ist nach Norm nicht zulässig!

The norm interdicts to screw several reduction/enlarging fittings into each other!

#### Auf Anfrage lieferbar:

#### Available on request:

Reduktionen Messing mit FMP-O-Ring für Einsatztemperaturen bis +200°C

Reduction fittings nickel-plated brass with FPM O-ring for high temperature applications up to +200°C

# Zubehör zu Kabelverschraubungen Messing und Kunststoff erhöhte Sicherheit Ex e II

## Accessories for cable glands brass and synthetic for increased safety Ex e II

Zubehör | Accessories

### Reduktionen Messing erhöhte Sicherheit Ex e II

Material:	Messing vernickelt
O-Ring :	NBR
Einsatztemperatur:	-40°C / +100°C
Schutzart:	IP 68
Prüfnorm:	IEC EN 60079-0 / IEC EN 60079-7
Kategorie 2G:	Ex e II
Kategorie 2D:	Ex tD A21 IP68
Zone:	Gas 1 und 2 / Staub 21 und 22
Zertifikat:	EG-Baumuster- prüfbescheinigung PTB 02 ATEX 1125, Größe Pg 7 PTB 02 ATEX 1126X
IECEx Zertifikat:	IECEx SEV 12.0001

### Reduction fittings nickel-plated brass increased safety Ex e II

Material:	Nickel-plated brass
O-ring :	NBR
Temperature range:	-40°C / +100°C
Protection class:	IP 68
Test standard:	IEC EN 60079-0 / IEC EN 60079-7
Category 2G:	Ex e II
Category 2D:	Ex tD A21 IP68
Zone:	Gas 1 and 2 / dust 21 and 22
Certificate:	EC-type exami- nation certificate PTB 02 ATEX 1125, size Pg 7 PTB 02 ATEX 1126X
IECEx Certificate:	IECEx SEV 12.0001

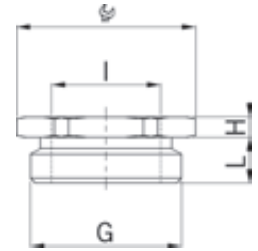

### Reduktion MS EX



Außengewinde Pg		Outer thread Pg						Art.-Nr.   Art. No.	
Innengewinde metrisch mit O-Ring		Inner thread metric with O-ring							
G	I	i info		H mm	L mm	i info			
Pg 7	M 8x1.25	1	15	3.0	6	2	EX3500.07.08	50	
Pg 7	M10x1.5	1	15	7.0	6	2	EX3500.07.10	50	
Pg 9	M 8x1.25	1	18	3.0	6	-	EX3500.09.08	50	
Pg 9	M10x1.5	1	18	3.0	6	-	EX3500.09.10	50	
Pg 9	M12x1.5	-	18	8.0	6	-	EX3500.09.12	50	
Pg 11	M 8x1.25	1	21	3.0	6	-	EX3500.11.08	50	
Pg 11	M10x1.5	1	21	3.0	6	-	EX3500.11.10	50	
Pg 11	M12x1.5	-	21	3.0	6	-	EX3500.11.12	50	
Pg 11	M16x1.5	-	21	8.0	6	-	EX3500.11.17	50	
Pg 13	M12x1.5	-	24	3.0	6	-	EX3500.13.12	50	
Pg 13	M16x1.5	-	24	3.0	6	-	EX3500.13.17	50	
Pg 16	M12x1.5	-	24	3.0	6	-	EX3500.16.12	25	
Pg 16	M16x1.5	-	24	3.0	6	-	EX3500.16.17	25	
Pg 16	M20x1.5	-	24	10.5	6	-	EX3500.16.20	25	
Pg 21	M16x1.5	-	30	3.5	7.5	-	EX3500.21.17	25	
Pg 21	M20x1.5	-	30	3.5	7.5	-	EX3500.21.20	25	
Pg 21	M25x1.5	-	30	10.5	7.5	-	EX3500.21.25	25	
Pg 29	M25x1.5	-	38	4.0	8	-	EX3500.29.25	20	
Pg 29	M32x1.5	-	38	13.0	8	-	EX3500.29.32	20	
Pg 36	M32x1.5	-	50	4.5	8	-	EX3500.36.32	10	
Pg 36	M40x1.5	-	50	4.5	8	-	EX3500.36.40	10	
Pg 42	M32x1.5	-	55	5.0	10	-	EX3500.42.32	10	
Pg 42	M40x1.5	-	55	5.0	10	-	EX3500.42.40	10	
Pg 42	M50x1.5	-	55	15.0	10	-	EX3500.42.50	10	
Pg 48	M40x1.5	-	65	5.5	11	-	EX3500.48.40	5	
Pg 48	M50x1.5	-	65	5.5	11	-	EX3500.48.50	5	



1 = Metrisches Regelgewinde

1 = Metric coarse-pitch thread

2 = Zertifikat PTB 02 ATEX 1126X / IECEx SEV 12.0002X

2 = Certificate PTB 02 ATEX 1126X / IECEx SEV 12.0002X

Das Ineinanderschrauben mehrerer Reduktionen/Erweiterungen ist nach Norm nicht zulässig!

The norm interdicts to screw several reduction/enlarging fittings into each other!

#### Auf Anfrage lieferbar:

#### Available on request:

Reduktionen Messing mit FMP-O-Ring für Einsatztemperaturen bis +200°C

Reduction fittings nickel-plated brass with FPM O-ring for high temperature applications up to +200°C

# Zubehör zu Kabelverschraubungen Messing und Kunststoff erhöhte Sicherheit Ex e II

## Accessories for cable glands brass and synthetic for increased safety Ex e II

### Zubehör | Accessories

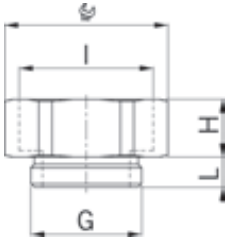

#### Erweiterungen Messing erhöhte Sicherheit Ex e II

Material:	Messing vernickelt
O-Ring :	NBR
Einsatztemperatur:	-40°C / +100°C
Schutzart:	IP 68
Prüfnorm:	IEC EN 60079-0 / IEC EN 60079-7
Kategorie 2G:	Ex e II
Kategorie 2D:	Ex tD A21 IP68
Zone:	Gas 1 und 2 / Staub 21 und 22
Zertifikat:	EG-Baumuster- prüfbescheinigung PTB 02 ATEX 1125
IECEx Zertifikat:	IECEx SEV 12.0001

#### Enlarging fittings nickel-plated brass increased safety Ex e II

Material:	Nickel-plated brass
O-ring :	NBR
Temperature range:	-40°C / +100°C
Protection class:	IP 68
Test standard:	IEC EN 60079-0 / IEC EN 60079-7
Category 2G:	Ex e II
Category 2D:	Ex tD A21 IP68
Zone:	Gas 1 and 2 / dust 21 and 22
Certificate:	EC-type test certificate PTB 02 ATEX 1125
IECEx Certificate:	IECEx SEV 12.0001



#### Erweiterung MS EX



Außengewinde metrisch  
Innengewinde metrisch  
mit O-Ring

Outer thread metric  
Inner thread metric  
with O-ring

G	I	i info	IECEx	H mm	L mm	i info	Art.-Nr.   Art. No.	
<b>M 8x1.25</b>	M10x1.5	1	13	9	5	2	<b>EX3600.08.10</b>	50
<b>M10x1.5</b>	M12x1.5	1	15	9	5	2	<b>EX3600.10.12</b>	50
<b>M12x1.5</b>	M16x1.5	-	18	9	5	2	<b>EX3600.12.17</b>	50
<b>M16x1.5</b>	M20x1.5	-	24	10	5	-	<b>EX3600.17.20</b>	50
<b>M20x1.5</b>	M25x1.5	-	30	11.5	6	-	<b>EX3600.20.25</b>	25
<b>M25x1.5</b>	M32x1.5	-	36	14	7	-	<b>EX3600.25.32</b>	25
<b>M32x1.5</b>	M40x1.5	-	46	14	8	-	<b>EX3600.32.40</b>	25
<b>M40x1.5</b>	M50x1.5	-	55	16	8	-	<b>EX3600.40.50</b>	10
<b>M50x1.5</b>	M63x1.5	-	70	17	9	-	<b>EX3600.50.63</b>	10

1 = Metrisches Regelgewinde

1 = Metric coarse-pitch thread

2 = Zertifikat PTB 02 ATEX 1126X / IECEx SEV 12.0002X

2 = Certificate PTB 02 ATEX 1126X / IECEx SEV 12.0002X

Das Ineinanderschrauben mehrerer Reduktionen/Erweiterungen ist nach Norm nicht zulässig!

The norm interdicts to screw several reduction/enlarging fittings into each other!

#### Auf Anfrage lieferbar:

#### Available on request:

Erweiterungen Messing mit FMP-O-Ring für Einsatztemperaturen bis +200°C

Enlarging fittings nickel-plated brass with O-ring in FPM for high temperature applications up to +200°C

### Erweiterungen Messing erhöhte Sicherheit Ex e II

Material:	Messing vernickelt
O-Ring :	NBR
Einsatztemperatur:	-40°C / +100°C
Schutzart:	IP 68
Prüfnorm:	IEC EN 60079-0 / IEC EN 60079-7
Kategorie 2G:	Ex e II
Kategorie 2D:	Ex tD A21 IP68
Zone:	Gas 1 und 2 / Staub 21 und 22
Zertifikat:	EG-Baumuster- prüfbescheinigung PTB 02 ATEX 1125
IECEx Zertifikat:	IECEx SEV 12.0001

### Enlarging fittings nickel-plated brass increased safety Ex e II

Material:	Nickel-plated brass
O-ring :	NBR
Temperature range:	-40°C / +100°C
Protection class:	IP 68
Test standard:	IEC EN 60079-0 / IEC EN 60079-7
Category 2G:	Ex e II
Category 2D:	Ex tD A21 IP68
Zone:	Gas 1 and 2 / dust 21 and 22
Certificate:	EC-type test certificate PTB 02ATEX 1125
IECEx Certificate:	IECEx SEV 12.0001

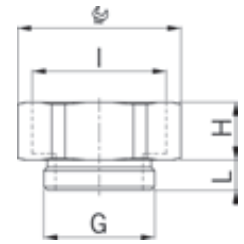

### Erweiterung MS EX



Außengewinde Pg  
Innengewinde metrisch  
mit O-Ring

Outer thread Pg  
Inner thread metric  
with O-ring

G	I		H mm	L mm	i info	Art.-Nr.   Art. No.	
Pg 7	M12x1.5	15	9.0	6	2	EX3600.07.12	50
Pg 7	M16x1.5	18	9.0	6	2	EX3600.07.17	50
Pg 9	M16x1.5	18	9.5	6	-	EX3600.09.17	50
Pg 9	M20x1.5	24	10.5	6	-	EX3600.09.20	50
Pg 11	M20x1.5	24	10.5	6	-	EX3600.11.20	50
Pg 11	M25x1.5	30	11.5	6	-	EX3600.11.25	25
Pg 13	M20x1.5	24	10.5	6	-	EX3600.13.20	50
Pg 13	M25x1.5	30	11.5	6	-	EX3600.13.25	25
Pg 16	M25x1.5	30	11.5	6	-	EX3600.16.25	25
Pg 16	M32x1.5	36	13.5	6	-	EX3600.16.32	25
Pg 21	M32x1.5	36	14.0	7.5	-	EX3600.21.32	25
Pg 21	M40x1.5	46	14.0	7.5	-	EX3600.21.40	20
Pg 29	M40x1.5	46	14.0	8	-	EX3600.29.40	20
Pg 29	M50x1.5	55	16.0	8	-	EX3600.29.50	10
Pg 36	M50x1.5	55	16.0	8	-	EX3600.36.50	10
Pg 36	M63x1.5	70	17.0	8	-	EX3600.36.63	10
Pg 42	M63x1.5	70	17.0	10	-	EX3600.42.63	10
Pg 48	M63x1.5	70	17.0	11	-	EX3600.48.63	10



1 = Metrisches Regelgewinde

1 = Metric coarse-pitch thread

2 = Zertifikat PTB 02 ATEX 1126X / IECEx SEV 12.0002X

2 = Certificate PTB 02 ATEX 1126X / IECEx SEV 12.0002X

Das Ineinanderschrauben mehrerer Reduktionen/Erweiterungen ist nach Norm nicht zulässig!

The norm interdicts to screw several reduction/enlarging fittings into each other!

#### Auf Anfrage lieferbar:

Erweiterungen Messing mit FMP-O-Ring für Einsatztemperaturen bis +200°C

#### Available on request:

Enlarging fittings nickel-plated brass with O-ring in FPM for high temperature applications up to +200°C



### Kurzes Anschlussgewinde metrisch | Short entry thread metric

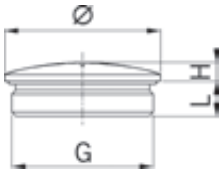

#### Verschlusschrauben Messing erhöhte Sicherheit Ex e II

Material:	Messing vernickelt
O-Ring :	NBR
Einsatztemperatur:	-40°C / +100°C
Schutzart:	IP 68
Prüfnorm:	IEC EN 60079-0 / IEC EN 60079-7
Kategorie 2G:	Ex e II
Kategorie 2D:	Ex tD A21 IP68
Zone:	Gas 1 und 2 / Staub 21 und 22
Zertifikat:	EG-Baumusterprüfbescheinigung PTB 02 ATEX 1125
IECEx Zertifikat:	IECEx SEV 12.0001

#### Locking plugs nickel-plated brass increased safety Ex e II

Material:	Nickel-plated brass
O-ring :	NBR
Temperature range:	-40°C / +100°C
Protection class:	IP 68
Test standard:	IEC EN 60079-0 / IEC EN 60079-7
Category 2G:	Ex e II
Category 2D:	Ex tD A21 IP68
Zone:	Gas 1 and 2 / dust 21 and 22
Certificate:	EC-type test certificate PTB 02 ATEX 1125
IECEx Certificate:	IECEx SEV 12.0001



#### Verschlusszapfen MS EX



mit O-Ring					with O-ring	
G	Ø mm	H mm	L mm	i info	Art.-Nr.   Art. No.	
M8x1.25	10	3	5	1	EX8708.08	50
M10x1.5	12	3	5	1	EX8710.08	50
M12x1.5	14	3	5	-	EX8712.08	50
M16x1.5	19	3	5	-	EX8717.08	50
M20x1.5	24	3	6	-	EX8720.08	25
M25x1.5	28	4	7	-	EX8725.08	25
M32x1.5	35	4	8	-	EX8732.08	10
M40x1.5	45	6	8	-	EX8740.08	10
M50x1.5	55	6	9	-	EX8750.08	10
M63x1.5	70	6	10	-	EX8763.08	10

1 = Metrisches Regelgewinde      1 = Metric coarse-pitch thread

**Auf Anfrage lieferbar:**      **Available on request:**

- Langes Anschlussgewinde      - Long entry thread
- Verschlusschrauben aus rostfreiem Stahl A2 oder rostfreiem und säurebeständigem Stahl A4 mit kurzem oder langem Anschlussgewinde metrisch      - Locking plugs in stainless steel A2 or acid-proof stainless steel A4 with short or long metric entry thread
- Verschlusschrauben mit FPM-O-Ring für Einsatztemperaturen bis +200°C      - Locking plugs with O-ring in FPM for temperatures up to +200°C

### Kurzes Anschlussgewinde Pg | Short entry thread Pg



#### Verschlusszapfen MS EX



mit O-Ring					with O-ring	
G	Ø mm	H mm	L mm		Art.-Nr.   Art. No.	
Pg 7	14	3	5		EX8707.08	50
Pg 9	17	3	6		EX8709.08	50
Pg 11	20	3	6		EX8711.08	50
Pg 13	22	3	6.5		EX8713.08	50
Pg 16	24	3	6.5		EX8716.08	50
Pg 21	30	4	7		EX8721.08	10
Pg 29	39	4	8		EX8729.08	10
Pg 36	50	6	9		EX8736.08	10
Pg 48	65	6	10		EX8748.08	10

**Auf Anfrage lieferbar:**      **Available on request:**

- Langes Anschlussgewinde      - Long entry thread
- Verschlusschrauben aus rostfreiem Stahl A2 oder rostfreiem und säurebeständigem Stahl A4 mit kurzem oder langem Anschlussgewinde metrisch      - Locking plugs in stainless steel A2 or acid-proof stainless steel A4 with short or long metric entry thread
- Verschlusschrauben mit FPM-O-Ring für Einsatztemperaturen bis +200°C      - Locking plugs with O-ring in FPM for temperatures up to +200°C

# Zubehör zu Kabelverschraubungen Messing und Kunststoff erhöhte Sicherheit Ex e II

## Accessories for cable glands brass and synthetic for increased safety Ex e II

### Anschlussgewinde metrisch | Entry thread metric

#### Verschlusschrauben Kunststoff erhöhte Sicherheit Ex e II

#### Synthetic locking plugs for increased safety Ex e II

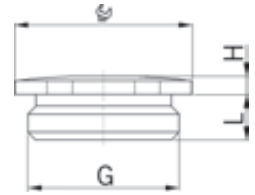

Material:	Polyamid
O-Ring :	NBR
Einsatztemperatur:	-20°C / +90°C
Schutzart:	IP 68
Prüfnorm:	IEC EN 60079-0 / IEC EN 60079-7
Kategorie 2G:	Ex e II
Kategorie 2D:	Ex tD A21 IP68
Zone:	Gas 1 und 2 / Staub 21 und 22
Zertifikat:	EG-Baumusterprüfbescheinigung DMT 03 ATEX E 049
IECEx Zertifikat:	IECEx BVS 07.0021

Material:	Polyamide
O-ring :	NBR
Temperature range:	-20°C / +90°C
Protection class:	IP 68
Test standard:	IEC EN 60079-0 / IEC EN 60079-7
Category 2G:	Ex e II
Category 2D:	Ex tD A21 IP68
Zone:	Gas 1 and 2 / dust 21 and 22
Certificate:	EC-type test certificate DMT 03 ATEX E 049
IECEx Certificate:	IECEx BVS 07.0021



Schwarz RAL 9005 mit O-Ring

Black RAL 9005 with O-ring

G			H mm	L mm	Art.-Nr.   Art. No.	
M12x1.5	15	6	13.0	8.5	8841.12	100
M16x1.5	19	8	13.0	8.5	8841.17	100
M20x1.5	24	8	14.5	9.0	8841.20	100
M25x1.5	28	8	16.0	10.5	8841.25	100
M32x1.5	36	8	17.5	11.5	8841.32	100
M40x1.5	46	8	18.0	11.5	8841.40	50
M50x1.5	55	8	20.0	13.5	8841.50	25
M63x1.5	70	8	21.0	14.5	8841.63	10



### Anschlussgewinde Pg | Entry thread Pg



Schwarz RAL 9005 mit O-Ring

Black RAL 9005 with O-ring

G			H mm	L mm	Art.-Nr.   Art. No.	
Pg 7	15	6	13.0	8.5	8841.07	100
Pg 9	19	8	13.0	8.5	8841.09	100
Pg 11	24	8	14.5	9.0	8841.11	100
Pg 13	24	8	14.5	9.0	8841.13	100
Pg 16	28	8	16.0	10.5	8841.16	100
Pg 21	36	8	17.5	11.5	8841.21	100
Pg 29	46	8	18.0	11.5	8841.29	50
Pg 36	55	8	20.0	13.5	8841.36	25
Pg 42	60	8	20.0	13.5	8841.42	10
Pg 48	70	8	21.0	14.5	8841.48	10



# AGRO Kombi-Schlauchverschraubung aus Messing

## AGRO Combination conduit glands nickel-plated brass

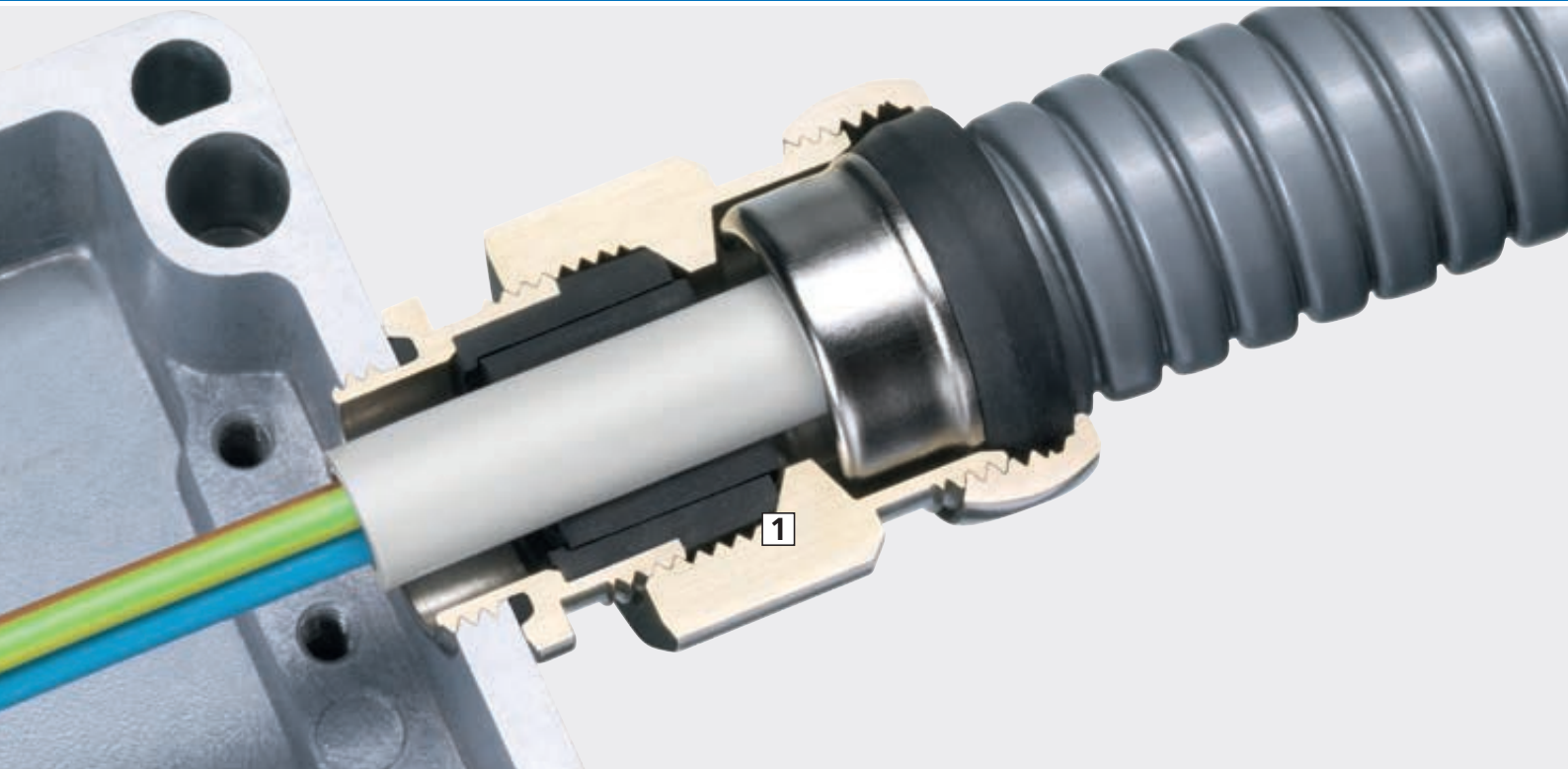

AGRO Kombi-Schlauchverschraubungen sind eine optimale Lösung, wenn Sie Kabel in einem Schutzschlauch in ein Gehäuse einführen wollen und gleichzeitig eine sichere Abdichtung und Zugentlastung des Kabels möchten.

### **1 Dichtheit**

Mit der integrierten Kabelverschraubung erzielen Sie eine hervorragende Dichtheit (IP 68) im Innenbereich des Schutzschlauchs. So verhindern Sie das Eindringen von Flüssigkeiten und Kondenswasser.

### **Integrierte EMV Kabelverschraubung**

Die Kombi-Schlauchverschraubung gibt es auch als kombinierte Variante für geschirmte Kabel.

Kommen Kombi-Schlauchverschraubungen in **Bahnapplikationen** zum Einsatz - etwa weil Kabel in Schutzschläuchen geführt werden, um sie vor Schlägen oder Manipulation zu schützen - so gelten für sie die selben Anforderungen wie für Kabelverschraubungen: sie müssen mit einem Dichteinsatz aus Spezial-TPE gemäß **EN 45545** bestückt werden.

AGRO Combination conduit glands are an optimal solution if you want to feed cables inside a conduit into an enclosure and at the same time want a secure seal and strain relief for the cables.

### **1 Sealing capability**

The integrated cable gland achieves excellent sealing (IP 68) inside the conduit. In this way, you make certain that water and condensate cannot make its way inside.

### **Integrated EMC cable gland**

The combination conduit gland is also available in a special version for shielded cables.

In cases where combination conduit glands are used for **railway applications** - for instance when cables are laid in conduits in order to protect them from impacts or manipulation - the same requirements apply as for cable glands: the combination conduit glands must be equipped with a sealing insert made of special TPE according to the requirements of **EN 45545**.



Kombi-Schlauchverschraubung Progress® Messing mit integrierter Kabelverschraubung Combination conduit glands Progress® nickel-plated brass with integrated cable gland	 <b>152 - 154</b>	1
Adapter Progress® Messing mit integrierter Kabelverschraubung Adapter Progress® nickel-plated brass with integrated cable gland	 <b>155 - 156</b>	2
Kombi-Schlauchverschraubung Progress® EMV Messing mit integrierter Kabelverschraubung Combination conduit glands Progress® EMC nickel-plated brass with integrated cable gland	 <b>157 - 159</b>	3
Adapter Progress® Messing mit integrierter EMV-Kabelverschraubung Adapters Progress® nickel-plated brass with integrated EMC cable gland	 <b>160 - 161</b>	4
Kombi-EMV-Schlauchverschraubung für Kupfer-Hohlgeflechte Combination EMC conduit gland for copper braidings	 <b>162</b>	5
Zubehör zu Schlauchverschraubungen Conduit glands accessories	 <b>163</b>	6

**Kurzes Anschlussgewinde metrisch | Short entry thread metric**

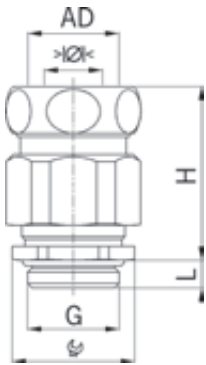

Material: Messing vernickelt  
 Dichtung: TPE  
 O-Ring : NBR  
 Zugentlastung: Ausführung A  
 Einsatztemperatur: -40°C / +100°C  
 Schutzart: Kabelverschraubung IP 68  
 Hinweis: Die Schutzart des Schlauchanschlusses ist abhängig von der Wahl des Schlauchtyps

Material: Nickel-plated brass  
 Seal: TPE  
 O-ring : NBR  
 Strain relief: Version A  
 Temperature range: -40°C / +100°C  
 Protection class: Cable gland IP 68  
 Note: The protection class of the conduit fitting depends on the selection of the type of conduit



**Progress MS Kombi**



Für Schlauchanschluss AD mm  
 Zweiteiliger Dichteinsatz  
 nicht durchgehend isolierend

Connector for tubing with AD mm  
 Two-piece sealing insert  
 not overall length insulated

G	AD mm	>Ø< min mm	>Ø< max mm		H mm	L mm	Art.-Nr.   Art. No.	
M12x1.5	10	5.0	6.5	15/17	33	5	1700.12.10	50
M16x1.5	14	6.0	10.5	18/21	38	5	1700.17.14	50
M20x1.5	17	8.0	15.0	24/25	38	6	1700.20.17	25
M20x1.5	19	8.0	15.0	24/27	39	6	1700.20.19	25
M20x1.5	21	8.0	15.0	24/29	39	6	1700.20.21	25
M25x1.5	21	12.5	20.5	30/29	43	7	1700.25.21	25
M25x1.5	27	12.5	20.5	30/36	50	7	1700.25.27	25
M32x1.5	27	17.0	25.5	36/36	52	8	1700.32.27	25
M40x1.5	36	24.0	33.0	46/45	56	8	1700.40.36	10
M50x1.5	45	33.0	42.0	55/54	60	9	1700.50.45	10
M63x1.5	56	40.0	52.0	70/66	67	10	1700.63.56	5

Je nach Schlauchtyp muss die passende Stabilisierungshülse separat bestellt werden.

Depending on the type of conduit, the stabilising bush must be ordered separately.

Erhältlich mit Dichteinsatz gemäß EN 45545. Bei Anfragen oder Bestellung bitte ein F vor die Artikelnummer setzen.

Available with sealing inserts conformity with EN 45545. When placing an inquiry, prefix the article number by the capital F.

**Progress MS Kombi**



Für Schlauchanschluss AD Zoll  
 Zweiteiliger Dichteinsatz  
 nicht durchgehend isolierend

Connector for tubing with AD in inches  
 Two-piece sealing insert  
 not overall length insulated

G	AD mm	>Ø< min mm	>Ø< max mm		H mm	L mm	Art.-Nr.   Art. No.	
M12x1.5	1/4"	5.0	6.5	15/19	35	5	1700.12.1/4	50
M20x1.5	3/8"	8.0	15.0	24/27	42	6	1700.20.3/8	25
M20x1.5	1/2"	8.0	15.0	24/29	38	6	1700.20.1/2	25
M25x1.5	3/4"	12.5	20.5	30/36	52	7	1700.25.3/4	25
M32x1.5	1"	17.0	25.5	36/45	55	8	1700.32.1	25
M40x1.5	1 1/4"	24.0	33.0	46/54	62	8	1700.40.11/4	10
M63x1.5	2"	40.0	52.0	70/70	74	10	1700.63.2	5

Je nach Schlauchtyp muss die passende Stabilisierungshülse separat bestellt werden.

Depending on the type of conduit, the stabilising bush must be ordered separately.

Erhältlich mit Dichteinsatz gemäß EN 45545. Bei Anfragen oder Bestellung bitte ein F vor die Artikelnummer setzen.

Available with sealing inserts conformity with EN 45545. When placing an inquiry, prefix the article number by the capital F.

# AGRO Kombi-Schlauchverschraubung Progress® Messing mit integrierter Kabelverschraubung

## AGRO combination conduit glands Progress® nickel-plated brass with integrated cable gland

Langes Anschlussgewinde metrisch | Long entry thread metric

Material: Messing vernickelt  
 Dichtung: TPE  
 O-Ring : NBR  
 Zugentlastung: Ausführung A  
 Einsatztemperatur: -40°C / +100°C  
 Schutzart: Kabelverschraubung IP 68  
 Hinweis: Die Schutzart des Schlauchanschlusses ist abhängig von der Wahl des Schlauchtyps

Material: Nickel-plated brass  
 Seal: TPE  
 O-ring : NBR  
 Strain relief: Version A  
 Temperature range: -40°C / +100°C  
 Protection class: Cable gland IP 68  
 Note: The protection class of the conduit fitting depends on the selection of the type of conduit

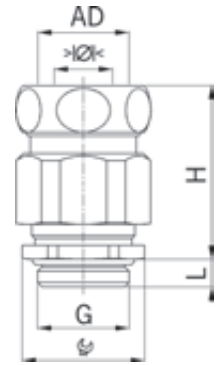

### Progress MS Kombi



Für Schlauchanschluss AD mm  
 Zweiteiliger Dichteinsatz  
 durchgehend isolierend

Connector for tubing with AD mm  
 Two-piece sealing insert  
 overall length insulated

G	AD mm	>Ø< min mm	>Ø< max mm		H mm	L mm	Art.-Nr.   Art. No.	
M12x1.5	10	5.0	6.5	15/17	33	10	1710.60.12.10	50
M16x1.5	14	6.0	10.5	18/21	38	10	1710.60.17.14	50
M20x1.5	17	8.0	14.5	24/25	38	10	1710.60.20.17	25
M20x1.5	19	8.0	14.5	24/27	39	10	1710.60.20.19	25
M20x1.5	21	8.0	14.5	24/29	39	10	1710.60.20.21	25
M25x1.5	21	12.5	19.0	30/29	43	11	1710.60.25.21	25
M25x1.5	27	12.5	19.0	30/36	50	11	1710.60.25.27	25
M32x1.5	27	17.0	25.5	36/36	52	13	1710.60.32.27	25
M40x1.5	36	24.0	33.0	46/45	56	13	1710.60.40.36	10
M50x1.5	45	33.0	42.0	55/54	60	14	1710.60.50.45	10
M63x1.5	56	40.0	52.0	70/66	67	14	1710.60.63.56	5



Je nach Schlauchttyp muss die passende Stabilisierungshülse separat bestellt werden.

Depending on the type of conduit, the stabilising bush must be ordered separately.

Erhältlich mit Dichteinsatz gemäß EN 45545. Bei Anfragen oder Bestellung bitte ein F vor die Artikelnummer setzen.

Available with sealing inserts conformity with EN 45545. When placing an inquiry, prefix the article number by the capital F.

### Progress MS Kombi



Für Schlauchanschluss AD Zoll  
 Zweiteiliger Dichteinsatz  
 durchgehend isolierend

Connector for tubing with AD in inches  
 Two-piece sealing insert  
 overall length insulated

G	AD mm	>Ø< min mm	>Ø< max mm		H mm	L mm	Art.-Nr.   Art. No.	
M12x1.5	1/4"	5.0	6.5	15/19	35	10	1710.60.12.1/4	50
M20x1.5	3/8"	8.0	14.5	24/27	42	10	1710.60.20.3/8	25
M20x1.5	1/2"	8.0	14.5	24/29	38	10	1710.60.20.1/2	25
M25x1.5	3/4"	12.5	19.0	30/36	52	11	1710.60.25.3/4	25
M32x1.5	1"	17.0	19.0	36/45	55	13	1710.60.32.1	25
M40x1.5	1 1/4"	24.0	33.0	46/54	62	13	1710.60.40.11/4	10
M63x1.5	2"	40.0	52.0	70/70	74	14	1710.60.63.2	5



Je nach Schlauchttyp muss die passende Stabilisierungshülse separat bestellt werden.

Depending on the type of conduit, the stabilising bush must be ordered separately.

Erhältlich mit Dichteinsatz gemäß EN 45545. Bei Anfragen oder Bestellung bitte ein F vor die Artikelnummer setzen.

Available with sealing inserts conformity with EN 45545. When placing an inquiry, prefix the article number by the capital F.



# AGRO Kombi-Schlauchverschraubung Progress® Messing mit integrierter Kabelverschraubung

## AGRO combination conduit glands Progress® nickel-plated brass with integrated cable gland

### Kurzes Anschlussgewinde Pg | Short entry thread Pg

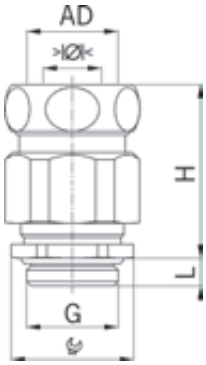

Material: Messing vernickelt  
 Dichtung: TPE  
 O-Ring : NBR  
 Einsatztemperatur: -40°C / +100°C  
 Schutzart: Kabelverschraubung IP 68  
 Hinweis: Die Schutzart des Schlauchanschlusses ist abhängig von der Wahl des Schlauchtyps

Material: Nickel-plated brass  
 Seal: TPE  
 O-ring : NBR  
 Temperature range: -40°C / +100°C  
 Protection class: Cable gland IP 68



Note: The protection class of the conduit fitting depends on the selection of the type of conduit



#### Progress MS Kombi

Für Schlauchanschluss AD mm  
 Zweiteiliger Dichteinsatz  
 nicht durchgehend isolierend

Connector for tubing with AD mm  
 Two-piece sealing insert  
 not overall length insulated

G	AD mm	>Ø< min mm	>Ø< max mm		H mm	L mm	Art.-Nr.   Art. No.	
Pg 7	10	5.0	6.5	15/17	33	6	1700.07.10	50
Pg 9	14	6.0	10.5	18/21	38	6	1700.09.14	50
Pg 11	14	5.5	12.0	21/21	39	6	1700.11.14	50
Pg 11	17	5.5	12.0	21/25	39	6	1700.11.17	50
Pg 13	19	8.0	15.0	24/27	39	6	1700.13.19	25
Pg 16	17	8.0	15.0	24/25	38	6	1700.16.17	25
Pg 16	21	8.0	15.0	24/29	39	6	1700.16.21	25
Pg 21	27	12.5	20.5	30/36	50	7.5	1700.21.27	25
Pg 29	36	19.0	27.5	38/45	55	8	1700.29.36	25
Pg 36	45	26.0	35.0	50/54	60	8	1700.36.45	10
Pg 42	45	33.0	42.0	55/54	60	10	1700.42.45	10
Pg 48	56	37.0	49.0	65/66	67	11	1700.48.56	10

Je nach Schlauchtyp muss die passende Stabilisierungshülse separat bestellt werden.

Depending on the type of conduit, the stabilising bush must be ordered separately.

Erhältlich mit Dichteinsatz gemäß EN 45545. Bei Anfragen oder Bestellung bitte ein F vor die Artikelnummer setzen.

Available with sealing inserts conformity with EN 45545. When placing an inquiry, prefix the article number by the capital F.



### Langes Anschlussgewinde Pg | Long entry thread Pg



#### Progress MS Kombi

Für Schlauchanschluss AD mm  
 Zweiteiliger Dichteinsatz  
 durchgehend isolierend

Connector for tubing with AD mm  
 Two-piece sealing insert  
 overall length insulated

G	AD mm	>Ø< min mm	>Ø< max mm		H mm	L mm	Art.-Nr.   Art. No.	
Pg 7	10	5.0	6.5	15/17	33	10	1710.60.07.10	50
Pg 9	14	6.0	10.5	18/21	38	10	1710.60.09.14	50
Pg 11	14	5.5	12.0	21/21	39	10	1710.60.11.14	50
Pg 11	17	5.5	12.0	21/25	39	10	1710.60.11.17	50
Pg 13	19	8.0	14.5	24/27	39	10	1710.60.13.19	25
Pg 16	17	8.0	14.5	24/25	38	10	1710.60.16.17	25
Pg 16	21	8.0	14.5	24/29	39	10	1710.60.16.21	25
Pg 21	27	12.5	19.0	30/36	50	12	1710.60.21.27	25
Pg 29	36	19.0	27.5	38/45	55	12	1710.60.29.36	25
Pg 36	45	26.0	35.0	50/54	60	15	1710.60.36.45	10
Pg 42	45	33.0	42.0	55/54	60	15	1710.60.42.45	10
Pg 48	56	37.0	49.0	65/66	67	15	1710.60.48.56	10

Je nach Schlauchtyp muss die passende Stabilisierungshülse separat bestellt werden.

Depending on the type of conduit, the stabilising bush must be ordered separately.

Erhältlich mit Dichteinsatz gemäß EN 45545. Bei Anfragen oder Bestellung bitte ein F vor die Artikelnummer setzen.

Available with sealing inserts conformity with EN 45545. When placing an inquiry, prefix the article number by the capital F.

# AGRO Adapter Progress® Messing mit integrierter Kabelverschraubung

## AGRO Adapter Progress® nickel-plated brass with integrated cable gland

Langes Anschlussgewinde metrisch | Long entry thread metric

Material: Messing vernickelt  
 Dichtung: TPE  
 O-Ring : NBR  
 Zugentlastung: Ausführung A  
 Einsatztemperatur: -40°C / +100°C  
 Schutzart: Kabelverschraubung IP 68  
 Hinweis: Die Schutzart ist abhängig von der Wahl des Schlauchtyps

Material: Nickel-plated brass  
 Seal: TPE  
 O-ring : NBR  
 Strain relief: Version A  
 Temperature range: -40°C / +100°C  
 Protection class: Cable gland IP 68  
 Note: The protection class depends on the selection of the connector

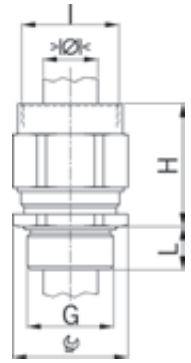

### Progress MS Adapter



Einteiliger Dichteinsatz durchgehend isolierend

One-piece sealing insert overall length insulated

G	I	> Ø < min mm	> Ø < max mm	mm	H mm	L mm	i info	Art.-Nr.   Art. No.	
M10x1.5	M10x1.5	4.0	6.0	13	30	10	1	1165.10	50
M12x1.5	M12x1.5	5.0	6.5	15	32	10	-	1165.12	50

1 = Metrisches Regelgewinde

1 = Metric coarse-pitch thread

Erhältlich mit Dichteinsatz gemäß EN 45545. Bei Anfragen oder Bestellung bitte ein F vor die Artikelnummer setzen.

Available with sealing inserts conformity with EN 45545. When placing an inquiry, prefix the article number by the capital F.



### Progress MS Adapter



Zweiteiliger Dichteinsatz durchgehend isolierend

Two-piece sealing insert overall length insulated

G	I	> Ø < min mm	> Ø < max mm	mm	H mm	L mm	Art.-Nr.   Art. No.	
M16x1.5	M16x1.5	6.0	10.5	18	35	10	1165.17	50
M20x1.5	M20x1.5	8.0	14.5	24	36	10	1165.20	25
M25x1.5	M25x1.5	12.5	19.0	30	41	11	1165.25	25
M32x1.5	M32x1.5	17.0	25.5	36	46	13	1165.32	25
M40x1.5	M40x1.5	24.0	33.0	46	48	13	1165.40	10
M50x1.5	M50x1.5	33.0	42.0	55	53	14	1165.50	5
M63x1.5	M63x1.5	40.0	52.0	70	56	14	1165.63	5

Erhältlich mit Dichteinsatz gemäß EN 45545. Bei Anfragen oder Bestellung bitte ein F vor die Artikelnummer setzen.

Available with sealing inserts conformity with EN 45545. When placing an inquiry, prefix the article number by the capital F.



# AGRO Adapter Progress® Messing mit integrierter Kabelverschraubung

## AGRO Adapter Progress® nickel-plated brass with integrated cable gland

### Langes Anschlussgewinde Pg | Long entry thread Pg

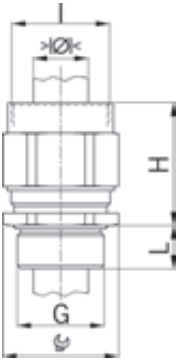

Material: Messing vernickelt  
 Dichtung: TPE  
 O-Ring : NBR  
 Einsatztemperatur: -40°C / +100°C  
 Schutzart: Kabelverschraubung IP 68  
 Hinweis: Die Schutzart ist abhängig von der Wahl des Schlauchtyps

Material: Nickel-plated brass  
 Seal: TPE  
 O-ring : NBR  
 Temperature range: -40°C / +100°C  
 Protection class: Cable gland IP 68  
 Note: The protection class depends on the selection of the connector

#### Progress MS Adapter



Einteiliger Dichteinsatz durchgehend isolierend

One-piece sealing insert overall length insulated

G	I	$\gt\varnothing\lt$ min mm	$\gt\varnothing\lt$ max mm		H mm	L mm	Art.-Nr.   Art. No.	
Pg 7	Pg 7	5.0	6.5	15	30	10	<b>1165.07</b>	50

Erhältlich mit Dichteinsatz gemäß EN 45545. Bei Anfragen oder Bestellung bitte ein F vor die Artikelnummer setzen.

Available with sealing inserts conformity with EN 45545. When placing an inquiry, prefix the article number by the capital F.

#### Progress MS Adapter



Zweiteiliger Dichteinsatz durchgehend isolierend

Two-piece sealing insert overall length insulated

G	I	$\gt\varnothing\lt$ min mm	$\gt\varnothing\lt$ max mm		H mm	L mm	Art.-Nr.   Art. No.	
Pg 9	Pg 9	6.0	10.5	18	35	10	<b>1165.09</b>	50
Pg 11	Pg 11	5.5	12.0	21	36	10	<b>1165.11</b>	50
Pg 13	Pg 13	8.0	14.5	24	36	10	<b>1165.13</b>	25
Pg 16	Pg 16	8.0	14.5	24	37	10	<b>1165.16</b>	25
Pg 21	Pg 21	12.5	19.0	30	42	12	<b>1165.21</b>	25
Pg 29	Pg 29	19.0	27.5	38/40	45	12	<b>1165.29</b>	10
Pg 36	Pg 36	26.0	35.0	50	52	15	<b>1165.36</b>	10
Pg 48	Pg 48	37.0	49.0	65	56	15	<b>1165.48</b>	5

Erhältlich mit Dichteinsatz gemäß EN 45545. Bei Anfragen oder Bestellung bitte ein F vor die Artikelnummer setzen.

Available with sealing inserts conformity with EN 45545. When placing an inquiry, prefix the article number by the capital F.

### Langes Anschlussgewinde metrisch | Long entry thread metric

Material: Messing vernickelt  
 Dichtung: TPE  
 O-Ring : NBR  
 Zugentlastung: Ausführung A  
 Einsatztemperatur: -40°C / +100°C  
 Schutzart: Kabelverschraubung IP 68  
 Hinweis: Die Schutzart des Schlauchanschlusses ist abhängig von der Wahl des Schlauchtyps

Material: Nickel-plated brass  
 Seal: TPE  
 O-ring : NBR  
 Strain relief: Version A  
 Temperature range: -40°C / +100°C  
 Protection class: Cable gland IP 68  
 Note: The protection class of the conduit fitting depends on the selection of the type of conduit

Properties: Excellent shield contact through the contact sleeve with the braided shield terminating in the screwed cable gland

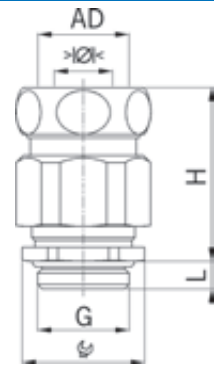

Eigenschaften: Sehr guter Schirmkontakt über die Kontakthülse bei in der Kabelverschraubung endendem Schirmgeflecht

#### Progress MS Kombi EMC



Einteiliger Dichteinsatz nicht durchgehend isolierend		One-piece sealing insert not overall length insulated						Art.-Nr.   Art. No.		
G	AD mm	>Ø< min mm	>Ø< max mm		H mm	L mm				
M12x1.5	10	4.5	6.0	15-17	35	10	1710.80.12.060.1		25	
M16x1.5	14	6.0	8.0	18/21	40	10	1710.80.17.080.1		25	
M16x1.5	14	8.0	10.0	18/21	40	10	1710.80.17.100.1		25	
M20x1.5	17	8.0	11.0	24/25	42	10	1710.80.20.110.1		25	
M20x1.5	17	11.0	14.0	24/25	42	10	1710.80.20.140.1		25	
M20x1.5	19	8.0	11.0	24/27	43	10	1710.80.20.110.2		25	
M20x1.5	19	11.0	14.0	24/27	43	10	1710.80.20.140.2		25	
M25x1.5	21	13.0	16.0	30/29	48	11	1710.80.25.160.1		25	
M25x1.5	27	16.0	19.0	30/36	52	11	1710.80.25.190.1		25	
M32x1.5	27	18.0	21.0	36/36	55	13	1710.80.32.210.1		10	
M32x1.5	27	21.0	25.0	36/36	55	13	1710.80.32.250.1		10	
M40x1.5	36	24.0	28.5	46/45	60	13	1710.80.40.285.1		10	
M40x1.5	36	28.5	32.0	46/45	60	13	1710.80.40.320.1		10	
M50x1.5	45	33.0	37.0	55/54	62	14	1710.80.50.370.1		5	
M50x1.5	45	37.0	41.0	55/54	62	14	1710.80.50.410.1		5	
M63x1.5	56	40.0	46.0	70/66	69	14	1710.80.63.460.1		5	
M63x1.5	56	46.0	50.0	70/66	69	14	1710.80.63.500.1		5	



Je nach Schlauchtyp muss die passende Stabilisierungshülse separat bestellt werden.

Depending on the type of conduit, the stabilising bush must be ordered separately.

Erhältlich mit Dichteinsatz gemäß EN 45545. Bei Anfragen oder Bestellung bitte ein F vor die Artikelnummer setzen.

Available with sealing inserts conformity with EN 45545. When placing an inquiry, prefix the article number by the capital F.

Langes Anschlussgewinde metrisch | Long entry thread metric

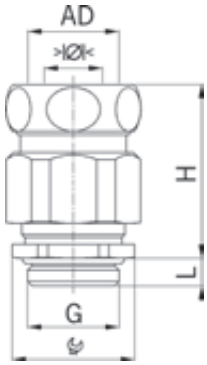

Material: Messing vernickelt  
 Dichtung: TPE  
 O-Ring : NBR  
 Zugentlastung: Ausführung A  
 Einsatztemperatur: -40°C / +100°C  
 Schutzart: Kabelverschraubung IP 68  
 Hinweis: Die Schutzart des Schlauchanschlusses ist abhängig von der Wahl des Schlauchtyps  
 Eigenschaften: Sehr guter Schirmkontakt über die Kontakthülse bei in der Kabelverschraubung endendem Schirmgeflecht

Material: Nickel-plated brass  
 Seal: TPE  
 O-ring : NBR  
 Strain relief: Version A  
 Temperature range: -40°C / +100°C  
 Protection class: Cable gland IP 68  
 Note: The protection class of the conduit fitting depends on the selection of the type of conduit  
 Properties: Excellent shield contact through the contact sleeve with the braided shield terminating in the screwed cable gland





Progress MS Kombi EMC



Einteiliger Dichteinsatz  
 nicht durchgehend isolierend

One-piece sealing insert  
 not overall length insulated

G	AD mm	>Ø< min mm	>Ø< max mm	 mm	H mm	L mm	Art.-Nr.   Art. No.	
M12x1.5	1/4"	4.5	6.0	15/19	35	10	1710.80.12.060.2	25
M16x1.5	5/16"	6.0	8.0	18/21	38	10	1710.80.17.080.2	25
M16x1.5	5/16"	8.0	10.0	18/21	38	10	1710.80.17.100.2	25
M20x1.5	3/8"	8.0	11.0	24/27	42	10	1710.80.20.110.3	25
M20x1.5	1/2"	8.0	11.0	24/29	38	10	1710.80.20.110.4	25
M20x1.5	1/2"	11.0	14.0	24/29	38	10	1710.80.20.140.4	25
M25x1.5	3/4"	13.0	16.0	30/36	52	11	1710.80.25.160.2	25
M25x1.5	3/4"	16.0	19.0	30/36	52	11	1710.80.25.190.2	25
M32x1.5	1"	18.0	21.0	36/45	55	13	1710.80.32.210.2	10
M32x1.5	1"	21.0	25.0	36/45	55	13	1710.80.32.250.2	10
M40x1.5	1 1/4"	24.0	28.5	46/54	62	13	1710.80.40.285.2	10
M40x1.5	1 1/4"	28.5	32.0	46/54	62	13	1710.80.40.320.2	10
M63x1.5	2"	40.0	46.0	70/70	74	14	1710.80.63.460.2	5
M63x1.5	2"	46.0	50.0	70/70	74	14	1710.80.63.500.2	5

Je nach Schlauchtyp muss die passende Stabilisierungshülse separat bestellt werden.

Depending on the type of conduit, the stabilising bush must be ordered separately.

Erhältlich mit Dichteinsatz gemäß EN 45545. Bei Anfragen oder Bestellung bitte ein F vor die Artikelnummer setzen.

Available with sealing inserts conformity with EN 45545. When placing an inquiry, prefix the article number by the capital F.

# AGRO Kombi-Schlauchverschraubung Progress® EMV Messing mit integrierter Kabelverschraubung

## AGRO combination conduit glands Progress® EMC nickel-plated brass with integrated cable gland

### Langes Anschlussgewinde Pg | Long entry thread Pg

Material: Messing vernickelt  
 Dichtung: TPE  
 O-Ring : NBR  
 Einsatztemperatur: -40°C / +100°C  
 Schutzart: Kabelverschraubung IP 68  
 Hinweis: Die Schutzart des Schlauchanschlusses ist abhängig von der Wahl des Schlauchtyps

Material: Nickel-plated brass  
 Seal: TPE  
 O-ring : NBR  
 Temperature range: -40°C / +100°C  
 Protection class: Cable gland IP 68  
 Note: The protection class of the conduit fitting depends on the selection of the type of conduit  
 Properties: Excellent shield contact through the contact sleeve with the braided shield terminating in the screwed cable gland

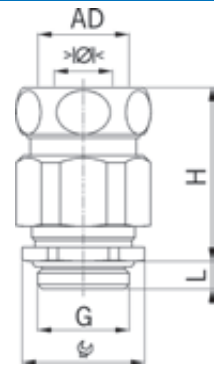

Eigenschaften: Sehr guter Schirmkontakt über die Kontakthülse bei in der Kabelverschraubung endendem Schirmgeflecht

### Progress MS Kombi EMC



Einteiliger Dichteinsatz  
 nicht durchgehend isolierend

One-piece sealing insert  
 not overall length insulated

G	AD mm	>Ø< min mm	>Ø< max mm		H mm	L mm	Art.-Nr.   Art. No.	
Pg 7	10	4.5	6.0	15/17	35	10	1710.80.07.060.1	25
Pg 9	14	6.0	8.0	18/21	40	10	1710.80.09.080.1	25
Pg 9	14	8.0	10.0	18/21	40	10	1710.80.09.100.1	25
Pg 11	17	8.5	12.0	21/25	41	10	1710.80.11.120.1	25
Pg 11	17	5.5	8.5	21/25	41	10	1710.80.11.085.1	25
Pg 13	19	8.0	11.0	24/27	42	10	1710.80.13.110.1	25
Pg 13	19	11.0	14.0	24/27	42	10	1710.80.13.140.1	25
Pg 16	21	8.0	11.0	24/29	43	10	1710.80.16.110.1	25
Pg 16	21	11.0	14.0	24/29	43	10	1710.80.16.140.1	25
Pg 21	27	13.0	16.0	30/36	55	12	1710.80.21.160.1	10
Pg 21	27	16.0	19.0	30/36	55	12	1710.80.21.190.1	10
Pg 29	36	19.0	23.0	38/45	57	12	1710.80.29.230.1	10
Pg 29	36	23.0	25.5	38/45	57	12	1710.80.29.255.1	10
Pg 36	45	25.0	30.5	50/54	62	15	1710.80.36.305.1	5
Pg 36	45	30.5	35.0	50/54	62	15	1710.80.36.350.1	5
Pg 42	45	33.0	37.0	55/54	62	15	1710.80.42.370.1	5
Pg 42	45	37.0	41.0	55/54	62	15	1710.80.42.410.1	5
Pg 48	56	39.0	43.0	65/66	69	15	1710.80.48.430.1	5
Pg 48	56	43.0	46.5	65/66	69	15	1710.80.48.465.1	5



Je nach Schlauchtyp muss die passende Stabilisierungshülse separat bestellt werden.

Depending on the type of conduit, the stabilising bush must be ordered separately.

Erhältlich mit Dichteinsatz gemäß EN 45545. Bei Anfragen oder Bestellung bitte ein F vor die Artikelnummer setzen.

Available with sealing inserts conformity with EN 45545. When placing an inquiry, prefix the article number by the capital F.



# AGRO Adapter Progress® Messing mit integrierter EMV-Kabelverschraubung

## AGRO Adapters Progress® nickel-plated brass with integrated EMC cable gland

Langes Anschlussgewinde metrisch | Long entry thread metric

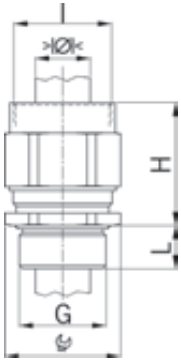

Material: Messing vernickelt  
 Dichtung: TPE  
 O-Ring : NBR  
 Zugentlastung: Ausführung A  
 Einsatztemperatur: -40°C / +100°C  
 Schutzart: Kabelverschraubung IP 68  
 Hinweis: Die Schutzart ist abhängig von der Wahl des Anschlussteils

Material: Nickel-plated brass  
 Seal: TPE  
 O-ring : NBR  
 Strain relief: Version A  
 Temperature range: -40°C / +100°C  
 Protection class: Cable gland IP 68  
 Note: The protection class depends on the selection of the connector



### Progress MS Kombi EMC



Einteiliger Dichteinsatz  
 nicht durchgehend isolierend

One-piece sealing insert  
 not overall length insulated

G	I	> Ø < min mm	> Ø < max mm		H mm	L mm	i info	Art.-Nr.   Art. No.	
M10x1.5	M10x1.5	3.0	4.0	13	32	10	1	1165.80.10.040	50
M10x1.5	M10x1.5	4.0	6.0	13	32	10	1	1165.80.10.060	50
M12x1.5	M12x1.5	4.5	6.0	15	34	10	-	1165.80.12.060	50
M12x1.5	M12x1.5	6.0	7.5	15	34	10	-	1165.80.12.075	50
M16x1.5	M16x1.5	6.0	8.0	18	38	10	-	1165.80.17.080	50
M16x1.5	M16x1.5	8.0	10.0	18	38	10	-	1165.80.17.100	50
M20x1.5	M20x1.5	8.0	11.0	24	40	10	-	1165.80.20.110	25
M20x1.5	M20x1.5	11.0	14.0	24	40	10	-	1165.80.20.140	25
M25x1.5	M25x1.5	13.0	16.0	30	46	11	-	1165.80.25.160	25
M25x1.5	M25x1.5	16.0	19.0	30	46	11	-	1165.80.25.190	25
M32x1.5	M32x1.5	18.0	21.0	36	49	13	-	1165.80.32.210	10
M32x1.5	M32x1.5	21.0	25.0	36	49	13	-	1165.80.32.250	10
M40x1.5	M40x1.5	24.0	28.5	46	51	13	-	1165.80.40.285	5
M40x1.5	M40x1.5	28.5	32.0	46	51	13	-	1165.80.40.320	5
M50x1.5	M50x1.5	33.0	37.0	55	55	14	-	1165.80.50.370	5
M50x1.5	M50x1.5	37.0	41.0	55	55	14	-	1165.80.50.410	5
M63x1.5	M63x1.5	40.0	46.0	70	59	14	-	1165.80.63.460	5
M63x1.5	M63x1.5	46.0	50.0	70	59	14	-	1165.80.63.500	5

1 = Metrisches Regelgewinde

1 = Metric coarse-pitch thread

Erhältlich mit Dichteinsatz gemäß EN 45545. Bei Anfragen oder Bestellung bitte ein F vor die Artikelnummer setzen.

Available with sealing inserts conformity with EN 45545. When placing an inquiry, prefix the article number by the capital F.

# AGRO Adapter Progress® Messing mit integrierter EMV-Kabelverschraubung

## AGRO Adapters Progress® nickel-plated brass with integrated EMC cable gland

Langes Anschlussgewinde Pg | Long entry thread Pg

Material: Messing vernickelt  
 Dichtung: TPE  
 O-Ring : NBR  
 Einsatztemperatur: -40°C / +100°C  
 Schutzart: Kabelverschraubung IP 68  
 Hinweis: Die Schutzart ist abhängig von der Wahl des Schlauchtyps

Material: Nickel-plated brass  
 Seal: TPE  
 O-ring : NBR  
 Temperature range: -40°C / +100°C  
 Protection class: Cable gland IP 68  
 Note: The protection class depends on the selection of the connector

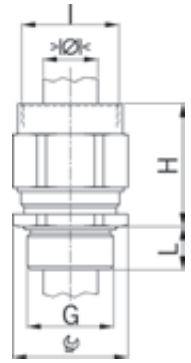

### Progress MS Kombi EMC



Einteiliger Dichteinsatz  
 nicht durchgehend isolierend

One-piece sealing insert  
 not overall length insulated

G	I	> Ø < min mm	> Ø < max mm	EMC	H mm	L mm	Art.-Nr.   Art. No.	
<b>Pg 7</b>	Pg 7	4.0	6.0	15	31	10	<b>1165.80.07.060</b>	50
<b>Pg 7</b>	Pg 7	6.0	7.5	15	31	10	<b>1165.80.07.075</b>	50
<b>Pg 9</b>	Pg 9	6.0	8.0	18	38	10	<b>1165.80.09.080</b>	50
<b>Pg 9</b>	Pg 9	8.0	10.0	18	38	10	<b>1165.80.09.100</b>	50
<b>Pg 11</b>	Pg 11	5.5	8.5	21	38	10	<b>1165.80.11.085</b>	50
<b>Pg 11</b>	Pg 11	8.5	12.0	21	38	10	<b>1165.80.11.120</b>	50
<b>Pg 13</b>	Pg 13	8.0	11.0	24	40	10	<b>1165.80.13.110</b>	25
<b>Pg 13</b>	Pg 13	11.0	14.0	24	40	10	<b>1165.80.13.140</b>	25
<b>Pg 16</b>	Pg 16	8.0	11.0	24	41	10	<b>1165.80.16.110</b>	25
<b>Pg 16</b>	Pg 16	11.0	14.0	24	41	10	<b>1165.80.16.140</b>	25
<b>Pg 21</b>	Pg 21	13.0	16.0	30	47	12	<b>1165.80.21.160</b>	10
<b>Pg 21</b>	Pg 21	16.0	19.0	30	47	12	<b>1165.80.21.190</b>	10
<b>Pg 29</b>	Pg 29	19.0	23.0	38/40	48	12	<b>1165.80.29.230</b>	10
<b>Pg 29</b>	Pg 29	23.0	25.5	38/40	48	12	<b>1165.80.29.255</b>	10
<b>Pg 36</b>	Pg 36	25.0	30.5	50	54	15	<b>1165.80.36.305</b>	10
<b>Pg 36</b>	Pg 36	30.5	35.0	50	54	15	<b>1165.80.36.350</b>	10
<b>Pg 48</b>	Pg 48	39.0	43.0	65	59	15	<b>1165.80.48.430</b>	5
<b>Pg 48</b>	Pg 48	43.0	46.5	65	59	15	<b>1165.80.48.465</b>	5



Erhältlich mit Dichteinsatz gemäß EN 45545. Bei Anfragen oder Bestellung bitte ein F vor die Artikelnummer setzen.

Available with sealing inserts conformity with EN 45545. When placing an inquiry, prefix the article number by the capital F.

# AGRO Kombi-EMV-Schlauchverschraubung für Kupfer-Hohlgeflechte

## AGRO combination EMC conduit gland for copper braidings

Anschlussgewinde metrisch | Entry thread metric

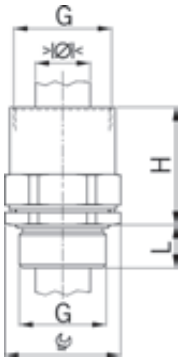

Material: Messing vernickelt  
 O-Ring : NBR  
 Einsatztemperatur: -40°C / +100°C  
 Schutzart: IP 68 (mit Rohrflex®-Ringwellschlauch)

Material: Nickel-plated brass  
 O-ring : NBR  
 Temperature range: -40°C / +100°C  
 Protection class: IP 68 (together with Rohrflex® corrugated tube)



Passend zu ROHRflex® Wellschlauch

Suitable for ROHRflex® corrugated tubings

G	$\text{>}\varnothing\text{<}$			H mm	L mm	Art.-Nr.   Art. No.	
	min mm	max mm					
M20x1.5	2.5	10.0	24	34.5	10	<b>1165.84.20.15</b>	25
M25x1.5	5.0	16.0	30	35.5	11	<b>1165.84.25.21</b>	25
M32x1.5	12.0	20.0	36	36.5	13	<b>1165.84.32.34</b>	25
M40x1.5	16.0	27.0	46	45	13	<b>1165.84.40.34</b>	10
M50x1.5	20.0	35.0	55	46	14	<b>1165.84.50.42</b>	5
M63x1.5	25.0	45.0	70	49	14	<b>1165.84.63.54</b>	5

Dank unserer Kombi-EMV-Schlauchverschraubung für Kupfer-Hohlgeflechte können die Geflechte problemlos auf Masse geführt werden. Eine Kontakthülse garantiert optimale und ausreißfeste Schirmkontaktierung und gleichzeitig eine vibrations sichere Einführung.

Copper braidings may be terminated without any problem with our combination EMC conduit gland. A contact bushing grants optimal shield contact and in the same moment vibration proof leading of cables.



### Druckring Messing zu Schlauchverschraubungen | Thrust collar brass for conduit glands

#### Druckring Messing zu Schlauchverschraubungen

#### Thrust collar brass for conduit glands

Material: Messing vernickelt  
 Einsatzbereich: Zur Erdung sowie als Potenzialausgleich bei Verwendung von Schläuchen mit Metallgeflecht im EMV-Einsatz  
 Einsatztemperatur: -40°C / +200°C

Material: Nickel-plated brass  
 Application: For grounding as well as potential equalization by use of conduits with metal braiding for shielding applications  
 Temperature range: -40°C / +200°C

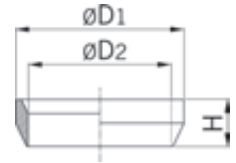

#### Zubehör zu Schlauchverschraubungen

#### Conduit glands accessories

AD mm	ØD1 mm	ØD2 mm	H mm	Art.-Nr.   Art. No.	
10	13	10.2	5.0	5031.034.007	50
14	17	14.5	5.0	5031.034.009	50
17	21	17.2	5.0	5031.034.011	50
19	23	19.2	6.0	5031.034.013	50
21	25	21.3	6.0	5031.034.016	50
27	32	27.3	8.5	5031.034.021	25
36	41	36.3	8.5	5031.034.029	25
45	50	45.3	8.5	5031.034.036	20
56	61	56.3	8.5	5031.034.048	10

Für EMV-Anwendungen Messingdruckring erforderlich!

For EMC applications brass thrust collar necessary!



### Dichtring Kunststoff zu Schlauchverschraubungen | Synthetic thrust collar for conduit glands

#### Dichtring Kunststoff zu Schlauchverschraubungen

#### Synthetic thrust collar for conduit glands

Material: PTFE (Teflon)  
 Einsatzbereich: Bei Verwendung von Schutzschläuchen mit Verschraubungen, geeignet für hohe Temperaturen  
 Einsatztemperatur: -60°C / +300°C

Material: PTFE (teflon)  
 Application: By using tubes with conduit glands suitable for high temperatures  
 Temperature range: -60°C / +300°C

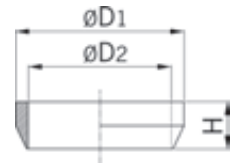

#### Zubehör zu Schlauchverschraubungen

#### Conduit glands accessories

AD mm	ØD1 mm	ØD2 mm	H mm	Art.-Nr.   Art. No.	
10	13	10.3	6.0	5030.013.010	50
14	17	14.3	6.0	5030.013.014	50
17	21	17.3	6.0	5030.013.017	50
19	23	19.3	7.0	5030.013.019	50
21	25	21.3	7.0	5030.013.021	50
27	32	27.4	9.5	5030.013.027	25
36	41	36.4	9.5	5030.013.036	25
45	50	45.4	9.5	5030.013.045	20
56	61	56.5	9.5	5030.013.056	10



# Kabelverschraubung Progress® Kunststoff

## Synthetic cable glands Progress®

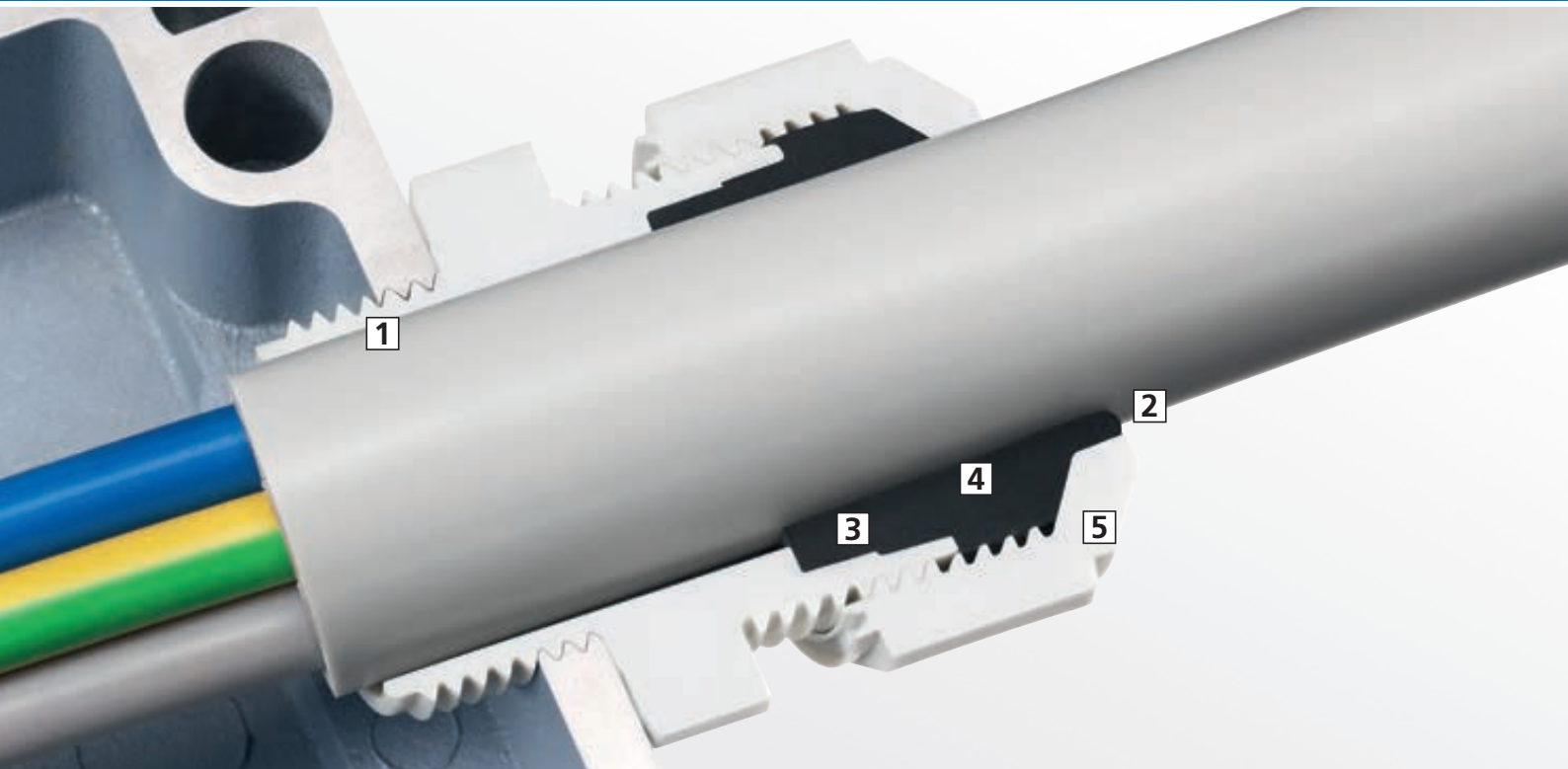

**Kabelverschraubungen Progress®** aus Kunststoff sind bewährte Helfer für die fachgerechte Kabeleinführung in Industrieanlagen.

Die herausragende Kompressionstechnik sorgt für eine hohe Dichtigkeit und eine äußerst kabelschonende Zugentlastung.

### **1 Kurzes oder langes Anschlussgewinde**

Kompressionskabelverschraubungen mit kurzem oder langem Anschlussgewinde in metrischer oder Pg- Ausführung können bei vorhandenem Öffnungsgewinde oder mit Gegenmutter verwendet werden.

### **2 Sichtbare Sicherheit**

Der kleine Wulst des Dichteinsatzes bestätigt das richtige Anzugsmoment.

### **3 Hoher Verdrehschutz**

Der mit Halterippen ausgestattete Dichteinsatz sorgt für einen hohen Verdrehschutz.

### **4 Große Flexibilität**

Zweiteilige Dichteinsätze können in Sekundenschnelle vor Ort auf den vorhandenen Kabeldurchmesser angepasst werden.

### **5 Garantierte Dichtigkeit**

Auf den Dichteinsatz abgestimmte Innenkonturen sorgen für eine zielgerichtete Verformung des Dichteinsatzes und garantieren somit dessen perfekte Abdichtung.

**Synthetic cable glands Progress®** are tried and tested aids for correct cable entry in industrial equipment.

The outstanding compression technology for use everywhere guarantees an effective seal and excellent cable-protecting strain relief.

### **1 Short or long connection thread**

Compression cable glands with short or long connection thread designed as metric or Pg can be used with existing opening threads or with a counter nut.

### **2 Visible safety**

The small bead in the sealing insert confirms the correct tightening torque.

### **3 High distortion protection**

The sealing insert fitted with retaining ribs guarantees high distortion protection.

### **4 Great flexibility**

It only takes a few seconds to adapt the two-part sealing inserts on site to the existing cable diameters.

### **5 Guaranteed seal**

The inner contours of the sealing inserts ensure that they are deformed in such a way as to make the perfect seal.

## Dichteinsätze

### Sealing inserts





**einteiliger Dichteinsatz**  
One-piece sealing insert



**zweiteiliger Dichteinsatz**  
Two-piece sealing insert



Kabelverschraubungen Progress® Kunststoff GFK Synthetic cable glands Progress® GFK	 <p><b>166 - 173</b></p>	1
Kabelverschraubungen Progress® Kunststoff GFK für mehrere Kabel Synthetic cable glands Progress® GFK for installation of multiple cables	 <p><b>174 - 175</b></p>	2



<b>Ausführung / Version</b>		<b>Standard / Standard</b>	<b>für mehrere Kabel / for installation of multiple cables</b>
Kompressionstechnik Compression technology		•	•
<b>Gewinde / Thread</b>			
Anschlussgewinde metrisch Entry thread metric		•	•
Anschlussgewinde Pg Entry thread Pg		•	•
Langes Anschlussgewinde Long entry thread		-	-
<b>Dichteinsatz / Sealing insert</b>			
für Rundkabel for round cables		•	•
für mehrere Kabel (Multi-Dichteinsatz) for multi sealing insert		•	•
einteiliger Dichteinsatz One-piece sealing insert		•	•
zweiteiliger Dichteinsatz Two-piece sealing insert		•	-
<b>Technische Besonderheiten / Technical features</b>			
Vibrationsschutz Vibration resistance		•	•
<b>Farben / Colours</b>			
Hellgrau RAL 7035 Light grey RAL 7035		•	•
Dunkelgrau RAL 7001 Dark grey RAL 7001		•	•
Schwarz RAL 9005 Black RAL 9005		•	•
Weiß RAL 9010 White RAL 9010		•	-
Graugrün RAL 7009 Greygreen RAL 7009		•	-

- 3
- 4
- 5
- 6
- 7
- 8**
- 9
- 10
- 11
- 12



# Kabelverschraubungen Progress® Kunststoff GFK

## Synthetic cable glands Progress® GFK

### Anschlussgewinde metrisch | Entry thread metric

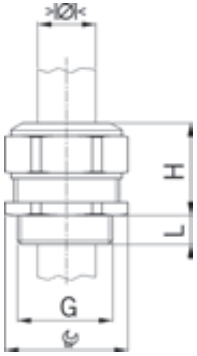

Material: Polyamid  
glasfaserverstärkt  
Eigenschaften: halogenfrei  
Dichtung: TPE  
Zugentlastung: Ausführung A  
Einsatztemperatur: -20°C / +100°C  
Schutzart: IP 68

Material: Polyamide glass fiber  
reinforced  
Properties: Halogen-free  
Seal: TPE  
Strain relief: Version A  
Temperature range: -20°C / +100°C  
Protection class: IP 68



#### Progress GFK

Hellgrau RAL 7035  
Einteiliger Dichteinsatz

Light grey RAL 7035  
One-piece sealing insert

G	> Ø < min mm	> Ø < max mm	mm	H mm	L mm	Art.-Nr.   Art. No.	
M8x1.0	2.5	3.5	12	15.5	10	1571.08.035	50
M8x1.0	3.5	5.0	12	15.5	10	1571.08.050	50
M10x1.0	3.0	4.0	15	18.0	10	1571.10.040	50
M10x1.0	4.0	6.0	15	18.0	10	1571.10.060	50
M12x1.5	3.5	5.0	17	22.0	12	1571.12.050	50
M12x1.5	5.0	6.5	17	22.0	12	1571.12.065	50
M12x1.5	6.5	8.0	17	22.0	12	1571.12.080	50
M16x1.5	4.5	6.0	21	26.0	12	1571.17.060	50
M16x1.5	6.0	8.0	21	26.0	12	1571.17.080	50
M16x1.5	8.0	10.5	21	26.0	12	1571.17.105	50
M20x1.5	6.0	8.0	27	28.0	13	1571.20.080	50
M20x1.5	8.0	11.0	27	28.0	13	1571.20.110	50
M20x1.5	11.0	15.0	27	28.0	13	1571.20.150	50
M25x1.5	9.5	12.5	34	33.0	13	1571.25.125	25
M25x1.5	12.5	16.0	34	33.0	13	1571.25.160	25
M25x1.5	16.0	20.5	34	33.0	13	1571.25.205	25
M32x1.5	14.0	17.0	41	35.0	15	1571.32.170	25
M32x1.5	17.0	21.0	41	35.0	15	1571.32.210	25
M32x1.5	21.0	25.5	41	35.0	15	1571.32.255	25
M40x1.5	20.0	24.0	50	40.0	15	1571.40.240	10
M40x1.5	24.0	28.5	50	40.0	15	1571.40.285	10
M40x1.5	28.5	33.0	50	40.0	15	1571.40.330	10
M50x1.5	29.0	33.0	60	42.0	16	1571.50.330	10
M50x1.5	33.0	37.0	60	42.0	16	1571.50.370	10
M50x1.5	37.0	42.0	60	42.0	16	1571.50.420	10
M63x1.5	35.0	40.0	75	48.0	16	1571.63.400	5
M63x1.5	40.0	46.0	75	48.0	16	1571.63.460	5
M63x1.5	46.0	52.0	75	48.0	16	1571.63.520	5



#### Progress GFK

Hellgrau RAL 7035  
Zweiteiliger Dichteinsatz

Light grey RAL 7035  
Two-piece sealing insert

G	> Ø < min mm	> Ø < max mm	mm	H mm	L mm	Art.-Nr.   Art. No.	
M16x1.5	6.0	10.5	21	26.0	12	1571.17	50
M20x1.5	8.0	15.0	27	28.0	13	1571.20	50
M25x1.5	12.5	20.5	34	33.0	13	1571.25	25
M32x1.5	17.0	25.5	41	35.0	15	1571.32	25
M40x1.5	24.0	33.0	50	40.0	15	1571.40	10
M50x1.5	33.0	42.0	60	42.0	16	1571.50	10
M63x1.5	40.0	52.0	75	48.0	16	1571.63	5



# Kabelverschraubungen Progress® Kunststoff GFK

## Synthetic cable glands Progress® GFK

Anschlussgewinde metrisch | Entry thread metric

Material: Agromid  
glasfaserverstärkt,  
wärmealterungs- und  
schlagzäh modifiziert

Eigenschaften: halogenfrei

Dichtung: TPE

Zugentlastung: Ausführung A

Einsatztemperatur: -30°C / +100°C

Schutzart: IP 68

Material: Agromid glass fiber rein-  
forced, heat aging and  
impact-resistant modified

Properties: Halogen-free

Seal: TPE

Strain relief: Version A

Temperature range: -30°C / +100°C

Protection class: IP 68

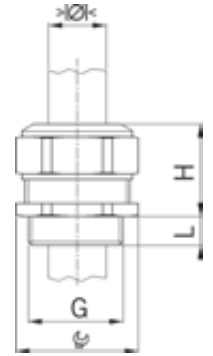

### Progress GFK



Dunkelgrau RAL 7001 Einteiliger Dichteinsatz		Dark grey RAL 7001 One-piece sealing insert		Art.-Nr.   Art. No.			
G	> Ø < min mm	> Ø < max mm	 mm	H mm	L mm		
M8x1.0	2.5	3.5	12	15.5	10	1572.08.035	50
M8x1.0	3.5	5.0	12	15.5	10	1572.08.050	50
M10x1.0	3.0	4.0	15	18.0	10	1572.10.040	50
M10x1.0	4.0	6.0	15	18.0	10	1572.10.060	50
M12x1.5	3.5	5.0	17	22.0	12	1572.12.050	50
M12x1.5	5.0	6.5	17	22.0	12	1572.12.065	50
M12x1.5	6.5	8.0	17	22.0	12	1572.12.080	50
M16x1.5	4.5	6.0	21	26.0	12	1572.17.060	50
M16x1.5	6.0	8.0	21	26.0	12	1572.17.080	50
M16x1.5	8.0	10.5	21	26.0	12	1572.17.105	50
M20x1.5	6.0	8.0	27	28.0	13	1572.20.080	50
M20x1.5	8.0	11.0	27	28.0	13	1572.20.110	50
M20x1.5	11.0	15.0	27	28.0	13	1572.20.150	50
M25x1.5	9.5	12.5	34	33.0	13	1572.25.125	25
M25x1.5	12.5	16.0	34	33.0	13	1572.25.160	25
M25x1.5	16.0	20.5	34	33.0	13	1572.25.205	25
M32x1.5	14.0	17.0	41	35.0	15	1572.32.170	25
M32x1.5	17.0	21.0	41	35.0	15	1572.32.210	25
M32x1.5	21.0	25.5	41	35.0	15	1572.32.255	25
M40x1.5	20.0	24.0	50	40.0	15	1572.40.240	10
M40x1.5	24.0	28.5	50	40.0	15	1572.40.285	10
M40x1.5	28.5	33.0	50	40.0	15	1572.40.330	10
M50x1.5	29.0	33.0	60	42.0	16	1572.50.330	10
M50x1.5	33.0	37.0	60	42.0	16	1572.50.370	10
M50x1.5	37.0	42.0	60	42.0	16	1572.50.420	10
M63x1.5	35.0	40.0	75	48.0	16	1572.63.400	5
M63x1.5	40.0	46.0	75	48.0	16	1572.63.460	5
M63x1.5	46.0	52.0	75	48.0	16	1572.63.520	5



### Progress GFK



Dunkelgrau RAL 7001 Zweiteiliger Dichteinsatz		Dark grey RAL 7001 Two-piece sealing insert		Art.-Nr.   Art. No.			
G	> Ø < min mm	> Ø < max mm	 mm	H mm	L mm		
M16x1.5	6.0	10.5	21	26.0	12	1572.17	50
M20x1.5	8.0	15.0	27	28.0	13	1572.20	50
M25x1.5	12.5	20.5	34	33.0	13	1572.25	25
M32x1.5	17.0	25.5	41	35.0	15	1572.32	25
M40x1.5	24.0	33.0	50	40.0	15	1572.40	10
M50x1.5	33.0	42.0	60	42.0	16	1572.50	10
M63x1.5	40.0	52.0	75	48.0	16	1572.63	5



# Kabelverschraubungen Progress® Kunststoff GFK

## Synthetic cable glands Progress® GFK

### Anschlussgewinde metrisch | Entry thread metric

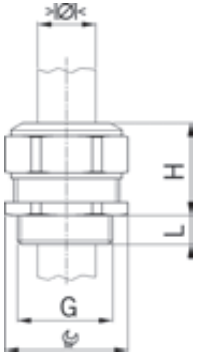

Material: Polyamid  
glasfaserverstärkt  
Eigenschaften: halogenfrei  
Dichtung: TPE  
Zugentlastung: Ausführung A  
Einsatztemperatur: -20°C / +100°C  
Schutzart: IP 68

Material: Polyamide glass fiber  
reinforced  
Properties: Halogen-free  
Seal: TPE  
Strain relief: Version A  
Temperature range: -20°C / +100°C  
Protection class: IP 68



#### Progress GFK

Schwarz RAL 9005  
Einteiliger Dichteinsatz

Black RAL 9005  
One-piece sealing insert

G	> Ø < min mm	> Ø < max mm	mm	H mm	L mm	Art.-Nr.   Art. No.	
M8x1.0	2.5	3.5	12	15.5	10	1540.08.035	50
M8x1.0	3.5	5.0	12	15.5	10	1540.08.050	50
M10x1.0	3.0	4.0	15	18.0	10	1540.10.040	50
M10x1.0	4.0	6.0	15	18.0	10	1540.10.060	50
M12x1.5	3.5	5.0	17	22.0	12	1540.12.050	50
M12x1.5	5.0	6.5	17	22.0	12	1540.12.065	50
M12x1.5	6.5	8.0	17	22.0	12	1540.12.080	50
M16x1.5	4.5	6.0	21	26.0	12	1540.17.060	50
M16x1.5	6.0	8.0	21	26.0	12	1540.17.080	50
M16x1.5	8.0	10.5	21	26.0	12	1540.17.105	50
M20x1.5	6.0	8.0	27	28.0	13	1540.20.080	50
M20x1.5	8.0	11.0	27	28.0	13	1540.20.110	50
M20x1.5	11.0	15.0	27	28.0	13	1540.20.150	50
M25x1.5	9.5	12.5	34	33.0	13	1540.25.125	25
M25x1.5	12.5	16.0	34	33.0	13	1540.25.160	25
M25x1.5	16.0	20.5	34	33.0	13	1540.25.205	25
M32x1.5	14.0	17.0	41	35.0	15	1540.32.170	25
M32x1.5	17.0	21.0	41	35.0	15	1540.32.210	25
M32x1.5	21.0	25.5	41	35.0	15	1540.32.255	25
M40x1.5	20.0	24.0	50	40.0	15	1540.40.240	10
M40x1.5	24.0	28.5	50	40.0	15	1540.40.285	10
M40x1.5	28.5	33.0	50	40.0	15	1540.40.330	10
M50x1.5	29.0	33.0	60	42.0	16	1540.50.330	10
M50x1.5	33.0	37.0	60	42.0	16	1540.50.370	10
M50x1.5	37.0	42.0	60	42.0	16	1540.50.420	10
M63x1.5	35.0	40.0	75	48.0	16	1540.63.400	5
M63x1.5	40.0	46.0	75	48.0	16	1540.63.460	5
M63x1.5	46.0	52.0	75	48.0	16	1540.63.520	5



#### Progress GFK

Schwarz RAL 9005  
Zweiteiliger Dichteinsatz

Black RAL 9005  
Two-piece sealing insert

G	> Ø < min mm	> Ø < max mm	mm	H mm	L mm	Art.-Nr.   Art. No.	
M16x1.5	6.0	10.5	21	26.0	12	1540.17	50
M20x1.5	8.0	15.0	27	28.0	13	1540.20	50
M25x1.5	12.5	20.5	34	33.0	13	1540.25	25
M32x1.5	17.0	25.5	41	35.0	15	1540.32	25
M40x1.5	24.0	33.0	50	40.0	15	1540.40	10
M50x1.5	33.0	42.0	60	42.0	16	1540.50	10
M63x1.5	40.0	52.0	75	48.0	16	1540.63	5



### Anschlussgewinde metrisch | Entry thread metric

Material: Polyamid  
glasfaserverstärkt

Eigenschaften: halogenfrei

Dichtung: TPE

Zugentlastung: Ausführung A

Einsatztemperatur: -20°C / +100°C

Schutzart: IP 68

Material: Polyamide glass fiber  
reinforced

Properties: Halogen-free

Seal: TPE

Strain relief: Version A

Temperature range: -20°C / +100°C

Protection class: IP 68

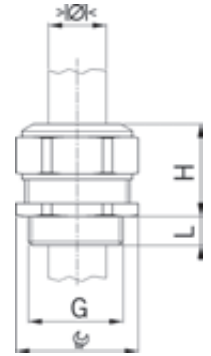

#### Progress GFK



Weiß RAL 9010		White RAL 9010				
Einteiliger Dichteinsatz		One-piece sealing insert				
G	>Ø< min mm	>Ø< max mm	H mm	L mm	Art.-Nr.   Art. No.	
M20x1.5	6.0	8.0	27	28	1520.20.080	50
M20x1.5	8.0	11.0	27	28	1520.20.110	50



#### Progress GFK



Weiß RAL 9010		White RAL 9010				
Zweiteiliger Dichteinsatz		Two-piece sealing insert				
G	>Ø< min mm	>Ø< max mm	H mm	L mm	Art.-Nr.   Art. No.	
M16x1.5	6.0	10.5	21	26	1520.17	50
M20x1.5	8.0	15.0	27	28	1520.20	50
M25x1.5	12.5	20.5	34	33	1520.25	25



#### Progress GFK



Graugrün RAL 7009		Greygreen RAL 7009				
Zweiteiliger Dichteinsatz		Two-piece sealing insert				
G	>Ø< min mm	>Ø< max mm	H mm	L mm	Art.-Nr.   Art. No.	
M16x1.5	6.0	10.5	21	26	1570.17	50
M20x1.5	8.0	15.0	27	28	1570.20	50
M25x1.5	12.5	20.5	34	33	1570.25	25
M32x1.5	17.0	25.5	41	35	1570.32	25



1  
2  
3  
4  
5  
6  
7  
8  
9  
10  
11  
12

# Kabelverschraubungen Progress® Kunststoff GFK

## Synthetic cable glands Progress® GFK

### Anschlussgewinde Pg | Entry thread Pg

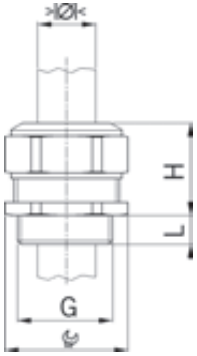

Material: Polyamid  
glasfaserverstärkt  
Eigenschaften: halogenfrei  
Dichtung: TPE  
Einsatztemperatur: -20°C / +100°C  
Schutzart: IP 68

Material: Polyamide glass fiber  
reinforced  
Properties: Halogen-free  
Seal: TPE  
Temperature range: -20°C / +100°C  
Protection class: IP 68



#### Progress GFK

Hellgrau RAL 7035  
Einteiliger Dichteinsatz

Light grey RAL 7035  
One-piece sealing insert

G	>Ø< min mm	>Ø< max mm	mm	H mm	L mm	Art.-Nr.   Art. No.	
Pg 7	3.5	5.0	17	22	12	1571.07.050	50
Pg 7	5.0	6.5	17	22	12	1571.07.065	50
Pg 7	6.5	8.0	17	22	12	1571.07.080	50
Pg 9	4.5	6.0	21	26	12	1571.09.060	50
Pg 9	6.0	8.0	21	26	12	1571.09.080	50
Pg 9	8.0	10.5	21	26	12	1571.09.105	50
Pg 11	4.0	5.5	24	28	12	1571.11.055	50
Pg 11	5.5	8.5	24	28	12	1571.11.085	50
Pg 11	8.5	12.0	24	28	12	1571.11.120	50
Pg 13	6.0	8.0	27	28	13	1571.13.080	50
Pg 13	8.0	11.0	27	28	13	1571.13.110	50
Pg 13	11.0	15.0	27	28	13	1571.13.150	50
Pg 16	6.0	8.0	27	28	13	1571.16.080	50
Pg 16	8.0	11.0	27	28	13	1571.16.110	50
Pg 16	11.0	15.0	27	28	13	1571.16.150	50
Pg 21	9.5	12.5	34	33	13	1571.21.125	25
Pg 21	12.5	16.0	34	33	13	1571.21.160	25
Pg 21	16.0	20.5	34	33	13	1571.21.205	25
Pg 29	16.0	19.0	41	36	13	1571.29.190	25
Pg 29	19.0	23.0	41	36	13	1571.29.230	25
Pg 29	23.0	27.5	41	36	13	1571.29.275	25
Pg 36	21.5	26.0	55	42	16	1571.36.260	10
Pg 36	26.0	30.5	55	42	16	1571.36.305	10
Pg 36	30.5	35.0	55	42	16	1571.36.350	10
Pg 42	29.0	33.0	60	42	16	1571.42.330	10
Pg 42	33.0	37.0	60	42	16	1571.42.370	10
Pg 42	37.0	42.0	60	42	16	1571.42.420	10
Pg 48	32.0	37.0	70	46	16	1571.48.370	5
Pg 48	37.0	43.0	70	46	16	1571.48.430	5
Pg 48	43.0	49.0	70	46	16	1571.48.490	5



#### Progress GFK

Hellgrau RAL 7035  
Zweiteiliger Dichteinsatz

Light grey RAL 7035  
Two-piece sealing insert

G	>Ø< min mm	>Ø< max mm	mm	H mm	L mm	Art.-Nr.   Art. No.	
Pg 9	6.0	10.5	21	26	12	1571.09	50
Pg 11	5.5	12.0	24	28	12	1571.11	50
Pg 13	8.0	15.0	27	28	13	1571.13	50
Pg 16	8.0	15.0	27	28	13	1571.16	50
Pg 21	12.5	20.5	34	33	13	1571.21	25
Pg 29	19.0	27.5	41	36	13	1571.29	25
Pg 36	26.0	35.0	55	42	16	1571.36	10
Pg 42	33.0	42.0	60	42	16	1571.42	10
Pg 48	37.0	49.0	70	46	16	1571.48	5

# Kabelverschraubungen Progress® Kunststoff GFK

## Synthetic cable glands Progress® GFK

Anschlussgewinde Pg | Entry thread Pg

Material: Agromid glasfaserverstärkt, wärmealterungs- und schlagzäh modifiziert  
 Eigenschaften: halogenfrei  
 Dichtung: TPE  
 Einsatztemperatur: -30°C / +100°C  
 Schutzart: IP 68

Material: Agromid glass fiber reinforced, heat aging and impact-resistant modified  
 Properties: Halogen-free  
 Seal: TPE  
 Temperature range: -30°C / +100°C  
 Protection class: IP 68

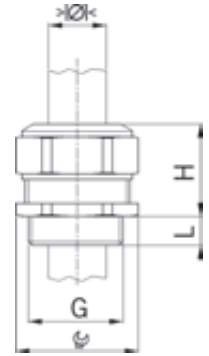

### Progress GFK

Dunkelgrau RAL 7001 Einteiliger Dichteinsatz		Dark grey RAL 7001 One-piece sealing insert				Art.-Nr.   Art. No.	
G	>Ø< min mm	>Ø< max mm		H mm	L mm		
Pg 7	3.5	5.0	17	22	12	1572.07.050	50
Pg 7	5.0	6.5	17	22	12	1572.07.065	50
Pg 7	6.5	8.0	17	22	12	1572.07.080	50
Pg 9	4.5	6.0	21	26	12	1572.09.060	50
Pg 9	6.0	8.0	21	26	12	1572.09.080	50
Pg 9	8.0	10.5	21	26	12	1572.09.105	50
Pg 11	4.0	5.5	24	28	12	1572.11.055	50
Pg 11	5.5	8.5	24	28	12	1572.11.085	50
Pg 11	8.5	12.0	24	28	12	1572.11.120	50
Pg 13	6.0	8.0	27	28	13	1572.13.080	50
Pg 13	8.0	11.0	27	28	13	1572.13.110	50
Pg 13	11.0	15.0	27	28	13	1572.13.150	50
Pg 16	6.0	8.0	27	28	13	1572.16.080	50
Pg 16	8.0	11.0	27	28	13	1572.16.110	50
Pg 16	11.0	15.0	27	28	13	1572.16.150	50
Pg 21	9.5	12.5	34	33	13	1572.21.125	25
Pg 21	12.5	16.0	34	33	13	1572.21.160	25
Pg 21	16.0	20.5	34	33	13	1572.21.205	25
Pg 29	16.0	19.0	41	36	13	1572.29.190	25
Pg 29	19.0	23.0	41	36	13	1572.29.230	25
Pg 29	23.0	27.5	41	36	13	1572.29.275	25
Pg 36	21.5	26.0	55	42	16	1572.36.260	10
Pg 36	26.0	30.5	55	42	16	1572.36.305	10
Pg 36	30.5	35.0	55	42	16	1572.36.350	10
Pg 42	29.0	33.0	60	42	16	1572.42.330	10
Pg 42	33.0	37.0	60	42	16	1572.42.370	10
Pg 42	37.0	42.0	60	42	16	1572.42.420	10
Pg 48	32.0	37.0	70	46	16	1572.48.370	5
Pg 48	37.0	43.0	70	46	16	1572.48.430	5
Pg 48	43.0	49.0	70	46	16	1572.48.490	5



### Progress GFK

Dunkelgrau RAL 7001 Zweiteiliger Dichteinsatz		Dark grey RAL 7001 Two-piece sealing insert				Art.-Nr.   Art. No.	
G	>Ø< min mm	>Ø< max mm		H mm	L mm		
Pg 9	6.0	10.5	21	26	12	1572.09	50
Pg 11	5.5	12.0	24	28	12	1572.11	50
Pg 13	8.0	15.0	27	28	13	1572.13	50
Pg 16	8.0	15.0	27	28	13	1572.16	50
Pg 21	12.5	20.5	34	33	13	1572.21	25
Pg 29	19.0	27.5	41	36	13	1572.29	25
Pg 36	26.0	35.0	55	42	16	1572.36	10
Pg 42	33.0	42.0	60	42	16	1572.42	10
Pg 48	37.0	49.0	70	46	16	1572.48	5





# Kabelverschraubungen Progress® Kunststoff GFK

## Synthetic cable glands Progress® GFK

### Anschlussgewinde Pg | Entry thread Pg

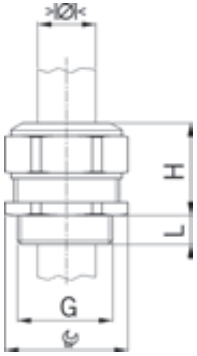

Material: Polyamid  
glasfaserverstärkt  
Eigenschaften: halogenfrei  
Dichtung: TPE  
Einsatztemperatur: -20°C / +100°C  
Schutzart: IP 68

Material: Polyamide glass fiber  
reinforced  
Properties: Halogen-free  
Seal: TPE  
Temperature range: -20°C / +100°C  
Protection class: IP 68



#### Progress GFK



Schwarz RAL 9005  
Einteiliger Dichteinsatz

Black RAL 9005  
One-piece sealing insert

G	$\gt;\varnothing<$ min mm	$\gt;\varnothing<$ max mm	$\varnothing$ mm	H mm	L mm	Art.-Nr.   Art. No.	
Pg 7	3.5	5.0	17	22	12	1540.07.050	50
Pg 7	5.0	6.5	17	22	12	1540.07.065	50
Pg 7	6.5	8.0	17	22	12	1540.07.080	50
Pg 9	4.5	6.0	21	26	12	1540.09.060	50
Pg 9	6.0	8.0	21	26	12	1540.09.080	50
Pg 9	8.0	10.5	21	26	12	1540.09.105	50
Pg 11	4.0	5.5	24	28	12	1540.11.055	50
Pg 11	5.5	8.5	24	28	12	1540.11.085	50
Pg 11	8.5	12.0	24	28	12	1540.11.120	50
Pg 13	6.0	8.0	27	28	13	1540.13.080	50
Pg 13	8.0	11.0	27	28	13	1540.13.110	50
Pg 13	11.0	15.0	27	28	13	1540.13.150	50
Pg 16	6.0	8.0	27	28	13	1540.16.080	50
Pg 16	8.0	11.0	27	28	13	1540.16.110	50
Pg 16	11.0	15.0	27	28	13	1540.16.150	50
Pg 21	9.5	12.5	34	33	13	1540.21.125	25
Pg 21	12.5	16.0	34	33	13	1540.21.160	25
Pg 21	16.0	20.5	34	33	13	1540.21.205	25
Pg 29	16.0	19.0	41	36	13	1540.29.190	25
Pg 29	19.0	23.0	41	36	13	1540.29.230	25
Pg 29	23.0	27.5	41	36	13	1540.29.275	25
Pg 36	21.5	26.0	55	42	16	1540.36.260	10
Pg 36	26.0	30.5	55	42	16	1540.36.305	10
Pg 36	30.5	35.0	55	42	16	1540.36.350	10
Pg 42	29.0	33.0	60	42	16	1540.42.330	10
Pg 42	33.0	37.0	60	42	16	1540.42.370	10
Pg 42	37.0	42.0	60	42	16	1540.42.420	10
Pg 48	32.0	37.0	70	46	16	1540.48.370	5
Pg 48	37.0	43.0	70	46	16	1540.48.430	5
Pg 48	43.0	49.0	70	46	16	1540.48.490	5



#### Progress GFK



Schwarz RAL 9005  
Zweiteiliger Dichteinsatz

Black RAL 9005  
Two-piece sealing insert

G	$\gt;\varnothing<$ min mm	$\gt;\varnothing<$ max mm	$\varnothing$ mm	H mm	L mm	Art.-Nr.   Art. No.	
Pg 9	6.0	10.5	21	26	12	1540.09	50
Pg 11	5.5	12.0	24	28	12	1540.11	50
Pg 13	8.0	15.0	27	28	13	1540.13	50
Pg 16	8.0	15.0	27	28	13	1540.16	50
Pg 21	12.5	20.5	34	33	13	1540.21	25
Pg 29	19.0	27.5	41	36	13	1540.29	25
Pg 36	26.0	35.0	55	42	16	1540.36	10
Pg 42	33.0	42.0	60	42	16	1540.42	10
Pg 48	37.0	49.0	70	46	16	1540.48	5

# Kabelverschraubungen Progress® Kunststoff GFK

## Synthetic cable glands Progress® GFK

Anschlussgewinde Pg | Entry thread Pg

Material: Polyamid  
glasfaserverstärkt  
Eigenschaften: halogenfrei  
Dichtung: TPE  
Einsatztemperatur: -20°C / +100°C  
Schutzart: IP 68

Material: Polyamide glass fiber  
reinforced  
Properties: Halogen-free  
Seal: TPE  
Temperature range: -20°C / +100°C  
Protection class: IP 68

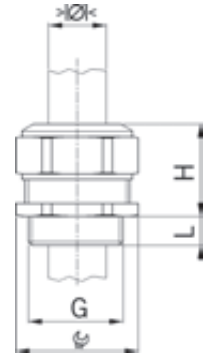

### Progress GFK



Weiß RAL 9010 Einteiliger Dichteinsatz		White RAL 9010 One-piece sealing insert				Art.-Nr.   Art. No.	
G	>Ø< min mm	>Ø< max mm	 mm	H mm	L mm		
Pg 16	6.0	8.0	27	28	13	1520.16.080	50
Pg 16	8.0	11.0	27	28	13	1520.16.110	50



### Progress GFK



Weiß RAL 9010 Zweiteiliger Dichteinsatz		White RAL 9010 Two-piece sealing insert				Art.-Nr.   Art. No.	
G	>Ø< min mm	>Ø< max mm	 mm	H mm	L mm		
Pg 11	5.5	12.0	24	28	12	1520.11	50
Pg 16	8.0	15.0	27	28	13	1520.16	50



### Progress GFK



Graugrün RAL 7009 Zweiteiliger Dichteinsatz		Greygreen RAL 7009 Two-piece sealing insert				Art.-Nr.   Art. No.	
G	>Ø< min mm	>Ø< max mm	 mm	H mm	L mm		
Pg 9	6.0	10.5	21	26	12	1570.09	50
Pg 11	5.5	12.0	24	28	12	1570.11	50
Pg 13	8.0	15.0	27	28	13	1570.13	50
Pg 16	8.0	15.0	27	28	13	1570.16	50
Pg 21	12.5	20.5	34	33	13	1570.21	25
Pg 29	19.0	27.5	41	36	13	1570.29	25



# Kabelverschraubungen Progress® Kunststoff GFK für mehrere Kabel Synthetic cable glands Progress® GFK for installation of multiple cables

Anschlussgewinde metrisch | Entry thread metric

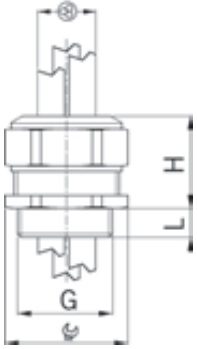

Material: Polyamid  
glasfaserverstärkt  
Eigenschaften: halogenfrei  
Dichtung: TPE  
Zugentlastung: Ausführung A  
Einsatztemperatur: -20°C / +100°C  
Schutzart: IP 68

Material: Polyamide glass fiber  
reinforced  
Properties: Halogen-free  
Seal: TPE  
Strain relief: Version A  
Temperature range: -20°C / +100°C  
Protection class: IP 68



## Progress GFK Multi



Hellgrau RAL 7035  
Einteiliger Dichteinsatz

Light grey RAL 7035  
One-piece sealing insert

G	> Ø < min mm	> Ø < max mm	⊗	mm	H mm	L mm	Art.-Nr.   Art. No.	📦
M16x1.5	2.0	3.0	2	21	26	12	1571.17.2.030	50
M16x1.5	2.5	4.0	2	21	26	12	1571.17.2.040	50
M16x1.5	3.5	5.0	2	21	26	12	1571.17.2.050	50
M20x1.5	3.5	5.0	2	27	28	13	1571.20.2.050	50
M20x1.5	4.5	6.0	2	27	28	13	1571.20.2.060	50
M20x1.5	5.5	7.5	2	27	28	13	1571.20.2.075	50
M20x1.5	3.5	5.0	3	27	28	13	1571.20.3.050	50
M20x1.5	4.5	6.0	3	27	28	13	1571.20.3.060	50
M20x1.5	5.2	6.5	3	27	28	13	1571.20.3.065	50
M20x1.5	3.5	5.0	4	27	28	13	1571.20.4.050	50
M20x1.5	4.5	6.0	4	27	28	13	1571.20.4.060	50
M25x1.5	5.0	7.0	2	34	33	13	1571.25.2.070	25
M25x1.5	6.7	9.0	2	34	33	13	1571.25.2.090	25
M25x1.5	7.7	10.0	2	34	33	13	1571.25.2.100	25
M25x1.5	5.5	7.0	3	34	33	13	1571.25.3.070	25
M25x1.5	6.8	9.0	3	34	33	13	1571.25.3.090	25
M25x1.5	5.5	7.0	4	34	33	13	1571.25.4.070	25
M25x1.5	4.8	6.0	6	34	33	13	1571.25.6.060	25
M32x1.5	9.0	11.5	2	41	35	15	1571.32.2.115	25
M32x1.5	7.0	9.0	3	41	35	15	1571.32.3.090	25
M32x1.5	8.5	10.5	3	41	35	15	1571.32.3.105	25
M32x1.5	7.0	9.0	4	41	35	15	1571.32.4.090	25
M32x1.5	5.8	7.0	6	41	35	15	1571.32.6.070	25

Weitere Ausführungen und Farben auf Anfrage: z.B. dunkelgrau RAL 7001, schwarz RAL 9005, größere Anschluss-  
gewinde

Additional versions and colours are available upon request:  
e.g. dark grey RAL 7001, black RAL 9005, larger entry  
threads

# Kabelverschraubungen Progress® Kunststoff GFK für mehrere Kabel Synthetic cable glands Progress® GFK for installation of multiple cables

Anschlussgewinde Pg | Entry thread Pg

Material: Polyamid  
glasfaserverstärkt  
Eigenschaften: halogenfrei  
Dichtung: TPE  
Einsatztemperatur: -20°C / +100°C  
Schutzart: IP 68

Material: Polyamide glass fiber  
reinforced  
Properties: Halogen-free  
Seal: TPE  
Temperature range: -20°C / +100°C  
Protection class: IP 68

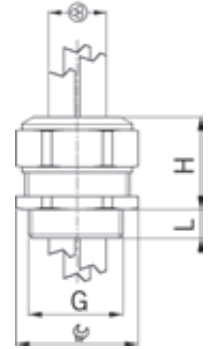

## Progress GFK Multi



Hellgrau RAL 7035 Einteiliger Dichteinsatz		Light grey RAL 7035 One-piece sealing insert				Art.-Nr.   Art. No.		
G	>Ø< min mm	>Ø< max mm			H mm	L mm		
Pg 9	2.0	3.0	2	21	26	12	1571.09.2.030	50
Pg 9	2.5	4.0	2	21	26	12	1571.09.2.040	50
Pg 9	3.5	5.0	2	21	26	12	1571.09.2.050	50
Pg 11	3.5	5.0	2	24	28	12	1571.11.2.050	50
Pg 11	4.5	6.0	2	24	28	12	1571.11.2.060	50
Pg 11	3.5	5.0	3	24	28	12	1571.11.3.050	50
Pg 13	3.5	5.0	2	27	28	13	1571.13.2.050	50
Pg 13	4.5	6.0	2	27	28	13	1571.13.2.060	50
Pg 13	5.5	7.5	2	27	28	13	1571.13.2.075	50
Pg 13	3.5	5.0	3	27	28	13	1571.13.3.050	50
Pg 13	4.5	6.0	3	27	28	13	1571.13.3.060	50
Pg 13	5.2	6.5	3	27	28	13	1571.13.3.065	50
Pg 13	3.5	5.0	4	27	28	13	1571.13.4.050	50
Pg 13	4.5	6.0	4	27	28	13	1571.13.4.060	50
Pg 16	3.5	5.0	2	27	28	13	1571.16.2.050	50
Pg 16	4.5	6.0	2	27	28	13	1571.16.2.060	50
Pg 16	5.5	7.5	2	27	28	13	1571.16.2.075	50
Pg 16	3.5	5.0	3	27	28	13	1571.16.3.050	50
Pg 16	4.5	6.0	3	27	28	13	1571.16.3.060	50
Pg 16	5.2	6.5	3	27	28	13	1571.16.3.065	50
Pg 16	3.5	5.0	4	27	28	13	1571.16.4.050	50
Pg 16	4.5	6.0	4	27	28	13	1571.16.4.060	50
Pg 21	5.0	7.0	2	34	33	13	1571.21.2.070	25
Pg 21	6.7	9.0	2	34	33	13	1571.21.2.090	25
Pg 21	7.7	10.0	2	34	33	13	1571.21.2.100	25
Pg 21	5.5	7.0	3	34	33	13	1571.21.3.070	25
Pg 21	6.8	9.0	3	34	33	13	1571.21.3.090	25
Pg 21	5.5	7.0	4	34	33	13	1571.21.4.070	25
Pg 21	4.8	6.0	6	34	33	13	1571.21.6.060	25
Pg 29	7.5	9.0	3	41	36	13	1571.29.3.090	25

Weitere Ausführungen und Farben auf Anfrage: z.B. dunkelgrau RAL 7001, schwarz RAL 9005, größere Anschlussgewinde  
Additional versions and colours are available upon request: e.g. dark grey RAL 7001, black RAL 9005, larger entry threads



# Kabelverschraubungen Syntec® Messing und Kunststoff

## Cable glands Syntec® nickel-plated brass and synthetics

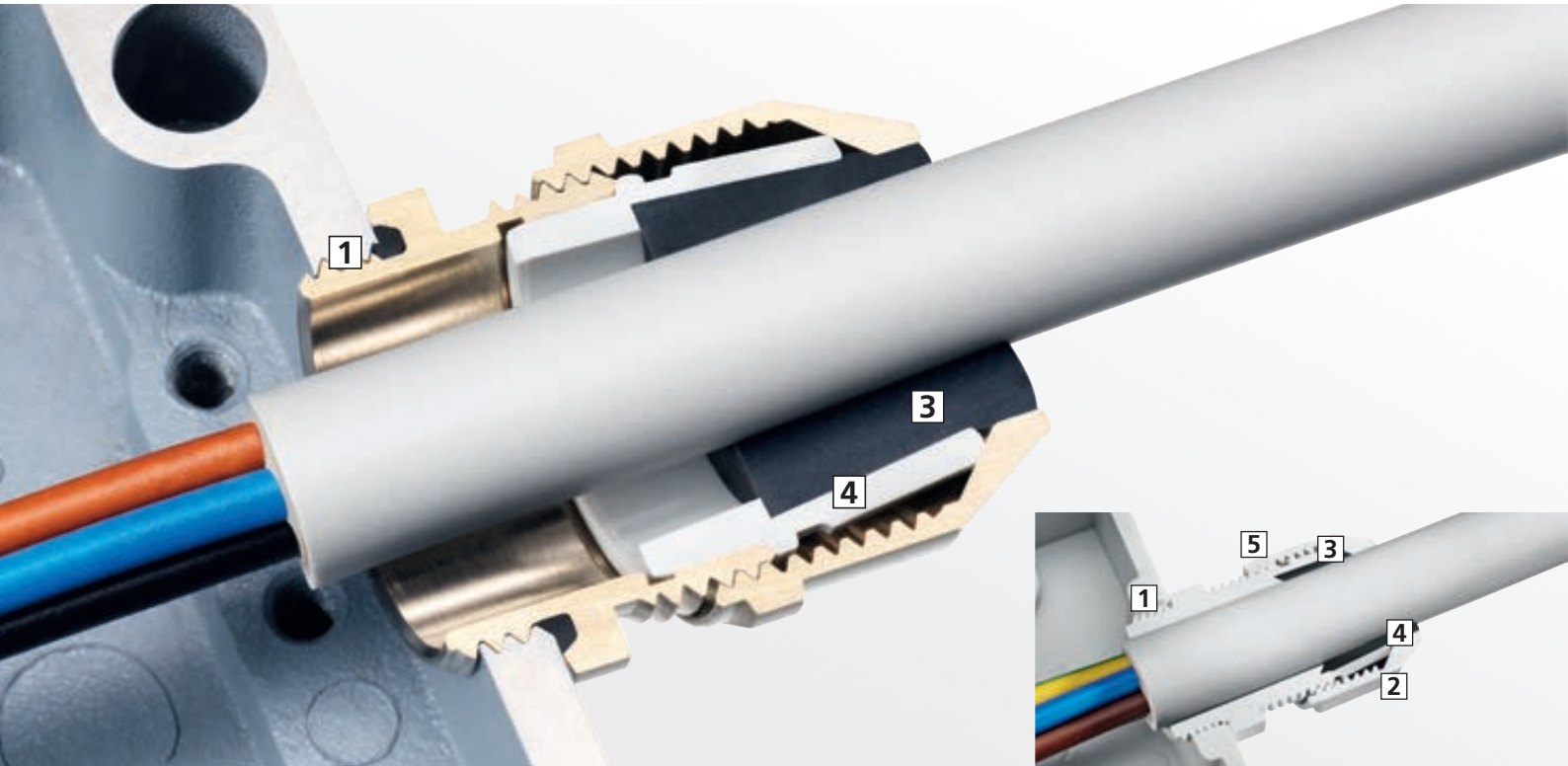

**Kabelverschraubungen Syntec® Messing und Kunststoff** mit innovativer Lamellentechnik. Die beweglichen Gelenklamellen ermöglichen große Klemm- und Dichtbereiche für den flexiblen und sicheren täglichen Einsatz. Die Vorfixierung der Kunststoff Druckmutter erleichtert Überkopf-Montagen sehr.

### 1 Kurzes oder langes Gewinde

Qualitätsverschraubungen mit kurzem oder langem metrischen Gewinde für die sichere Befestigung mit Gewinde oder Gegenmutter.

### 2 Hörbare Sicherheit in Kunststoff

Die Rastnocken der Druckmutter garantieren mit hörbarem „Klick“ immer den vibrations- und rüttelfesten Halt des Kabels.

### 3 Garantierte Dichtigkeit

Die elastischen, umweltbeständigen Dichtringe halten sicher dicht, sind besonders langlebig und garantieren die Schutzart IP 68.

### 4 Patentierte Lamellentechnik

Die von AGRO entwickelte Lamellengeometrie mit beweglichen Gelenklamellen ermöglicht das Einführen verschiedener Durchmesser in die Syntec® Kabelverschraubung bei hervorragender Zugentlastung und exzellentem Verdreherschutz.

### 5 Große Schlüsselflächen in Kunststoff

Der großflächige Sechskant der Druckmutter bietet immer sicheren und festen Halt beim Andrehen von Hand und Festziehen mit dem Werkzeug.

**AGRO Cable glands Syntec® nickel-plated brass and synthetic material** with innovative lamellar technology. The movable articulated lamellas provide large clamping and sealing areas for secure and flexible everyday use. The pre-fixation of the synthetic compression nut allows for overhead installation.

### 1 Short or long thread

Quality cable glands with a short or long metrical thread for secure fastening with thread or counter nut.

### 2 Audible reliability in synthetic material

The snap-in pins of the compression nuts give an audible „click“ that guarantees vibration- and shake-proof hold.

### 3 Guaranteed tightness

The elastic sealing rings with good chemical resistance provide a reliable seal, are particularly durable and offer guaranteed protection to protection class IP 68.

### 4 Patented lamellar technology

The AGRO-developed lamellar geometry with movable jointed lamellar support the insertion of varying diameters into the Syntec® cable gland and ensure outstanding strain relief and distortion protection.

### 5 Large spanner flats in synthetic material

The large hexagonal element of the screw-down nuts ensures consistently reliable and secure hold when turning by hand and tightening with the tool.

## Trapezförmige Gelenklamellen

### Trapezoidal lamellas



Die patentierte, einzigartige Lamellentechnik garantiert eine hervorragende Zugentlastung.

The patented, unique lamellar technology guarantees an excellent strain relief.



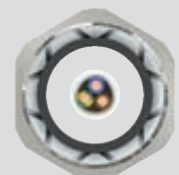

Die trapezförmigen Lamellen gleiten beim Anziehen der Kabelverschraubung ineinander und verpressen das Kabel verdrehsicher in ein Sechseck.

When tightening the compression nut of the cable gland, the single lamellas slide into a hexagon and thus compress the cable in a torsion proof way.





Kabelverschraubungen Syntec® Messing mit Lamellentechnik Cable glands Syntec® nickel-plated brass with lamellar technology	 178 - 179
Kabelverschraubungen Syntec® Kunststoff mit Lamellentechnik Synthetic cable glands Syntec® with lamellar technology	 180 - 185
Kabelverschraubungen Syntec® Kunststoff mit Lamellentechnik und Knickschutz Synthetic Syntec® cable glands with lamellar technology and antikink nozzle	 186 - 189

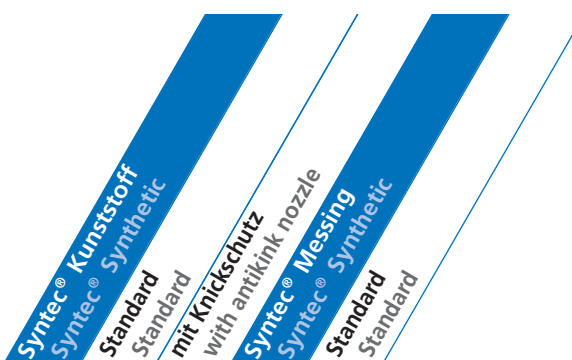

Ausführung / Version	Syntec® Kunststoff Standard	mit Knickschutz with antikink nozzle	Syntec® Messing Standard
Lamellentechnik Lamellar technology	•	•	•
<b>Gewinde / Thread</b>			
Anschlussgewinde Pg Entry thread Pg	•	•	•
Anschlussgewinde NPT Entry thread NPT	•	•	-
Kurzes Anschlussgewinde metrisch Short entry thread metric	•	•	•
Langes Anschlussgewinde metrisch Long entry thread metric	•	•	•
<b>Dichteinsatz / Sealing insert</b>			
für Rundkabel for round cables	•	•	•
Standard Dichtring (TPE/CR) Standard sealing ring (TPE/CR)	•	•	•
<b>Technische Besonderheiten / Technical features</b>			
erhöhter Vibrationsschutz Increased Vibration resistance	•	•	-
Knickschutz Antikink coil	-	•	-
<b>Farben / Colours</b>			
Hellgrau RAL 7035 Light grey RL 7035	•	•	-
Dunkelgrau RAL 7001 Dark grey RAL 7001	•	•	-
Schwarz RAL 9005 Black RAL 9005	•	•	-
Messing vernickelt Nickel-plated brass	-	-	•

1  
2  
3  
4  
5  
6  
7  
8  
9  
10  
11  
12



# Kabelverschraubungen Syntec® Messing mit Lamellentechnik

## Cable glands Syntec® nickel-plated brass with lamellar technology

### Kurzes Anschlussgewinde metrisch | Short entry thread metric

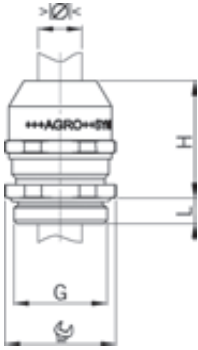

Material: Messing vernickelt  
 Dichtring: TPE  
 O-Ring: NBR  
 Lamelleneinsatz: Polyamid PA 6  
 Einsatztemperatur: -40°C / +100°C  
 Schutzart: IP 68

Material: Nickel-plated brass  
 Sealing ring: TPE  
 O-ring: NBR  
 Lamellar insert: Polyamide PA 6  
 Temperature range: -40°C / +100°C  
 Protection class: IP 68



#### SYNTEC MS



Einteiliger Dichtring  
 nicht durchgehend isolierend

One-piece sealing ring  
 not overall length insulated

G	> Ø < min mm	> Ø < max mm	 mm	H mm	L mm	Art.-Nr.   Art. No.	
M12x1.5	1.0	5.0	15	17	5	1045.12.050	50
M12x1.5	3.0	7.0	15	17	5	1045.12.070	50
M16x1.5	2.0	6.0	18	20	5	1045.17.060	50
M16x1.5	4.5	10.0	18	20	5	1045.17.100	50
M20x1.5	3.5	8.0	22	25	6	1045.20.080	50
M20x1.5	7.0	13.0	22	25	6	1045.20.130	50
M25x1.5	5.0	11.0	28	31	7	1045.25.110	25
M25x1.5	10.0	17.0	28	31	7	1045.25.170	25
M32x1.5	7.0	15.0	36	33	8	1045.32.150	25
M32x1.5	13.0	21.0	36	33	8	1045.32.210	25
M40x1.5	15.0	23.0	46	40	8	1045.40.230	10
M40x1.5	19.0	28.0	46	40	8	1045.40.280	10
M50x1.5	20.0	29.0	55	40	9	1045.50.290	5
M50x1.5	25.0	35.0	55	40	9	1045.50.350	5
M63x1.5	28.0	39.0	70	43	10	1045.63.390	5
M63x1.5	35.0	48.0	70	43	10	1045.63.480	5

### Langes Anschlussgewinde metrisch | Long entry thread metric



#### SYNTEC MS



Einteiliger Dichtring  
 nicht durchgehend isolierend

One-piece sealing ring  
 not overall length insulated

G	> Ø < min mm	> Ø < max mm	 mm	H mm	L mm	Art.-Nr.   Art. No.	
M12x1.5	1.0	5.0	15	17	12	1145.12.050	50
M12x1.5	3.0	7.0	15	17	12	1145.12.070	50
M16x1.5	2.0	6.0	18	20	12	1145.17.060	50
M16x1.5	4.5	10.0	18	20	12	1145.17.100	50
M20x1.5	3.5	8.0	22	25	12	1145.20.080	50
M20x1.5	7.0	13.0	22	25	12	1145.20.130	50
M25x1.5	5.0	11.0	28	31	12	1145.25.110	25
M25x1.5	10.0	17.0	28	31	12	1145.25.170	25
M32x1.5	7.0	15.0	36	33	15	1145.32.150	25
M32x1.5	13.0	21.0	36	33	15	1145.32.210	25
M40x1.5	15.0	23.0	46	40	15	1145.40.230	10
M40x1.5	19.0	28.0	46	40	15	1145.40.280	10
M50x1.5	20.0	29.0	55	40	15	1145.50.290	5
M50x1.5	25.0	35.0	55	40	15	1145.50.350	5
M63x1.5	28.0	39.0	70	43	15	1145.63.390	5
M63x1.5	35.0	48.0	70	43	15	1145.63.480	5
M63x1.5	44.0	55.0	80	43	15	1145.63.550	5

# Kabelverschraubungen Syntec® Messing mit Lamellentechnik

## Cable glands Syntec® nickel-plated brass with lamellar technology

### Kurzes Anschlussgewinde Pg | Short entry thread Pg

Material: Messing vernickelt  
 Dichtring: TPE  
 O-Ring : NBR  
 Lamelleneinsatz: Polyamid PA 6  
 Einsatztemperatur: -40°C / +100°C  
 Schutzart: IP 68

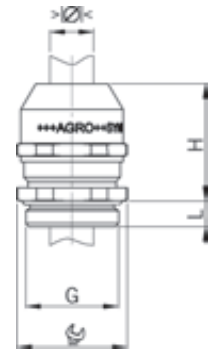

Material: Nickel-plated brass  
 Sealing ring: TPE  
 O-ring : NBR  
 Lamellar insert: Polyamide PA 6  
 Temperature range: -40°C / +100°C  
 Protection class: IP 68



### SYNTEC MS

Einteiliger Dichtring  
 nicht durchgehend isolierend

One-piece sealing ring  
 not overall length insulated

G	>Ø< min mm	>Ø< max mm		H mm	L mm	Art.-Nr.   Art. No.	
Pg 7	1.0	5.0	15	17	5	1045.07.050	50
Pg 7	3.0	7.0	15	17	5	1045.07.070	50
Pg 9	2.0	6.0	18	20	6	1045.09.060	50
Pg 9	4.5	10.0	18	20	6	1045.09.100	50
Pg 11	3.5	8.0	22	25	6	1045.11.080	50
Pg 11	7.0	13.0	22	25	6	1045.11.130	50
Pg 13	3.5	8.0	22	25	6.5	1045.13.080	50
Pg 13	7.0	13.0	22	25	6.5	1045.13.130	50
Pg 16	3.5	8.0	24	25	6.5	1045.16.080	50
Pg 16	5.0	11.0	24	25	6.5	1045.16.110	25
Pg 16	7.0	13.0	28	31	6.5	1045.16.130	50
Pg 16	10.0	17.0	28	31	6.5	1045.16.170	25
Pg 21	7.0	15.0	36	33	7	1045.21.150	25
Pg 21	13.0	21.0	36	33	7	1045.21.210	25
Pg 29	15.0	23.0	46	40	8	1045.29.230	10
Pg 29	19.0	28.0	46	40	8	1045.29.280	10
Pg 36	20.0	29.0	55	40	9	1045.36.290	5
Pg 36	25.0	35.0	55	40	9	1045.36.350	5
Pg 42	20.0	29.0	55	40	10	1045.42.290	5
Pg 42	25.0	35.0	55	40	10	1045.42.350	5
Pg 48	28.0	39.0	70	43	10	1045.48.390	5
Pg 48	35.0	48.0	70	43	10	1045.48.480	5



# Kabelverschraubungen Syntec® Kunststoff mit Lamellentechnik

## Synthetic cable glands Syntec® with lamellar technology

### Kurzes Anschlussgewinde metrisch | Short entry thread metric

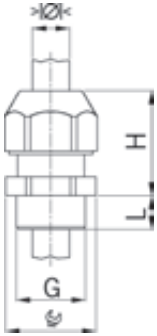

Material: Polyamid PA 6  
 Eigenschaften: halogenfrei  
 Dichtring: TPE oder CR (Neopren)  
 Einsatztemperatur: -30°C / +100°C  
 Schutzart: IP 68

Material: Polyamide PA 6  
 Properties: Halogen-free  
 Sealing ring: TPE or CR (Neoprene)  
 Temperature range: -30°C / +100°C  
 Protection class: IP 68



#### SYNTEC

Hellgrau RAL 7035  
 Einteiliger Dichtring

Light grey RAL 7035  
 One-piece sealing ring

G	>Ø< min mm	>Ø< max mm	 mm	H mm	L mm	Art.-Nr.   Art. No.	
M12x1.5	2.5	6.5	15	21	6	1555.12.06	100
M16x1.5	2.0	6.0	19	25	8	1555.17.06	50
M16x1.5	4.5	10.0	19	25	8	1555.17.10	50
M20x1.5	3.5	8.0	24	29	9	1555.20.08	50
M20x1.5	7.0	13.0	24	29	9	1555.20.13	50
M25x1.5	5.0	11.0	29	38	10	1555.25.11	25
M25x1.5	10.0	17.0	29	38	10	1555.25.17	25
M32x1.5	17.0	25.0	42	36	10	1555.32.25	20



#### SYNTEC

Dunkelgrau RAL 7001  
 Einteiliger Dichtring

Dark grey RAL 7001  
 One-piece sealing ring

G	>Ø< min mm	>Ø< max mm	 mm	H mm	L mm	Art.-Nr.   Art. No.	
M12x1.5	2.5	6.5	15	21	6	1556.12.06	100
M16x1.5	2.0	6.0	19	25	8	1556.17.06	50
M16x1.5	4.5	10.0	19	25	8	1556.17.10	50
M20x1.5	3.5	8.0	24	29	9	1556.20.08	50
M20x1.5	7.0	13.0	24	29	9	1556.20.13	50
M25x1.5	5.0	11.0	29	38	10	1556.25.11	25
M25x1.5	10.0	17.0	29	38	10	1556.25.17	25
M32x1.5	17.0	25.0	42	36	10	1556.32.25	20



#### SYNTEC

Schwarz RAL 9005  
 Einteiliger Dichtring

Black RAL 9005  
 One-piece sealing ring

G	>Ø< min mm	>Ø< max mm	 mm	H mm	L mm	Art.-Nr.   Art. No.	
M12x1.5	2.5	6.5	15	21	6	1545.12.06	100
M16x1.5	2.0	6.0	19	25	8	1545.17.06	50
M16x1.5	4.5	10.0	19	25	8	1545.17.10	50
M20x1.5	3.5	8.0	24	29	9	1545.20.08	50
M20x1.5	7.0	13.0	24	29	9	1545.20.13	50
M25x1.5	5.0	11.0	29	38	10	1545.25.11	25
M25x1.5	10.0	17.0	29	38	10	1545.25.17	25
M32x1.5	17.0	25.0	42	36	10	1545.32.25	20

# Kabelverschraubungen Syntec® Kunststoff mit Lamellentechnik Synthetic cable glands Syntec® with lamellar technology

Langes Anschlussgewinde metrisch | Long entry thread metric

Material: Polyamid PA 6  
Eigenschaften: halogenfrei  
Dichtring: TPE oder CR (Neopren)  
Einsatztemperatur: -30°C / +100°C  
Schutzart: IP 68

Material: Polyamide PA 6  
Properties: Halogen-free  
Sealing ring: TPE or CR (Neoprene)  
Temperature range: -30°C / +100°C  
Protection class: IP 68

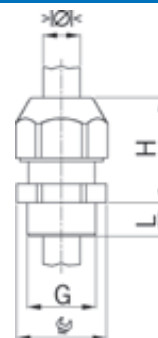

## SYNTEC



Hellgrau RAL 7035 Einteiliger Dichtring		Light grey RAL 7035 One-piece sealing ring				
G	>Ø< min mm	>Ø< max mm	H mm	L mm	Art.-Nr.   Art. No.	
M12x1.5	2.5	6.5	15	21	1555.12.1.06	100
M16x1.5	2.0	6.0	19	25	1555.17.1.06	50
M16x1.5	4.5	10.0	19	25	1555.17.1.10	50
M20x1.5	3.5	8.0	24	29	1555.20.1.08	50
M20x1.5	7.0	13.0	24	29	1555.20.1.13	50
M25x1.5	5.0	11.0	29	38	1555.25.1.11	25
M25x1.5	10.0	17.0	29	38	1555.25.1.17	25
M32x1.5	17.0	25.0	42	36	1555.32.1.25	20
M40x1.5	22.0	33.0	53	48	1555.40.1.33	10
M50x1.5	28.0	38.0	60	48	1555.50.1.38	5
M63x1.5	32.0	44.0	65	49	1555.63.1.44	5



## SYNTEC



Dunkelgrau RAL 7001 Einteiliger Dichtring		Dark grey RAL 7001 One-piece sealing ring				
G	>Ø< min mm	>Ø< max mm	H mm	L mm	Art.-Nr.   Art. No.	
M12x1.5	2.5	6.5	15	21	1556.12.1.06	100
M16x1.5	2.0	6.0	19	25	1556.17.1.06	50
M16x1.5	4.5	10.0	19	25	1556.17.1.10	50
M20x1.5	3.5	8.0	24	29	1556.20.1.08	50
M20x1.5	7.0	13.0	24	29	1556.20.1.13	50
M25x1.5	5.0	11.0	29	38	1556.25.1.11	25
M25x1.5	10.0	17.0	29	38	1556.25.1.17	25
M32x1.5	17.0	25.0	42	36	1556.32.1.25	20
M40x1.5	22.0	33.0	53	48	1556.40.1.33	10
M50x1.5	28.0	38.0	60	48	1556.50.1.38	5
M63x1.5	32.0	44.0	65	49	1556.63.1.44	5



# Kabelverschraubungen Syntec® Kunststoff mit Lamellentechnik

## Synthetic cable glands Syntec® with lamellar technology

Langes Anschlussgewinde metrisch | Long entry thread metric

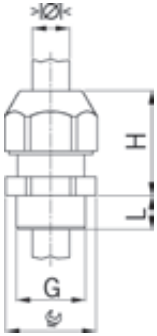

Material: Polyamid PA 6  
 Eigenschaften: halogenfrei  
 Dichtring: TPE oder CR (Neopren)  
 Einsatztemperatur: -30°C / +100°C  
 Schutzart: IP 68

Material: Polyamide PA 6  
 Properties: Halogen-free  
 Sealing ring: TPE or CR (Neoprene)  
 Temperature range: -30°C / +100°C  
 Protection class: IP 68



### SYNTEC

Schwarz RAL 9005  
 Einteiliger Dichtring

Black RAL 9005  
 One-piece sealing ring



G	>Ø< min mm	>Ø< max mm	 mm	H mm	L mm	Art.-Nr.   Art. No.	
M12x1.5	2.5	6.5	15	21	12	1545.12.1.06	100
M16x1.5	2.0	6.0	19	25	15	1545.17.1.06	50
M16x1.5	4.5	10.0	19	25	15	1545.17.1.10	50
M20x1.5	3.5	8.0	24	29	15	1545.20.1.08	50
M20x1.5	7.0	13.0	24	29	15	1545.20.1.13	50
M25x1.5	5.0	11.0	29	38	15	1545.25.1.11	25
M25x1.5	10.0	17.0	29	38	15	1545.25.1.17	25
M32x1.5	17.0	25.0	42	36	15	1545.32.1.25	20
M40x1.5	22.0	33.0	53	48	15	1545.40.1.33	10
M50x1.5	28.0	38.0	60	48	15	1545.50.1.38	5
M63x1.5	32.0	44.0	65	49	16	1545.63.1.44	5

# Kabelverschraubungen Syntec® Kunststoff mit Lamellentechneik

## Synthetic cable glands Syntec® with lamellar technology

Anschlussgewinde Pg | Entry thread Pg

Material: Polyamid PA 6  
 Eigenschaften: halogenfrei  
 Dichtring: CR (Neopren)  
 Einsatztemperatur: -30°C / +100°C  
 Schutzart: IP 68

Material: Polyamide PA 6  
 Properties: Halogen-free  
 Sealing ring: CR (neoprene)  
 Temperature range: -30°C / +100°C  
 Protection class: IP 68

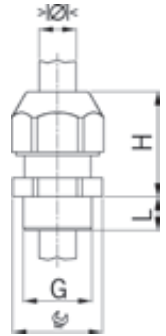

### SYNTEC



Hellgrau RAL 7035 Einteiliger Dichtring		Light grey RAL 7035 One-piece sealing ring				Art.-Nr.   Art. No.	
G	>Ø< min mm	>Ø< max mm	 mm	H mm	L mm		
Pg 7	2.5	6.5	15	21	8	1555.07.06	100
Pg 9	3.0	8.0	19	23	8	1555.09.08	50
Pg 11	2.0	7.0	22	25	8	1555.11.07	50
Pg 11	4.0	10.0	22	25	8	1555.11.10	50
Pg 13	3.0	7.0	24	26	9	1555.13.07	50
Pg 13	5.5	12.0	24	26	9	1555.13.12	50
Pg 16	5.0	11.0	27	30	10	1555.16.11	50
Pg 16	8.5	14.0	27	30	10	1555.16.14	50
Pg 21	6.5	14.0	33	35	11	1555.21.14	25
Pg 21	11.0	18.0	33	35	11	1555.21.18	25
Pg 29	17.0	25.0	42	36	11	1555.29.25	20
Pg 36	22.0	33.0	53	48	15	1555.36.33	10
Pg 42	28.0	38.0	60	48	15	1555.42.38	5
Pg 48	32.0	44.0	65	48	15	1555.48.44	5



### SYNTEC



Dunkelgrau RAL 7001 Einteiliger Dichtring		Dark grey RAL 7001 One-piece sealing ring				Art.-Nr.   Art. No.	
G	>Ø< min mm	>Ø< max mm	 mm	H mm	L mm		
Pg 7	2.5	6.5	15	21	8	1556.07.06	100
Pg 9	3.0	8.0	19	23	8	1556.09.08	50
Pg 11	2.0	7.0	22	25	8	1556.11.07	50
Pg 11	4.0	10.0	22	25	8	1556.11.10	50
Pg 13	3.0	7.0	24	26	9	1556.13.07	50
Pg 13	5.5	12.0	24	26	9	1556.13.12	50
Pg 16	5.0	11.0	27	30	10	1556.16.11	50
Pg 16	8.5	14.0	27	30	10	1556.16.14	50
Pg 21	6.5	14.0	33	35	11	1556.21.14	25
Pg 21	11.0	18.0	33	35	11	1556.21.18	25
Pg 29	17.0	25.0	42	36	11	1556.29.25	20
Pg 36	22.0	33.0	53	48	15	1556.36.33	10
Pg 42	28.0	38.0	60	48	15	1556.42.38	5
Pg 48	32.0	44.0	65	48	15	1556.48.44	5





# Kabelverschraubungen Syntec® Kunststoff mit Lamellentechnik

## Synthetic cable glands Syntec® with lamellar technology

### Anschlussgewinde Pg | Entry thread Pg

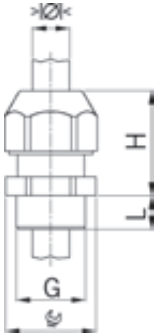

Material: Polyamid PA 6  
 Eigenschaften: halogenfrei  
 Dichtring: CR (Neopren)  
 Einsatztemperatur: -30°C / +100°C  
 Schutzart: IP 68

Material: Polyamide PA 6  
 Properties: Halogen-free  
 Sealing ring: CR (neoprene)  
 Temperature range: -30°C / +100°C  
 Protection class: IP 68





#### SYNTEC

Schwarz RAL 9005  
 Einteiliger Dichtring

Black RAL 9005  
 One-piece sealing ring



G	>Ø< min mm	>Ø< max mm	 mm	H mm	L mm	Art.-Nr.   Art. No.	
Pg 7	2.5	6.5	15	21	8	1545.07.06	100
Pg 9	3.0	8.0	19	23	8	1545.09.08	50
Pg 11	2.0	7.0	22	25	8	1545.11.07	50
Pg 11	4.0	10.0	22	25	8	1545.11.10	50
Pg 13	3.0	7.0	24	26	9	1545.13.07	50
Pg 13	5.5	12.0	24	26	9	1545.13.12	50
Pg 16	5.0	11.0	27	30	10	1545.16.11	50
Pg 16	8.5	14.0	27	30	10	1545.16.14	50
Pg 21	6.5	14.0	33	35	11	1545.21.14	25
Pg 21	11.0	18.0	33	35	11	1545.21.18	25
Pg 29	17.0	25.0	42	36	11	1545.29.25	20
Pg 36	22.0	33.0	53	48	15	1545.36.33	10
Pg 42	28.0	38.0	60	48	15	1545.42.38	5
Pg 48	32.0	44.0	65	48	15	1545.48.44	5

# Kabelverschraubungen Syntec® Kunststoff mit Lamellentechnik Synthetic cable glands Syntec® with lamellar technology

## Anschlussgewinde NPT | Entry thread NPT

Material: Polyamid PA 6  
Eigenschaften: halogenfrei  
Dichtring: CR (Neopren)  
Einsatztemperatur: -30°C / +100°C  
Schutzart: IP 54  
Weitere Schutzart: IP 68, wenn Anschlussgewinde abgedichtet

Material: Polyamide PA 6  
Properties: Halogen-free  
Sealing ring: CR (neoprene)  
Temperature range: -30°C / +100°C  
Protection class: IP 54  
Further protection: IP 68, if the entry thread is sealed

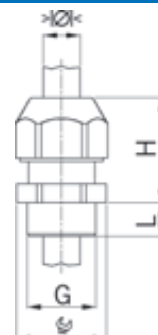

### SYNTEC



Hellgrau RAL 7035 Einteiliger Dichtring		Light grey RAL 7035 One-piece sealing ring				
G	>Ø< min mm	>Ø< max mm	mm	H mm	L mm	Art.-Nr.   Art. No.
NPT 3/8"	3.0	8.0	19/22	23	15	1555.N0375.08 50
NPT 1/2"	3.0	7.0	24	26	15	1555.N0500.07 50
NPT 1/2"	5.5	12.0	24	26	15	1555.N0500.12 50
NPT 3/4"	6.5	14.0	33	35	15	1555.N0750.14 25
NPT 3/4"	11.0	18.0	33	35	15	1555.N0750.18 25
NPT 1"	17.0	22.0	42	36	15	1555.N1000.22 20



### SYNTEC



Dunkelgrau RAL 7001 Einteiliger Dichtring		Dark grey RAL 7001 One-piece sealing ring				
G	>Ø< min mm	>Ø< max mm	mm	H mm	L mm	Art.-Nr.   Art. No.
NPT 3/8"	3.0	8.0	19/22	23	15	1556.N0375.08 50
NPT 1/2"	3.0	7.0	24	26	15	1556.N0500.07 50
NPT 1/2"	5.5	12.0	24	26	15	1556.N0500.12 50
NPT 3/4"	6.5	14.0	33	35	15	1556.N0750.14 25
NPT 3/4"	11.0	18.0	33	35	15	1556.N0750.18 25
NPT 1"	17.0	22.0	42	36	15	1556.N1000.22 20



### SYNTEC



Schwarz RAL 9005 Einteiliger Dichtring		Black RAL 9005 One-piece sealing ring				
G	>Ø< min mm	>Ø< max mm	mm	H mm	L mm	Art.-Nr.   Art. No.
NPT 3/8"	3.0	8.0	19/22	23	15	1545.N0375.08 50
NPT 1/2"	3.0	7.0	24	26	15	1545.N0500.07 50
NPT 1/2"	5.5	12.0	24	26	15	1545.N0500.12 50
NPT 3/4"	6.5	14.0	33	35	15	1545.N0750.14 25
NPT 3/4"	11.0	18.0	33	35	15	1545.N0750.18 25
NPT 1"	17.0	22.0	42	36	15	1545.N1000.22 20



# Kabelverschraubungen Syntec® Kunststoff mit Lamellentechnik und Knickschutz Synthetic Syntec® cable glands with lamellar technology and anti-kink nozzle

## Kurzes Anschlussgewinde metrisch | Short entry thread metric

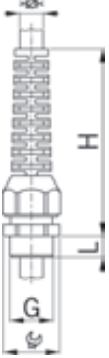

Material: Polyamid PA 6  
Eigenschaften: halogenfrei  
Dichtring: CR (Neopren)  
Einsatztemperatur: -30°C / +100°C  
Schutzart: IP 68

Material: Polyamide PA 6  
Properties: Halogen-free  
Sealing ring: CR (neoprene)  
Temperature range: -30°C / +100°C  
Protection class: IP 68

### SYNTEC mit Knickschutz



Hellgrau RAL 7035  
Einteiliger Dichtring

Light grey RAL 7035  
One-piece sealing ring

G	$> \varnothing <$ min mm	$> \varnothing <$ max mm	mm	H mm	L mm	Art.-Nr.   Art. No.	
M12x1.5	2.5	6.5	15	54	6	1576.12.06	50
M16x1.5	4.0	8.0	19	64	6	1576.17.08	50
M20x1.5	3.0	7.0	24	88	8	1576.20.07	50
M20x1.5	5.5	12.0	24	88	8	1576.20.12	50



### SYNTEC mit Knickschutz



Dunkelgrau RAL 7001  
Einteiliger Dichtring

Dark grey RAL 7001  
One-piece sealing ring

G	$> \varnothing <$ min mm	$> \varnothing <$ max mm	mm	H mm	L mm	Art.-Nr.   Art. No.	
M12x1.5	2.5	6.5	15	54	6	1577.12.06	50
M16x1.5	4.0	8.0	19	64	6	1577.17.08	50
M20x1.5	3.0	7.0	24	88	8	1577.20.07	50
M20x1.5	5.5	12.0	24	88	8	1577.20.12	50



### SYNTEC mit Knickschutz



Schwarz RAL 9005  
Einteiliger Dichtring

Black RAL 9005  
One-piece sealing ring

G	$> \varnothing <$ min mm	$> \varnothing <$ max mm	mm	H mm	L mm	Art.-Nr.   Art. No.	
M12x1.5	2.5	6.5	15	54	6	1546.12.06	50
M16x1.5	4.0	8.0	19	64	6	1546.17.08	50
M20x1.5	3.0	7.0	24	88	8	1546.20.07	50
M20x1.5	5.5	12.0	24	88	8	1546.20.12	50



# Kabelverschraubungen Syntec® Kunststoff mit Lamellentechnik und Knickschutz

## Synthetic Syntec® cable glands with lamellar technology and anti-kink nozzle

Langes Anschlussgewinde metrisch | Long entry thread metric

Material: Polyamid PA 6  
 Eigenschaften: halogenfrei  
 Dichtring: CR (Neopren)  
 Einsatztemperatur: -30°C / +100°C  
 Schutzart: IP 68

Material: Polyamide PA 6  
 Properties: Halogen-free  
 Sealing ring: CR (neoprene)  
 Temperature range: -30°C / +100°C  
 Protection class: IP 68

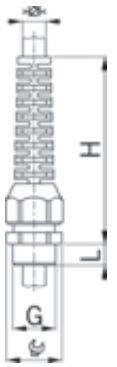

### SYNTEC mit Knickschutz



Hellgrau RAL 7035 Einteiliger Dichtring		Light grey RAL 7035 One-piece sealing ring					
G	> Ø < min mm	> Ø < max mm	 mm	H mm	L mm	Art.-Nr.   Art. No.	
M12x1.5	2.5	6.5	15	54	12	1576.12.1.06	50
M16x1.5	4.0	8.0	19	64	12	1576.17.1.08	50
M20x1.5	3.0	7.0	24	88	13	1576.20.1.07	50
M20x1.5	5.5	12.0	24	88	13	1576.20.1.12	50



### SYNTEC mit Knickschutz



Dunkelgrau RAL 7001 Einteiliger Dichtring		Dark grey RAL 7001 One-piece sealing ring					
G	> Ø < min mm	> Ø < max mm	 mm	H mm	L mm	Art.-Nr.   Art. No.	
M12x1.5	2.5	6.5	15	54	12	1577.12.1.06	50
M16x1.5	4.0	8.0	19	64	12	1577.17.1.08	50
M20x1.5	3.0	7.0	24	88	13	1577.20.1.07	50
M20x1.5	5.5	12.0	24	88	13	1577.20.1.12	50



### SYNTEC mit Knickschutz



Schwarz RAL 9005 Einteiliger Dichtring		Black RAL 9005 One-piece sealing ring					
G	> Ø < min mm	> Ø < max mm	 mm	H mm	L mm	Art.-Nr.   Art. No.	
M12x1.5	2.5	6.5	15	54	12	1546.12.1.06	50
M16x1.5	4.0	8.0	19	64	12	1546.17.1.08	50
M20x1.5	3.0	7.0	24	88	13	1546.20.1.07	50
M20x1.5	5.5	12.0	24	88	13	1546.20.1.12	50



1  
2  
3  
4  
5  
6  
7  
8  
9  
10  
11  
12

# Kabelverschraubungen Syntec® Kunststoff mit Lamellentechnik und Knickschutz Synthetic Syntec® cable glands with lamellar technology and anti-kink nozzle

## Anschlussgewinde Pg | Entry thread Pg

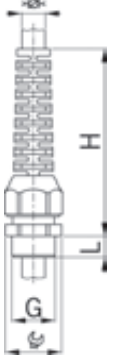

Material: Polyamid PA 6  
Eigenschaften: halogenfrei  
Dichtring: CR (Neopren)  
Einsatztemperatur: -30°C / +100°C  
Schutzart: IP 68

Material: Polyamide PA 6  
Properties: Halogen-free  
Sealing ring: CR (neoprene)  
Temperature range: -30°C / +100°C  
Protection class: IP 68



### SYNTEC mit Knickschutz

Hellgrau RAL 7035  
Einteiliger Dichtring

Light grey RAL 7035  
One-piece sealing ring



G	>Ø< min mm	>Ø< max mm	PG	H mm	L mm	Art.-Nr.   Art. No.	
Pg 7	2.5	6.5	15	54	8	1576.07.06	50
Pg 9	3.0	8.0	19	64	8	1576.09.08	50
Pg 11	2.0	7.0	22	77	8	1576.11.07	50
Pg 11	4.0	10.0	22	77	8	1576.11.10	50
Pg 13	3.0	7.0	24	88	9	1576.13.07	50
Pg 13	5.5	12.0	24	88	9	1576.13.12	50
Pg 16	5.0	11.0	27	102	10	1576.16.11	50
Pg 16	8.5	14.0	27	102	10	1576.16.14	50



### SYNTEC mit Knickschutz

Dunkelgrau RAL 7001  
Einteiliger Dichtring

Dark grey RAL 7001  
One-piece sealing ring



G	>Ø< min mm	>Ø< max mm	PG	H mm	L mm	Art.-Nr.   Art. No.	
Pg 7	2.5	6.5	15	54	8	1577.07.06	50
Pg 9	3.0	8.0	19	64	8	1577.09.08	50
Pg 11	2.0	7.0	22	77	8	1577.11.07	50
Pg 11	4.0	10.0	22	77	8	1577.11.10	50
Pg 13	3.0	7.0	24	88	9	1577.13.07	50
Pg 13	5.5	12.0	24	88	9	1577.13.12	50
Pg 16	5.0	11.0	27	102	10	1577.16.11	50
Pg 16	8.5	14.0	27	102	10	1577.16.14	50



### SYNTEC mit Knickschutz

Schwarz RAL 9005  
Einteiliger Dichtring

Black RAL 9005  
One-piece sealing ring



G	>Ø< min mm	>Ø< max mm	PG	H mm	L mm	Art.-Nr.   Art. No.	
Pg 7	2.5	6.5	15	54	8	1546.07.06	50
Pg 9	3.0	8.0	19	64	8	1546.09.08	50
Pg 11	2.0	7.0	22	77	8	1546.11.07	50
Pg 11	4.0	10.0	22	77	8	1546.11.10	50
Pg 13	3.0	7.0	24	88	9	1546.13.07	50
Pg 13	5.5	12.0	24	88	9	1546.13.12	50
Pg 16	5.0	11.0	27	102	10	1546.16.11	50
Pg 16	8.5	14.0	27	102	10	1546.16.14	50

# Kabelverschraubungen Syntec® Kunststoff mit Lamellentechnik und Knickschutz Synthetic Syntec® cable glands with lamellar technology and anti-kink nozzle

## Anschlussgewinde NPT | Entry thread NPT

Material: Polyamid PA 6  
Eigenschaften: halogenfrei  
Dichtring: CR (Neopren)  
Einsatztemperatur: -30°C / +100°C  
Schutzart: IP 54  
Weitere Schutzart: IP 68, wenn Anschlussgewinde abgedichtet

Material: Polyamide PA 6  
Properties: Halogen-free  
Sealing ring: CR (neoprene)  
Temperature range: -30°C / +100°C  
Protection class: IP 54  
Further protection: IP 68, if the entry thread is sealed

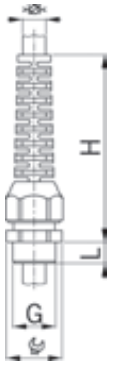

### SYNTEC mit Knickschutz



Hellgrau RAL 7035 Einteiliger Dichtring		Light grey RAL 7035 One-piece sealing ring				
G	> Ø < min mm	> Ø < max mm	H	L	Art.-Nr.   Art. No.	
			mm	mm		
NPT 3/8"	3.0	8.0	19/22	64	1576.N0375.08	50
NPT 1/2"	3.0	7.0	24	88	1576.N0500.07	50
NPT 1/2"	5.5	12.0	24	88	1576.N0500.12	50



### SYNTEC mit Knickschutz



Dunkelgrau RAL 7001 Einteiliger Dichtring		Dark grey RAL 7001 One-piece sealing ring				
G	> Ø < min mm	> Ø < max mm	H	L	Art.-Nr.   Art. No.	
			mm	mm		
NPT 3/8"	3.0	8.0	19/22	64	1577.N0375.08	50
NPT 1/2"	3.0	7.0	24	88	1577.N0500.07	50
NPT 1/2"	5.5	12.0	24	88	1577.N0500.12	50



### SYNTEC mit Knickschutz



Schwarz RAL 9005 Einteiliger Dichtring		Black RAL 9005 One-piece sealing ring				
G	> Ø < min mm	> Ø < max mm	H	L	Art.-Nr.   Art. No.	
			mm	mm		
NPT 3/8"	3.0	8.0	19/22	64	1546.N0375.08	50
NPT 1/2"	3.0	7.0	24	88	1546.N0500.07	50
NPT 1/2"	5.5	12.0	24	88	1546.N0500.12	50





# Flanschwinkel und Winkel

## Flanged elbows and elbows



Sind bei der Kabelinstallation enge Raumverhältnisse gegeben, kann der Anwender auf die Vorteile von **Winkeln und Flanschwinkeln** bauen. Hier werden Leitungen um die Ecke geführt und je nach der verwendeten Kabelverschraubung zu 100% vor der Knickstelle zugentlastet. Bei den Kunststoff-Flanschwinkeln erleichtert zudem ein spezieller Klappmechanismus die Kabelinstallation.

Die Quickseal Kabeleinführungstüllen sind spezielle Durchführungsmembranen und können auch als Verschlussstopfen verwendet werden. Zur Montage wird kein Werkzeug benötigt. Einfach Kabeldurchführung einstecken. Danach wird die geschlossene Membran durch Einstecken des durchzuführenden Kabels durchstoßen.

Die Würgenippel aus Kunststoff sind für den Einsatz in Installationsbereichen ohne besonderen Einsatz bestens geeignet. Erhältlich mit und ohne Bohrung.

If space is at a premium the user can take advantage of the benefits of **elbows and flanged elbows** for cable installations.

The cables are run around the bend and, depending upon the type of cable gland used, completely relieved of any strain before the kinking point.

A special folding mechanism simplifies the cable installation for synthetic flanged elbows.

Quickseal cable grommets are unique feedthrough membranes which can also be used as sealing caps. No tools are needed for assembly – simply insert the cable grommet. Afterwards, you take the cable to be fed through and push it through the closed membrane.

These locking plugs made of plastic are especially well suited for use in electrical installations and require no special effort to use. Available with and without pre-drilled holes.



Winkel-Kabelverschraubungen 90° Kunststoff Synthetic cable glands elbow 90°		<b>192</b>
Flanschwinkel 90° Kunststoff Synthetic flanged elbow 90°		<b>193</b>
Quickseal Kabeleinführungstüllen Quickseal cable grommets		<b>194</b>
Würgenippel Kunststoff Synthetic locking plug		<b>195</b>

- 1
- 2
- 3
- 4
- 5
- 6
- 7
- 8
- 9
- 10
- 11
- 12

# Winkel-Kabelverschraubungen 90° Kunststoff

## Synthetic cable glands elbow 90°

### Anschlussgewinde metrisch | Entry thread metric

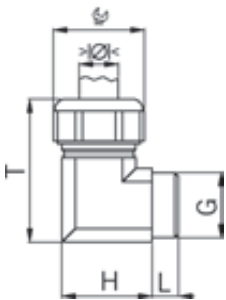

Material: Polyamid PA 6  
 Dichtung: TPE  
 Einsatztemperatur: -20°C / +100°C  
 Schutzart: IP 68

Material: Polyamide PA 6  
 Seal: TPE  
 Temperature range: -20°C / +100°C  
 Protection class: IP 68



Grau RAL 7032  
 Einteiliger Dichteinsatz

Grey RAL 7032  
 One-piece sealing insert

G	> Ø < min mm	> Ø < max mm	 mm	H mm	T mm	L mm	Art.-Nr.   Art. No.	
M16x1.5	6.5	9.5	19	23	38	8	5215.17.95	25
M20x1.5	7.0	10.5	24	28	46	9	5215.20.105	25
M20x1.5	9.0	13.0	24	28	46	9	5215.20.13	25
M25x1.5	11.5	15.5	27	32	52	10	5215.25.155	25



Schwarz RAL 9005  
 Einteiliger Dichteinsatz

Black RAL 9005  
 One-piece sealing insert



G	> Ø < min mm	> Ø < max mm	 mm	H mm	T mm	L mm	Art.-Nr.   Art. No.	
M16x1.5	6.5	9.5	19	23	38	8	5215.17.40.95	25
M20x1.5	7.0	10.5	24	28	46	9	5215.20.40.105	25
M20x1.5	9.0	13.0	24	28	46	9	5215.20.40.13	25
M25x1.5	11.5	15.5	27	32	52	10	5215.25.40.155	25

### Anschlussgewinde Pg | Entry thread Pg



Grau RAL 7032  
 Einteiliger Dichteinsatz

Grey RAL 7032  
 One-piece sealing insert

G	> Ø < min mm	> Ø < max mm	 mm	H mm	T mm	L mm	Art.-Nr.   Art. No.	
Pg 9	4.5	6.5	19	23	38	8	5215.09.65	25
Pg 9	6.5	9.5	19	23	38	8	5215.09.95	25
Pg 11	7.0	10.5	22	25	42	9	5215.11.105	25
Pg 11	4.0	6.5	22	25	42	9	5215.11.65	25
Pg 11	6.5	9.5	22	25	42	9	5215.11.95	25
Pg 13	7.0	10.5	24	28	46	9	5215.13.105	25
Pg 13	9.0	13.0	24	28	46	9	5215.13.13	25
Pg 13	6.5	9.5	24	32	46	9	5215.13.95	25
Pg 16	7.0	10.5	27	32	52	10	5215.16.105	25
Pg 16	9.0	13.0	27	32	52	10	5215.16.13	25
Pg 16	11.5	15.5	27	32	52	10	5215.16.155	25
Pg 16	6.5	9.5	27	32	52	10	5215.16.95	25

# Flanschwinkel 90° Kunststoff

## Synthetic flanged elbow 90°

### Anschlussgewinde metrisch | Entry thread metric

Material: Polyamid  
 Dichtung: NBR  
 Einsatztemperatur: -40°C / +110°C  
 Schutzart: IP 65  
 Eigenschaften: Der Flanschwinkel lässt sich zum Einführen der Kabel aufklappen und ermöglicht damit eine mühelose Montage

Material: Polyamide  
 Seal: NBR  
 Temperature range: -40°C / +110°C  
 Protection class: IP 65  
 Properties: The flanged elbow can be opened to insert the cables and therefore permits an effortless installation

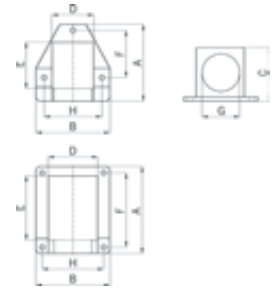

Grau		Grey							
G	A mm	B mm	C mm	D mm	E mm	F mm	H mm	Art.-Nr.   Art. No.	
M16x1.5	49	47	35	22	27	29	37	5500.20.17	10
M20x1.5	49	47	35	22	27	29	37	5500.20.20	10
M25x1.5	69	65	44	30	31	42	52	5500.20.25	10
M32x1.5	90	78	55	40	65	65	65	5500.20.32	10
M40x1.5	100	94	66	48	68	80	80	5500.20.40	5
M50x1.5	116	101	76	63	85	88	88	5500.20.50	5



Schwarz		Black							
G	A mm	B mm	C mm	D mm	E mm	F mm	H mm	Art.-Nr.   Art. No.	
M16x1.5	49	47	35	22	27	29	37	5500.40.17	10
M20x1.5	49	47	35	22	27	29	37	5500.40.20	10
M25x1.5	69	65	44	30	31	42	52	5500.40.25	10
M32x1.5	90	78	55	40	65	65	65	5500.40.32	10
M40x1.5	100	94	66	48	68	80	80	5500.40.40	5
M50x1.5	116	101	76	63	85	88	88	5500.40.50	5



### Anschlussgewinde Pg | Entry thread Pg

Grau		Grey							
G	A mm	B mm	C mm	D mm	E mm	F mm	H mm	Art.-Nr.   Art. No.	
Pg 11	49	47	35	22	27	29	37	5520.11	10
Pg 16	49	47	35	22	27	29	37	5520.16	10
Pg 21	69	65	44	30	31	42	52	5520.21	10
Pg 29	90	78	55	40	65	65	65	5520.29	10
Pg 36	100	94	66	48	68	80	80	5520.36	5
Pg 48	116	101	76	63	85	88	88	5520.48.48	5



Schwarz		Black							
G	A mm	B mm	C mm	D mm	E mm	F mm	H mm	Art.-Nr.   Art. No.	
Pg 11	49	47	35	22	27	29	37	5540.11	10
Pg 16	49	47	35	22	27	29	37	5540.16	10
Pg 21	69	65	44	30	31	42	52	5540.21	10
Pg 29	90	78	55	40	65	65	65	5540.29	10
Pg 36	100	94	66	48	68	80	80	5540.36	5
Pg 48	116	101	76	63	85	88	88	5540.48.48	5



# Quickseal Kabeleinführungstüllen

## Quickseal cable grommets

### Metrische Nenngößen | Metric rating

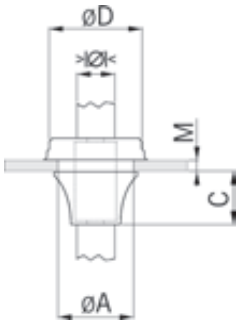

Material: EPDM  
 Einsatztemperatur: -40°C / +110°C  
 Schutzart: IP 67  
 Eigenschaften: Halogenfrei, allseitig IP 67 durch „Pushout-Membrane“, gute Chemikalien- und Witterungsbeständigkeit  
 Einsatzbereich: Universell einsetzbar bei Wandstärken von 1 bis 4 mm (M16 - M50) bzw. 0.5 bis 2 mm (M12)

Material: EPDM  
 Temperature range: -40°C / +110°C  
 Protection class: IP 67  
 Properties: Halogen-free, all-round IP 67 protection thanks to the “pushout-membrane”, resistant to chemicals and weatherproof  
 Application: Suitable for holes in materials of 1-4mm (M16 - M50), or M12 from 0.5-2mm



Dunkelgrau RAL 7001						Dark grey RAL 7001	
$\varnothing A$ mm	$>\varnothing<$ min mm	$>\varnothing<$ max mm	M mm	C mm	$\varnothing D$ mm	Art.-Nr.   Art. No.	
12.5	4.0	7.0	0.5-2	5.6	20.0	14.582.33	50
16.5	5.0	9.0	1-4	11.0	21.0	14.582.34	50
20.5	8.0	13.0	1-4	13.4	25.5	14.582.35	50
25.5	11.0	17.0	1-4	15.3	30.5	14.582.36	50
32.5	15.0	20.0	1-4	18.6	38.5	14.582.37	25
40.5	19.0	28.0	1-4	21.7	48.5	14.582.38	25
50.5	27.0	35.0	1-4	25.0	60.5	14.582.39	10



Hellgrau RAL 7035						Light grey RAL 7035	
$\varnothing A$ mm	$>\varnothing<$ min mm	$>\varnothing<$ max mm	M mm	C mm	$\varnothing D$ mm	Art.-Nr.   Art. No.	
12.5	4.0	7.0	0.5-2	5.6	20.0	14.583.03	50
16.5	5.0	9.0	1-4	11.0	21.0	14.583.04	50
20.5	8.0	13.0	1-4	13.4	25.5	14.583.05	50
25.5	11.0	17.0	1-4	15.3	30.5	14.583.06	50
32.5	15.0	20.0	1-4	18.6	38.5	14.583.07	25
40.5	19.0	28.0	1-4	21.7	48.5	14.583.08	25
50.5	27.0	35.0	1-4	25.0	60.5	14.583.09	10



Schwarz RAL 9005						Black RAL 9005	
$\varnothing A$ mm	$>\varnothing<$ min mm	$>\varnothing<$ max mm	M mm	C mm	$\varnothing D$ mm	Art.-Nr.   Art. No.	
12.5	4.0	7.0	0.5-2	5.6	20.0	14.582.93	50
16.5	5.0	9.0	1-4	11.0	21.0	14.582.94	50
20.5	8.0	13.0	1-4	13.4	25.5	14.582.95	50
25.5	11.0	17.0	1-4	15.3	30.5	14.582.96	50
32.5	15.0	20.0	1-4	18.6	38.5	14.582.97	25
40.5	19.0	28.0	1-4	21.7	48.5	14.582.98	25
50.5	27.0	35.0	1-4	25.0	60.5	14.582.99	10

## Anschlussgewinde metrisch | Entry thread metric

Material: Polyethylen  
Einsatztemperatur: -20°C / +70°C  
Schutzart: IP 54

Material: Polyethylene  
Temperature range: -20°C / +70°C  
Protection class: IP 54

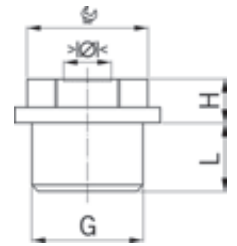

Hellgrau RAL 7035  
mit Bohrung

Light grey RAL 7035  
with bore hole

G	$\begin{matrix} > \varnothing < \\ \text{min mm} \end{matrix}$	$\begin{matrix} > \varnothing < \\ \text{max mm} \end{matrix}$	$\begin{matrix} \varnothing \\ \text{mm} \end{matrix}$	H mm	L mm	Art.-Nr.   Art. No.	
M16x1.5	5.0	10.8	15	7	10	1620.17	100
M20x1.5	8.0	13.5	19	8	12	1620.20	100
M25x1.5	9.0	16.0	24	10	12	1620.25	100
M32x1.5	11.0	22.0	30	11	14	1620.32	50
M40x1.5	17.0	24.0	37	12	16	1620.40	25
M50x1.5	22.0	35.0	46	13	18	1620.50	10
M63x1.5	24.0	43.0	56	15	20	1620.63	10



Hellgrau RAL 7035  
ohne Bohrung

Light grey RAL 7035  
without bore hole

G	$\begin{matrix} > \varnothing < \\ \text{min mm} \end{matrix}$	$\begin{matrix} > \varnothing < \\ \text{max mm} \end{matrix}$	$\begin{matrix} \varnothing \\ \text{mm} \end{matrix}$	H mm	L mm	Art.-Nr.   Art. No.	
M16x1.5	5.0	10.8	15	7	10	1600.17	100
M20x1.5	8.0	13.5	19	8	12	1600.20	100
M25x1.5	9.0	16.0	24	10	12	1600.25	100
M32x1.5	11.0	22.0	30	11	14	1600.32	100
M40x1.5	17.0	24.0	37	12	16	1600.40	25
M50x1.5	22.0	35.0	46	13	18	1600.50	10
M63x1.5	24.0	43.0	56	15	20	1600.63	10







Dank einer Reihe kleiner Helfer bei der Kabeleinführung lassen sich Produktionsanlagen problemlos an neue Aufgaben oder Gegebenheiten anpassen. Dabei kann nicht nur die Anzahl der Leitungen abweichen, sondern es können sich auch etliche Kabeldurchmesser ändern. Um hier den Arbeitsaufwand an Gehäusen und Schaltschränken zu minimieren, empfiehlt sich der Einsatz von Erweiterungen und Reduktionen. So können zum Beispiel einzelne Adern von dicken Kabeln durch eine Erweiterung in das Gehäuse eingeführt werden, wobei die äußere Leitungsisolierung in der Kabelverschraubung endet. Hierbei bleibt die vorhandene Schutzart selbstverständlich erhalten.

Überflüssige Gehäuseöffnungen werden durch den Einsatz von Verschlusschrauben abgedichtet und somit vor dem Eindringen von Schmutz bewahrt.











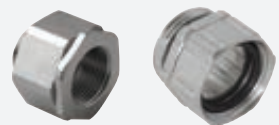

Falls keine Gewindebohrung vorhanden ist, können Gegenmuttern verwendet werden.

Thanks to a range of small accessories designed for the cable entry point, production systems can be easily adapted to take account of new tasks or new situations. Not only can the number of cables themselves change but cable diameters as well. To minimise the workload on housings and switchboard the use of extension or reduction fittings is recommended. An extension, for example, can be used to introduce the individual cores of thick cable into the housing with the outer cable insulation terminating in the cable gland. It goes without saying that the existing class of protection is maintained.

Redundant housing openings are sealed by locking screws to prevent the ingress of dirt.

If there is no tapped hole, locknuts can be used.



<p>Druckausgleichselemente Messing und Kunststoff Pressure balance elements nickel-plated brass and synthetics</p>	<p><b>NEW</b> </p> <p><b>198 - 200</b></p>	1
<p>Universal-Drehadapter und Richtungsfeststeller Messing Universal swivel adapter and adjustable fixing device nickel-plated brass</p>	<p></p> <p><b>201</b></p>	2
<p>Gegenmuttern Metall Metal lock nuts</p>	<p></p> <p><b>202 - 204</b></p>	3
<p>Gegenmuttern Kunststoff Synthetic lock nuts</p>	<p></p> <p><b>205 - 206</b></p>	4
<p>Reduktionen und Erweiterungen Messing Reduction and enlarging fittings nickel-plated brass</p>	<p></p> <p><b>207 - 215</b></p>	5
<p>Reduktionen und Erweiterungen Kunststoff Synthetic reduction and enlarging fittings</p>	<p></p> <p><b>216 - 219</b></p>	6
<p>Verschlusschrauben Metall und Kunststoff Locking plugs metal and synthetic</p>	<p></p> <p><b>220 - 224</b></p>	7
<p>Dichteinsätze Vollgummi Solid rubber sealing inserts</p>	<p></p> <p><b>225</b></p>	8
<p>O-Ringe und Dichtungsscheiben O-rings and sealing washers</p>	<p></p> <p><b>226 - 228</b></p>	9
<p>Blindscheiben, Verschlussbolzen, Einschnittringe Blind discs, locking pins, sealing rings</p>	<p></p> <p><b>228 - 229</b></p>	10
<p>Spezialwerkzeug Special tool</p>	<p></p> <p><b>230</b></p>	11
<p>MontaX® Montageplatte, Montagewinkel und Magnet MontaX® mounting plate, mounting angle and magnet</p>	<p></p> <p><b>230</b></p>	11
<p>AGRO Geflechschläuche Kunststoff AGRO synthetic braided cable sleeving</p>	<p></p> <p><b>231 - 238</b></p>	12

# Druckausgleichselement Messing und Kunststoff

## Pressure balance element nickel-plated brass and synthetic

Anschlussgewinde metrisch | Entry thread metric

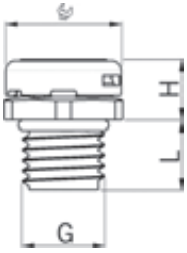

### Kunststoff Druckausgleichselement mit Membrane

Material: Polyamid PA 6  
 Membrane: PES Polyethersulfon  
 O-Ring : NBR  
 Einsatztemperatur: -40°C / +100°C  
 Schutzart: IP 66 / IP 68 / IP 69K  
 Wassereintrittsdruck: > 12.0 psi / 0.83 bar  
 Luftdurchsatz: > 90 ml / min / cm<sup>2</sup> bei 10 mbar  
 Eigenschaften: halogenfrei, UV beständig (getestet nach EN ISO 4892-2)

### Synthetic pressure balance element with membrane

Material: Polyamide PA 6  
 Membrane: PES polyethersulfone  
 O-ring : NBR  
 Temperature range: -40°C / +100°C  
 Protection class: IP 66 / IP 68 / IP 69K  
 Water intrusion pressure: > 12.0 psi / 0.83 bar  
 Air flow rate: > 90ml / min / cm<sup>2</sup> at 10 mbar  
 Properties: halogen-free, UV resistant (tested according to EN ISO 4892-2)



mit Membrane  
Schwarz

with membrane  
Black

G	H mm	L mm
M12x1.5	17	9 10

Art.-Nr. | Art. No.



2445.12

25

Auf Anfrage lieferbar:

Available on request:

Hellgrau RAL 7035

Light grey RAL 7035

# Druckausgleichselement Messing und Kunststoff

## Pressure balance element nickel-plated brass and synthetic

### Anschlussgewinde metrisch | Entry thread metric

#### Druckausgleichselement Messing mit Membrane

Material:	Messing vernickelt
Membrane:	PES Polyethersulfon
O-Ring :	NBR
Einsatztemperatur:	-40°C / +110°C
Schutzart:	IP 66 / IP 68 / IP 69K
Wassereintrittsdruck:	> 12.0 psi / 0.83 bar
Luftdurchsatz:	> 90 ml / min / cm <sup>2</sup> bei 10 mbar

#### Pressure balance element nickel-plated brass with membrane

Material:	Nickel-plated brass
Membrane:	PES polyethersulfone
O-ring :	NBR
Temperature range:	-40°C / +110°C
Protection class:	IP 66 / IP 68 / IP 69K
Water intrusion pressure:	> 12.0 psi / 0.83 bar
Air flow rate:	> 90ml / min / cm <sup>2</sup> at 10 mbar

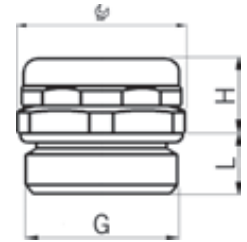

mit Membrane  
mit O-Ring

G	H mm	L mm	Art.-Nr.   Art. No.	
M12x1.5	18	9.5	2450.12.34	25
M16x1.5	18	9.5	2450.17.34	20
M20x1.5	22	10.0	2450.20.34	20

#### Auf Anfrage lieferbar:

Rostfreier Stahl A2 oder A4  
Für hohe Temperaturen (+200°C)

with membrane  
with O-ring

#### Available on request:

Stainless steel A2 or A4  
For high temperature applications (+200°C)



### Anschlussgewinde Pg | Entry thread Pg

mit Membrane  
mit O-Ring

G	H mm	L mm	Art.-Nr.   Art. No.	
Pg 7	18	9.5	2450.07.34	25
Pg 11	22	10.0	2450.11.34	20

#### Auf Anfrage lieferbar:

Rostfreier Stahl A2 oder A4  
Für hohe Temperaturen (+200°C)

with membrane  
with O-ring

#### Available on request:

Stainless steel A2 or A4  
For high temperature applications (+200°C)



### Anschlussgewinde metrisch | Entry thread metric

#### Druckausgleichselement Messing mit Sinterfilter

Material:	Messing vernickelt
Filterscheibe:	Sinterbronze
O-Ring :	NBR
Einsatztemperatur:	-50°C / +110°C
Schutzart:	IP 54 / IP x9K
Filtergrad:	40 µm

#### Pressure balance element nickel-plated brass with sintered filter

Material:	Nickel-plated brass
Filter disc:	Sintered bronze
O-ring :	NBR
Temperature range:	-50°C / +110°C
Protection class:	IP 54 / IP x9K
Degree of filter:	40 µm

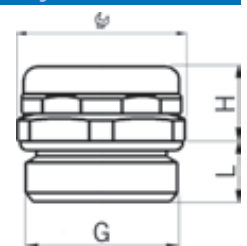

mit Sinterfilter  
mit O-Ring

G	H mm	L mm	Art.-Nr.   Art. No.	
M12x1.5	18	9.5	2450.12.32	25
M16x1.5	18	9.5	2450.17.32	20
M20x1.5	22	10.0	2450.20.32	20

#### Auf Anfrage lieferbar:

Rostfreier Stahl A2 oder A4  
Für hohe Temperaturen (+200°C)

Sintered filter  
with O-ring

#### Available on request:

Stainless steel A2 or A4  
For high temperature applications (+200°C)



# Druckausgleichselement Messing und Kunststoff

## Pressure balance element nickel-plated brass and synthetic

### Anschlussgewinde Pg | Entry thread Pg

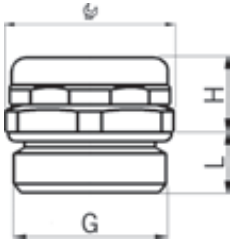

#### Druckausgleichselement Messing mit Sinterfilter

Material:	Messing vernickelt
Filterscheibe:	Sinterbronze
O-Ring :	NBR
Einsatztemperatur:	-50°C / +110°C
Schutzart:	IP 54 / IP x9K
Filtergrad:	40 µm



#### Pressure balance element nickel-plated brass with sintered filter

Material:	Nickel-plated brass
Filter disc:	Sintered bronze
O-ring :	NBR
Temperature range:	-50°C / +110°C
Protection class:	IP 54 / IP x9K
Degree of filter:	40 µm



mit Sinterfilter  
mit O-Ring

Sintered filter  
with O-ring

G	 mm	H mm	L mm	Art.-Nr.   Art. No.	
Pg 7	18	9.5	8	2450.07.32	25
Pg 11	22	10.0	8	2450.11.32	20

#### Auf Anfrage lieferbar:

Rostfreier Stahl A2 oder A4  
Für hohe Temperaturen (+200°C)

#### Available on request:

Stainless steel A2 or A4  
For high temperature applications (+200°C)

### Anschlussgewinde metrisch | Entry thread metric

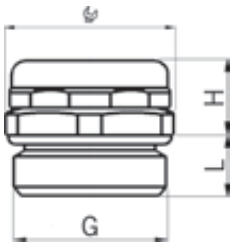

#### Entwässerungselement mit Sieb

Material:	Messing vernickelt
Sieb:	Rostfreier Stahl A2
O-Ring :	NBR
Einsatztemperatur:	-50°C / +110°C
Schutzart:	IP 4x



#### Drainage element with mesh

Material:	Nickel-plated brass
Mesh:	Stainless steel A2
O-ring :	NBR
Temperature range:	-50°C / +110°C
Protection class:	IP 4x



mit Sieb  
mit O-Ring

with mesh  
with O-ring

G	 mm	H mm	L mm	Art.-Nr.   Art. No.	
M12x1.5	18	9.5	10	2450.12.36	25
M16x1.5	18	9.5	10	2450.17.36	20
M20x1.5	22	10.0	10	2450.20.36	20

#### Auf Anfrage lieferbar:

Rostfreier Stahl A2 oder A4

#### Available on request:

Stainless steel A2 or A4

### Anschlussgewinde metrisch | Entry thread metric

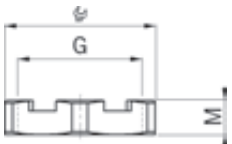

#### Gegenmutter zu Entwässerungselement

Material:	Messing vernickelt
Einsatztemperatur:	-50°C / +200°C

#### Lock nut for drainage element

Material:	Nickel-plated brass
Temperature range:	-50°C / +200°C



zum Entwässerungselement

for drainage element

G	 mm	M mm	Art.-Nr.   Art. No.	
M12x1.5	15	4.5	8324.12	25
M16x1.5	19	5.5	8324.17	20
M20x1.5	24	5.5	8324.20	20

# Richtungsfeststeller Messing

## Adjustable fixing devices nickel-plated brass

### Kurzes Anschlussgewinde metrisch | Short entry thread metric

#### AGRO Universal-Drehadapter Messing

Material: Messing vernickelt  
 Dichtringe: NBR  
 Einsatztemperatur: -40°C / +100°C  
 Schutzart: IP 68  
 Eigenschaften: Universell verwendbar mit Kabel- oder Schlauchverschraubungen, gute Drehfreudigkeit durch spezielle Lagerung

#### AGRO universal swivel adapter nickel-plated brass

Material: Nickel-plated brass  
 Sealing rings: NBR  
 Temperature range: -40°C / +100°C  
 Protection class: IP 68  
 Properties: Multifunctional use in combination with cable- or conduit glands, smooth rotation due to a special bearing

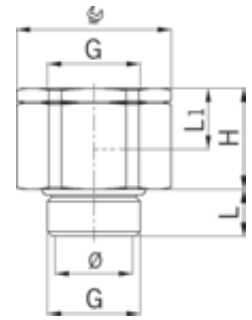

G		H mm	L mm	L1 mm	Ø mm	Art.-Nr.   Art. No.	
M16x1.5	24	20	10	12	11.0	2410.17	25
M20x1.5	30	22	10	13	15.5	2410.20	25
M25x1.5	36	24	11	13	20.5	2410.25	25
M32x1.5	46	27	13	14	28.0	2410.32	10
M40x1.5	55	28	13	15	37.0	2410.40	10
M50x1.5	65	32	14	16.5	43.0	2410.50	5

Achtung! Der Universal-Drehadapter kann kein Kugel- oder Wälzlager ersetzen! Attention! The swivel adapter can not replace rolling- or ball bearings!

### Anschlussgewinde metrisch | Entry thread metric

Material: Messing vernickelt  
 O-Ring : 2 x NBR  
 Einsatztemperatur: -30°C / +100°C  
 Schutzart: IP 68  
 Einsatzbereich: Besonders geeignet für die richtungsstabile Montage von Winkeln

Material: Nickel-plated brass  
 O-ring : 2 x NBR  
 Temperature range: -30°C / +100°C  
 Protection class: IP 68  
 Application: Suitable for directionally stable mounting of elbows

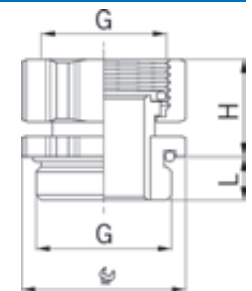

G		H mm	L mm	Art.-Nr.   Art. No.	
M16x1.5	18	14	6	5000.17.50	50
M20x1.5	22	14	6	5000.20.50	50
M25x1.5	28	15	7	5000.25.50	50
M32x1.5	35	18	8	5000.32.50	50

### Anschlussgewinde Pg | Entry thread Pg

G		H mm	L mm	Art.-Nr.   Art. No.	
Pg 9	17	14	6	5009.50	50
Pg 11	20	14	6	5011.50	50
Pg 13	22	14	6	5013.50	50
Pg 16	24	16	6	5016.50	50
Pg 21	30	18	7	5021.50	25
Pg 29	40	19	8	5029.50	25





# Gegenmuttern Messing

## Lock nuts nickel-plated brass

### Anschlussgewinde metrisch | Entry thread metric

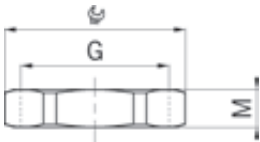

Material: Messing vernickelt  
 Ausführung: 6-kant  
 Einsatztemperatur: -40°C / +200°C

Material: Nickel-plated brass  
 Execution: Hexagonal design  
 Temperature range: -40°C / +200°C



Gewinde metrisch				Metric thread	
G	mm	M mm	i info	Art.-Nr.   Art. No.	
M6x0.75	9	2.8	-	8000.06.1	50
M6x1.0	9	2.8	1	8000.06	50
M8x1.0	11	2.8	-	8000.08.1	50
M8x1.25	11	2.8	1	8000.08	50
M10x1.0	13	2.8	-	8000.10.1	50
M10x1.5	13	2.8	1	8000.10	50
M12x1.5	15	3.0	-	8000.12	100
M16x1.5	19	3.0	-	8000.17	100
M20x1.5	24	3.5	-	8000.20	100
M25x1.5	30	4.0	-	8000.25	50
M32x1.5	36	4.0	-	8000.32	25
M40x1.5	46	5.0	-	8000.40	25
M50x1.5	55	5.5	-	8000.50	10
M63x1.5	70	6.0	-	8000.63	10
M75x1.5	80	6.0	-	8000.75	10
M80x2.0	95	8	-	8000.080	5
M85x2.0	95	8.0	-	8000.085	5
M95x2.0	110	9.0	-	8000.095	5
M100x3.0	115	9.0	-	8000.100	1
M105x3.0	120	9.0	-	8000.105	1
M115x3.0	125	10.0	-	8000.115	1

1 = Metrisches Regelgewinde 1 = Metric coarse-pitch thread

### Anschlussgewinde Pg | Entry thread Pg



Gewinde Pg			Pg thread	
G	mm	M mm	Art.-Nr.   Art. No.	
Pg 7	15	3.0	8007	50
Pg 9	18	3.0	8009	50
Pg 11	21	3.0	8011	50
Pg 13	23	3.0	8013	50
Pg 16	26	3.0	8016	50
Pg 21	32	3.5	8021	25
Pg 29	41	4.0	8029	10
Pg 36	51	5.0	8036	10
Pg 42	60	5.0	8042	10
Pg 48	64	5.5	8048.48	10

### Anschlussgewinde Gasrohr | Gas-pipe entry thread



Gasrohr-Gewinde				Gas-pipe thread	
G	mm	M mm	i info	Art.-Nr.   Art. No.	
G 3/8"	19	3.0	-	803/8G	10
G 1/2"	24	3.0	-	801/2G	10
G 5/8"	26	3.0	-	805/8G	10
G 3/4"	30	3.5	-	803/4G	10
G 1"	38	4.5	-	801G	10
G 1 1/2"	51	5.0	-	8011/2G	10
G 1 1/4"	46	5.0	-	8011/4G	10
G 2"	64	5.5	-	8048	10
G 2 1/2"	90	12.0	1	8050	50
G 3"	105	12.0	1	8051	50

1 = Runde Bauform, Stahl verzinkt 1 = Round form, zinc coated steel

### Anschlussgewinde metrisch | Entry thread metric

#### Gegenmuttern Messing, dicke Ausführung

#### Lock nuts nickel-plated brass, thick-walled version

Material: Messing vernickelt  
 Ausführung: 6-kant  
 Einsatztemperatur: -40°C / +200°C

Material: Nickel-plated brass  
 Execution: Hexagonal design  
 Temperature range: -40°C / +200°C

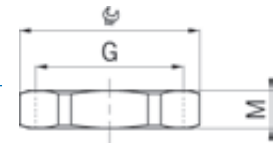

Dicke Ausführung			Thick-walled version		Art.-Nr.   Art. No.	
G		M mm				
M12x1.5	15	5.0			8300.12	50
M16x1.5	19	5.0			8300.17	50
M20x1.5	24	5.5			8300.20	50
M25x1.5	30	5.5			8300.25	50
M32x1.5	36	6.0			8300.32	50
M40x1.5	46	7.0			8300.40	50



### Anschlussgewinde Pg | Entry thread Pg

Dicke Ausführung			Thick-walled version		Art.-Nr.   Art. No.	
G		M mm				
Pg 7	15	5.0			8300.07	50
Pg 9	18	5.0			8300.09	50
Pg 11	21	5.0			8300.11	50
Pg 13	24	5.5			8300.13	50
Pg 16	26	5.5			8300.16	50
Pg 21	32	6.0			8300.21	50
Pg 29	41	7.0			8300.29	50



### Anschlussgewinde metrisch | Entry thread metric

#### Gegenmuttern Messing mit Hinterstich für O-Ring

#### Lock nuts nickel-plated brass with recess for O-ring

Material: Messing vernickelt  
 Ausführung: 6-kant  
 O-Ring : Separat bestellen  
 Einsatztemperatur: -40°C / +200°C

Material: Nickel-plated brass  
 Execution: Hexagonal design  
 O-ring : To be ordered separately  
 Temperature range: -40°C / +200°C

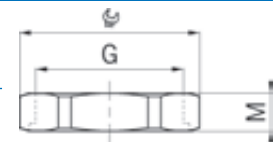

Dicke Ausführung ohne O-Ring				Thick-walled version without O-Ring		Art.-Nr.   Art. No.	
G		M mm	O-ring				
M12x1.5	15	5.0	1007.00.08			8300.12.1	50
M16x1.5	19	5.0	1016.00.15.08			8300.17.1	50
M20x1.5	24	5.5	1016.00.08			8300.20.1	50
M25x1.5	30	5.5	1013.00.22.08			8300.25.1	50
M32x1.5	36	6.0	1021.00.30.08			8300.32.1	50
M40x1.5	46	7.0	1029.00.39.08			8300.40.1	50
M50x1.5	55	7.5	1036.00.49.08			8300.50.1	10
M63x1.5	70	8.0	1048.00.62.08			8300.63.1	10



# Gegenmuttern rostfreier Stahl

## Stainless steel lock nuts

### Rostfreier Stahl A2 | Stainless steel A2

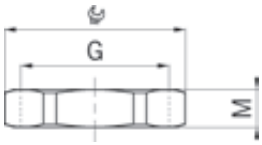

Material: Rostfreier CrNi-Stahl A2  
(DIN EN 1.4305 / AISI 303)

Ausführung: 6-kant

Einsatztemperatur: -40°C / +300°C

Material: CrNi stainless steel A2  
(DIN EN 1.4305 / AISI 303)

Execution: Hexagonal design

Temperature range: -40°C / +300°C



Gewinde metrisch				Metric thread		
G		M mm	i info	Art.-Nr.   Art. No.		
M8x1.25	11	2.8	1	8008.96	50	
M10x1.5	13	2.8	1	8010.96	50	
M12x1.5	17	3.0	-	8012.96	50	
M16x1.5	19	3.0	-	8017.96	50	
M20x1.5	24	3.5	-	8020.96	50	
M25x1.5	30	3.5	-	8025.96	25	
M32x1.5	36	4.5	-	8032.96	25	
M40x1.5	46	4.5	-	8040.96	10	
M50x1.5	55	5.5	-	8050.96	10	
M63x1.5	70	6.0	-	8063.96	5	

1 = Metrisches Regelgewinde      1 = Metric coarse-pitch thread



Gewinde Pg			Pg thread		
G		M mm	Art.-Nr.   Art. No.		
Pg 7	17	3.5	8007.96	50	
Pg 9	19	3.5	8009.96	50	
Pg 11	22	3.5	8011.96	50	
Pg 13	24	4.0	8013.96	50	
Pg 16	27	4.0	8016.96	50	
Pg 21	32	4.5	8021.96	25	
Pg 29	41	5.5	8029.96	10	
Pg 36	51	6.0	8036.96	10	

### Rostfreier und säurebeständiger Stahl A4 | Stainless steel and acid resistant A4

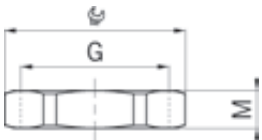

Material: Rostfreier- und säurebeständiger  
CrNiMo-Stahl A4  
(DIN EN 1.4435 / AISI 316L)

Ausführung: 6-kant

Einsatztemperatur: -40°C / +300°C

Material: Stainless and acid  
resistant steel A4 CrNiMo  
(DIN EN 1.4435 / AISI 316L)

Execution: Hexagonal design

Temperature range: -40°C / +300°C



Gewinde metrisch				Metric thread		
G		M mm	i info	Art.-Nr.   Art. No.		
M8x1.25	11	2.8	1	8008.98	50	
M10x1.5	13	2.8	1	8010.98	50	
M12x1.5	17	3.0	-	8012.98	50	
M16x1.5	19	3.0	-	8017.98	50	
M20x1.5	24	3.5	-	8020.98	50	
M25x1.5	30	3.5	-	8025.98	25	
M32x1.5	36	4.5	-	8032.98	25	
M40x1.5	46	4.5	-	8040.98	10	
M50x1.5	55	5.5	-	8050.98	10	
M63x1.5	70	6.0	-	8063.98	5	

1 = Metrisches Regelgewinde      1 = Metric coarse-pitch thread

### Anschlussgewinde metrisch | Entry thread metric

Material: Polyamid  
glasfaserverstärkt  
Ausführung: 6-kant  
Einsatztemperatur: -40°C / +100°C

Material: Polyamide glass fiber  
reinforced  
Execution: Hexagonal design  
Temperature range: -40°C / +100°C

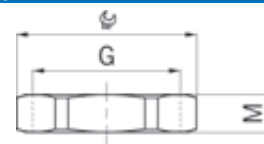

Hellgrau RAL 7035			Light grey RAL 7035		
G		M mm	Art.-Nr.   Art. No.		
M12x1.5	17	5.5	8212	100	
M16x1.5	22	5.5	8217	100	
M20x1.5	26	6.5	8220	100	
M25x1.5	32	7.0	8225	100	
M32x1.5	41	7.0	8232	100	
M40x1.5	50	7.0	8240	50	
M50x1.5	60	8.5	8250	10	



Schwarz RAL 9005			Black RAL 9005		
G		M mm	Art.-Nr.   Art. No.		
M12x1.5	17	5.5	8212.40	100	
M16x1.5	22	5.5	8217.40	100	
M20x1.5	26	6.5	8220.40	100	
M25x1.5	32	7.0	8225.40	100	
M32x1.5	41	7.0	8232.40	100	
M40x1.5	50	7.0	8240.40	50	
M50x1.5	60	8.5	8250.40	10	



### Anschlussgewinde Pg | Entry thread Pg

Hellgrau RAL 7035			Light grey RAL 7035		
G		M mm	Art.-Nr.   Art. No.		
Pg 7	19	5.0	8207	100	
Pg 9	22	6.0	8209	100	
Pg 11	24	6.0	8211	100	
Pg 13	27	6.0	8213	100	
Pg 16	30	6.0	8216	100	
Pg 21	36	7.0	8221	100	
Pg 29	46	7.0	8229	50	
Pg 36	60	8.0	8236	25	
Pg 42	65	8.0	8242	25	
Pg 48	70	8.0	8248.48	25	



Schwarz RAL 9005			Black RAL 9005		
G		M mm	Art.-Nr.   Art. No.		
Pg 7	19	5.0	8207.40	100	
Pg 9	22	6.0	8209.40	100	
Pg 11	24	6.0	8211.40	100	
Pg 13	27	6.0	8213.40	100	
Pg 16	30	6.0	8216.40	100	
Pg 21	36	7.0	8221.40	100	
Pg 29	46	7.0	8229.40	50	
Pg 36	60	8.0	8236.40	25	
Pg 42	65	8.0	8242.40	25	
Pg 48	70	8.0	8248.48.40	25	



# Gegenmuttern Kunststoff

## Synthetic lock nuts

### Anschlussgewinde metrisch | Entry thread metric

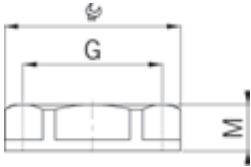

#### Gegenmuttern Kunststoff mit Flansch

Material: Polyamid PA 6  
 Eigenschaften: halogenfrei  
 Ausführung: 6-kant mit Flansch  
 Einsatztemperatur: -30°C / +100°C

#### Synthetic lock nuts with flange

Material: Polyamide PA 6  
 Properties: Halogen-free  
 Execution: Hexagonal design with flange  
 Temperature range: -30°C / +100°C



Hellgrau RAL 7035

G		M mm	Art.-Nr.   Art. No.	
M12x1.5	17	5.0	8255.12	100
M16x1.5	22	5.0	8255.17	100
M20x1.5	27	6.0	8255.20	100
M25x1.5	33	6.7	8255.25	100
M32x1.5	42	7.9	8255.32	50
M40x1.5	48	8.4	8255.40	50
M50x1.5	59	9.9	8255.50	10
M63x1.5	73	11.0	8255.63	10

Light grey RAL 7035



Schwarz RAL 9005

G		M mm	Art.-Nr.   Art. No.	
M12x1.5	17	5.0	8245.12	100
M16x1.5	22	5.0	8245.17	100
M20x1.5	27	6.0	8245.20	100
M25x1.5	33	6.7	8245.25	100
M32x1.5	42	7.9	8245.32	50
M40x1.5	48	8.4	8245.40	50
M50x1.5	59	9.9	8245.50	10
M63x1.5	73	11.0	8245.63	10

Black RAL 9005

### Anschlussgewinde Pg | Entry thread Pg



Hellgrau RAL 7035

G		M mm	Art.-Nr.   Art. No.	
Pg 7	19	5.0	8255.07	100
Pg 9	21	5.0	8255.09	100
Pg 11	24	5.0	8255.11	100
Pg 13	27	6.0	8255.13	100
Pg 16	30	6.0	8255.16	100
Pg 21	36	7.0	8255.21	50
Pg 29	46	8.0	8255.29	50
Pg 36	59	8.0	8255.36	25
Pg 42	65	8.0	8255.42	10
Pg 48	69	8.0	8255.48	10

Light grey RAL 7035



Schwarz RAL 9005

G		M mm	Art.-Nr.   Art. No.	
Pg 7	19	5.0	8245.07	100
Pg 9	21	5.0	8245.09	100
Pg 11	24	5.0	8245.11	100
Pg 13	27	6.0	8245.13	100
Pg 16	30	6.0	8245.16	100
Pg 21	36	7.0	8245.21	50
Pg 29	46	8.0	8245.29	50
Pg 36	59	8.0	8245.36	25
Pg 42	65	8.0	8245.42	10
Pg 48	69	8.0	8245.48	10

Black RAL 9005

# Reduktionen und Erweiterungen Messing

## Reduction and enlarging fittings nickel-plated brass

mit 6-kant | hexagonal

### Reduktionen Messing

Material: Messing vernickelt  
 O-Ring : NBR  
 Einsatztemperatur: -40°C / +100°C  
 Schutzart: IP 68

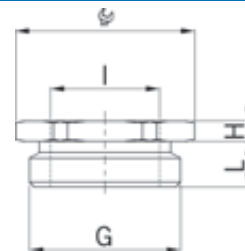

### Reduction fittings nickel-plated brass

Material: Nickel-plated brass  
 O-ring : NBR  
 Temperature range: -40°C / +100°C  
 Protection class: IP 68



Außengewinde metrisch  
 Innengewinde metrisch  
 mit O-Ring

Outer thread metric  
 Inner thread metric  
 with O-ring

G	I	 mm	H mm	L mm	i info	Art.-Nr.   Art. No.	
M 8x1.25	M 6x1.0	11	8.0	5	1	3500.08.06	50
M10x1.5	M 6x1.0	13	3.0	5	1	3500.10.06	50
M10x1.5	M 8x1.25	13	8.0	5	1	3500.10.08	50
M12x1.5	M 8x1.25	15	3.0	5	1	3500.12.08	50
M12x1.5	M10x1.5	15	8.0	5	1	3500.12.10	50
M16x1.5	M10x1.5	18	3.0	5	1	3500.17.10	50
M16x1.5	M12x1.5	18	3.0	5	-	3500.17.12	50
M20x1.5	M12x1.5	24	3.0	6	-	3500.20.12	50
M20x1.5	M16x1.5	24	3.0	6	-	3500.20.17	50
M25x1.5	M16x1.5	30	3.5	7	-	3500.25.17	25
M25x1.5	M20x1.5	30	3.5	7	-	3500.25.20	25
M32x1.5	M20x1.5	36	4.0	8	-	3500.32.20	20
M32x1.5	M25x1.5	36	4.0	8	-	3500.32.25	20
M40x1.5	M25x1.5	46	4.5	8	-	3500.40.25	10
M40x1.5	M32x1.5	46	4.5	8	-	3500.40.32	10
M50x1.5	M32x1.5	55	5.0	9	-	3500.50.32	10
M50x1.5	M40x1.5	55	5.0	9	-	3500.50.40	10
M63x1.5	M40x1.5	70	5.5	10	-	3500.63.40	5
M63x1.5	M50x1.5	70	5.5	10	-	3500.63.50	5
M75x1.5	M50x1.5	80	6.0	11	-	3500.75.50	5
M75x1.5	M63x1.5	80	6.0	11	-	3500.75.63	5

1 = Metrisches Regelgewinde

1 = Metric coarse-pitch thread

Runde Bauform, randriert | Round, knurled

### Reduktionen Messing

Material: Messing vernickelt  
 Einsatztemperatur: -40°C / +200°C  
 Schutzart: IP 54  
 Weitere Schutzart: IP 68, wenn Anschlussgewinde abgedichtet

### Reduction fittings nickel-plated brass

Material: Nickel-plated brass  
 Temperature range: -40°C / +200°C  
 Protection class: IP 54  
 Further protection: IP 68, if the entry thread is sealed

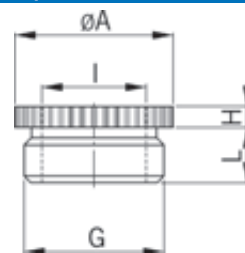

Außengewinde metrisch  
 Innengewinde metrisch  
 ohne O-Ring

Outer thread metric  
 Inner thread metric  
 without O-Ring

G	I	ØA mm	H mm	L mm	Art.-Nr.   Art. No.	
M16x1.5	M12x1.5	18	3	7	3545.17.12	100
M20x1.5	M12x1.5	22	3	8	3545.20.12	100
M20x1.5	M16x1.5	22	3	8	3545.20.17	100
M25x1.5	M16x1.5	27	3	8	3545.25.17	50
M25x1.5	M20x1.5	27	3	8	3545.25.20	50
M32x1.5	M20x1.5	34	4	9	3545.32.20	50
M32x1.5	M25x1.5	34	4	9	3545.32.25	50
M40x1.5	M25x1.5	42	4.5	9	3545.40.25	50
M40x1.5	M32x1.5	42	4.5	9	3545.40.32	25
M50x1.5	M32x1.5	52	4.5	10	3545.50.32	25
M50x1.5	M40x1.5	52	4.5	10	3545.50.40	10
M63x1.5	M40x1.5	65	5	11	3545.63.40	10
M63x1.5	M50x1.5	65	5	11	3545.63.50	10



# Reduktionen und Erweiterungen Messing

## Reduction and enlarging fittings nickel-plated brass

mit 6-kant | hexagonal

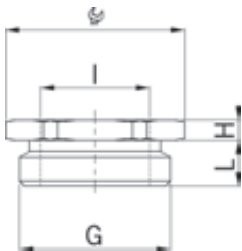

### Reduktionen Messing



Material: Messing vernickelt  
 O-Ring : NBR  
 Einsatztemperatur: -40°C / +100°C  
 Schutzart: IP 68

### Reduction fittings nickel-plated brass

Material: Nickel-plated brass  
 O-ring : NBR  
 Temperature range: -40°C / +100°C  
 Protection class: IP 68

Außengewinde Pg  
 Innengewinde Pg  
 mit O-Ring

Outer thread Pg  
 Inner thread Pg  
 with O-ring

G	I		H mm	L mm	Art.-Nr.   Art. No.	
Pg 9	Pg 7	18	3.0	6.5	3509.07	50
Pg 11	Pg 7	20	3.0	6.5	3511.07	50
Pg 11	Pg 9	22	3.0	7.0	3511.09	50
Pg 13	Pg 7	24	3.0	7.0	3513.07	50
Pg 13	Pg 9	24	3.0	7.0	3513.09	50
Pg 13	Pg 11	24	3.0	7.0	3513.11	50
Pg 16	Pg 9	24	3.0	7.0	3516.09	50
Pg 16	Pg 11	24	3.0	7.0	3516.11	50
Pg 16	Pg 13	27	3.0	7.0	3516.13	50
Pg 21	Pg 11	32	3.5	7.5	3521.11	25
Pg 21	Pg 13	32	3.5	7.5	3521.13	25
Pg 21	Pg 16	32	3.5	7.5	3521.16	25
Pg 29	Pg 13	38	4.0	8.0	3529.13	10
Pg 29	Pg 16	38	4.0	8.0	3529.16	10
Pg 29	Pg 21	38	4.0	8.0	3529.21	10
Pg 36	Pg 21	50	4.5	8.5	3536.21	10
Pg 36	Pg 29	50	4.5	8.5	3536.29	10
Pg 42	Pg 29	60	4.0	11.0	3542.29	10
Pg 42	Pg 36	60	4.0	11.0	3542.36	10
Pg 48	Pg 36	65	4.0	11.0	3548.48.36	10

# Reduktionen und Erweiterungen Messing

## Reduction and enlarging fittings nickel-plated brass

mit 6-kant | hexagonal

### Erweiterungen Messing

Material: Messing vernickelt  
 O-Ring : NBR  
 Einsatztemperatur: -40°C / +100°C  
 Schutzart: IP 68

### Enlarging fittings nickel-plated brass

Material: Nickel-plated brass  
 O-ring : NBR  
 Temperature range: -40°C / +100°C  
 Protection class: IP 68

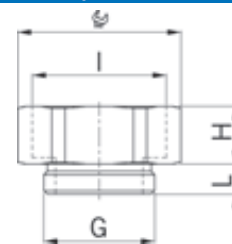

Außengewinde metrisch  
 Innengewinde metrisch  
 mit O-Ring

Outer thread metric  
 Inner thread metric  
 with O-ring

G	I		H mm	L mm	i info	Art.-Nr.   Art. No.	
M 6x1.0	M 8x1.25	11	8.5	5	1	3600.06.08	50
M 6x1.0	M10x1.5	13	8.5	5	1	3600.06.10	50
M 8x1.25	M10x1.5	13	9	5	1	3600.08.10	50
M 8x1.25	M12x1.5	15	9	5	1	3600.08.12	50
M10x1.5	M12x1.5	15	9	5	1	3600.10.12	50
M10x1.5	M16x1.5	18	9	5	1	3600.10.17	50
M12x1.5	M16x1.5	18	9	5	-	3600.12.17	50
M12x1.5	M20x1.5	24	10	5	-	3600.12.20	50
M16x1.5	M20x1.5	24	10	5	-	3600.17.20	50
M20x1.5	M25x1.5	30	11.5	6	-	3600.20.25	25
M25x1.5	M32x1.5	36	14	7	-	3600.25.32	25
M32x1.5	M40x1.5	46	14	8	-	3600.32.40	25
M40x1.5	M50x1.5	55	16	8	-	3600.40.50	10
M50x1.5	M63x1.5	70	17	9	-	3600.50.63	10
M63x1.5	M75x1.5	80	18	10	-	3600.63.75	10

1 = Metrisches Regelgewinde

1 = Metric coarse-pitch thread

Runde Bauform | Round execution

### Erweiterungen Messing

Material: Messing vernickelt  
 Einsatztemperatur: -40°C / +200°C  
 Schutzart: IP 54  
 Weitere Schutzart: IP 68, wenn Anschlussgewinde abgedichtet

### Enlarging fittings nickel-plated brass

Material: Nickel-plated brass  
 Temperature range: -40°C / +200°C  
 Protection class: IP 54  
 Further protection: IP 68, if the entry thread is sealed

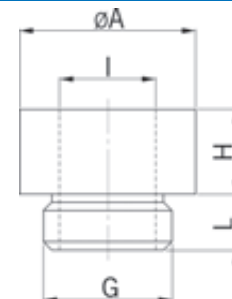

Außengewinde metrisch  
 Innengewinde metrisch  
 ohne O-Ring

Outer thread metric  
 Inner thread metric  
 without O-Ring

G	I	ØA mm	H mm	L mm	Art.-Nr.   Art. No.	
M12x1.5	M16x1.5	19	9.5	6.5	3645.12.17	100
M16x1.5	M20x1.5	22	10.5	7	3645.17.20	100
M20x1.5	M25x1.5	27	11	8	3645.20.25	100
M25x1.5	M32x1.5	34	12	8	3645.25.32	50
M32x1.5	M40x1.5	42	12	9	3645.32.40	50
M40x1.5	M50x1.5	53	14	9	3645.40.50	25
M50x1.5	M63x1.5	66	19	10	3645.50.63	25

1  
2  
3  
4  
5  
6  
7  
8  
9  
10  
11  
12

# Reduktionen und Erweiterungen Messing

## Reduction and enlarging fittings nickel-plated brass

mit 6-kant | hexagonal

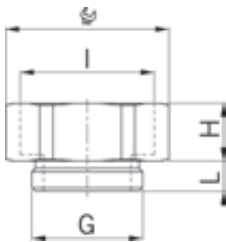

### Erweiterungen Messing



Material: Messing vernickelt  
 O-Ring : NBR  
 Einsatztemperatur: -40°C / +100°C  
 Schutzart: IP 68

### Enlarging fittings nickel-plated brass

Material: Nickel-plated brass  
 O-ring : NBR  
 Temperature range: -40°C / +100°C  
 Protection class: IP 68

Außengewinde Pg  
 Innengewinde Pg  
 mit O-Ring

Outer thread Pg  
 Inner thread Pg  
 with O-ring

<b>G</b>	<b>I</b>		<b>H</b> mm	<b>L</b> mm	<b>Art.-Nr.   Art. No.</b>	
<b>Pg 7</b>	Pg 9	18	13	8	<b>3607.09.08</b>	50
<b>Pg 9</b>	Pg 11	22	15	8	<b>3609.11.08</b>	50
<b>Pg 9</b>	Pg 13	24	15	8	<b>3609.13.08</b>	50
<b>Pg 11</b>	Pg 13	24	15	8	<b>3611.13.08</b>	50
<b>Pg 11</b>	Pg 16	24	15	8	<b>3611.16.08</b>	50
<b>Pg 11</b>	Pg 21	32	16	8	<b>3611.21.08</b>	50
<b>Pg 13</b>	Pg 16	24	15	8	<b>3613.16.08</b>	50
<b>Pg 13</b>	Pg 21	32	16	8	<b>3613.21.08</b>	50
<b>Pg 16</b>	Pg 21	32	16	8	<b>3616.21.08</b>	25
<b>Pg 16</b>	Pg 29	40	16	8	<b>3616.29.08</b>	25
<b>Pg 21</b>	Pg 29	40	16	8	<b>3621.29.08</b>	25
<b>Pg 29</b>	Pg 36	50	18	10	<b>3629.36.08</b>	20
<b>Pg 36</b>	Pg 42	60	19	12	<b>3636.42.08</b>	10
<b>Pg 36</b>	Pg 48	64	20	12	<b>3636.48.48.08</b>	10

mit 6-kant | hexagonal

Material: Messing vernickelt  
 O-Ring : NBR  
 Einsatztemperatur: -40°C / +100°C  
 Schutzart: IP 68

Material: Nickel-plated brass  
 O-ring : NBR  
 Temperature range: -40°C / +100°C  
 Protection class: IP 68

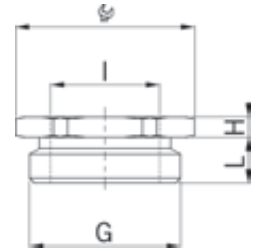

Außengewinde metrisch  
 Innengewinde Pg  
 mit O-Ring



Outer thread metric  
 Inner thread Pg  
 with O-ring

G	I		H mm	L mm	Art.-Nr.   Art. No.	
M16x1.5	Pg 7	20	3.0	7	3500.17.07	50
M20x1.5	Pg 7	24	3.0	7	3500.20.07	50
M20x1.5	Pg 9	24	3.0	7	3500.20.09	50
M20x1.5	Pg 11	24	10.0	7	3500.20.11	50
M25x1.5	Pg 9	30	3.5	8	3500.25.09	50
M25x1.5	Pg 11	30	3.5	8	3500.25.11	50
M25x1.5	Pg 13	30	3.8	8	3500.25.13	50
M25x1.5	Pg 16	30	15.0	8	3500.25.16	25
M32x1.5	Pg 21	38	16.0	8	3500.32.21	25
M40x1.5	Pg 29	45	16.0	8	3500.40.29	10
M50x1.5	Pg 29	55	4.0	10	3500.50.29	10
M63x1.5	Pg 36	70	5.5	11	3500.63.36	10



Außengewinde metrisch  
 Innengewinde Pg  
 mit O-Ring

Outer thread metric  
 Inner thread Pg  
 with O-ring

G	I		H mm	L mm	i info	Art.-Nr.   Art. No.	
M10x1.5	Pg 7	16	12	6	1	3600.10.07	50
M10x1.5	Pg 9	18	12	6	1	3600.10.09	50
M12x1.5	Pg 9	18	12	7	-	3600.12.09	50
M16x1.5	Pg 11	22	14	7	-	3600.17.11	50
M20x1.5	Pg 13	24	15	7	-	3600.20.13	50
M20x1.5	Pg 16	24	15	7	-	3600.20.16	50
M25x1.5	Pg 21	32	16	8	-	3600.25.21	25
M32x1.5	Pg 29	40	16	8	-	3600.32.29	25
M40x1.5	Pg 36	50	18	8	-	3600.40.36	20
M50x1.5	Pg 42	60	19	10	-	3600.50.42	10
M50x1.5	Pg 48	64	20	10	-	3600.50.48	10



1 = Metrisches Regelgewinde

1 = Metric coarse-pitch thread

# Adapter Messing

## Adapter nickel-plated brass

mit 6-kant | hexagonal

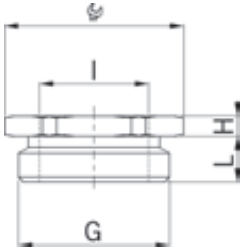



Material: Messing vernickelt  
 O-Ring : NBR  
 Einsatztemperatur: -40°C / +100°C  
 Schutzart: IP 68

Material: Nickel-plated brass  
 O-ring : NBR  
 Temperature range: -40°C / +100°C  
 Protection class: IP 68



Außengewinde Pg  
 Innengewinde metrisch  
 mit O-Ring

Outer thread Pg  
 Inner thread metric  
 with O-ring

G	I	 mm	H mm	L mm	i info	Art.-Nr.   Art. No.	
Pg 7	M 6x1.0	15	3.0	6	1	3500.07.06	50
Pg 7	M 8x1.25	15	3.0	6	1	3500.07.08	50
Pg 7	M10x1.5	15	7.0	6	1	3500.07.10	50
Pg 9	M 6x1.0	18	3.0	6	1	3500.09.06	50
Pg 9	M 8x1.25	18	3.0	6	1	3500.09.08	50
Pg 9	M10x1.5	18	3.0	6	1	3500.09.10	50
Pg 9	M12x1.5	18	8.0	6	-	3500.09.12	50
Pg 11	M 6x1.0	21	3.0	6	1	3500.11.06	50
Pg 11	M 8x1.25	21	3.0	6	1	3500.11.08	50
Pg 11	M10x1.5	21	3.0	6	1	3500.11.10	50
Pg 11	M12x1.5	21	3.0	6	-	3500.11.12	50
Pg 11	M16x1.5	21	8.0	6	-	3500.11.17	50
Pg 13	M12x1.5	24	3.0	6	-	3500.13.12	50
Pg 13	M16x1.5	24	3.0	6	-	3500.13.17	50
Pg 16	M12x1.5	24	3.0	6	-	3500.16.12	25
Pg 16	M16x1.5	24	3.0	6	-	3500.16.17	25
Pg 16	M20x1.5	24	10.5	6	-	3500.16.20	25
Pg 21	M16x1.5	30	3.5	7.5	-	3500.21.17	25
Pg 21	M20x1.5	30	3.5	7.5	-	3500.21.20	25
Pg 21	M25x1.5	30	10.5	7.5	-	3500.21.25	25
Pg 29	M25x1.5	38	4.0	8	-	3500.29.25	20
Pg 29	M32x1.5	38	13.0	8	-	3500.29.32	20
Pg 36	M32x1.5	50	4.5	8	-	3500.36.32	10
Pg 36	M40x1.5	50	4.5	8	-	3500.36.40	10
Pg 42	M32x1.5	55	5.0	10	-	3500.42.32	10
Pg 42	M40x1.5	55	5.0	10	-	3500.42.40	10
Pg 42	M50x1.5	55	15.0	10	-	3500.42.50	10
Pg 48	M40x1.5	65	5.5	11	-	3500.48.40	5
Pg 48	M50x1.5	65	5.5	11	-	3500.48.50	5

1 = Metrisches Regelgewinde

1 = Metric coarse-pitch thread

# Adapter Messing Adapter nickel-plated brass

mit 6-kant | hexagonal

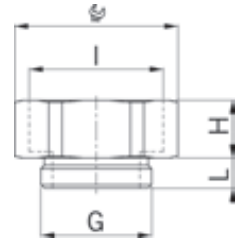

Material: Messing vernickelt  
O-Ring : NBR  
Einsatztemperatur: -40°C / +100°C  
Schutzart: IP 68

Material: Nickel-plated brass  
O-ring : NBR  
Temperature range: -40°C / +100°C  
Protection class: IP 68



Außengewinde Pg  
Innengewinde metrisch  
mit O-Ring

Outer thread Pg  
Inner thread metric  
with O-ring

G	I		H mm	L mm	Art.-Nr.   Art. No.	
Pg 7	M12x1.5	15	9.0	6	3600.07.12	50
Pg 7	M16x1.5	18	9.0	6	3600.07.17	50
Pg 9	M16x1.5	18	9.5	6	3600.09.17	50
Pg 9	M20x1.5	24	10.5	6	3600.09.20	50
Pg 11	M20x1.5	24	10.5	6	3600.11.20	50
Pg 11	M25x1.5	30	11.5	6	3600.11.25	25
Pg 13	M20x1.5	24	10.5	6	3600.13.20	50
Pg 13	M25x1.5	30	11.5	6	3600.13.25	25
Pg 16	M25x1.5	30	11.5	6	3600.16.25	25
Pg 16	M32x1.5	36	13.5	6	3600.16.32	25
Pg 21	M32x1.5	36	14.0	7.5	3600.21.32	25
Pg 21	M40x1.5	46	14.0	7.5	3600.21.40	20
Pg 29	M40x1.5	46	14.0	8	3600.29.40	20
Pg 29	M50x1.5	55	16.0	8	3600.29.50	10
Pg 36	M50x1.5	55	16.0	8	3600.36.50	10
Pg 36	M63x1.5	70	17.0	8	3600.36.63	10
Pg 42	M63x1.5	70	17.0	10	3600.42.63	10
Pg 42	M75x1.5	80	18.0	10	3600.42.75	10
Pg 48	M63x1.5	70	17.0	11	3600.48.63	10
Pg 48	M75x1.5	80	18.0	11	3600.48.75	10

Runde Bauform, randriert | Round, knurled

Material: Messing vernickelt  
Einsatztemperatur: -40°C / +200°C  
Schutzart: IP 54  
Weitere Schutzart: IP 68, wenn Anschlussgewinde abgedichtet

Material: Nickel-plated brass  
Temperature range: -40°C / +200°C  
Protection class: IP 54  
Further protection: IP 68, if the entry thread is sealed

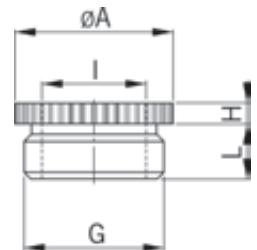

Außengewinde Pg  
Innengewinde metrisch  
ohne O-Ring

Outer thread Pg  
Inner thread metric  
without O-Ring

G	I	$\varnothing A$ mm	H mm	L mm	Art.-Nr.   Art. No.	
Pg 11	M16x1.5	20	10	6	3545.11.17	50
Pg 16	M20x1.5	24	11	6	3545.16.20	50
Pg 21	M20x1.5	30	3.5	7.5	3545.21.20	50
Pg 21	M25x1.5	30	11	7.5	3545.21.25	50
Pg 29	M25x1.5	39	4	8	3545.29.25	25
Pg 29	M32x1.5	39	4	8	3545.29.32	25
Pg 36	M40x1.5	50	4.5	8	3545.36.40	10



# Adapter Messing

## Adapter nickel-plated brass

### Runde Bauform | Round execution

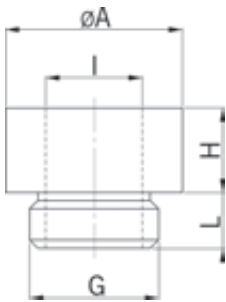

Material: Messing vernickelt  
 Einsatztemperatur: -40°C / +200°C  
 Schutzart: IP 54  
 Weitere Schutzart: IP 68, wenn Anschlussgewinde abgedichtet

Material: Nickel-plated brass  
 Temperature range: -40°C / +200°C  
 Protection class: IP 54  
 Further protection: IP 68, if the entry thread is sealed



Außengewinde Pg  
 Innengewinde metrisch  
 ohne O-Ring

Outer thread Pg  
 Inner thread metric  
 without O-Ring

G	I	øA mm	H mm	L mm	Art.-Nr.   Art. No.	
Pg 7	M12x1.5	14	9	6	3645.07.12	100
Pg 9	M16x1.5	19	9.5	6	3645.09.17	50
Pg 11	M20x1.5	22	11	6	3645.11.20	50
Pg 13	M20x1.5	22	11	6	3645.13.20	50
Pg 16	M25x1.5	27	11	6	3645.16.25	50
Pg 21	M32x1.5	34	12	7.5	3645.21.32	50
Pg 29	M40x1.5	42	12	8	3645.29.40	10

### mit 6-kant | hexagonal

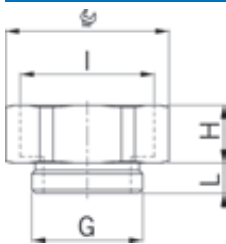

Material: Messing vernickelt  
 O-Ring : NBR  
 Einsatztemperatur: -40°C / +100°C  
 Schutzart: IP 68

Material: Nickel-plated brass  
 O-ring : NBR  
 Temperature range: -40°C / +100°C  
 Protection class: IP 68



Außengewinde Pg  
 Innengewinde Gasrohr  
 mit O-Ring

Outer thread Pg  
 Inner thread gas-pipe  
 with O-ring

G	I	 mm	H mm	L mm	Art.-Nr.   Art. No.	
Pg 13	G3/8"	24	3	7	35133/8G	50
Pg 16	G1/2"	24	14	10	36161/2G.08	50
Pg 21	G3/4"	32	14	12	36213/4G.08	25
Pg 36	G 2"	64	20	12	3636.48.08	10
Pg 42	G 2"	64	20	15	3642.48.08	10



Außengewinde Gasrohr  
 Innengewinde Pg  
 mit O-Ring

Outer thread gas-pipe  
 Inner thread Pg  
 with O-ring

G	I	 mm	H mm	L mm	Art.-Nr.   Art. No.	
G3/8"	Pg 7	20	3	10	353/8G.07	50
G1/2"	Pg 9	24	3	9.5	351/2G.09	50
G3/4"	Pg 9	30	3.5	11	353/4G.09	50
G3/4"	Pg 11	30	3.5	11	353/4G.11	50
G3/4"	Pg 16	32	3.5	11	353/4G.16	50
G 1"	Pg 21	38	3.5	11	351G.21	25
G 1 1/4"	Pg 29	50	5	11	3511/4G.29	25
G 2"	Pg 36	64	5	11	352G.36	10
G 2"	Pg 42	64	5	11	352G.42	10

# Adapter Messing Adapter nickel-plated brass

mit 6-kant | hexagonal

Material: Messing vernickelt  
O-Ring : NBR  
Einsatztemperatur: -40°C / +100°C  
Schutzart: IP 68

Material: Nickel-plated brass  
O-ring : NBR  
Temperature range: -40°C / +100°C  
Protection class: IP 68

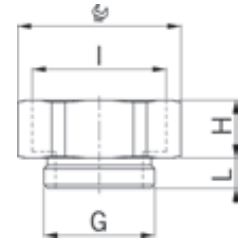

Außengewinde Gasrohr  
Gewinde innen Pg  
mit O-Ring

Outer thread gas-pipe  
Inner thread Pg  
with O-ring

G	I		H mm	L mm	Art.-Nr.   Art. No.	
G3/8"	Pg 11	20	12	10	363/8G.11.08	50
G1/2"	Pg 11	24	12	10	361/2G.11.08	50
G1/2"	Pg 13	24	12	10	361/2G.13.08	50
G1/2"	Pg 16	24	12	10	361/2G.16.08	50
G5/8"	Pg 16	24	12	10	365/8G.16.08	50
G3/4"	Pg 21	32	15	12	363/4G.21.08	25
G7/8"	Pg 29	41	15	12	367/8G.29.08	25
G 1"	Pg 29	41	15	11	361G.29.08	25
G 1 1/2"	Pg 36	54	22	12	3611/2G.36.08	10



mit 6-kant | hexagonal

Material: Messing vernickelt  
Einsatztemperatur: -40°C / +100°C  
Schutzart: IP 68, wenn Anschlussgewinde abgedichtet

Material: Nickel-plated brass  
Temperature range: -40°C / +100°C  
Protection class: IP 68, if the entry thread is sealed

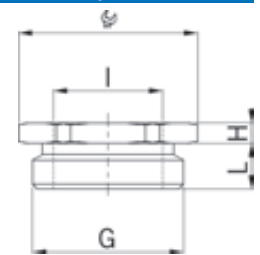

Außengewinde NPT  
Innengewinde Pg  
ohne O-Ring

Outer thread NPT  
Inner thread Pg  
without O-Ring

G	I		H mm	L mm	Art.-Nr.   Art. No.	
NPT1/2"	Pg 9	22	4.5	20	351/2NPT.09	50
NPT3/4"	Pg 11	30	4	20	353/4NPT.11	10
NPT3/4"	Pg 13	30	4	20	353/4NPT.13	10
NPT 1"	Pg 16	36	6	26	351NPT.16	10



mit 6-kant | hexagonal

Material: Messing vernickelt  
O-Ring : NBR  
Einsatztemperatur: -40°C / +100°C  
Schutzart: IP 68, wenn Anschlussgewinde abgedichtet

Material: Nickel-plated brass  
O-ring : NBR  
Temperature range: -40°C / +100°C  
Protection class: IP 68, if the entry thread is sealed

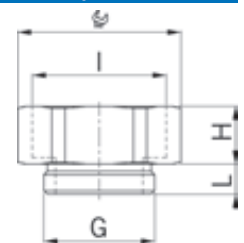

Außengewinde NPT  
Innengewinde Pg  
ohne O-Ring

Outer thread NPT  
Inner thread Pg  
without O-Ring

G	I		H mm	L mm	Art.-Nr.   Art. No.	
NPT1/2"	Pg 11	24	12	20	361/2NPT.11	50
NPT1/2"	Pg 13	24	14	20	361/2NPT.13	50
NPT1/2"	Pg 16	34	20	20	361/2NPT.16	50
NPT3/4"	Pg 21	32	14	20	363/4NPT.21	25



# Reduktionen und Erweiterungen Kunststoff

## Synthetic reduction and enlarging fittings

mit 6-kant | hexagonal

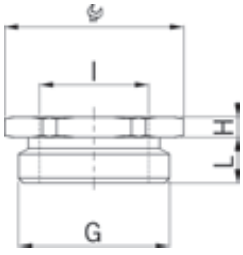

### Reduktionen Kunststoff

Material: Polyamid PA 6  
 Eigenschaften: halogenfrei  
 Einsatztemperatur: -30°C / +100°C  
 Schutzart: IP 54  
 Weitere Schutzart: IP 68, wenn Anschlussgewinde abgedichtet

### Synthetic reduction fittings

Material: Polyamide PA 6  
 Properties: Halogen-free  
 Temperature range: -30°C / +100°C  
 Protection class: IP 54  
 Further protection: IP 68, if the entry thread is sealed



Außengewinde metrisch  
 Innengewinde metrisch  
 Hellgrau RAL 7035

Outer thread metric  
 Inner thread metric  
 Light grey RAL 7035

G	I		H mm	L mm	Art.-Nr.   Art. No.	
M16x1.5	M12x1.5	22	4	8	3455.17.12	100
M20x1.5	M12x1.5	24	4	8	3455.20.12	100
M20x1.5	M16x1.5	24	4	8	3455.20.17	100
M25x1.5	M12x1.5	29	6	8	3455.25.12	100
M25x1.5	M16x1.5	29	6	8	3455.25.17	100
M25x1.5	M20x1.5	29	6	8	3455.25.20	100
M32x1.5	M12x1.5	36	6	10	3455.32.12	50
M32x1.5	M16x1.5	36	6	10	3455.32.17	50
M32x1.5	M20x1.5	36	6	10	3455.32.20	50
M32x1.5	M25x1.5	36	6	10	3455.32.25	50
M40x1.5	M16x1.5	46	6	10	3455.40.17	50
M40x1.5	M20x1.5	46	6	10	3455.40.20	50
M40x1.5	M25x1.5	46	6	10	3455.40.25	25
M40x1.5	M32x1.5	46	6	10	3455.40.32	25
M50x1.5	M20x1.5	55	6	12	3455.50.20	5
M50x1.5	M25x1.5	55	6	12	3455.50.25	5
M50x1.5	M32x1.5	55	6	12	3455.50.32	5
M50x1.5	M40x1.5	55	6	12	3455.50.40	5
M63x1.5	M25x1.5	68	6	12	3455.63.25	5
M63x1.5	M32x1.5	68	6	12	3455.63.32	5
M63x1.5	M40x1.5	68	6	12	3455.63.40	5
M63x1.5	M50x1.5	68	6	12	3455.63.50	5

mit 6-kant | hexagonal

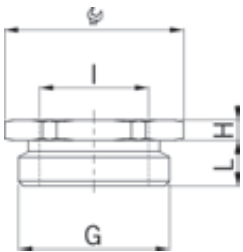

### Reduktionen Kunststoff

Material: Polyamid glasfaserverstärkt  
 Einsatztemperatur: -20°C / +100°C  
 Schutzart: IP 54  
 Weitere Schutzart: IP 68, wenn Anschlussgewinde abgedichtet

### Synthetic reduction fittings

Material: Polyamide glass fiber reinforced  
 Temperature range: -20°C / +100°C  
 Protection class: IP 54  
 Further protection: IP 68, if the entry thread is sealed



Außengewinde Pg  
 Innengewinde Pg  
 Hellgrau

Outer thread Pg  
 Inner thread Pg  
 Light grey

G	I		H mm	L mm	Art.-Nr.   Art. No.	
Pg 9	Pg 7	19	12	8	3409.07	50
Pg 11	Pg 7	22	3	8	3411.07	50
Pg 11	Pg 9	22	15	8	3411.09	50
Pg 13	Pg 9	24	3	9	3413.09	50
Pg 13	Pg 11	24	15	9	3413.11	50
Pg 16	Pg 9	27	5	9	3416.09	50
Pg 16	Pg 11	27	5	9	3416.11	50
Pg 16	Pg 13	27	17	10	3416.13	50
Pg 21	Pg 13	32	5	11	3421.13	25
Pg 21	Pg 16	32	5	11	3421.16	25
Pg 29	Pg 21	41	6	12	3429.21	10
Pg 36	Pg 29	50	6	14	3436.29	10

rund mit 6-kant | round with hexagon

### Erweiterungen Kunststoff

Material: Polyamid PA 6  
 Eigenschaften: halogenfrei  
 Einsatztemperatur: -30°C / +100°C  
 Schutzart: IP 54  
 Weitere Schutzart: IP 68, wenn Anschlussgewinde abgedichtet

### Synthetic enlarging fittings

Material: Polyamide PA 6  
 Properties: Halogen-free  
 Temperature range: -30°C / +100°C  
 Protection class: IP 54  
 Further protection: IP 68, if the entry thread is sealed

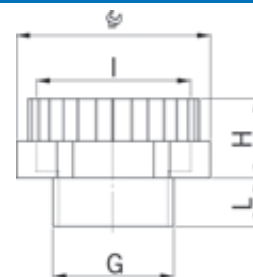

Außengewinde metrisch  
 Innengewinde metrisch  
 Hellgrau RAL 7035

Outer thread metric  
 Inner thread metric  
 Light grey RAL 7035

G	I		H mm	L mm	Art.-Nr.   Art. No.	
M12x1.5	M16x1.5	20	13	8	3755.12.17	100
M16x1.5	M20x1.5	24	13	8	3755.17.20	100
M20x1.5	M25x1.5	29	13	8	3755.20.25	100
M25x1.5	M32x1.5	36	15	8	3755.25.32	50
M32x1.5	M40x1.5	46	15	10	3755.32.40	25
M40x1.5	M50x1.5	55	15	10	3755.40.50	10
M50x1.5	M63x1.5	68	15	10	3755.50.63	10



rund mit 6-kant | round with hexagon

### Erweiterungen Kunststoff

Material: Polyamid glasfaserverstärkt  
 Einsatztemperatur: -20°C / +100°C  
 Schutzart: IP 54, IP 68 wenn Anschlussgewinde abgedichtet

### Synthetic enlarging fittings

Material: Polyamide glass fiber reinforced  
 Temperature range: -20°C / +100°C  
 Protection class: IP 54, IP 68 if the thread is sealed

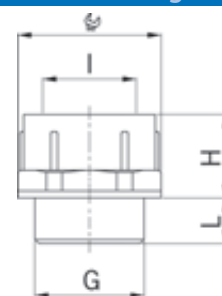

Außengewinde Pg  
 Innengewinde Pg  
 Hellgrau

Outer thread Pg  
 Inner thread Pg  
 Light grey

G	I		H mm	L mm	Art.-Nr.   Art. No.	
Pg 7	Pg 9	19	18	7	3707.09	50
Pg 9	Pg 11	22	19	7	3709.11	50
Pg 11	Pg 13	24	21	8	3711.13	50
Pg 13	Pg 16	27	23	9	3713.16	50
Pg 16	Pg 21	32	26	9	3716.21	25
Pg 21	Pg 29	41	33	10	3721.29	25
Pg 29	Pg 36	55	39	12	3729.36	10
Pg 36	Pg 42	60	46	14	3736.42	10
Pg 42	Pg 48	65	39	16	3742.48	10



# Adapter Kunststoff

## Synthetic adapter

### rund mit 6-kant | round with hexagon

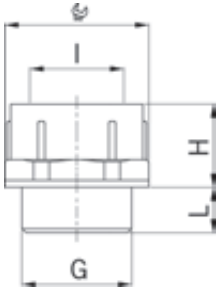

Material: Polyamid  
glasfaserverstärkt

Einsatztemperatur: -20°C / +100°C

Schutzart: IP 54

Weitere Schutzart: IP 68, wenn  
Anschlussgewinde  
abgedichtet

Material: Polyamide glass fiber  
reinforced

Temperature range: -20°C / +100°C

Protection class: IP 54

Further protection: IP 68, if  
the entry thread  
is sealed



Außengewinde metrisch  
Innengewinde Pg  
Hellgrau

Outer thread metric  
Inner thread Pg  
Light grey

<b>G</b>	<b>I</b>	<b>H</b> mm	<b>L</b> mm	<b>Art.-Nr.   Art. No.</b>	
<b>M12x1.5</b>	Pg 9	19	13	<b>3712.09</b>	50
<b>M20x1.5</b>	Pg 13	24	15	<b>3720.13</b>	50
<b>M20x1.5</b>	Pg 16	27	17	<b>3720.16</b>	50
<b>M25x1.5</b>	Pg 21	33	20	<b>3725.21</b>	25
<b>M32x1.5</b>	Pg 29	42	22	<b>3732.29</b>	25
<b>M50x1.5</b>	Pg 42	60	28	<b>3750.42</b>	10

### mit 6-kant | hexagonal



Außengewinde metrisch  
Gewinde innen Pg  
Hellgrau

Outer thread metric  
Inner thread Pg  
Light grey

<b>G</b>	<b>I</b>	<b>H</b> mm	<b>L</b> mm	<b>Art.-Nr.   Art. No.</b>	
<b>M16x1.5</b>	Pg 9	19	14	<b>3417.09</b>	50
<b>M20x1.5</b>	Pg 11	22	16	<b>3420.11</b>	50
<b>M25x1.5</b>	Pg 16	27	18	<b>3425.16</b>	50
<b>M40x1.5</b>	Pg 29	42	23	<b>3440.29</b>	25
<b>M50x1.5</b>	Pg 36	53	26	<b>3450.36</b>	10
<b>M63x1.5</b>	Pg 48	65	29	<b>3463.48</b>	5

rund mit 6-kant | round with hexagon

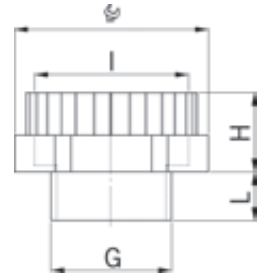

Material: Polyamid PA 6  
 Eigenschaften: halogenfrei  
 Einsatztemperatur: -30°C / +100°C  
 Schutzart: IP 54  
 Weitere Schutzart: IP 68, wenn Anschlussgewinde abgedichtet

Material: Polyamide PA 6  
 Properties: Halogen-free  
 Temperature range: -30°C / +100°C  
 Protection class: IP 54  
 Further protection: IP 68, if the entry thread is sealed



Außengewinde Pg Innengewinde metrisch Hellgrau RAL 7035				Outer thread Pg Inner thread metric Light grey RAL 7035		
G	I		H mm	L mm	Art.-Nr.   Art. No.	
Pg 7	M12x1.5	15	12	8	3755.07.12	100
Pg 7	M16x1.5	20	12	8	3755.07.17	100
Pg 9	M16x1.5	20	12	8	3755.09.17	100
Pg 9	M20x1.5	24	12	8	3755.09.20	100
Pg 11	M20x1.5	24	12	8	3755.11.20	100
Pg 13	M25x1.5	30	13	9	3755.13.25	100
Pg 16	M25x1.5	30	13	10	3755.16.25	50
Pg 21	M32x1.5	37	14	11	3755.21.32	50
Pg 29	M40x1.5	45	14	11	3755.29.40	50
Pg 42	M50x1.5	55	17	11	3755.42.50	10
Pg 48	M63x1.5	68	17	11	3755.48.63	5



Außengewinde Pg Innengewinde metrisch Hellgrau RAL 7035				Outer thread Pg Inner thread metric Light grey RAL 7035		
G	I		H mm	L mm	Art.-Nr.   Art. No.	
Pg 9	M12x1.5	19	12	8	3455.09.12	100
Pg 11	M16x1.5	22	12	8	3455.11.17	100
Pg 13	M16x1.5	24	13	9	3455.13.17	100
Pg 13	M20x1.5	24	13	9	3455.13.20	100
Pg 16	M20x1.5	27	13	10	3455.16.20	50
Pg 21	M25x1.5	33	14	11	3455.21.25	50
Pg 29	M32x1.5	42	14	11	3455.29.32	50
Pg 36	M40x1.5	55	14	11	3455.36.40	25



1  
2  
3  
4  
5  
6  
7  
8  
9  
10  
11  
12



# Verschlusschrauben Messing

## Locking plugs nickel-plated brass

### Kurzes Anschlussgewinde metrisch | Short entry thread metric

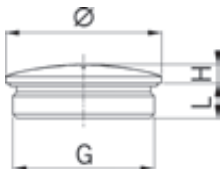

#### Verschlusschraube Messing

Material: Messing vernickelt  
 O-Ring : NBR  
 Einsatztemperatur: -40°C / +100°C  
 Schutzart: IP 68

#### Locking plug nickel-plated brass

Material: Nickel-plated brass  
 O-ring : NBR  
 Temperature range: -40°C / +100°C  
 Protection class: IP 68



Runde Bauform  
mit O-Ring

Round execution  
with O-ring

G	Ø mm	H mm	L mm	i info	Art.-Nr.   Art. No.	
M6x1.0	9	3	5	1	8706.08	50
M8x1.25	10	3	5	1	8708.08	50
M10x1.5	12	3	5	1	8710.08	50
M12x1.5	14	3	5	-	8712.08	50
M16x1.5	19	3	5	-	8717.08	50
M20x1.5	24	3	6	-	8720.08	25
M25x1.5	28	4	7	-	8725.08	25
M32x1.5	35	4	8	-	8732.08	10
M40x1.5	45	6	8	-	8740.08	10
M50x1.5	55	6	9	-	8750.08	10
M63x1.5	70	6	10	-	8763.08	10
M75x1.5	80	6	11	-	8775.08	5

1 = Metrisches Regelgewinde

1 = Metric coarse-pitch thread

### Langes Anschlussgewinde metrisch | Long entry thread metric



Runde Bauform  
mit O-Ring

Round execution  
with O-ring

G	Ø mm	H mm	L mm	i info	Art.-Nr.   Art. No.	
M6x1.0	9	3	8	1	8706.11.08	50
M8x1.25	10	3	10	1	8708.11.08	50
M10x1.5	12	3	10	1	8710.11.08	50
M12x1.5	14	3	10	-	8712.11.08	50
M16x1.5	19	3	10	-	8717.11.08	50
M20x1.5	24	3	10	-	8720.11.08	25
M25x1.5	28	4	11	-	8725.11.08	25
M32x1.5	35	4	13	-	8732.11.08	10
M40x1.5	45	6	13	-	8740.11.08	10
M50x1.5	55	6	14	-	8750.11.08	10
M63x1.5	70	6	15	-	8763.11.08	10
M75x1.5	80	6	15	-	8775.11.08	5

1 = Metrisches Regelgewinde

1 = Metric coarse-pitch thread



# Verschlusschrauben Messing

## Locking plugs nickel-plated brass

### Kurzes Anschlussgewinde metrisch | Short entry thread metric



#### Verschlusschraube Messing

Material: Messing vernickelt  
 Einsatztemperatur: -40°C / +200°C  
 Schutzart: IP 54  
 Weitere Schutzart: IP 68, wenn Anschlussgewinde abgedichtet

#### Locking plug nickel-plated brass

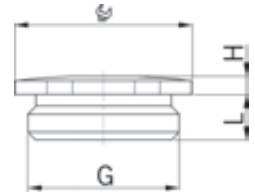
Material: Nickel-plated brass  
 Temperature range: -40°C / +200°C  
 Protection class: IP 54  
 Further protection: IP 68, if the entry thread is sealed



6-kant ohne O-Ring		Hexagonal design without O-Ring			
G		H mm	L mm	Art.-Nr.   Art. No.	
M12x1.5	14	2.5	5	8745.12	100
M16x1.5	18	2.5	5	8745.17	100
M20x1.5	22	2.5	6	8745.20	100
M25x1.5	27	3.0	7	8745.25	50
M32x1.5	34	3.5	8	8745.32	25
M40x1.5	42	4.0	8	8745.40	25
M50x1.5	52	4.0	9	8745.50	10
M63x1.5	65	4.0	10	8745.63	10



### Kurzes Anschlussgewinde Pg | Short entry thread Pg

#### Verschlusschraube Messing

Material: Messing vernickelt  
 O-Ring : NBR  
 Einsatztemperatur: -40°C / +100°C  
 Schutzart: IP 68

#### Locking plug nickel-plated brass

Material: Nickel-plated brass  
 O-ring : NBR  
 Temperature range: -40°C / +100°C  
 Protection class: IP 68

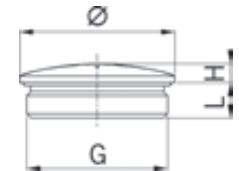

Runde Bauform mit O-Ring		Round execution with O-ring			
G	Ø mm	H mm	L mm	Art.-Nr.   Art. No.	
Pg 7	14	3	5	8707.08	100
Pg 9	17	3	6	8709.08	100
Pg 11	20	3	6	8711.08	100
Pg 13	22	3	6.5	8713.08	50
Pg 16	24	3	6.5	8716.08	50
Pg 21	30	4	7	8721.08	10
Pg 29	39	4	8	8729.08	10
Pg 36	50	6	9	8736.08	10
Pg 42	60	6	10	8742.08	10
Pg 48	65	6	10	8748.48.08	10
G 2"	65	6	10	8748.08	10



### Langes Anschlussgewinde Pg | Long entry thread Pg

Runde Bauform mit O-Ring		Round execution with O-ring			
G	Ø mm	H mm	L mm	Art.-Nr.   Art. No.	
Pg 7	14	3	10	8707.11.08	100
Pg 9	17	3	10	8709.11.08	100
Pg 11	20	3	10	8711.11.08	100
Pg 13	22	3	10	8713.11.08	50
Pg 16	24	3	10	8716.11.08	50
Pg 21	30	4	12	8721.11.08	10
Pg 29	39	4	12	8729.11.08	10
Pg 36	50	6	15	8736.11.08	10
G 2"	65	6	15	8748.11.08	10



# Verschlusschrauben rostfreier Stahl A2

## Locking plugs stainless steel A2

### Runde Bauform | Round execution

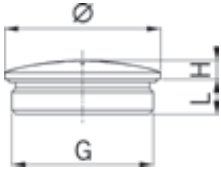

Material: Rostfreier CrNi-Stahl A2  
(DIN EN 1.4305 /  
AISI 303)

O-Ring : NBR

Einsatztemperatur: -40°C / +100°C

Schutzart: IP 68

Material: CrNi stainless steel  
A2 (DIN EN 1.4305 /  
AISI 303)

O-ring : NBR

Temperature range: -40°C / +100°C

Protection class: IP 68



Kurzes Anschlussgewinde metrisch  
mit O-Ring

Short entry thread metric  
with O-ring

G	Ø mm	H mm	L mm	i info	Art.-Nr.   Art. No.	
M10x1.5	12	3	5	1	8710.96.08.70	50
M12x1.5	14	3	5	-	8712.96.08.70	50
M16x1.5	19	3	5	-	8717.96.08.70	50
M20x1.5	24	3	6	-	8720.96.08.70	25
M25x1.5	28	4	7	-	8725.96.08.70	25
M32x1.5	35	4	8	-	8732.96.08.70	10
M40x1.5	45	6	8	-	8740.96.08.70	10
M50x1.5	55	6	9	-	8750.96.08.70	10
M63x1.5	70	6	10	-	8763.96.08.70	10
M75x1.5	80	6	11	-	8775.96.08.70	5

1 = Metrisches Regelgewinde

1 = Metric coarse-pitch thread

**Auf Anfrage lieferbar:**

**Available on request:**

Anschlussgewinde Pg

Entry thread Pg



Langes Anschlussgewinde metrisch  
mit O-Ring

Long entry thread metric  
with O-ring

G	Ø mm	H mm	L mm	i info	Art.-Nr.   Art. No.	
M10x1.5	12	3	10	1	8710.96.11.08.70	50
M12x1.5	14	3	10	-	8712.96.11.08.70	50
M16x1.5	19	3	10	-	8717.96.11.08.70	50
M20x1.5	24	3	10	-	8720.96.11.08.70	25
M25x1.5	28	4	11	-	8725.96.11.08.70	25
M32x1.5	35	4	13	-	8732.96.11.08.70	10
M40x1.5	45	6	13	-	8740.96.11.08.70	10
M50x1.5	55	6	14	-	8750.96.11.08.70	10
M63x1.5	70	6	15	-	8763.96.11.08.70	10
M75x1.5	80	6	15	-	8775.96.11.08.70	5

1 = Metrisches Regelgewinde

1 = Metric coarse-pitch thread

**Auf Anfrage lieferbar:**

**Available on request:**

Anschlussgewinde Pg

Entry thread Pg

### Verschlusschrauben rostfreier Stahl A2 für hohe Temperaturen

### Locking plugs stainless steel A2 for high temperature applications

Material: Rostfreier CrNi-Stahl A2 (DIN EN 1.4305 / AISI 303)  
 O-Ring : FPM  
 Einsatztemperatur: -40°C / +200°C  
 Schutzart: IP 68

Material: CrNi stainless steel A2 (DIN EN 1.4305 / AISI 303)  
 O-ring : FPM  
 Temperature range: -40°C / +200°C  
 Protection class: IP 68

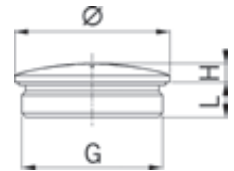

Kurzes Anschlussgewinde metrisch mit O-Ring

Short entry thread metric with O-ring

G	Ø mm	H mm	L mm	i info	Art.-Nr.   Art. No.	
M10x1.5	12	3	5	1	8710.96.08	50
M12x1.5	14	3	5	-	8712.96.08	50
M16x1.5	19	3	5	-	8717.96.08	50
M20x1.5	24	3	6	-	8720.96.08	25
M25x1.5	28	4	7	-	8725.96.08	25
M32x1.5	35	4	8	-	8732.96.08	10
M40x1.5	45	6	8	-	8740.96.08	10
M50x1.5	55	6	9	-	8750.96.08	10
M63x1.5	70	6	10	-	8763.96.08	10
M75x1.5	80	6	11	-	8775.96.08	5

1 = Metrisches Regelgewinde

1 = Metric coarse-pitch thread

**Auf Anfrage lieferbar:**

**Available on request:**

Anschlussgewinde Pg

Entry thread Pg



Langes Anschlussgewinde metrisch mit O-Ring

Long entry thread metric with O-ring

G	Ø mm	H mm	L mm	i info	Art.-Nr.   Art. No.	
M10x1.5	12	3	10	1	8710.96.11.08	50
M12x1.5	14	3	10	-	8712.96.11.08	50
M16x1.5	19	3	10	-	8717.96.11.08	50
M20x1.5	24	3	10	-	8720.96.11.08	25
M25x1.5	28	4	11	-	8725.96.11.08	25
M32x1.5	35	4	13	-	8732.96.11.08	10
M40x1.5	45	6	13	-	8740.96.11.08	10
M50x1.5	55	6	14	-	8750.96.11.08	10
M63x1.5	70	6	15	-	8763.96.11.08	10
M75x1.5	80	6	15	-	8775.96.11.08	5

1 = Metrisches Regelgewinde

1 = Metric coarse-pitch thread

**Auf Anfrage lieferbar:**

**Available on request:**

Anschlussgewinde Pg

Entry thread Pg



# Verschlusschrauben Kunststoff

## Synthetic locking plugs

### Gewinde metrisch | Metric thread

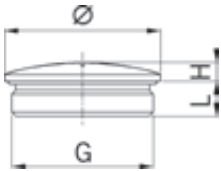

#### Verschlusschraube Kunststoff

Material: Polyamid PA 6  
 Einsatztemperatur: -30°C / +100°C  
 Schutzart: IP 54  
 Weitere Schutzart: IP 68, wenn Anschlussgewinde abgedichtet

#### Synthetic locking plug

Material: Polyamide PA 6  
 Temperature range: -30°C / +100°C  
 Protection class: IP 54  
 Further protection: IP 68, if the entry thread is sealed



Hellgrau RAL 7035  
 ohne O-Ring

Light grey RAL 7035  
 without O-Ring

G	Ø mm	H mm	L mm	Art.-Nr.   Art. No.	
M12x1.5	15	4.5	6	8855.12	100
M16x1.5	20	4.5	6	8855.17	100
M20x1.5	24	4.5	6	8855.20	100
M25x1.5	30	5.0	8	8855.25	100
M32x1.5	37	5.5	8	8855.32	50
M40x1.5	46	6.0	8	8855.40	50
M50x1.5	56	6.0	10	8855.50	10
M63x1.5	70	6.0	12	8855.63	10



Schwarz RAL 9005  
 ohne O-Ring

Black RAL 9005  
 without O-Ring

G	Ø mm	H mm	L mm	Art.-Nr.   Art. No.	
M12x1.5	15	4.5	6	8845.12	100
M16x1.5	20	4.5	6	8845.17	100
M20x1.5	24	4.5	6	8845.20	100
M25x1.5	30	5.0	8	8845.25	100
M32x1.5	37	5.5	8	8845.32	50
M40x1.5	46	6.0	8	8845.40	50
M50x1.5	56	6.0	10	8845.50	10
M63x1.5	70	6.0	12	8845.63	10

### Anschlussgewinde Pg | Entry thread Pg

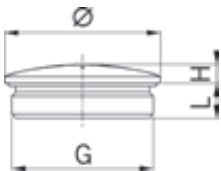

#### Verschlusschraube Kunststoff

Material: Polystyrol schlagfest  
 Einsatztemperatur: -20°C / +80°C  
 Schutzart: IP 54, IP 68 wenn Anschlussgewinde abgedichtet

#### Synthetic locking plug

Material: Shock-resistant polystyrene  
 Temperature range: -20°C / +80°C  
 Protection class: IP 54, IP 68 if the thread is sealed



Hellgrau RAL 7035  
 ohne O-Ring

Light grey RAL 7035  
 without O-Ring

G	Ø mm	H mm	L mm	Art.-Nr.   Art. No.	
Pg 7	15	2.0	6.0	8807	100
Pg 9	19	3.0	6.5	8809	100
Pg 11	22	3.5	6.5	8811	100
Pg 13	25	3.5	6.5	8813	100
Pg 16	27	3.5	6.5	8816	100
Pg 21	33	4.0	8.0	8821	100
Pg 29	44	4.0	8.0	8829	50
Pg 36	55	4.0	10.0	8836	25
Pg 42	62	4.0	10.0	8842	10
Pg 48	69	4.0	12.0	8848.48	25



passend zu Kabelverschraubungen Progress® | suitable for cable glands Progress®

Material: NBR  
Einsatztemperatur: -40°C / +100°C

Material: NBR  
Temperature range: -40°C / +100°C

Kurzer Dichteinsatz ohne Bohrung

Short sealing insert without drilled hole

G	 mm	Art.-Nr.   Art. No.	
M6	3.5	1000.06.30.03	1
M8	5.0	1000.08.30.03	1
M10	6.0	1000.10.30.03	1
Pg 11	12.0	1000.11.30.03	1
M12 / Pg 7	8.0	1000.12.30.03	1
M16 / Pg 9	10.5	1000.17.30.03	1
M20 / Pg 13 / Pg 16	15.0	1000.20.30.03	1
M25 / Pg 21	20.5	1000.25.30.03	1
Pg 29	27.5	1000.29.30.03	1
M32	25.5	1000.32.30.03	1
Pg 36	35.0	1000.36.30.03	1
M40	33.0	1000.40.30.03	1
Pg 48	49.0	1000.48.30.03	1
M50 / Pg 42	42.0	1000.50.30.03	1
M63	52.0	1000.63.30.03	1
M75	63.0	1000.75.30.03	1
M85	70.0	1000.085.30.03	1
M95	80.0	1000.095.30.03	1
M100	85.0	1000.100.30.03	1
M105	90.0	1000.105.30.03	1
M115	95.0	1000.115.30.03	1



### Technischer Hinweis

Dichteinsätze ohne Bohrung lassen sich gut bearbeiten, wenn sie vorher auf mindestens -25°C heruntergekühlt wurden.

### Technical note

When frozen to at least -25°C, the solid sealing inserts are easy to drill.

passend zu Kabelverschraubungen Progress® | suitable for cable glands Progress®

## Dichteinsätze Vollgummi für hohe Temperaturen

## Solid rubber sealing inserts for high-temperatures applications

Material: FPM  
Einsatztemperatur: -40°C / +200°C

Material: FPM  
Temperature range: -40°C / +200°C

Kurzer Dichteinsatz ohne Bohrung

Short sealing insert without drilled hole

G	 mm	Art.-Nr.   Art. No.	
M6	3.5	1000.06.98.30.03	1
M8	5.0	1000.08.98.30.03	1
M10	6.0	1000.10.98.30.03	1
Pg 11	12.0	1000.11.98.30.03	1
M12 / Pg 7	8.0	1000.12.98.30.03	1
M16 / Pg 9	10.5	1000.17.98.30.03	1
M20 / Pg 16	15.0	1000.20.98.30.03	1
M25 / Pg 21	20.5	1000.25.98.30.03	1
Pg 29	27.5	1000.29.98.30.03	1
M32	25.5	1000.32.98.30.03	1
Pg 36	35.0	1000.36.98.30.03	1
M40 / Pg 29	33.0	1000.40.98.30.03	1
Pg 48	49.0	1000.48.98.30.03	1
M50 / Pg 42	42.0	1000.50.98.30.03	1
M63	52.0	1000.63.98.30.03	1



### Technischer Hinweis

Dichteinsätze ohne Bohrung lassen sich gut bearbeiten, wenn sie vorher auf mindestens -25°C heruntergekühlt wurden.

### Technical note

When frozen to at least -25°C, the solid sealing inserts are easy to drill.



# O-Ringe und Dichtungsscheiben

## O-rings and sealing washers

passend zu Kabelverschraubungen Progress® | suitable for cable glands Progress®

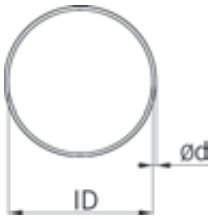

### O-Ringe

Material: NBR  
Einsatztemperatur: -40°C / +100°C

### O-rings

Material: NBR  
Temperature range: -40°C / +100°C



zu Anschlussgewinde metrisch oder Pg				suitable for entry thread metric or Pg	
G	G	øl mm	ød mm	Art.-Nr.   Art. No.	
M 6	-	5.0	1.0	1005.00.08	1
M 8	-	6.0	1.8	1006.00.08	1
M10	-	8.1	1.6	1006.06.08	1
M12	Pg 7	10.0	1.5	1007.00.08	1
M16	Pg 9	13.1	1.6	1000.09.00.08	1
M20	-	17.0	2.0	2111.00.08	1
M25	-	22.0	2.0	1013.00.22.08	1
M32	-	30.0	2.0	1021.00.30.08	1
M40	-	36.0	2.0	1000.40.00.08	1
M50	-	46.0	2.0	1000.50.00.08	1
M63	-	60.0	2.0	1000.63.00.08	1
M75	-	72.0	2.0	1000.75.00.08	1
-	Pg 11	15.0	2.0	1011.00.08	1
Pg 13	Pg 16	19.0	2.0	1016.00.08	1
-	Pg 21	25.0	2.0	1016.00.25.08	1
-	Pg 29	33.0	2.2	1029.00.08	1
-	Pg 36	42.5	2.6	1036.00.08	1
-	Pg 42	48.0	3.0	1000.42.00.08	1
-	Pg 48	55.0	2.0	1000.48.00.08	1

passend zu Kabelverschraubungen Progress® | suitable for cable glands Progress®

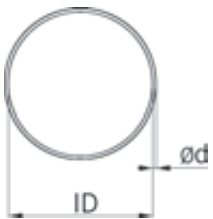

### O-Ringe für hohe Temperaturen

Material: FPM  
Einsatztemperatur: -40°C / +200°C

### O-rings for high temperatures

Material: FPM  
Temperature range: -40°C / +200°C



zu Anschlussgewinde metrisch oder Pg				suitable for entry thread metric or Pg	
G	G	øl mm	ød mm	Art.-Nr.   Art. No.	
M 6	-	5.0	1.0	1105.98.08	1
M 8	-	6.0	1.8	1106.98.08	1
M10	-	8.1	1.6	1106.06.98.08	1
M12	Pg 7	10.0	1.5	1107.98.08	1
M16	Pg 9	13.1	1.6	1100.09.98.08	1
M20	-	17.0	2.0	2111.98.08	1
M25	-	22.0	2.0	1113.98.22.08	1
M32	-	30.0	2.0	1121.98.30.08	1
M40	-	36.0	2.0	1100.40.98.08	1
M50	-	46.0	2.0	1100.50.98.08	1
M63	-	60.0	2.0	1100.63.98.08	1
M75	-	72.0	2.0	1100.75.98.08	1
-	Pg 11	15.0	2.0	1111.98.08	1
Pg 16	Pg 13	18.0	2.0	1116.98.08	1
-	Pg 21	25.0	2.0	1116.98.25.08	1
-	Pg 29	33.0	1.8	1129.98.08	1
-	Pg 36	42.5	2.6	1136.98.08	1
-	Pg 42	48.0	3.0	1100.42.98.08	1
-	Pg 48	55.0	2.0	1100.48.98.08	1

passend zu Kabelverschraubungen Progress® | suitable for cable glands Progress®

### Dichtungsscheiben

Material: KlingerSIL C-4300  
Einsatztemperatur: -40°C / +300°C  
Farbe: Grün

### Sealing washers

Material: KlingerSIL C-4300  
Temperature range: -40°C / +300°C  
Colour: Green

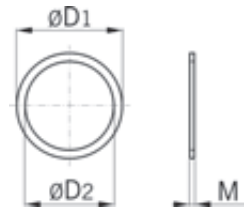

zu Anschlussgewinde metrisch

suitable for metric entry thread

G	ØD1 mm	ØD2 mm	M mm	Art.-Nr.   Art. No.	
M6	10.0	6.0	1.5	1006.00.16	1
M8	12.0	8.0	1.5	1008.00.16	1
M10	14.0	10.0	1.5	1010.00.16	1
M12	16.0	12.0	1.5	1012.00.16	1
M16	21.0	16.0	1.5	1017.00.16	1
M20 / Pg 13	25.0	20.5	1.5	1013.00.16	1
M25	31.0	25.0	2.0	1025.00.16	1
M32	39.0	32.0	2.0	1032.00.16	1
M40	48.0	40.0	2.0	1040.00.16	1
M50	59.0	50.0	2.0	1050.00.16	1
M63	73.0	63.0	2.0	1063.00.16	1



zu Anschlussgewinde Pg

suitable for entry thread Pg

G	ØD1 mm	ØD2 mm	M mm	Art.-Nr.   Art. No.	
Pg 7	16.5	12.5	1.5	1007.00.16	1
Pg 9	19.0	15.2	1.5	1009.00.16	1
Pg 11	22.5	18.5	1.5	1011.00.16	1
M20 / Pg 13	25.0	20.5	1.5	1013.00.16	1
Pg 16	27.0	22.5	1.5	1016.00.16	1
Pg 21	33.5	28.5	2.0	1021.00.16	1
Pg 29	43.5	37.0	2.0	1029.00.16	1
Pg 36	55.0	47.0	2.0	1036.00.16	1
Pg 42	63.0	54.0	2.0	1042.00.16	1
Pg 48	69.0	59.3	2.0	1048.00.16	1



1  
2  
3  
4  
5  
6  
7  
8  
9  
10  
11  
12

# O-Ringe und Dichtungsscheiben

## O-rings and sealing washers

passend zu Kabelverschraubungen Syntec® | suitable for cable glands Syntec®

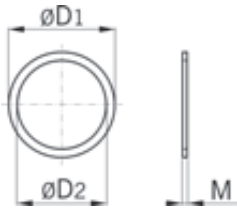

### Dichtungsscheiben

Material: Perbunan  
Einsatztemperatur: -20°C / +100°C

### Sealing washers

Material: Perbunan  
Temperature range: -20°C / +100°C



zu Anschlussgewinde metrisch

suitable for metric entry thread

G	ØD1 mm	ØD2 mm	M mm	Art.-Nr.   Art. No.	
M12	20	12	1.6	1012.45.16	50
M16	23	16	1.8	1017.45.16	50
M20	29	20	1.8	1020.45.16	50
M25	37	25	1.8	1025.45.16	50
M32	44	32	2.2	1032.45.16	25
M40	52	40	2.2	1040.45.16	25
M50	64	50	2.7	1050.45.16	25
M63	68	63	3.2	1063.45.16	10



zu Anschlussgewinde Pg

suitable for entry thread Pg

G	ØD1 mm	ØD2 mm	M mm	Art.-Nr.   Art. No.	
Pg 7	16.0	11.5	2.0	1007.45.16	50
Pg 9	19.0	14.0	2.0	1009.45.16	50
Pg 11	22.5	18.5	2.0	1011.45.16	50
Pg 13	25.0	19.0	2.0	1013.45.16	50
Pg 16	27.0	21.0	2.0	1016.45.16	50
Pg 21	34.0	27.0	2.5	1021.45.16	25
Pg 29	43.0	35.0	2.5	1029.45.16	25
Pg 36	54.0	45.0	2.5	1036.45.16	25

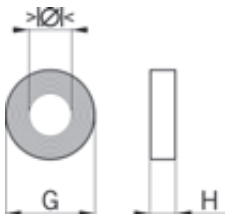

### Einschnittringe NBR passend zu Stopfbuchsen B 107- B 263

Material: NBR  
Einsatztemperatur: -20°C / +100°C  
Einsatzbereich: Passend zu Stopfbuchsen B107 - B263

### Sealing rings NBR suitable for cable gland B 107 - B 263

Material: NBR  
Temperature range: -20°C / +100°C  
Application: Suitable for cable glands series B107 - B263



G	G	>Ø< min mm	>Ø< max mm	H mm	Art.-Nr.   Art. No.	
M12	Pg 7	6.0	8.0	5.0	B 107.00.03	50
M16	Pg 9	4.0	11.0	5.5	B 109.00.03	50
-	Pg 11	6.5	12.0	6.0	B 111.00.03	50
-	Pg 13	6.5	13.5	6.0	B 113.00.03	50
M20	Pg 16	6.5	16.0	7.0	B 116.00.03	50
M25	Pg 21	9.0	20.0	8.0	B 121.00.03	50
M32	Pg 29	17.0	28.0	9.5	B 129.00.03	50
M40	Pg 36	23.0	34.0	12.0	B 136.00.03	50
M50	Pg 42	29.0	40.0	14.0	B 142.00.03	10
M63	Pg 48	35.0	46.0	14.0	B 148.00.03	10

### Blindscheiben passend zu Kabelverschraubungen

Material: Polyamid  
 Einsatztemperatur: -20°C / +100°C  
 Einsatzbereich: Staubverschluss zu Kabelverschraubungen

### Blind discs suitable for cable glands

Material: Polyamide  
 Temperature range: -20°C / +100°C  
 Application: Dust stopper for cable glands

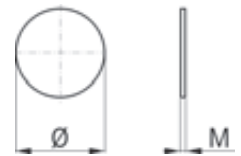

#### Blindscheibe als Staubschutz

#### Blind disc for dust protection

G	Ø mm	M mm	Art.-Nr.   Art. No.	
M10 / M12 / Pg 7	10.5	0.3	1012.00.19	50
M16 / Pg 9	13.5	0.3	1017.00.19	50
M20 / Pg 11	16.5	0.3	1011.00.19	50
Pg 13 / Pg 16	20.5	0.3	1020.00.19	50
M25 / Pg 21	26.5	0.3	1025.00.19	50
Pg 29	35.0	0.3	1029.00.19	50
M32	30.0	0.3	1032.00.19	50
Pg 36	45.0	0.3	1036.00.19	50
M40	38.0	0.3	1040.00.19	50
M50 / Pg 42	52.0	0.3	1050.00.19	50
M63 / Pg 48	57.0	0.3	1063.00.19	50



### Verschlussbolzen aus Kunststoff zu Mehrfach-Kabelverschraubungen

Material: Polyamid PA 6  
 Einsatztemperatur: -30°C / +100°C  
 Einsatzbereich: Zum Verschließen nicht belegter Bohrungen in Mehrfach-Kabelverschraubungen

### Synthetic locking pins for multi-duct cable glands

Material: Polyamide PA 6  
 Temperature range: -30°C / +100°C  
 Application: Usable as inserts to close unused holes in sealings of multi-duct cable glands

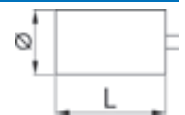

#### Verschlussbolzen zu Kabelverschraubungen

#### Locking pins for cable glands

>Ø< mm	L mm	Art.-Nr.   Art. No.	
2	12	1310.020.07	50
3	14	1310.030.07	50
4	14	1310.040.07	50
5	14	1310.050.07	50
6	14	1310.060.07	50
7	14	1310.070.07	50
8	14	1310.080.07	50
9	14	1310.090.07	50
10	14	1310.100.07	50
11	14	1310.110.07	50
12	14	1310.120.07	50



# Spezialwerkzeug, MontaX® Montageplatte, Montagewinkel, Magnet

## Special tool, MontaX® mounting plate, mounting angle, magnet

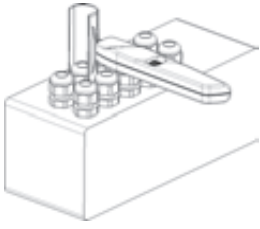

### Für Kabelverschraubungen | For cable glands



#### Spezialwerkzeug für Kabelverschraubungen | Special tool for cable glands

Einsatzbereich:	Montagewerkzeug für Kabelverschraubungen bei engsten Platzverhältnissen	Application:	Assembly tool for cable glands in restricted spaces
Eigenschaften:	Nur 2 Werkzeuge für Schlüsselweiten von 11 bis 36 mm notwendig, Zeitersparnis durch Ratschenfunktion	Properties:	Only 2 tools necessary for wrench sizes from 11 to 36 mm, time-saving due to the ratchet function



verstellbare Schlüsselweiten bei geringem Platzbedarf		adjustable wrench sizes for restricted spaces			
 1 mm	 2 mm	L mm	B mm	Art.-Nr.   Art. No.	
11	24	190	60	4800.24	1
24	36	204	60	4800.36	1

### Montageplatte, Montagewinkel, Magnet | mounting plate, mounting angle, magnet

#### Montageplatte

- über 200 Befestigungsmöglichkeiten für Geräte
- problemloses Anreihen zu größeren Flächen durch angespritzte Verbinder
- Montageplatte in zwei gleiche Hälften teilbar
- Befestigung an Kabelbahnen, Rund- oder Vierkantrohren, TS 35 Normprofilen usw.
- ortsveränderliche Montage durch Magnetbefestigung möglich



B mm	L mm	Art.-Nr.   Art. no.	
90	180	2000-00	1

#### Mounting plate

- over 200 fixing methods for accessories
- Injection-moulded connectors allow surfaces to be joined together effortlessly to form larger units
- Mounting plate can be split into two identical halves
- Attachment to cable ducts, round or square conduits, TS 35 standard profiles, etc.
- Magnet attached for adjustable mounting

#### Montagewinkel für MontaX®

- für 30°, 45°, 60° u. 90° Winkelstellung von MontaX® zur senkrechten Achse
- einfaches Ausrichten und Befestigen durch Schlüssellöcher mit Linsenkopfschrauben Ø 4,5 mm
- Befestigung der Montageplatte durch selbstformende Flachkopfschrauben Ø 3,9 mm in Einschraubnuten



Art.-Nr.   Art. no.	
2000-80	1

#### Mounting angle for MontaX®

- for 30°, 45°, 60° & 90° angular attachment of MontaX® to vertical axis
- simple straightening and attaching with 4.5 mm Ø raised head screws through keyholes
- mounting plate can be attached using self-tapping 3.9 mm Ø flat-head screws in mounting grooves

#### MontaX® - Magnet

- zur ortsveränderlichen Montage
- mit beigefügter Befestigungsschraube



Art.-Nr.   Art. no.	
2000-90	1

#### MontaX® - Magnet

- for adjustable mounting
- comes with fixing screw





In Zusammenarbeit mit namhaften Kunden haben wir die Produkteigenschaften erarbeitet, welche für den Anwender besonders wichtig sind und versucht, diese Kriterien zusammen mit Produktionstechnikern in verbesserte Produkte umzusetzen.

Die bemerkenswerteste Änderung ist der spitzere Flechtwinkel, in welchem die Einzelfäden miteinander verwoben sind. Diese neue Flechtweise kombiniert mit einem etwas dünneren Monofil bei der Ausführung in Polyester (0.22 mm im Gegensatz zu 0.25 mm des Vorgängerproduktes) führt zu einem extrem flexiblen Schlauch und zu einer hervorragenden Aufstauchbarkeit. Die Geflechte lassen sich auf das Doppelte ihrer Nennweite aufstauchen.

Der spitzere Flechtwinkel erlaubt ein geschmeidigeres Einführen von Leitungen und Kabeln auch über grössere Längen. Die Einzelfilamente laufen sozusagen parallel zu den Kabeln und stellen sich ihnen nicht als Hindernis oder „Einfädelstelle“ in den Weg.

Sowohl die Polyester- als auch die Polyamid-Geflechschläuche sind nach der neuesten Schienenfahrzeugnorm geprüft (EN 45545-2) und erreichen den Hazard Level 2.

In cooperation with renowned customers, we have defined the product properties which are especially important for the user and have tried together with production technicians to translate these criteria into improved products.

The most notable change is the more pointed braid angle in which the individual threads are interwoven. This new way of braiding, combined with a slightly thinner monofilament in the polyester version (0.22 mm as opposed to the 0.25 mm of the predecessor product) results in an extremely flexible tube and in outstanding tube-fitting qualities. The meshwork can be fitted on to areas twice as large as its nominal width.

The more pointed braid angle permits smoother insertion of cords and cables even across long distances. The individual filaments run virtually parallel to the cables and do not get in their way as an obstruction or "catching area".

Both the polyester and the polyamide braided sleeves have been tested in accordance with the latest rail vehicle standards (EN 45545-2) and can therefore be safely used in this application area.

1  
2  
3  
4  
5  
6  
7  
8  
9  
10  
11  
12



# AGRO Geflechschläuche Kunststoff

## AGRO synthetic braided cable sleeving

### AGROflex PET Geflechschläuche Polyester

Material:	Polyester PET
Monofil:	Ø 0,22mm
Eigenschaften:	Hochflexibel, selbstanpassend, abriebfest, frei von Cadmium, Formaldehyd, Halogen und Graphit, selbstverlöschend nach DIN 75200 (FMVSS 302), gute Beständigkeit gegen Kraftstoffe, Mineralöle und viele weitere Chemikalien
Einsatztemperatur:	-50°C / +150°C
Aufweitung:	Aufstauchverhältnis 1 : 2

### AGROflex PET Braided sleeveings polyester

Material:	Polyester PET
Monofil:	Ø 0,22mm
Properties:	Highly flexible, self-adapting, resistant to abrasion, free of cadmium, formaldehyde, halogen and graphite, self-extinguishing acc. to DIN 75200 (FMVSS 302), good resistance to fuel, mineral oil and many other chemicals
Temperature range:	-50°C / +150°C
Expansion:	Expansion ratio 1 : 2



Polyester PET Schwarz matt				Polyester PET Black matt	
NW	ø min mm	ø max mm	OFB %	Art.-Nr.   Art. No.	
3	3	6	86	6875.40.03	200
4	4	8	85	6875.40.04	200
5	3	10	89	6875.40.05	200
8	6	14	81	6875.40.08	150
10	8	20	79	6875.40.10	150
15	13	25	81	6875.40.15	100
20	15	30	77	6875.40.20	100
24	24	38	82	6875.40.24	100
36	34	60	78	6875.40.36	100
50	45	80	82	6875.40.50	50

OFB = Oberflächendeckung      OFB = Percentage of the surface covered by fabric



Polyester PET Grau matt				Polyester PET Grey matt	
NW	ø min mm	ø max mm	OFB %	Art.-Nr.   Art. No.	
3	3	6	86	6875.70.03	200
4	4	8	85	6875.70.04	200
5	3	10	89	6875.70.05	200
8	6	14	81	6875.70.08	150
10	8	20	79	6875.70.10	150
15	13	25	81	6875.70.15	100
20	15	30	77	6875.70.20	100
24	24	38	82	6875.70.24	100
36	34	60	78	6875.70.36	100
50	45	80	82	6875.70.50	50

OFB = Oberflächendeckung      OFB = Percentage of the surface covered by fabric

### Spenderbox | Dispenser Box



Schwarz				Black	
NW	ø min mm	ø max mm	i info	Art.-Nr.   Art. No.	
5	3	10	12 m	6875.40.05.10	1
10	8	20	12 m	6875.40.10.10	1
18	18	27	6 m	6875.40.18.06	1
30	23	50	6 m	6875.40.30.06	1

### AGROflex PA Geflechschläuche Polyamid

### AGROflex PA Braided cable sleeveings polyamide

Material: Polyamid PA 6  
 Monofil: Ø 0.25mm  
 Eigenschaften: Hochflexibel, selbstanpassend, abriebfest, frei von Cadmium, Formaldehyd, Halogen und Graphit, selbstverlöschend nach DIN 75200 (FMVSS 302), gute Beständigkeit gegen Kraftstoffe, Mineralöle und viele weitere Chemikalien

Material: Polyamide PA 6  
 Monofil: Ø 0.25mm  
 Properties: Highly flexible, self-adapting, resistant to abrasion, free of cadmium, formaldehyde, halogen and graphite, self-extinguishing acc. to DIN 75200 (FMVSS 302), good resistance to fuel, mineral oil and many other chemicals

Einsatztemperatur: -40°C / +125°C  
 Aufweitung: Aufstauchverhältnis 1 : 2

Temperature range: -40°C / +125°C  
 Expansion: Expansion ratio 1 : 2



Polyamid PA 6 Schwarz				Polyamide PA 6 Black	
NW	ø min mm	ø max mm	OFB %	Art.-Nr.   Art. No.	
3	2.5	6.0	85	6850.40.03	100
4	3.0	8.5	91	6850.40.04	100
5	4.0	10.0	95	6850.40.05	100
6	4.0	9.0	85	6850.40.06	100
8	6.0	11.0	90	6850.40.08	100
10	7.0	13.5	90	6850.40.10	100
12	9.0	17.0	94	6850.40.12	100
14	10.0	22.0	85	6850.40.14	100
16	14.0	23.0	87	6850.40.16	100
18	16.0	24.0	88	6850.40.18	100
20	18.0	27.0	83	6850.40.20	100
22	18.0	32.0	84	6850.40.22	50
24	21.0	34.0	71	6850.40.24	50
25	18.0	34.0	85	6850.40.25	50
30	26.0	40.0	88	6850.40.30	50
35	28.0	40.0	88	6850.40.35	50
40	28.0	42.0	93	6850.40.40	50
45	38.0	58.0	84	6850.40.45	50
50	35.0	80.0	88	6850.40.50	50
70	55.0	80.0	91	6850.40.70	50

OFB = Oberflächendeckung  
 Grau auf Anfrage

OFB = Percentage of the surface covered by fabric  
 Colour grey on request



1  
2  
3  
4  
5  
6  
7  
8  
9  
10  
11  
12

# AGRO Geflechschläuche Kunststoff

## AGRO synthetic braided cable sleeving

### AGROflip B selbstschließender Geflechschlauch | AGROflip B self-closing braided sleeving

#### AGROflip B selbstschließender Geflechschlauch

Material:	Polyester PET
Monofil:	Ø 0.25mm
Einsatzbereich:	Problemloses Einziehen von vorkonfektionierten Kabeln, für nachträgliche Installation
Eigenschaften:	Hochflexibel, selbstanpassend, abriebfest, frei von Cadmium, Formaldehyd, Halogen und Graphit, selbstverlöschend nach DIN 75200 (FMVSS 302), gute Beständigkeit gegen Kraftstoffe, Mineralöle und viele weitere Chemikalien
Einsatztemperatur:	-50°C / +150°C

#### AGROflip B self-closing braided sleeving

Material:	Polyester PET
Monofil:	Ø 0.25mm
Application:	Sinking of pre-connected cables without problems, for additional installation
Properties:	Highly flexible, self-adapting, resistant to abrasion, free of cadmium, formaldehyde, halogen and graphite, self-extinguishing acc. to DIN 75200 (FMVSS 302), good resistance to fuel, mineral oil and many other chemicals
Temperature range:	-50°C / +150°C



AGROflip B  
Schwarz

AGROflip B  
Black

NW	ø max mm	Art.-Nr.   Art. No.	
6	6	6878.40.06	25
9	9	6878.40.09	25
13	13	6878.40.13	25
19	19	6878.40.19	20
25	25	6878.40.25	20
32	32	6878.40.32	20
38	38	6878.40.38	20
50	50	6878.40.50	20

Nominaler Innendurchmesser mit einer Überlappung von 25% / 90°

Nominal inner diameter with 25% / 90° overlap



**Thermischer Schutz bei hohen Temperaturen**  
Thermal protective qualities for high-temperature applications

Mit den AGROtube FRS Glasseidenschläuchen erweitert die KAISER Gruppe das Angebot an Geflechtschläuchen um Produkte für Einsätze in Hochtemperaturbereichen.

### Eigenschaften

Die Geflechte aus Glasfäden sind mit einer strapazierfähigen Silikon dispersion beschichtet, äußerst flexibel, dauerelastisch, scheuerfest, wasserabweisend und temperaturbeständig bis maximal 240°C. Als mechanischer Knick-, Abrieb- und Hitzeschutz sind sie bei der Kabelsatzherstellung unentbehrlich geworden. Die glatten Innenwände ermöglichen ein leichtes und schnelles Durchschieben einzelner Adern.

Als Isolierschläuche mit ausgezeichneten elektrischen Isolationseigenschaften lassen sich AGROtube FRS im Prinzip mit beliebig hoher Durchschlagfestigkeit ausstatten, wobei 2.5 bis 10 kV der Standard ist.

### Anwendungsgebiete

Silikon beschichtete Glasseidenschläuche eignen sich ideal für den Einsatz im Schienenfahrzeugbau, den Bau von Transformatoren, Elektromotoren, Strom- und Messwandlern und für die Automobilindustrie. Die elektrischen Schutzqualitäten sind im Elektromaschinenbau für Drähte und Litzen gefragt. Thermische Schutz Eigenschaften sind für Spulenanschlüsse oder Verbindungsleitungen thermisch hoch beanspruchter Maschinen von Bedeutung.

Ein klassisches Einsatzgebiet dieser Produkte ist die Elektrogeräteindustrie (Weiße Ware), in der es neben guten dielektrischen Werten auf hohe Temperaturbeständigkeit ankommt. Für die Verwendung als Walzenüberzüge z.B. in Durchlauföfen ist dagegen die enorme Abriebfestigkeit und der Antihafteffekt der Beschichtung von besonderer Bedeutung.



**Mechanischer Schutz spannungsführender Leitungen**  
Mechanical kink protection of wires and cords

With the AGROtube FRS braided glass fibre sleeveings, the KAISER group is extending its range of braided sleeveings to include products for use in high-temperature applications.

### Properties

Coated with a heavy-duty silicone dispersion, the meshwork made from glass filaments is extremely flexible, permanently elastic, abrasion-resistant, water-repellent and temperature-resistant up to a maximum of 240°C. As a mechanical kink, abrasion and heat protection, such meshworks have become indispensable in cable set production. The smooth inner walls make it easy and quick to push through individual leads.

As insulation tubes with excellent electric insulation properties, AGROtube FRS can in principle be endowed with any degree of electric strength, the standard strength being 2.5 to 10 kV.

### Areas of application

Silicone-coated braided glass fibre sleeveings are ideally suited for use in the construction of rail vehicles, transformers, electric motors, current and instrument transformers, and in the automobile industry. The electric protective qualities are sought after in the construction of electric motors for wires and cords. Thermal protective properties are important for coil connections or connecting lines of machines under intense thermal conditions.

A classic application area of these products is the electric appliances industry (whiteware) where both good dielectric values and high temperature resistance are vital.

In contrast, for use as roll covers, e.g. in continuous furnaces, high abrasion resistance and the anti-adhesive effect of the coating are of great importance.





# AGROtube FRS Glasseidenschläuche mit Silikonummantelung

## AGROtube FRS Braided glass fibre sleeving with silicone coating

### Glasseidenschlauch mit Silikonbeschichtung | Braided glass fibre sleeve with silicone sheath

Material:	Glasseide	Material:	E-glass braid
Beschichtung:	Silikon FRS	Sheath:	Silicone FRS
Eigenschaften:	Hochflexibel, abriebfest, hitzebeständig mit vorzüglichen elektrischen Eigenschaften. Nicht adhäsive Oberfläche mit hervorragender Öl- und Dieselmotoren-Beständigkeit	Characteristics:	highly flexible, abrasion resistant, heat-resisting with excellent electric properties. Non adhesive surface with outstanding oil and diesel fuel resistance
Brandverhalten:	FMVSS 302 (DIN 75200)	Flammability:	FMVSS 302 (DIN 75200)
Einsatztemperatur:	-40°C / +240°C	Temperature range:	-40°C / +240°C
Durchschlagsfestigkeit (DF):	4.0 kV	Dielectric strength: (DS):	4.0 kV

#### AGROtube FRS

Typ.-Nr.	Glasseidenschläuche					Braided glass fibre sleeve					
	transparent	gelb	schwarz	grün	rot	Ø I Code	DF DS	Ø I mm	Ø A mm		
6877	10	30	40	50	60	010	40	1.0	1.8	50	
6877	10	30	40	50	60	015	40	1.5	2.3	50	
6877	10	30	40	50	60	020	40	2.0	2.8	50	
6877	10	30	40	50	60	025	40	2.5	3.4	50	
6877	10	30	40	50	60	030	40	3.0	3.9	50	
6877	10	30	40	50	60	035	40	3.5	4.4	50	
6877	10	30	40	50	60	040	40	4.0	4.9	50	
6877	10	30	40	50	60	045	40	4.5	5.4	50	
6877	10	30	40	50	60	050	40	5.0	6.0	50	
6877	10	30	40	50	60	060	40	6.0	7.0	50	
6877	10	30	40	50	60	070	40	7.0	8.0	50	
6877	10	30	40	50	60	080	40	8.0	9.0	50	
6877	10	30	40	50	60	090	40	9.0	10.0	50	
6877	10	30	40	50	60	100	40	10.0	11.2	50	
6877	10	30	40	50	60	120	40	12.0	13.2	50	
6877	10	30	40	50	60	140	40	14.0	15.4	50	
6877	10	30	40	50	60	160	40	16.0	17.4	50	
6877	10	30	40	50	60	180	40	18.0	19.4	50	
6877	10	30	40	50	60	200	40	20.0	21.5	50	
6877	10	30	40	50	60	220	40	22.0	23.5	50	
6877	10	30	40	50	60	250	40	25.0	26.5	50	
6877	10	30	40	50	60	280	40	28.0	29.6	50	
6877	10	30	40	50	60	300	40	30.0	31.6	50	



So definieren Sie die Produktnummer:  
That's how to compose the product number:

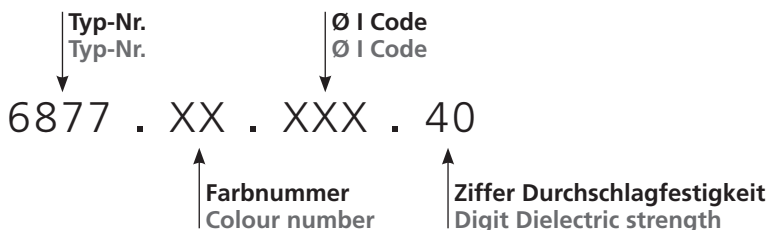

6877.50.035.40 ist ein grüner Schlauch mit Innendurchmesser 3.5 mm und einer Durchschlagfestigkeit von 4.0 kV  
6877.50.035.40 stands for a green sleeving with inner diameter of 3.5 mm and a dielectric strength of 4.0 kV



# AGROtube FRS Glasseidenschläuche mit Silikonummantelung

## AGROtube FRS Braided glass fibre sleeving with silicone coating

### Glasseidenschlauch mit Silikonbeschichtung | Braided glass fibre sleeve with silicone sheath

Material:	Glasseide	Material:	E-glass braid
Beschichtung:	Silikon FRS	Sheath:	Glass fibre
Eigenschaften:	Hochflexibel, abriebfest, hitzebeständig mit vorzüglichen elektrischen Eigenschaften. Nicht adhäsive Oberfläche mit hervorragender Öl- und Dieselmotorenstoff-Beständigkeit	Characteristics:	Silicone FRS highly flexible, abrasion resistant, heat-resisting with excellent electric properties. Non adhesive surface with outstanding oil and diesel fuel resistance
Brandverhalten:	FMVSS 302 (DIN 75200)	Flammability:	FMVSS 302 (DIN 75200)
Einsatztemperatur:	-40°C / +240°C	Temperature range:	-40°C / +240°C
Durchschlagsfestigkeit (DF):	7.0 kV	Dielectric strength: (DS):	7.0 kV

#### AGROtube FRS

Glasseidenschläuche						Braided glass fibre sleeve					
Typ.-Nr.	transparent transparent	gelb yellow	schwarz black	grün green	rot red	Ø I Code	DF DS	Ø I mm	Ø A mm		
6877	10	30	40	50	60	010	70	1.0	1.8	50	
6877	10	30	40	50	60	015	70	1.5	2.3	50	
6877	10	30	40	50	60	020	70	2.0	2.8	50	
6877	10	30	40	50	60	025	70	2.5	3.4	50	
6877	10	30	40	50	60	030	70	3.0	3.9	50	
6877	10	30	40	50	60	035	70	3.5	4.4	50	
6877	10	30	40	50	60	040	70	4.0	4.9	50	
6877	10	30	40	50	60	045	70	4.5	5.4	50	
6877	10	30	40	50	60	050	70	5.0	6.0	50	
6877	10	30	40	50	60	060	70	6.0	7.0	50	
6877	10	30	40	50	60	070	70	7.0	8.0	50	
6877	10	30	40	50	60	080	70	8.0	9.0	50	
6877	10	30	40	50	60	090	70	9.0	10.0	50	
6877	10	30	40	50	60	100	70	10.0	11.2	50	
6877	10	30	40	50	60	120	70	12.0	13.2	50	
6877	10	30	40	50	60	140	70	14.0	15.4	50	
6877	10	30	40	50	60	160	70	16.0	17.4	50	
6877	10	30	40	50	60	180	70	18.0	19.4	50	
6877	10	30	40	50	60	200	70	20.0	21.5	50	
6877	10	30	40	50	60	220	70	22.0	23.5	50	
6877	10	30	40	50	60	250	70	25.0	26.5	50	
6877	10	30	40	50	60	280	70	28.0	29.6	50	
6877	10	30	40	50	60	300	70	30.0	31.6	50	



So definieren Sie die Produktnummer:  
That's how to compose the product number:

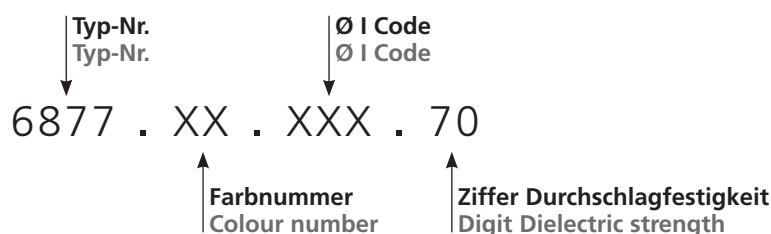

6877.50.035.70 ist ein grüner Schlauch mit Innendurchmesser 3.5 mm und einer Durchschlagfestigkeit von 7.0 kV.  
6877.50.035.70 stands for a green sleeving with inner diameter of 3.5 mm and a dielectric strength of 7.0 kV



Prüfzeichen Approval Marks	<b>240 - 241</b>	1
Brandschutz für Schienenfahrzeuge nach EN 45545 Fire protection in railway vehicles according to EN 45545	<b>242 - 243</b>	2
Progress® Baukasten und Sonderlösungen Progress® modular assembly parts and special solutions	<b>244 - 249</b>	3
Prüftechnik Test laboratory	<b>250 - 251</b>	4
Montageanleitungen Kabelverschraubungen Assembly instructions cable glands	<b>252 - 255</b>	5
Digitaler Service Digital service	<b>256</b>	6
Verzeichnis der Schutzarten (IP) List of Protection Classes (IP)	<b>257</b>	7
Materialübersichtstabellen List of materials	<b>258 - 261</b>	8
Gewindetabelle Chart of threads	<b>262</b>	9
Suchhilfen Search helps	<b>263 - 275</b>	10
Liefer- und Zahlungsbedingungen Terms and conditions of delivery and payment	<b>276 - 277</b>	11
Vertretungen National/International National/International agencies	<b>278 - 279</b>	<b>12</b>



### SEV

Das SEV-Bewilligungszeichen wird auf Grund bestandener Prüfungen bei ElectroSuisse vom ESTI erteilt. Grundlage für Kabelverschraubungen ist hierbei die europäische Norm EN 50262 / EN 62444.

### SEV

The SEV mark of approval is awarded by ESTI as a result of tests conducted by ElectroSuisse. European standard EN 50262 / EN 62444 forms the basis for cable glands.



### VDE

Das VDE-Zeichen kennzeichnet die Konformität mit den VDE-Bestimmungen bzw. europäischen oder international harmonisierten Normen und bestätigt die Einhaltung der Schutzanforderungen der zutreffenden Richtlinien. Das VDE-Zeichen steht für die Sicherheit des Produktes hinsichtlich elektrischer, mechanischer, thermischer und sonstiger Gefährdung.

### VDE

The VDE certification mark signals conformity with the VDE provisions and European or internationally harmonised standards and confirms that the safety requirements fulfil the applicable guidelines. The VDE mark stands for the safety of the product in terms of electrical, mechanical, thermal and other hazards.



### C-UL / US Listing Zeichen

Dieses Prüfzeichen wird bei Produkten verwendet, die auf kanadischen und U.S.-Märkten vertrieben werden. Es weist darauf hin, dass die kanadischen und die U.S.-Anforderungen für klassifizierbare Produkte erfüllt wurden.

### C-UL / US Listing Mark

This approval mark is used for products that are distributed in the US and Canadian markets. It indicates that the US and Canadian specifications for classifiable products have been fulfilled.



### Recognized Component Zeichen für Kanada und die USA

Das Recognized Component Mark von UL darf für Komponenten verwendet werden, die Bestandteil eines größeren Produktes oder Systems sind. Diese sind von UL gemäß kanadischen und U.S.-Anforderungen zertifiziert.

### Recognized Component Mark for Canada and the USA

The UL Recognized Component Mark can be used for components that are part of a larger product or system. These are certified by UL in accordance with US and Canadian requirements.



Das **GOST-R-Zertifizierungszeichen** kennzeichnet die Übereinstimmung der Produkte mit russischen Richtlinien und Normen. Grundlage dafür bilden das russische Verbraucherschutzgesetz sowie das Gesetz zur Zertifizierung von Gütern und Dienstleistungen. Produkte welche in Russland produziert wurden, sowie Importwaren müssen den jeweiligen Standards entsprechen, wenn sie in den russischen Markt gelangen.

The **GOST-R certification mark** indicates that products conform to the Russian guidelines and standards. The basis is given by the Russian consumer protection act and the law governing the certification of goods and services. Products produced in Russia, as well as imported goods, must conform to the relevant standards when they appear on the Russian market.

**Det Norske Veritas (DNV)** ist eine Schiffsklassifikations-Gesellschaft in Form einer Stiftung. Sie klassiert und erteilt Zertifikate zum unbedenklichen Einsatz von Produkten auf Schiffen. DNV wurde 1864 in Oslo gegründet

**Det Norske Veritas (DNV)** is a maritime classification society organized as a foundation. It classifies and issues certificates for the safe use of materials and components on ships. DNV was founded in 1864 in Oslo.



1

Die **Internationale Elektrotechnische Kommission**, kurz: IEC (von engl. International Electrotechnical Commission) ist eine internationale Normungsorganisation mit Sitz in Genf für Normen im Bereich der Elektrotechnik und Elektronik.

The **International Electrotechnical Commission (IEC)** is an international standards organisation with its headquarters in Geneva which develops standards in the areas of electrical equipment and electronics.



2

Das IEC Ex-Prüfzeichen ist eine spezielle Kennzeichnung für Explosionsschutz Einrichtungen. Es bedeutet, dass Einrichtungen, Schutzsysteme oder Bauteile den Anforderungen der internationalen und europäischen Norm entsprechen, die mit der Richtlinie 94/9/EC (ATEX-Direktive, benannt nach der französischen Bezeichnung „ATmosphère EXplosible“) harmonisiert sind.

The IEC Ex mark of conformity is a special identification for equipment and services used in explosive atmospheres. It means that equipment, protective systems or components meet the requirements of the international and European standard which are harmonised with Directive 94/9/EC (the ATEX directive, named after the French designation "ATmosphères EXplosives").



4

5

„**Restriction of the use of certain Hazardous Substances in electronic equipment**“ ist der Titel der EU-Richtlinie 2002/95/EG. Sie verbietet ab 1.7.2006 im gesamten Gebiet der EU den Verkauf von elektrischen Geräten, welche mehr als nur Spuren von Blei, Cadmium, Chrom VI, Quecksilber oder von polybromierten Flammschutzmitteln PBB/PBDE enthalten.

“**Restriction of the use of certain Hazardous Substances in electronic equipment**“ is the title of EC Directive 2002/95/EC. With effect from 1 July 2006, it forbids the sale of electric equipment which contain more than traces of lead, cadmium, chromium(VI), mercury or polybrominated flame retardants (PBBs and PBDEs) throughout the entire EC.

# RoHS

6

7

Die neue Norm EN 45545 Brandschutz in Schienenfahrzeugen ist seit Juni 2013 in Kraft und bringt innerhalb Europas eine Vereinheitlichung. Nationale Normen wie DIN 5510-2, NFF 16101 / 102 oder UNICEI 11170 werden bis März 2016 zurückgezogen.

Die neue Brandschutznorm setzt sich aus mehreren Teilen zusammen. Teil 1 umfasst allgemeine Regeln, Teil 2(EN 45545-2) definiert die Anforderungen an das Brandverhalten von Materialien und Komponenten nach verschiedenen Gefährdungsstufen (Hazard Level). Teil 2 ist in Bezug auf gefährliche Rauchgase sehr wichtig. Teil 3 (EN 45545-3) definiert den Feuerwiderstand von Feuerschutzabschlüssen (Raumabschluss).

The new standard EN 45545 Fire protection on railway vehicles came into effect in June 2013, bringing standardisation across Europe. National standards such as DIN 5510-2, NFF 16101 / 102 and UNICEI 11170 will be withdrawn by March 2016.

The new fire protection standard consists of several parts. While Part 1 covers general requirements, Part 2 (EN 45545-2) outlines requirements for fire behaviour of materials and components according to various Hazard Levels. Part 2 is very important in relation to dangerous smoke gases. Part 3 (EN 45545-3) defines fire resistance requirements for fire barriers.



9

10

11

12

# AGRO Kabelverschraubungen sind zertifiziert nach EN 45545-2

## AGRO cable glands are certified according to EN 45545-2

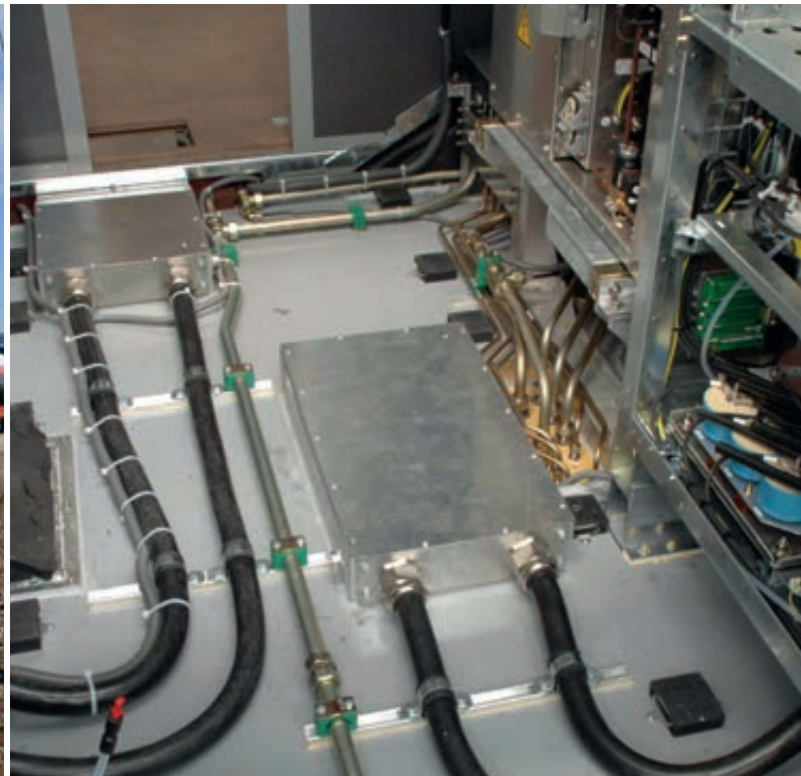

### AGRO Progress® bedenkenlos für Schienenfahrzeuge

Progress® Kabelverschraubungen aus Metall können bedenkenlos für alle Anwendungen und Anordnungen im Schienenfahrzeugbereich eingesetzt werden. Dies bescheinigt das neue Zertifikat.

Die herausragende Progress® Kompressionstechnik sorgt für eine hohe Dichtigkeit und eine äußerst kabelschonende Zugentlastung auch bei dynamischen Anwendungen. Standard- und EMV-Kabelverschraubungen mit dem entsprechenden Zubehör bilden das Basissortiment für nahezu alle Anwendungen. Die KAISER Gruppe fertigt bei Bedarf auch zertifizierte Lösungen gemäß Anforderungen der Kunden.

### Beste Resultate bei Prüfungen nach EN 45545-2 (Komponenten)

Die Dichteinsätze der Progress® Kabelverschraubung sind aus einem speziellen TPE gefertigt und sind im anspruchsvollsten **Hazard Level 3 zertifiziert**.

Die geforderten Werte für Hazard Level 3 wurden sowohl im Außen- als auch im Innenbereich deutlich übertroffen:

	Normwert für HL 3 außen Requirement for HL 3 outdoor	Normwert für HL 3 innen Requirement for HL 3 indoor	AGRO Resultat AGRO result
Sauerstoffindex   Oxygen index	Min. 32%	Min. 32%	<b>39%</b>
Rauchgasdichte Ds   Smoke gas density Ds	Max. 300	Max. 150	<b>110</b>
Toxizität CIT   Toxicity CIT	Max. 1.5	Max. 0.75	<b>0.16</b>

### AGRO Progress® - the ideal solution for rolling stock

Progress® metal cable glands can be used with confidence for any rolling stock application, in any arrangement, as has been recently certified.

The outstanding Progress® compression technology ensures tight seals and offers cables exceptional damage-preventing strain relief, even in dynamic applications. A comprehensive range of standard and EMC cable glands and accessories offers a solution for almost any application. Where the need arises, the KAISER group also delivers certified solutions according to customer requirements.

### Best results in testing according to EN 45545-2 (Components)

The seal inserts of Progress® cable glands are made from a special TPE and certified to the demanding **Hazard Level 3**.

The stipulated values for Hazard Level 3 were exceeded, for both indoor and outdoor areas:

## Kabelverschraubungen zertifiziert für den Einsatz in Schienenfahrzeugen

### Cable glands certified for rolling stock applications



**Material:** Messing vernickelt  
**Material Dichteinsatz:** Spezial AGRO TPE  
**Farbe Dichteinsatz:** Hellgrau RAL 7035  
**Gewinde:** M12 bis M63  
Pg 7 bis Pg48  
**Einsatztemperatur:** -50°C / +105°C  
**Schutzart:** IP 68 / IP 69 K  
**Weitere Normen:** EN 50262 / EN 62444

**Material:** Nickel-plated brass  
**Material sealing insert:** Special AGRO TPE  
**Colour sealing insert:** Light grey RAL 7035  
**Threads:** M12 to M63  
Pg 7 to Pg48  
**Temperature range:** -50°C / +105°C  
**Protection class:** IP 68 / IP 69 K  
**Further norms:** EN 50262 / EN 62444





# AGRO Kabelverschraubungen sind zertifiziert nach EN 45545-3

## AGRO cable glands are certified according to EN 45545-3

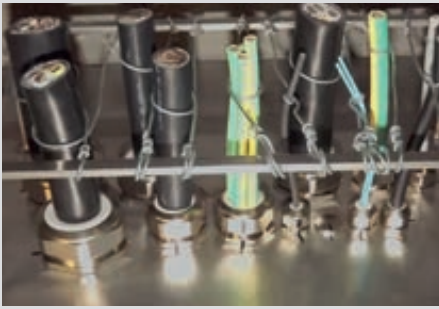

Ausgangssituation | Initial situation

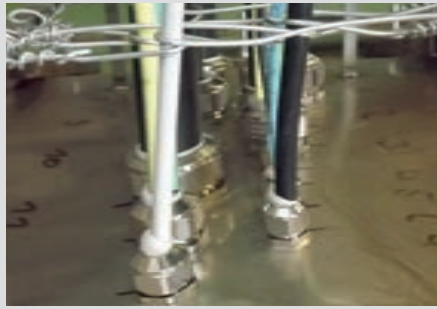

Nach 10 Minuten | After 10 minutes



Nach 20 Minuten | After 20 minutes



Nach 30 Minuten | After 30 minutes



Nach 35 Minuten | After 35 minutes



Nach 44 Minuten | After 44 minutes

### Vorgaben der EN 45545-3 übertroffen!

Die EN 45545-3 definiert die Anforderungen an den Feuerwiderstand für Feuerschutzabschlüsse. Ziel der EN 45545-3 ist es, die Brandausbreitung durch Materialanforderungen zu begrenzen. Wenn Kabel durch Feuerschutzabschlüsse geführt werden, gelten diese Anforderungen auch für Kabelverschraubungen.

Um festzustellen, ob der geforderte Feuerwiderstand erreicht wird, werden die Komponenten in einem Prüfofen in Hinblick auf die Kriterien Raumabschluss, Wärmedämmung und Strahlenemission geprüft.

Progress® Kabelverschraubungen aus Metall übertreffen die Vorgaben der EN 45545-3 bei weitem und erreichen die sehr hohe Feuerwiderstandsklasse E30. Dies bedeutet, dass die Dichteinsätze mindestens 30 Minuten lang dicht sind und einen Flammenübertrag auf die dem Feuer abgewandte Seite verhindern. Es bilden sich keine Spalten. Sie können aus brandschutztechnischer Sicht bedenkenlos in allen Schienenfahrzeugen eingesetzt werden.

### Exceeding the demands of EN 45545-3!

EN 45545-3 defines the requirements for fire resistance of fire barriers. The aim of EN 45545-3 is to limit fire spread by specifying the performance of materials and components. If cables are routed through fire barriers, the requirements apply also to the cable glands used.

In order to establish whether or not the required fire resistance is achieved, components are tested in a testing furnace with respect to requirements for fire barrier, thermal insulation and radiation emission.

Progress® metal cable glands easily exceed the requirements of EN 45545-3 and satisfy the very high demands of fire resistance class E30. This means that the seal inserts remain impervious and prevent the spread of fire through the gland for at least 30 minutes. They do not crack or fissure. From a fire protection perspective, they can be used without hesitation in all railway vehicles.



EN 45545-3  
E30

	Einbaulage vertikal Vertical installation	Einbaulage horizontal Horizontal installation	Klassierung Classification
AGRO Resultat AGRO Result	44 min	41 min	E30

Der Brandversuch wurde durchgeführt mit Progress® Kabelverschraubungen Messing vernickelt und Dichteinsätzen aus Spezial AGRO TPE, Größen M16 bis M50, sowie mit Multi-Kabelverschraubungen und Verschlusschrauben.

Fire testing was carried out using Progress® nickel-plated brass cable glands and seal inserts of Special AGRO TPE, sizes M16 to M50, and with multi-cable glands and locking screws.



# Progress®: Der Baukasten – Messing

## Progress®: Modular assembly parts – nickle-plated brass

Progress®-Bauteile können frei kombiniert werden

Progress® components are freely combineable

### Oberteil / Upper part



Standard-Druckmutter  
Standard compression nut



Knickschutz  
Antikink spring



Trompete  
Trumpet



Klemmbacken und Trompete  
Trumpet with clamps



Klemmbacken  
Clamps



Schlauchverschraubungen  
Conduit glands

### Dichteinsatz / Sealing inserts



Kurzer ein- oder zweiteiliger Dichteinsatz in NBR/TPE, Spezial TPE nach EN 45545 oder FPM (temperaturbeständig)  
Short one or two-piece sealing insert made of NBR, TPE, special TPE according to EN 45545 or FPM (heat resistant)

Langer durchgehend isolierender Dichteinsatz in NBR/TPE oder Spezial TPE nach EN 45545, ein- oder zweiteilig / Long one or two-piece overall length insulating sealing insert made of NBR/TPE, special TPE acc. to EN 45545

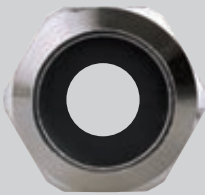

mit Standard-Bohrungen  
with standard holes



mit individuellen Öffnungen  
with customised holes



### Unterteil / Lower Part



mit kurzem Anschlussgewinde  
with short entry thread

- metrisch / metric
- Pg / Pg
- NPT / NPT
- Gasrohr / gaspipe



mit langem Anschlussgewinde  
with long entry thread

- metrisch / metric
- Pg / Pg
- NPT / NPT
- Gasrohr / gaspipe



**Kundenspezifische Bauformen sind prinzipiell auf jeder Stufe des Baukastens möglich.**  
Customisations are possible essentially at every stage of the building block approach.

## Kundenspezifische Oberteile Customised upper parts



Oberteile können im Hinblick auf die Bauform und das Gewinde kundenspezifisch gefertigt werden.

In Zusammenarbeit mit den Kunden wird ein Bauteil entwickelt, welches den individuellen Anforderungen am Besten entspricht und den optimalen Nutzen bietet.

Upper parts can be customised for shape and thread. By working closely with the customer, a component is developed which best meets individual requirements and offers superior benefit to the user.

## Kundenspezifische Dichteinsätze Customised sealing inserts



Die Lochform und die Anzahl der Durchführungen sowie die verwendeten Werkstoffe können bei den Dichteinsätzen anwendungsfalloptimiert angepasst werden. Wir bearbeiten folgende Materialien:

- NBR
- TPE
- TPE-V
- FPM
- Silikonkautschuk
- HNBR
- EPDM
- Spezial TPE

Sealing inserts can be customised for shape and number of feedthroughs and also with regard to the selection of material. We work with the following materials:

- NBR
- TPE
- TPE-V
- FPM
- Silicone caoutchouc
- HNBR
- EPDM
- Special TPE

## Kundenspezifische Unterteile Customer-specific lower parts



Unterteile können im Hinblick auf die Bauform und das Anschlussgewinde kundenspezifisch gefertigt werden. Alle technischen Gewinde sind möglich.

Lower parts can be customised for type and length of the entry thread. All technical thread types are available.

# Sonderlösung Schienenfahrzeug

## Special solutions for railway vehicles

### Anforderungen

- EMV-gerechte Einführung von sechs ungeschirmten Kabeln
- Verbindung Stromrichter - Trafo
- Schutzart IP 68 innen und außen. Dadurch wird verhindert, dass Kondenswasser, welches sich möglicherweise innerhalb des Schlauches bildet, in den Traforaum eindringt

### Lösung

- Progress®-Spezialverschraubung M75 mit geschlitztem Multi-Dicht-einsatz zur leichteren Kabelmontage
- kombiniert mit Metallschutzschlauch

### Requirements

- EMC-proof feedthrough of six unshielded cables
- Connection from power rectifier to transformer
- Protection class IP 68 inside and out. This prevents condensate which could possibly build up inside the conduits from making its way into the transformer room

### The solution

- Progress® M75 special cable gland with slotted multi-sealing insert for easier cable assembly
- Combined with metal conduit

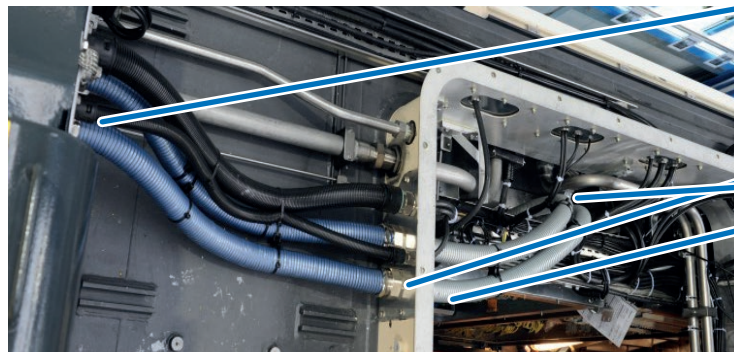



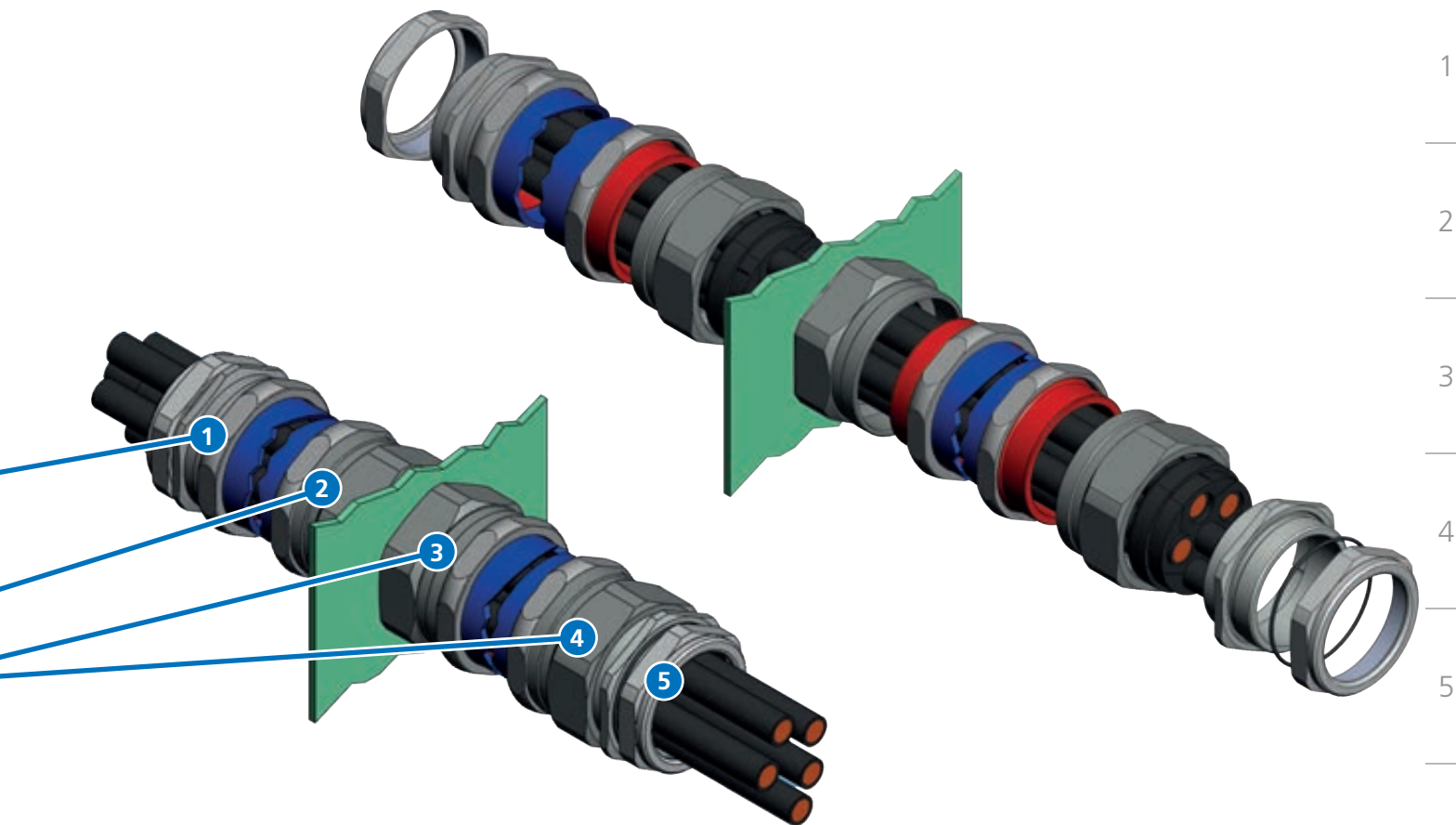

- 1 Schlauchverschraubung zur Befestigung des Metall-Kabelschutzschlauches. Innerhalb des Schutzschlauches werden sechs Stromkabel geführt. Der Metallschutzschlauch funktioniert über seine Verbindung mit den Gehäusen aus Metall als äußerer EMV-Schutz
- 2 Kombi-Schlauchverschraubung mit Progress® Multi-Dichteinsatz zur dichten Einführung der Kabel in den Traforaum (Schutz vor Feuchtigkeit von außen)
- 3 Schlauchverschraubung zur Aufnahme des Metallschutzschlauches (Weiterführung des EMV-Schutzes)
- 4 Kombi-Schlauchverschraubung (identisch mit 2) zur Einführung der Kabel in den Trafo (Schutz vor Feuchtigkeit von innen)
- 5 Gegenmutter zur Befestigung der Kombi-Schlauchverschraubung

- 1 Conduit gland to secure the metal conduit. Six power cables are run within the conduit. The metal conduit functions as an exterior EMC shield through its connection with the metal enclosures
- 2 Combination conduit gland with Progress® multi-sealing insert for sealed cable feedthrough into the transformer room (protection from outside moisture)
- 3 Conduit gland to accept the metal conduit (extension of EMC protection)
- 4 Combination conduit gland (identical to #2) for cable feedthrough into the transformer room (protection from interior moisture)
- 5 Locknut to secure the combination conduit gland

# Sonderlösung Kabelverschraubung Knabberschutz

## Rodent-proof special cable gland solution



© ABB

### Wenn Nager zum Sicherheitsrisiko werden

Manch einer kennt das Phänomen aus eigener Erfahrung: das Auto will sich am Morgen nicht starten lassen, und der Reparaturdienst stellt fest, dass Gummiteile von Mardern weggefressen worden sind.

Marder, Nager und Vögel lieben Gummi. Die Konsistenz und der Duft von Gummi zieht Kleintiere an und sie knabbern ihn an. Frei geknabberte Kabel führen zu Kurzschlüssen und Funktionsstörungen. Wenn ummantelte Kabel in einem natürlichen Umfeld eingesetzt werden, so muss mit einem Nagerschaden gerechnet werden und entsprechende Vorsichtsmaßnahmen sind sinnvoll.



Nagerschaden an Kabel / Rodent damage to a cable

ABB baut Schaltanlagen, die in der ganzen Welt unter unterschiedlichsten Umweltbedingungen eingesetzt werden.

Möglichen Schäden durch Nager wird standardmässig vorgebeugt, indem die Kabel, welche Generatorschutzschalter und Steuerschrank verbinden, in einem mit Polyurethan ummantelten flüssigkeitsdichten Schlauch mit Stahlwendel geführt werden. Zur dichten Einführung (IP 68) der im Schlauch geführten Kabel entwickelte die KAISER Gruppe in Zusammenarbeit mit ABB eine kundenspezifische Lösung, welche eine feuchtigkeitsdichte Verbindung von Schlauch- und Kabelverschraubung sowie einen sicheren EMV Abgriff ermöglicht. Mit dieser Lösung werden zwei Probleme auf einmal gelöst: die Kabelführung und -Einführung ist feuchtigkeitsdicht und vor Nagern geschützt.

### When rodents become a safety risk

Many of us know the phenomenon from personal experience: the car just won't start in the morning and the mechanic finds that rubber parts have been gnawed away by martens.

Just like martens, rodents and also birds love rubber. Small animals seem to be magically drawn to rubber by its consistency, or maybe its scent, and nibble away at it.

Damaged cables can result in short circuits and loss of functionality. If shrouded cables are to be used in a natural setting, the risk of rodent damage should be recognised and appropriate precautions taken.



Nager sicherer Kabelschutz mit Progress® EMV Serie 85 / Rodent proof cable protection

ABB manufactures gas insulated switchgear that is used all around the world in the most varying environments. Possible damage by rodents is prevented, as standard, by the use of a polyurethane-sheathed, liquid-tight conduit with a steel coil to protect cables connecting circuit breakers and control cabinets.

For the IP 68-compliant entry of the cable into the conduit, the KASIER group developed, in cooperation with ABB, an individualised solution which facilitates a liquid-tight connection of conduit and cable and a reliable EMC tap.

This solution solves two problems at once: the cable route, and in particular the entry point of the cable into the conduit, are liquid-tight, and the cable is also protected from rodents.

### Anforderungen

- Die Anforderungen an die Komponenten von Signalanlagen im Bahnbereich sind erheblich. Eine entscheidende Größe ist die Schlagfestigkeit (Schotterschlag).
- Kabel sollen mit einem Schlauch vor Schotterschlag geschützt werden. Die Verbindung Kabelverschraubung – Schlauch sollte auf möglichst einfache Weise erstellt werden.

### Lösung

- Mit einer speziellen Schlauchanschlusshülse wurde eine einfache und ausreißsichere Aufnahme für den Schutzschlauch geschaffen

**1** Die Standard Progress® Kabelverschraubung wird ergänzt durch die Schlauchanschlusshülse zur Aufnahme des Kabelschutzschlauches.

**2** Eine Dichtkappe verschließt die Kabeleinführung unter Einhaltung der Schutzart IP 68 bis zur Bestückung.

### Requirements

- The requirements on equipment used in signalisation are very high. With railway signalisation, the systems must be impact resistant (from crushed stone).
- Cables must be protected from impact due to crushed stone using conduit. The cable gland/conduit connection must be created in the simplest way possible.

### The solution

- A simple and pull-out resistant attachment to the conduit was created with a special conduit connecting sleeve

**1** The standard Progress® cable gland is enhanced with the conduit connecting sleeve for attachment to the cable conduit.

**2** A sealing cap closes the cable entry with a robust IP 68 seal as long as it is not fitted.

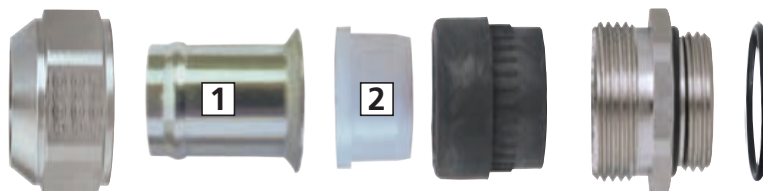

Standard Progress® Kabelverschraubung ergänzt mit einer Schlauchanschlusshülse.

Standard Progress® cable gland enhanced with a conduit connecting sleeve

Spezialausführung Druckmutter mit integrierter Schlauchanschlusshülse.

Special compression nut with integrated conduit connector.

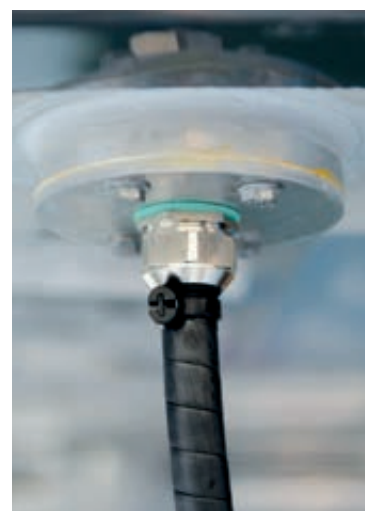

1

2

3

4

5

6

7

8

9

10

11



# Electrosuisse zertifiziert das Prüflabor der AGRO

## Electrosuisse certifies AGRO's test laboratory



Glühdrahttest bei 850°C  
Glow wire test at 850°C



Druckprüfung zur Ermittlung des IP Schutzes  
Pressure test for the determination of the degree of IP protection

Das Arbeiten und Leben mit Strom birgt Risiken. Normen und staatliche Richtlinien wollen diese Risiken minimieren und Installateuren, Monteuren und zu guter Letzt auch dem Endnutzer mehr Sicherheit bieten.

**Geprüfte und zertifizierte Produkte** geben dem Installateur Sicherheit bei der Montage und die Gewissheit, dass das Produkt seine Funktion über viele Jahre erfüllen wird. Außerdem bleibt die abschließende Haftung bei einem durch Electrosuisse zertifizierten Produkt im Schadenfall beim Hersteller der Komponente.

Unser Labor wurde durch Electrosuisse überprüft und mit dem TMP-Zertifikat ausgezeichnet.

TMP bedeutet: Testing at manufacturer premises. Die offizielle Zertifizierungsstelle stellt fest: „Das AGRO-Prüflabor erfüllt die relevanten Kriterien für die Anerkennung von Prüfberichten nach OD ECS 37 und sie entsprechen den Anforderungen von ISO/IEC 17025:2005 (Allgemeine Anforderungen an die Kompetenz von Prüf- und Kalibrierlaboratorien)“. Im Klartext heißt dies: „Die AGRO AG verfügt über das normative Wissen, um Produkte schnell und sicher zu prüfen. Die Prüfberichte des Labors sind die Grundlage für die Zertifizierung eines Produkts durch Electrosuisse.“

Was nutzt das dem Kunden aus der Elektrobranche oder Maschinen- und Automatisierungsindustrie ?

Working and living with electricity inevitably involves risks. Standards and government directives have the goal of minimising these risks and offering additional safety to electricians, fitters and most of all the end user.

**Products which have been tested and certified** provide the fitter with security during installation and assembly, and this testing also provides the certainty that the product will perform its function for many years. Furthermore, the final liability for damage or injury caused by a product certified by Electrosuisse lies with the component manufacturer.

AGRO had its laboratory examined by Electrosuisse because it wanted to receive the **TMP (Testing at Manufacturers' Premises) certificate**. The official certification office established that: "The AGRO test laboratory meets the relevant criteria for recognition of test reports according to OD ECS 37, and they meet the requirements of ISO/IEC 17025:2005 (General requirements for the competence of testing and calibration laboratories)." In simple terms, this means that "AGRO AG has the necessary knowledge of standards and test procedures which allow it to test products quickly and safely. The laboratory's test reports are the basis for having Electrosuisse certify a product." What value does this have for customers from the electrical or machinery sectors or automation industry?



Film: Prüflabor



Film: Test Laboratory



Zugprüfung an einer Kabelverschraubung  
Tensile test on a cable gland



Maßprüfung mittels Messprojektor  
Measurement with a projector

### Im Mittelpunkt der Prüfung

Das erfolgreiche Bestehen der Prüfung durch Electrosuisse gibt dem Anwender die Gewähr, daß die KAISER Gruppe über das normative Wissen verfügt und daß die Laborrichtungen für die Durchführung von Prüfungen dem offiziellen Standard entsprechen.

Begutachtet wurde unter anderem die IP-Druckprüfanlage (Schutzart IPX8 bis 10 MPa (100 bar)) und die Zugprüfmaschinen bis 2.5 kN (250 kg) für das Testen von Kabelverschraubungen, Steckdeckeln, Lampendübeln und anderen Komponenten. Ebenso die Klimaschränke für das Durchführen von Wärmealterungen, die Einrichtungen für die Schlagprüfungen, mit der die Widerstandskategorie von Kabelverschraubungen ermittelt werden, und das Testgerät, mit dem die Glühdrahtfestigkeit an Bauteilen nach IEC (650°C / 850°C) geprüft wird.

### At the focus of testing

By successfully passing the Electrosuisse tests, the manufacturer of a product gives the consumer the assurance that it has the necessary knowledge of standards and test procedures, and that the set-ups for conducting the tests have been judged as being suitable according to official standards. Among the test set-ups evaluated were the ingress protection pressure test system (Protection Class IP X8 up to 10 MPa (100 bar) and tensile testing machines up to 2.5 kN (250 kg) for testing cable glands, socket lids, lamp anchors and other components. Also examined were an environmental chamber for conducting accelerated thermal aging, set-ups for impact tests with which the ruggedness category of cable glands is determined, and the equipment with which the glow wire resistance of components is tested according to IEC (650°C / 850°C).



Oil-Spray Test  
Oil-Spray test



Flexing Test  
Flexing test

Ferner verfügt die KAISER Gruppe über eigens konstruierte Prüfeinrichtungen welche es ermöglichen **nach der amerikanischen UL514B** zu prüfen. Dies beinhaltet den Oil-Spray-, Flexing und pull-out Test sowie die Alterungsprüfung.

Gemäß dem Witness-Verfahren besteht die Möglichkeit auch Prüfungen (Zertifizierungen) für Kabelverschraubungen für den Einsatz in Explosionsgefährdeten Bereichen, welche nach IEC/EN 60079-0 und IEC/EN 60079-1, Zündschutzart „e“ und „d“ zugelassen sind, durchzuführen.

Somit besteht die Möglichkeit bereits in der Entwicklungsphase die Normangaben zu überprüfen und die Erkenntnisse direkt in die weitere Entwicklung der Produkte mit einfließen zu lassen.

Darüber hinaus ist die KAISER Gruppe in zahlreichen Normengremien vertreten.

AGRO has expanded its test laboratory with additional test set-ups and can now conduct oil-spray, flexing and pull-out tests as well as accelerated aging tests in accordance with the requirements of the **American UL 514B standard**.

We are able to conduct witness tests on cable glands for use in explosive atmospheres according to IEC/EN 60079-0 for ignition protection type "e" and IEC/EN 50079-1 for ignition protection type "d".

The ability to conduct in-house tests allows us to verify the non-conformity of new products early in the development stage. The development process can thus be faster and more efficient.

AGRO is represented in the most important national standardisation bodies and takes an active role in the design of future standards.

### Montageanleitung für Kabelverschraubungen Progress® Assembly instruction cable glands Progress®

Das Unterteil der Kabelverschraubung in das entsprechende Gewinde einschrauben.



Screw the lower part of the cable gland into the corresponding thread.

Oder:

Or:

Das Unterteil der Kabelverschraubung in die vorhandene Eintrittsöffnung im Gehäuse einführen und mittels Gegenmutter befestigen.

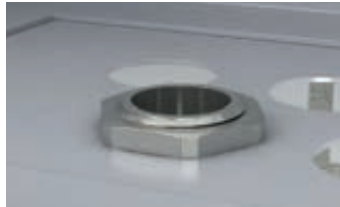

Put the lower part of the cable gland into an existing opening in the enclosure and fix it by means of a lock nut.

Wenn bei zweiteiligen Dichteinsätzen der Kabeldurchmesser das obere Ende des Klemmbereiches der Kabelverschraubung erreicht, muss der innere Teil des Dichteinsatzes entfernt werden.



Remove the inner part of the two-piece sealing insert, in case the cable diameter is close to the upper end of the clamping range of the cable gland.

Kabel, Dichteinsatz und Druckmutter in das Unterteil einführen, Druckmutter von Hand leicht verschrauben.



Insert the cable, sealing insert and the compression nut into the lower part of the cable gland and manually tighten the compression nut.

Druckmutter mit passendem Gabelschlüssel anziehen bis der Dichteinsatz zwischen Druckmutter und Kabel einen kleinen Wulst bildet.



Tighten the compression nut by means of a spanner until the sealing insert forms a small bead between the compression nut and the cable.



## Progress® EMV easyCONNECT Messing Progress® EMC easyCONNECT nickel-plated brass

Kontaktfeder aus dem Unterteil der Kabelverschraubung entfernen.



Remove the contact spring from the lower part of the cable gland.

Das Unterteil der Kabelverschraubung in das entsprechende Gewinde einschrauben oder in die vorhandene Eintrittsöffnung im Gehäuse einführen und mittels Gegenmutter befestigen.



Screw the lower part of the cable gland into the corresponding thread or put it into an existing opening in the enclosure and fix it by means of a lock nut.

Kabel abisolieren.



Strip the cable.

Kontaktfeder auf den Kabelschirm aufsetzen.



Clip the contact spring on the shielded cable.

Wenn bei zweiteiligen Dichteinsätzen der Kabeldurchmesser das obere Ende des Klemmbereiches der Kabelverschraubung erreicht, muss der innere Teil des Dichteinsatzes entfernt werden.



Remove the inner part of the two-piece sealing insert, in case the cable diameter is close to the upper end of the clamping range of the cable gland.

Kabel, Kontaktfeder, Dichteinsatz und Druckmutter in das Unterteil einführen, Druckmutter von Hand leicht verschrauben.



Insert cable, contact spring, sealing insert and the compression nut into the lower part of the cable gland and manually tighten the compression nut.

Druckmutter mit passendem Gabelschlüssel anziehen bis der Dichteinsatz zwischen Druckmutter und Kabel einen kleinen Wulst bildet.



Tighten the compression nut by means of a spanner until the sealing insert forms a small bead between the compression nut and the cable.



Über diesen QR Code erhalten Sie den Zugang zum Montagefilm  
Progress® EMV easyCONNECT Messing.

By activating this QR Code, you will get access to our installation movie  
Progress® EMC easyCONNECT nickel-plated brass.



# Montageanleitung

## Assembly Instructions

### Progress® EMV RAPID

- 1 Komplette Kabelverschraubung (5 Teile) in das vorgesehene Gehäuse einschrauben, ohne die Druckmutter fester anzuziehen.
- 2 Kabelaußenmantel partiell abisolieren oder auf gewünschte Länge zuschneiden.
- 3 Kabel in die Kabelverschraubung einführen, bis der Schirm in der Kontaktscheibe (5) einrastet oder der Kabelmantel an der Scheibe ansteht.
- 4 Druckmutter (1) mit dem Unterteil (4) verschrauben, bis der Dichteinsatz (2) zwischen Druckmutter und Kabel einen kleinen Wulst bildet.

FERTIG!

Die PROGRESS MS EMV RAPID kann durch Ausstoßen der Kontaktscheibe (5) auch ohne Weiterführen des Schirms montiert werden. Siehe dazu Montageanleitung der PROGRESS EMV.

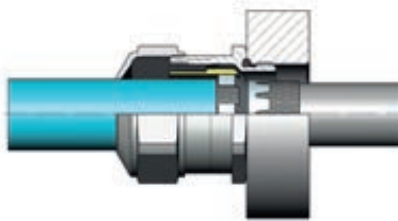
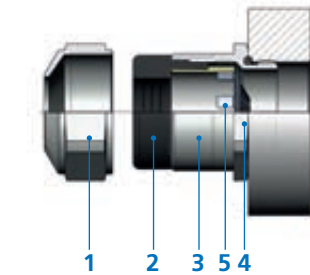

### Progress® EMV RAPID

- 1 Screw in the complete cable gland (5 parts) into the intended housing without further tightening the compression nut.
- 2 Partially dismantle the outer cable sleeve or trim to the desired length.
- 3 Feed cable into the cable gland until the shielding snaps into the contact disk (5) or the cable sheath contacts the disc.
- 4 Tighten compression nut (1) to the lower gland part (4) until the sealing insert (2) forms a small ridge between the compression nut and the cable.

FINISHED!

The PROGRESS MS EMV RAPID can also be mounted by extruding the contact disc (5) without extending the shield. See the PROGRESS EMV assembly instructions.

### Progress® EMV

- 1 Unterteil (4) der Kabelverschraubung in das vorgesehene Gehäuse einschrauben.
- 2 Druckmutter (1), Dichteinsatz (2) und Kontakthülse (3) über das Kabel ziehen.
- 3 Außenmantel des Kabels auf die gewünschte Länge zurückschneiden.
- 4 Schirmumflechtung oder Schirmfolie ungefähr auf Kontakthülslänge X zuschneiden.
- 5 Kontakthülse, Dichteinsatz und Druckmutter bis Mantelende vorschieben.
- 6 Schirmgeflecht (6) oder Schirmfolie über Kontakthülse legen und überstehendes Schirmmaterial abschneiden.
- 7 Kabel durch das bereits montierte Unterteil der Kabelverschraubung führen.
- 8 Dichteinsatz und Kontakthülse bündig in das Unterteil stecken.
- 9 Druckmutter mit dem Unterteil verschrauben, bis der Dichteinsatz zwischen Druckmutter und Kabel einen kleinen Wulst bildet.

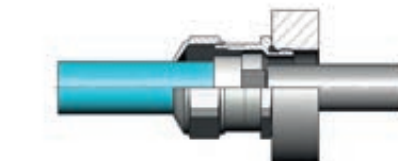
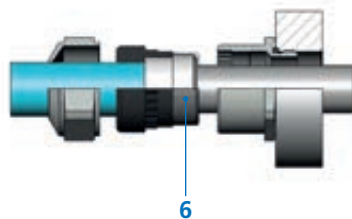
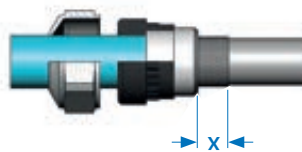
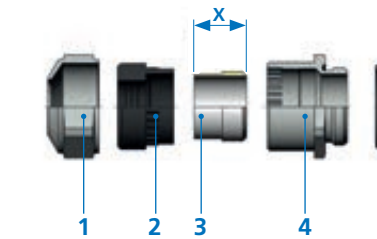

### Progress® EMV

- 1 Screw the lower part (4) of the cable gland into the housing.
- 2 Push compression nut (1), sealing insert (2) and contact bushing (3) over the cable.
- 3 Trim outer sheath of the cable to the desired length.
- 4 Trim braided shield or shielding foil to the approximate length of contact bushing X.
- 5 Push contact bushing, sealing insert and compression nut to the end of the sheath.
- 6 Place braided shield (6) or shielding foil over the contact bushing and cut off the protruding shielding material.
- 7 Feed cable through the already mounted lower part of the cable gland.
- 8 Insert sealing insert and contact bushing flush into the lower part.
- 9 Tighten compression nut to the lower part until the sealing insert forms a small ridge between the compression nut and the cable.

## Progress® EMV Serie 85

1 Den Kabelmantel und Kabelschirm mit einer Schere sauber auf die gewünschte Länge zurückschneiden, wenn der Kabelschirm nicht weiter geführt werden muss.

**Um den Kabelschirm optimal zu schützen, ist es erforderlich, dass der Lieferung beiliegende Kupfer-EMV-Tape (Kupferklebeband 25 mm, Scotch 3M Typ 1181) zu montieren.**

2 Das Unterteil (Pos. 5) der Kabelverschraubung in das vorgesehene Gehäuse einschrauben, Druckmutter (Pos. 1), Dichteinsatz (Pos. 2), Zwischenstück (Pos. 4) und Spannzange (Pos. 3) über das Kabel aufschieben. Kabel mit der Spannzange in das Unterteil einführen und positionieren.

3 Zwischenstück mit dem Unterteil verschrauben, bis das Kabel fühlbar geklemmt wird, anschließend gemäß unten stehender Tabelle festziehen.

4 Druckmutter mit dem Zwischenstück (Zwischenstück mit Schlüssel kontern) verschrauben, bis der Dichteinsatz zwischen Druckmutter und Kabel einen kleinen Wulst bildet.

Die Montage sollte nur durch geschultes Fachpersonal durchgeführt werden.

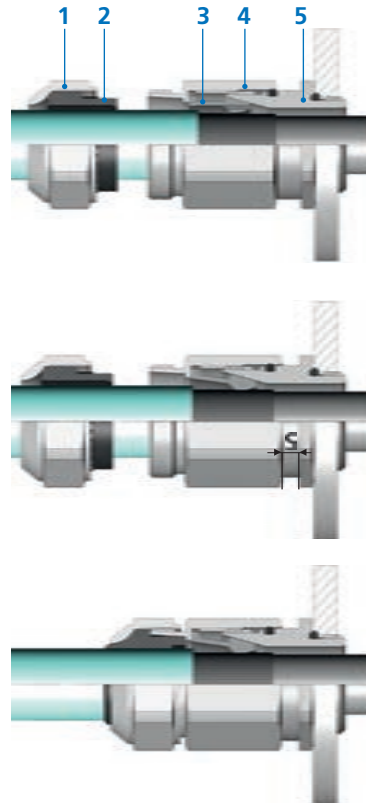

## Progress® EMC Series 85

1 Trim the outer cable sheath and cable shield neatly to the desired length using a cutter if the cable shield need not be continued.

**To provide the best possible protection for the cable shield, it is necessary to install a copper EMC tape (copper adhesive tape 25 mm wide, Scotch 3M type 1181).**

2 Screw the lower section (item 5) of the cable gland into the housing. Push the compression nut (item 1), sealing insert (item 2), adapter (item 4) and collet (item 3) over the cable. Use the collet to introduce and position the cable in the lower section.

3 Screw the adapter onto the lower section until the cable becomes clamped, then tighten according to the table below.

4 Screw the compression nut onto the adapter (tighten the adapter using a spanner) until the sealing insert forms a small ridge between the compression nut and the cable.

Installation should only be carried out by trained experts.

**Das Kupfer-Tape muss zwingend gemäß Illustration montiert werden! Klebeschuttfolie vorgängig entfernen.**

**The copper tape must be fixed according to the illustration! Remove protection film first.**



Tape Scotch 3M Typ 1181



### Hilfstabelle zur optimalen Schirmkontaktierung

Die Angaben dienen als Arbeitshilfe und ermöglichen eine fachgerechte Montage der Kabelverschraubung Progress EMV Serie 85. Die Richtwerte sind unverbindlich.

### Information Table for Optimum Shield Contact

The information is provided as a work instruction and facilitates professional installation of the Progress EMC Series 85 cable gland. The reference values are non-binding.

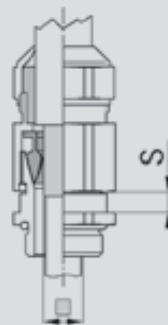

Art-Nr.	Ø Schirm Ø Shield	S mm
1000.17.85.045	3.0 - 4.0	0
	4.0 - 4.5	1.0
1000.17.85.080	4.5 - 6.0	0
	6.0 - 8.0	1.5
1000.17.85.100	7.5 - 10.0	0
1000.20.85.120	7.5 - 10.0	0
	10.0 - 12.0	1.5
1000.20.85.140	10.0 - 12.0	0
	12.0 - 14.0	1.5
1000.25.85.160	10.0 - 13.0	0
	13.0 - 16.0	2.0
1000.25.85.190	14.0 - 16.5	0
	16.5 - 19.0	2.0
1000.32.85.220	14.0 - 18.0	0
	18.0 - 22.0	3.0
1000.32.85.250	21.0 - 23.0	0
	23.0 - 25.0	2.0
1000.40.85.300	21.0 - 25.5	0
	25.5 - 30.0	3.0
1000.50.85.300	29.0 - 33.5	0
	33.5 - 38.0	3.0
1000.63.85.380	29.0 - 33.5	0
	33.5 - 38.0	3.0
1000.63.85.440	35.0 - 39.5	0.5
	39.5 - 44.0	3.0



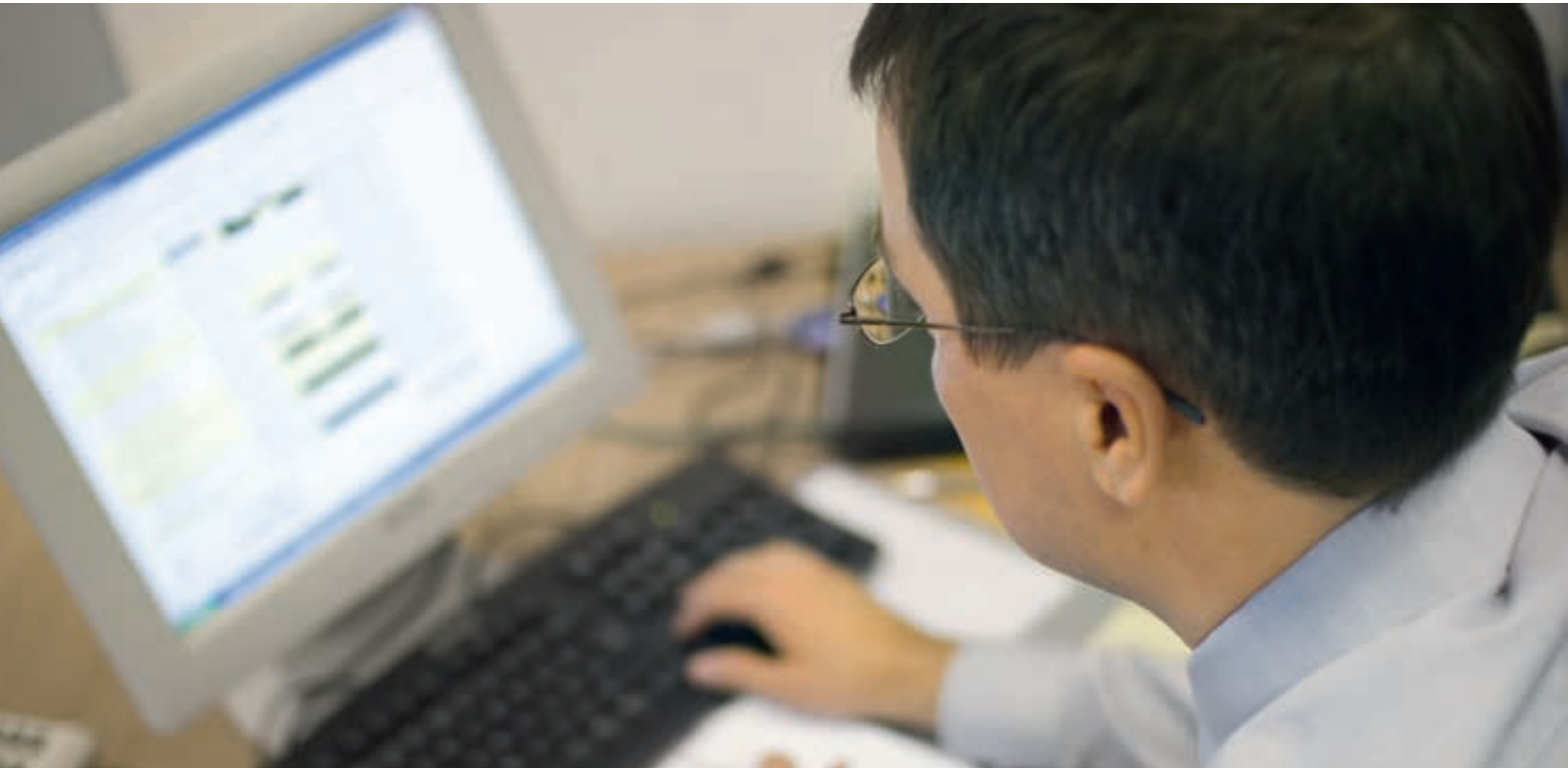

- KAISER online
- Dynamische Produktsuche
- Merkliste
- Produktvergleich
- 3D-Ansicht
- CAD-Download
- Anfragefunktion

- KAISER online
- Dynamic product searching
- Memo list
- Product comparison
- 3D display
- CAD download
- Inquiry function

Auf unserer Website [www.kaiser-elektro.de](http://www.kaiser-elektro.de) bieten wir Ihnen **umfangreiche Informationen**. Dank der **benutzerfreundlichen Navigation** und der **dynamischen Suchfunktionen** finden Sie die zu Ihrer Anwendung passenden Kabelverschraubungen hier in Sekundenschnelle. Die **Produktansicht** zeigt alle technischen Daten sowie Zulassungen auf einen Blick. Aus jeder Produktansicht können Sie ein **Produktdatenblatt im PDF-Format** generieren. Die gewählten Produkte können Sie in einer **Merkliste** speichern, welche eine Vielfalt an Funktionen bietet – z. B. Produktvergleich, Medien-Download oder Anfrageformular. Die **CAD-Daten** zu allen Kabelverschraubungen sind online hinterlegt. Diese können entweder in einer dynamisch generierten **3D-Ansicht** angezeigt werden oder lassen sich in allen gängigen CAD-Formaten an die eigene E-Mail-Adresse senden. Wir freuen uns auf Ihren virtuellen Besuch auf unserer Website!

You can find **comprehensive information** on our [www.kaiser-elektro.de](http://www.kaiser-elektro.de) website. The **user-friendly navigation** and the **dynamic search functions** ensure that you will find the cable glands you need for your application in just a few seconds. The **product overview** shows all the technical information and also technical approvals at a glance. You can generate a **pdf-format product data sheet** from every product overview. In addition, you can store the products you need for your application in a memo list which gives you a wide range of functions, for example product comparisons, media download or an inquiry form. We have put online the **CAD data** on all cable glands. The data can be displayed as a dynamically-generated 3D format or can be sent to an email address in all standard CAD formats. We look forward to your virtual visit to our website!



youtube Kanal deutsch

### Neu: Produkt-Animationen für Ihr Smartphone

Der QR Code ermöglicht Ihnen einen schnellen und bequemen Zugriff auf unsere informativen Produkt-Animationen mit Ihrem Smartphone. Probieren Sie es aus! Über diesen QR Code erhalten Sie den Zugang auf eine Präsentation unseres Kabelverschraubungs-Sortimentes.

### New: Product animations for your smartphone

The QR codes give you fast, easy access to our informative product animations via your smartphone. Try it - you'll like it!

By activating this QR Code, you will get access to the presentation of our assortment of cable glands.









youtube channel English

**1. Ziffer:**

Schutzgrad für Berührungs- und Fremdkörperschutz

**1st figure:**

Degree of protection against touching and foreign matters









IP Prüfungen / Specifications	
<b>IP 0x</b>	<b>Kein Schutz</b> <b>No protection</b>
<b>IP 1x</b> 	Schutz gegen Eindringen von festen Fremdkörpern größer als 50 mm (unbeabsichtigtes Berühren mit der Hand) Protection against penetration by solid foreign matters larger than 50 mm (accidental touching by hand)
<b>IP 2x</b> 	Schutz gegen Eindringen von festen Fremdkörpern größer als 12 mm (unbeabsichtigtes Berühren mit den Fingern) Protection against penetration by solid foreign matters larger than 12 mm (touching with fingers)
<b>IP 3x</b> 	Schutz gegen Eindringen von festen Fremdkörpern größer als 2.5 mm (unbeabsichtigtes Berühren mit Werkzeugen, Drähten usw., dicker als 2.5mm) Protection against penetration by solid foreign matters larger than 2.5 mm (touching with tools, wires etc. larger than 2.5 mm)
<b>IP 4x</b> 	Schutz gegen Eindringen von festen Fremdkörpern größer als 1 mm (Berühren mit Werkzeugen, Drähten usw., dicker als 1 mm) Protection against penetration by solid foreign matters larger than 1 mm (touching with tools, wires etc. larger than 1 mm)
<b>IP 5x</b> 	Vollständiger Schutz gegen Berühren, Schutz gegen schädliche Staubablagerung – Eindringen von Staub wird nicht vollkommen verhindert Complete protection from being touched. Protection from harmful dust deposits - dust penetration is not completely prevented
<b>IP 6x</b> 	Vollständiger Schutz gegen Berühren, Schutz gegen Eindringen von Staub Complete protection from being touched. Protection against penetration by dust..

**2. Ziffer:**

Schutzgrad für Wasserschutz

**2nd figure:**

Degree of protection against water

IP Prüfungen / Specifications	
<b>IP x0</b>	<b>Kein Schutz</b> <b>No protection</b>
<b>IP x1</b> 	Senkrecht fallende Tropfen dürfen keine schädigende Wirkung haben Dripping water (vertically falling drops) shall have no harmful effect
<b>IP x2</b> 	Senkrecht fallende Tropfen dürfen keine schädigende Wirkung haben, wenn das Gehäuse um einen Winkel von bis zu 15° beiderseits der Senkrechten geneigt ist Vertically dripping water shall have no harmful effect when the enclosure is tilted at an angle up to 15° from its normal position
<b>IP x3</b> 	Wasser, das in einem Winkel bis zu 60° beiderseits der Senkrechten gesprüht wird, darf keine schädliche Wirkung haben Water falling as a spray at any angle up to 60° from the vertical shall have no harmful effect
<b>IP x4</b> 	Wasser, das aus jeder Richtung gegen das Gehäuse spritzt, darf keine schädliche Wirkung haben Water splashing against the enclosure from any direction shall have no harmful effect
<b>IP x5</b> 	Wasser, das aus jeder Richtung als Strahl gegen das Gehäuse gerichtet ist, darf keine schädliche Wirkung haben Water projected by a nozzle against enclosure from any direction shall have no harmful effects
<b>IP x6</b> 	Wasser, das aus jeder Richtung als starker Strahl gegen das Gehäuse spritzt, darf keine schädliche Wirkung haben Water projected in powerful jets against the enclosure from any direction shall have no harmful effects
<b>IP x7</b> 	Wasser darf nicht in einer Menge eintreten, die schädliche Wirkungen verursacht, wenn das Gehäuse unter genormten Druck- und Zeitbedingungen zeitweilig in Wasser getaucht ist Ingress of water in harmful quantity shall not be possible when the enclosure is immersed in water under defined conditions of pressure and time
<b>IP x8</b> 	Wasser darf nicht in einer Menge eintreten, die schädliche Wirkungen verursacht, wenn das Gehäuse dauernd unter Wasser getaucht ist unter Bedingungen, die zwischen Hersteller und Anwender vereinbart werden müssen; Die Bedingungen müssen jedoch schwieriger sein als für Kennziffer 7 The equipment is suitable for continuous immersion in water under conditions which shall be specified by the manufacturer The requirements must be more demanding than the ones of code number 7
<b>IP x9K*</b>	Schutz gegen Eindringen von Wasser unter Hochdruck (80-100 bar) mit einer Temperatur bis 80°C (Dampfstrahlreinigung) Protection against the penetration of water during high-pressure (80 - 100 bars), high-temperature wash-down applications (80°C)

\*) IP x9K nach DIN 40050-9  
IP x9K acc. to DIN 40050-9

1  
2  
3  
4  
5  
6  
7  
8  
9  
10  
11  
12

# Materialübersichtstabelle – Metalle

## List of materials – Metals

Produkt Product	Messing vernickelt Nickel-plated brass	Stahl A2 Stainless steel A2	Stahl A4 Stainless steel A4	Aluminium Aluminum
	CuZn39Pb3	X10CrNiS 18 9 DIN 1.4305/AISI 303	X2CrNiMo 18 14 3 DIN 1.4435/AISI 316 L	AlMgSi0.5 DIN 3.3206
<b>Bezeichnung</b>	Kupfer/Zinklegierung Oberfläche galvanisch vernickelt	Rostbeständiger Stahl	Rost- und säurebestän- diger Stahl	Aluminium
<b>Designation</b>	Copper/zinc alloy surface galvanically nickel-plated	Stainless steel	Acid-resistant stainless steel	Aluminum
<b>Korrosionsverhalten Chem. Beständigkeit</b>	Gut beständig in trockener Atmosphäre, Süßwasser, Wasserdampf, Mineralölen, Kraftstoffen, Kühl-/Schmierstoffen und vielen organischen Emulsionen	Gut beständig gegen verdünnte organische und oxidierende Säuren, Laugen, neutrale und alkalische Salzlösungen sowie organische Verbindungen	Hat gute Beständig- keit gegen organische Säuren, z.B. Zitronen-, Milch-, Ameisen-, Wein- und Essigsäure, bei hoher Konzentra- tion und Temperatur. Anorganische Säuren, z.B. Bor-Phosphor- und Salpetersäure sowie schweflige Säure, bei mäßiger Konzentration und Temperatur.	Gut beständig in trockener Atmosphäre, Mineralölen, Kraftstoffen
<b>Corrodibility Chemical resistance</b>	High resistance in dry atmosphere, freshwater, against water vapour, mineral oil, motor fuels, cooling and lubricating liquids and against many other organic emulsions	High resistance against diluted organic and oxidizing acids, alkaline solutions, neutral and alkaline saline solutions, as well as against organic compounds	Good resistance against organic acids such as citric, lactic, formic and ethanoic acid as well as acidity of wine in high concentration and temperatures. Good resistance against inorganic acids such as boron -phosphoric acid, nitric acid and sulphu- rous acids in moderate concentration and tem- perature	High resistance in dry atmosphere. Resistance against most mineral oils and motor fuels
<b>Bedingt bzw. nicht beständig</b>	Meer-, Brackwasser, feuchte Atmosphären, Säuren, Laugen, Chlori- de, Ammoniak	Anorganische Säuren, Halogene, Chloride und chloridhaltige Lösungen oder Atmosphären	Salzsäure, Halogene, Chloride und chlorid- haltige Lösungen oder Atmosphären	Süß-, Meer-, Brackwas- ser, feuchte Atmosphä- ren, Säuren, Laugen
<b>Non- or partial resi- stance only</b>	Seawater, brackwater, humid atmosphere, acids, alkaline solutions, chlorides, ammonia	Inorganic acids, halogen, chlorides and chlorid containing solutions or atmospheres	Hydrochloric acid, halo- gen, chlorides and chlo- rid containing solutions or atmospheres	Freshwater, sea- and brackwater, humid at- mosphere, acids, alkaline solutions
<b>Witterungsbeständig- keit</b>	Sehr gute Witterungs- und Alterungsbestän- digkeit	Sehr gute Witterungs- und Alterungsbestän- digkeit	Sehr gute Witterungs- und Alterungsbestän- digkeit	Gute Witterungs- und Alterungsbeständigkeit
<b>Weather resistance</b>	Very good weather and non-ageing resistance	Very good weather and non-ageing resistance	Very good weather and non-ageing resistance	Good weather and non- ageing resistance
<b>Thermische Werte dauernd Permanent thermal conditions</b>	-40°/+200°	-40°/+400°	-40°/+400°	-40°/+200°
<b>Brennbarkeit Combustibility</b>	Nicht brennbar Non-combustible	Nicht brennbar Non-combustible	Nicht brennbar Non-combustible	Nicht brennbar Non-combustible

Bei speziellen Anwendungen bitten wir um Ihre schriftliche Anfrage.

In case of special applications, we kindly ask you to send us your written request.

Technische Änderungen vorbehalten! | Technical modifications are subject to change!

# Materialübersichtstabelle – Kunststoffe

## List of materials – Elastomeric materials

Produkt / Product Product	Agromid	PA GFK	PA	Polyester
<b>Bezeichnung</b>	Polyamid PA6 GF30, glasfaserverstärkt, schlagzäh, wärmestabilisiert	Polyamid PA6 GF30, glasfaserverstärkt	Polyamid PA6	Polyester PET
<b>Designation</b>	Polyamide PA6 GF30, glass-fiber reinforced, impact resistant, heat-stabilized	Polyamide PA6 GF30, glass-fibre reinforced	Polyamide PA6	Polyester PET
<b>Farbe</b> <b>Colour</b> <b>Couleur</b>	Nach Katalog See catalogue	Nach Katalog See catalogue	Nach Katalog See catalogue	Nach Katalog See catalogue
<b>Korrosionsverhalten</b> <b>Chem. Beständigkeit</b>	Beständig gegen verdünnte organische Säuren, Laugen, wässrige Lösungen von anorganischen Salzen, Mineralöle, Kraftstoffe, Kühl- und Schneideöle			gute Beständigkeit gegen Wasser (bei Raumtemperatur), verdünnte Säuren, neutrale und saure Salze, Alkohol, Ether, Öle, Fette, perchlorierte und aromatische Kohlenwasserstoffe
<b>Corrodibility</b> <b>Chemical resistance</b>	Resistant against organic diluted acids, alkaline solutions, diluted inorganic saline solutions, mineral oils, motor fuels, cooling and cutting oils			good resistance to water (room temperature), diluted acids, neutral and acid salts, alcohol, ether, oils, greases, perchlorinated and aromatic hydrocarbons
<b>Bedingt bzw. nicht beständig</b>	Mineralsäuren, konzentrierte organische Säuren, Ameisensäure, Phenole, Halogene			Alkalien, überhitzten Dampf, Ketone, Phenole, Ester, oxidierende Säuren und Kohlenwasserstoffe, Ammoniak
<b>Non- or partial resistance only</b>	Mineral acids, concentrated organic acids, formic acids, phenols, halogens			Alkalins, superheated steam, ketones, phenols, esters, oxidising acids and hydrocarbons, ammonia
<b>Witterungsbeständigkeit</b> <b>Weather resistance</b>	Gut witterungs- und alterungsbeständig Good weather and non-ageing resistance	Gut witterungsbeständig Good weather resistance	Gut witterungsbeständig Good weather resistance	Gut witterungsbeständig Good weather resistance
<b>Thermische Werte dauernd</b> <b>Permanent thermal conditions</b>	-30°/+120°C	-20°/+100°C	-30°/+100°C	-50°C/+150°C
<b>Brennbarkeit</b> <b>Combustibility</b>	vergleichbar UL 94 HB halogenfrei comparable UL 94 HB halogen free	vergleichbar UL 94 HB halogenfrei comparable UL 94 HB halogen free	UL 94 V-2 halogenfrei UL 94 V-2 halogen free	EN 45545-2 (HL3) halogenfrei EN 45545-2 (HL3) halogen free

Bei speziellen Anwendungen bitten wir um Ihre schriftliche Anfrage.  
In case of special applications, we kindly ask you to send us your written request.

# Materialübersichtstabelle – Elastomere

## List of materials – Elastomeric materials

Produkt / Product	TPE	Spezial/Special TPE	NBR	FPM
<b>Bezeichnung</b>	Thermoplastisches Elastomer	Thermoplastisches Elastomer, Spezial Compound	Acrylnitril-Butadien-Kautschuk	Fluor-Kautschuk
<b>Designation</b>	Thermoplastic elastomere	Thermoplastic elastomere, special compound	Acrylonitrile-butadiene caoutchouc	Fluorine-caoutchouc
<b>Farbe</b> <b>Colour</b>	Schwarz Black	Hellgrau RAL 7035 Light grey RAL 7035	Schwarz BlackBlack	Grün Green
<b>Korrosionsverhalten</b> <b>Chem. Beständigkeit</b>	Beständig gegen verdünnte Säuren und Laugen, wässrige Lösungen von anorganischen Salzen	Gut beständig gegen wässrige Lösungen von anorganischen Salzen, verdünnte Säuren und Laugen, Heißwasser sowie Meerwasser.	Beständig gegen verdünnte Säuren und Laugen, wässrige Lösungen von anorganischen Salzen, Mineralöle, Kraftstoffe, Kühl- und Schneideöle	Beständig gegen die meisten Säuren und Laugen, wässrige Lösungen von anorganischen Salzen, Mineralöle, Kraftstoffe, Kühl- und Schneideöle
<b>Corrodibility</b> <b>Chemical resistance</b>	Resistant against diluted acids and alkaline solutions, against diluted inorganic saline solutions	High resistance against diluted inorganic saline solutions, against diluted acids and alkaline solutions, hotwater as well as seawater.	Resistant against diluted acids and alkaline solutions, against diluted inorganic saline solutions, mineral oils, motor fuels, cooling and cutting oils	Resistant against most acids and alkaline solutions, against diluted inorganic saline solutions, mineral oils, motor fuels, cooling and cutting oils
<b>Bedingt bzw. nicht beständig</b>	Konzentrierte Säuren und Laugen, Lösungsmittel, Kraftstoffe, Mineral-, Kühle- und Schneideöle	Nicht beständig gegen Kraftstoffe, Lösungsmittel, konzentrierte Säuren und Laugen.	Konzentrierte Säuren und Laugen, Lösungsmittel, Ozon	Konzentrierte Laugen
<b>Non- or partial resistance only</b>	Concentrated acids and alkaline solutions, solvents, motor fuels, mineral, cooling and cutting oils	Non resistant to motor fuels, solvents, concentrated acids and alkaline solutions.	Concentrated acids and alkaline solutions, solvents, ozone	Concentrated alkaline solutions
<b>Witterungsbeständigkeit</b>	Gut witterungs-, ozon- und alterungsbeständig	Gut witterungs-, ozon- und alterungsbeständig	Gut witterungsbeständig	Sehr gut witterungs-, ozon- und alterungsbeständig
<b>Weather resistance</b>	Good weather-, ozone and non-ageing resistance	Good weather-, ozone and non-ageing resistance	Good weather resistance	Very good weather-, ozone and non-ageing resistance
<b>Thermische Werte dauernd</b> <b>Permanent thermal conditions</b>	-40°/+100°	-50°C/+105°C	-40°/+100°	-40°/+200°
<b>Brennbarkeit</b>	vergleichbar UL 94 HB halogenfrei	EN 45545-2 / HL3 EN 45545-3 / E30	vergleichbar UL94 HB halogenfrei	vergleichbar UL94 V-2
<b>Combustibility</b>	comparable UL 94 HB halogenfree	EN 45545-2 / HL3 EN 45545-3 / E30	comparable UL 94 HB halogenfree	comparable UL 94 V-2

Bei speziellen Anwendungen bitten wir um Ihre schriftliche Anfrage.  
In case of special applications, we kindly ask you to send us your written request.

Produkt / Product	FKM	EPDM	CR
<b>Bezeichnung</b> <b>Designation</b>	Fluor-Kautschuk Fluorine-caoutchouc	Ethylen-Propylen-Terpolymere-Kautschuk Ethylene-Propylene-diene rubber	Chloropren-Kautschuk Chloroprene-caoutchouc
<b>Farbe</b> <b>Colour</b>	blau blue	Nach Katalog See catalogueSee catalogue	Schwarz BlackBlack
<b>Korrosionsverhalten</b> <b>Chem. Beständigkeit</b>	Beständig gegen die meisten Säuren und Laugen, wässrige Lösungen von anorganischen Salzen, Mineralöle, Kraftstoffe, Kühl- und Schneideöle FDA konform	Heißwasser, wässrige Lösungen von anorganischen Salzen, verdünnte Säuren und Laugen	Beständig gegen verdünnte Säuren und Laugen, wässrige Lösungen von anorganischen Salzen, Mineralöle, Kühl- und Schneideöle
<b>Corrodibility</b> <b>Chemical resistance</b>	Resistant against most acids and alkaline solutions, against diluted inorganic saline solutions, mineral oils, motor fuels, cooling and cutting oils. In conformity with FDA requirements.	Hot water, diluted inorganic solutions, diluted acids and alkaline solutions	Resistant against diluted acids and alkaline solutions, against diluted inorganic saline solutions, mineral oils, cooling and cutting oils
<b>Bedingt bzw. nicht beständig</b> <b>Non- or partial resistance only</b>	Konzentrierte Laugen Concentrated alkaline solutions	Mineralöle, Kraft- und Treibstoffe, konzentrierte Säuren und Laugen, Ester Mineral oils, motor fuels, concentrated acids and alkaline solutions, ester	Konzentrierte Säuren und Laugen, Kraftstoffe, Lösungsmittel, Heißwasser, Ozon Concentrated acids and alkaline solutions, motor fuels, solvents, hotwater, ozone
<b>Witterungsbeständigkeit</b> <b>Weather resistance</b>	Sehr gut witterungs-, ozon- und alterungsbeständig Very good weather-, ozone and non-ageing resistance	Gut witterungs-, ozon- und alterungsbeständig Good weather, ozone and non-ageing resistance	Gut witterungsbeständig Good weather resistance
<b>Thermische Werte dauernd</b> <b>Permanent thermal conditions</b>	-40°C/+200°C	-40°/+110°C	-30°/+100°
<b>Brennbarkeit</b> <b>Combustibility</b>	vergleichbar UL94 V-2 comparable UL 94 V-2	vergleichbar UL 94 HB halogenfrei comparable UL 94 HB halogen free	vergleichbar UL94 HB comparable UL 94 HB

Bei speziellen Anwendungen bitten wir um Ihre schriftliche Anfrage.  
 In case of special applications, we kindly ask you to send us your written request.



# Maße für Gewinde und Bohrlöcher

## Dimensions of threads and drilled holes

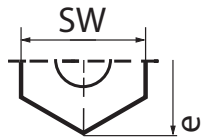



### Ermittlung der Eckmaße „e“

6-Kant:  
 $e = 1.155 \times SW$  (Schlüsselweite)

### Determinatin of the width across corners „e“

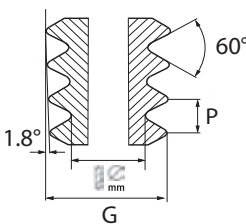
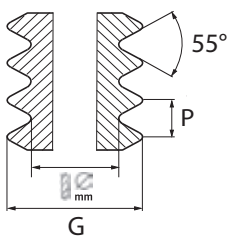
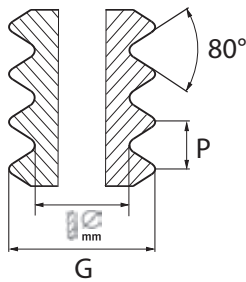
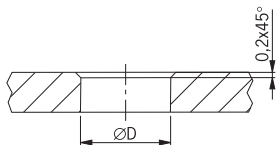
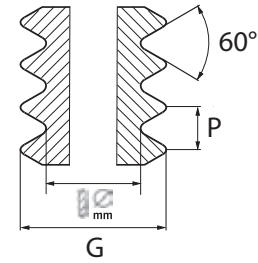
hexagon:  
 $e = 1.155 \times SW$  (opening of the spanner)



	G	Steigung   Pitch P	 mm	ØD mm
<b>Metrisches Gewinde   Metric thread</b>				
M6x1.0 <sup>1)</sup>	6.00	1.00	5.00	6.0
M6x0.75 <sup>2)</sup>	6.00	0.75	5.25	6.0
M8x1.25 <sup>1)</sup>	8.00	1.25	6.75	8.0
M8x1.0 <sup>2)</sup>	8.00	1.00	7.00	8.0
M10x1.5 <sup>1)</sup>	10.00	1.50	8.50	10.0
M10x1.0 <sup>2)</sup>	10.00	1.00	9.00	10.0
M12x1.5	12.00	1.50	10.50	12.0
M16x1.5	16.00	1.50	14.50	16.0
M20x1.5	20.00	1.50	18.50	20.0
M25x1.5	25.00	1.50	23.50	25.0
M32x1.5	32.00	1.50	30.50	32.0
M40x1.5	40.00	1.50	38.50	40.2
M50x1.5	50.00	1.50	48.50	50.2
M63x1.5	63.00	1.50	61.50	63.2
M75x1.5	75.00	1.50	73.50	75.2
M80x1.5	80.00	1.50	78.50	80.2
M85x2.0	85.00	2.00	83.00	85.2
M95x2.0	95.00	2.00	93.00	95.2
M100x3.0	100.00	3.00	97.00	100.2
M105x3.0	105.00	3.00	102.00	105.2
M115x3.0	115.00	3.00	112.00	115.2
<b>Pg - Gewinde   Thread Pg</b>				
Pg 7	12.50	1.27	11.40	12.6
Pg 9	15.20	1.41	14.00	15.3
Pg 11	18.60	1.41	17.25	18.7
Pg 13	20.40	1.41	19.00	20.5
Pg 16	22.50	1.41	21.25	22.6
Pg 21	28.30	1.58	26.75	28.4
Pg 29	37.00	1.58	35.50	37.2
Pg 36	47.00	1.58	45.50	47.2
Pg 42	54.00	1.58	52.50	54.2
Pg 48	59.30	1.58	57.80	59.5
<b>Gasrohr-Gewinde   Gas-pipe thread</b>				
G 1/4"	13.15	1.33	11.60	13.3
G 3/8"	16.66	1.33	15.00	16.8
G 1/2"	20.95	1.81	19.00	21.0
G 5/8"	22.91	1.81	21.00	23.0
G 3/4"	26.44	1.81	24.60	26.5
G 1"	33.25	2.30	30.50	33.5
G 1 1/4"	41.91	2.30	39.50	42.2
G 1 1/2"	47.80	2.30	45.00	48.0
G 2"	59.61	2.30	57.00	60.0
G 2 1/2"	75.18	2.30	72.50	75.5
G 3"	87.88	2.30	84.50	88.0
G 4"	113.03	2.30	110.50	113.5
G 5"	138.43	2.30	136.00	139.0
<b>NPT-Gewinde   Filetage NPT</b>				
NPT 1/8"	10.29	0.94	8.43	
NPT 1/7"	13.72	1.41	11.13	
NPT 3/8"	17.14	1.41	14.27	
NPT 1/2"	21.34	1.81	17.86	
NPT 3/4"	26.67	1.81	23.28	
NPT 1"	33.40	2.20	28.98	
NPT 1 1/4"	42.16	2.20	37.69	
NPT 1 1/2"	48.26	2.20	43.66	
NPT 2"	60.32	2.20	55.58	

1) Metrisches Regelgewinde  
 2) Metrisches Gewinde nach EN60423

1) metric coarse pitch thread  
 2) metric thread acc. to EN 60423

Art.-Nr. Art. No.	Seite Page	Art.-Nr. Art. No.	Seite Page	Art.-Nr. Art. No.	Seite Page	Art.-Nr. Art. No.	Seite Page	Art.-Nr. Art. No.	Seite Page
<b>10...</b>		1000.100.850	17	1000.17	18	1000.29.190	23	1000.40.285	17
1000.06.025	17	1000.105.30.03	225	1000.17.045	17	1000.29.230	23	1000.40.30	38
1000.06.030	17	1000.105.900	17	1000.17.060	17	1000.29.275	23	1000.40.30.03	225
1000.06.035	17	1000.11	24	1000.17.080	17	1000.29.30	38	1000.40.30.91	39
1000.06.30	38	1000.11.055	23	1000.17.105	17	1000.29.30.03	225	1000.40.330	17
1000.06.30.03	225	1000.11.085	23	1000.17.30	38	1000.29.30.91	39	1000.40.85.300	100
1000.06.30.91	39	1000.11.120	23	1000.17.30.03	225	1000.29.40.30	38	1000.40.91.330	30
1000.06.91.025	30	1000.11.20.30	38	1000.17.30.91	39	1000.29.40.30.91	39	1000.40.92	30
1000.06.91.030	30	1000.11.20.30.91	39	1000.17.85.045	100	1000.29.85.220	101	1000.40.98.30.03	225
1000.06.91.035	30	1000.11.30	38	1000.17.85.080	100	1000.29.85.250	101	1000.42	24
1000.06.98.30.03	225	1000.11.30.03	225	1000.17.85.100	100	1000.29.91.275	32	1000.42.00.08	226
1000.07.050	23	1000.11.30.91	39	1000.17.91.105	30	1000.29.92	32	1000.42.30	38
1000.07.065	23	1000.11.85.080	101	1000.17.92	30	1000.29.98.30.03	225	1000.42.30.91	39
1000.07.080	23	1000.11.85.120	101	1000.17.98.30.03	225	1000.2G	29	1000.42.330	23
1000.07.30	38	1000.11.91.120	32	1000.1G	29	1000.2NPT	28	1000.42.370	23
1000.07.30.91	39	1000.11.92	32	1000.1NPT	28	1000.2NPT.400	28	1000.42.420	23
1000.07.91.050	32	1000.11.98.30.03	225	1000.1NPT.170	28	1000.2NPT.460	28	1000.42.91.420	32
1000.07.91.065	32	1000.11/2G	29	1000.1NPT.210	28	1000.2NPT.520	28	1000.42.92	32
1000.07.91.080	32	1000.11/2NPT	28	1000.1NPT.255	28	1000.3/4G	29	1000.48	24
1000.08.035	17	1000.11/2NPT.330	28	1000.20	18	1000.3/4NPT	28	1000.48.00.08	226
1000.08.050	17	1000.11/2NPT.370	28	1000.20.080	17	1000.3/4NPT.125	28	1000.48.30	38
1000.08.30	38	1000.11/2NPT.410	28	1000.20.110	17	1000.3/4NPT.160	28	1000.48.30.03	225
1000.08.30.03	225	1000.11/4NPT	28	1000.20.150	17	1000.3/4NPT.205	28	1000.48.30.91	39
1000.08.30.91	39	1000.11/4NPT.240	28	1000.20.30	38	1000.3/8G	29	1000.48.370	23
1000.08.91.035	30	1000.11/4NPT.285	28	1000.20.30.03	225	1000.3/8NPT	28	1000.48.430	23
1000.08.91.050	30	1000.11/4NPT.330	28	1000.20.30.91	39	1000.3/8NPT.045	28	1000.48.490	23
1000.08.98.30.03	225	1000.115.30.03	225	1000.20.85.120	100	1000.3/8NPT.060	28	1000.48.91.490	32
1000.085.30.03	225	1000.115.950	17	1000.20.85.140	100	1000.3/8NPT.080	28	1000.48.92	32
1000.09	24	1000.12.050	17	1000.20.91.150	30	1000.3/8NPT.105	28	1000.48.98.30.03	225
1000.09.00.08	226	1000.12.065	17	1000.20.92	30	1000.32	18	1000.50	18
1000.09.045	23	1000.12.080	17	1000.20.98.30.03	225	1000.32.170	17	1000.50.00.08	226
1000.09.060	23	1000.12.30	38	1000.21	24	1000.32.210	17	1000.50.30	38
1000.09.080	23	1000.12.30.03	225	1000.21.125	23	1000.32.255	17	1000.50.30.03	225
1000.09.105	23	1000.12.30.91	39	1000.21.160	23	1000.32.30	38	1000.50.30.91	39
1000.09.30	38	1000.12.91.050	30	1000.21.205	23	1000.32.30.03	225	1000.50.330	17
1000.09.30.91	39	1000.12.91.065	30	1000.21.30	38	1000.32.30.91	39	1000.50.370	17
1000.09.91.105	32	1000.12.91.080	30	1000.21.30.91	39	1000.32.85.220	100	1000.50.420	17
1000.09.92	32	1000.12.98.30.03	225	1000.21.32.30	38	1000.32.85.250	100	1000.50.85.380	100
1000.095.30.03	225	1000.13	24	1000.21.32.30.91	39	1000.32.91.255	30	1000.50.91.420	30
1000.1/2G	29	1000.13.080	23	1000.21.85.160	101	1000.32.92	30	1000.50.92	30
1000.1/2NPT	28	1000.13.110	23	1000.21.85.190	101	1000.32.98.30.03	225	1000.50.98.30.03	225
1000.1/2NPT.080	28	1000.13.150	23	1000.21.91.205	32	1000.36	24	1000.63	18
1000.1/2NPT.110	28	1000.13.30	38	1000.21.92	32	1000.36.260	23	1000.63.00.08	226
1000.1/2NPT.150	28	1000.13.30.91	39	1000.21/2G.500	29	1000.36.30	38	1000.63.30	38
1000.1/4NPT.050	28	1000.13.91.150	32	1000.21/2G.560	29	1000.36.30.03	225	1000.63.30.03	225
1000.1/4NPT.065	28	1000.13.92	32	1000.25	18	1000.36.30.91	39	1000.63.30.91	39
1000.1/4NPT.080	28	1000.16	24	1000.25.125	17	1000.36.305	23	1000.63.400	17
1000.1/8NPT.040	28	1000.16.080	23	1000.25.160	17	1000.36.350	23	1000.63.460	17
1000.1/8NPT.060	28	1000.16.110	23	1000.25.205	17	1000.36.50.30	38	1000.63.520	17
1000.10.040	17	1000.16.150	23	1000.25.30	38	1000.36.50.30.91	39	1000.63.85.380	100
1000.10.060	17	1000.16.25.30	38	1000.25.30.03	225	1000.36.91.350	32	1000.63.85.440	100
1000.10.30	38	1000.16.25.30.91	39	1000.25.30.91	39	1000.36.92	32	1000.63.91.520	30
1000.10.30.03	225	1000.16.30	38	1000.25.85.160	100	1000.36.98.30.03	225	1000.63.92	30
1000.10.30.91	39	1000.16.30.91	39	1000.25.85.190	100	1000.3G.630	29	1000.63.98.30.03	225
1000.10.91.040	30	1000.16.85.120	101	1000.25.91.205	30	1000.3G.700	29	1000.75	18
1000.10.91.060	30	1000.16.85.150	101	1000.25.92	30	1000.40	18	1000.75.00.08	226
1000.10.98.30.03	225	1000.16.91.150	32	1000.25.98.30.03	225	1000.40.00.08	226	1000.75.30.03	225
1000.100.30.03	225	1000.16.92	32	1000.29	24	1000.40.240	17	1000.75.500	17

Art.-Nr. Art. No.	Seite Page	Art.-Nr. Art. No.	Seite Page	Art.-Nr. Art. No.	Seite Page	Art.-Nr. Art. No.	Seite Page	Art.-Nr. Art. No.	Seite Page
1000.75.560	17	1021.80.10	103	1045.13.130	179	1060.11	22	1060.25.52	46
1000.75.630	17	1025.00.16	227	1045.16.080	179	1060.11.055	22	1060.25.52.125	46
1000.85.700	17	1025.00.19	229	1045.16.110	179	1060.11.085	22	1060.25.52.160	46
1000.95.750	17	1025.45.16	228	1045.16.130	179	1060.11.120	22	1060.25.52.190	46
1000.95.800	17	1025.52	45	1045.16.170	179	1060.11.52	47	1060.29	22
1005.00.08	226	1025.80.10	103	1045.17.060	178	1060.11.52.060	47	1060.29.230	22
1006.00.08	226	1029.00.08	226	1045.17.100	178	1060.11.52.080	47	1060.29.275	22
1006.00.16	227	1029.00.16	227	1045.20.080	178	1060.11.52.105	47	1060.32	16
1006.06.08	226	1029.00.19	229	1045.20.130	178	1060.12.050	16	1060.32.210	16
1007.00.08	226	1029.45.16	228	1045.21.150	179	1060.12.065	16	1060.32.255	16
1007.00.16	227	1029.80.10	103	1045.21.210	179	1060.12.075	16	1060.32.52	46
1007.45.16	228	1032.00.16	227	1045.25.110	178	1060.12.52.050	46	1060.32.52.210	46
1007.52	45	1032.00.19	229	1045.25.170	178	1060.12.52.065	46	1060.32.52.245	46
1007.80.10	103	1032.45.16	228	1045.29.230	179	1060.12.52.075	46	1060.36	22
1008.00.16	227	1032.80.10	103	1045.29.280	179	1060.13	22	1060.36.305	22
1008.52	45	1036.00.08	226	1045.32.150	178	1060.13.080	22	1060.36.350	22
1009.00.16	227	1036.00.16	227	1045.32.210	178	1060.13.110	22	1060.40	16
1009.45.16	228	1036.00.19	229	1045.36.290	179	1060.13.145	22	1060.40.285	16
1009.52	45	1036.45.16	228	1045.36.350	179	1060.13.52	47	1060.40.330	16
1009.80.10	103	1036.80.10	103	1045.40.230	178	1060.13.52.080	47	1060.42	22
1010.00.16	227	1040.00.16	227	1045.40.280	178	1060.13.52.110	47	1060.42.370	22
1010.52	45	1040.00.19	229	1045.42.290	179	1060.13.52.145	47	1060.42.420	22
1011.00.08	226	1040.17.40.065	68	1045.42.350	179	1060.16	22	1060.48	22
1011.00.16	227	1040.17.40.080	68	1045.48.390	179	1060.16.080	22	1060.48.430	22
1011.00.19	229	1040.17.96.30.065	69	1045.48.480	179	1060.16.110	22	1060.48.490	22
1011.45.16	228	1040.17.96.30.080	69	1045.50.290	178	1060.16.145	22	1060.50	16
1011.52	45	1040.17.96.70.065	69	1045.50.350	178	1060.16.52	47	1060.50.370	16
1011.80.10	103	1040.17.96.70.080	69	1045.63.390	178	1060.16.52.080	47	1060.50.420	16
1012.00.16	227	1040.20.40.080	68	1045.63.480	178	1060.16.52.110	47	1060.63	16
1012.00.19	229	1040.20.40.105	68	1048.00.16	227	1060.16.52.145	47	1060.63.460	16
1012.45.16	228	1040.20.96.30.080	69	1050.00.16	227	1060.17	16	1060.63.520	16
1012.52	45	1040.20.96.30.105	69	1050.00.19	229	1060.17.060	16	1060.75	16
1013.00.16	227	1040.20.96.70.080	69	1050.45.16	228	1060.17.080	16	1060.75.560	16
1013.00.22.08	226	1040.20.96.70.105	69	1050.80.10	103	1060.17.105	16	1060.75.630	16
1013.45.16	228	1040.25.40.110	68	1060.06.025	16	1060.17.52	46	1063.00.16	227
1013.51	45	1040.25.40.150	68	1060.06.030	16	1060.17.52.060	46	1063.00.19	229
1013.52	45	1040.25.96.30.110	69	1060.07.050	22	1060.17.52.080	46	1063.45.16	228
1016.00.08	226	1040.25.96.30.150	69	1060.07.065	22	1060.17.52.105	46	1063.80.10	103
1016.00.16	227	1040.25.96.70.110	69	1060.07.075	22	1060.20	16	1080.07.060	94
1016.00.25.08	226	1040.25.96.70.150	69	1060.07.52.050	47	1060.20.080	16	1080.07.075	94
1016.45.16	228	1040.32.40.160	68	1060.07.52.065	47	1060.20.110	16	1080.07.52.060	99
1016.51	45	1040.32.40.205	68	1060.07.52.075	47	1060.20.145	16	1080.07.52.075	99
1016.52	45	1040.32.96.30.160	69	1060.08.030	16	1060.20.52	46	1080.08.035	92
1016.80.10	103	1040.32.96.30.205	69	1060.08.040	16	1060.20.52.080	46	1080.08.040	92
1017.00.16	227	1040.32.96.70.160	69	1060.08.52.030	46	1060.20.52.110	46	1080.08.52.035	98
1017.00.19	229	1040.32.96.70.205	69	1060.08.52.040	46	1060.20.52.145	46	1080.08.52.040	98
1017.45.16	228	1040.45.16	228	1060.09	22	1060.21	22	1080.09.080	94
1017.52	45	1040.80.10	103	1060.09.060	22	1060.21.125	22	1080.09.100	94
1017.80.10	103	1042.00.16	227	1060.09.080	22	1060.21.160	22	1080.09.52.080	99
1020.00.19	229	1045.07.050	179	1060.09.105	22	1060.21.190	22	1080.09.52.100	99
1020.45.16	228	1045.07.070	179	1060.09.52	47	1060.21.52	47	1080.09.91.080	97
1020.51	45	1045.09.060	179	1060.09.52.060	47	1060.21.52.125	47	1080.09.91.100	97
1020.52	45	1045.09.100	179	1060.09.52.080	47	1060.21.52.160	47	1080.10.040	92
1020.80.10	103	1045.11.080	179	1060.09.52.105	47	1060.21.52.190	47	1080.10.060	92
1021.00.16	227	1045.11.130	179	1060.10.040	16	1060.25	16	1080.10.52.040	98
1021.00.30.08	226	1045.12.050	178	1060.10.060	16	1060.25.125	16	1080.10.52.060	98
1021.45.16	228	1045.12.070	178	1060.10.52.040	46	1060.25.160	16	1080.10.91.040	96
1021.51	45	1045.13.080	179	1060.10.52.060	46	1060.25.190	16	1080.10.91.060	96

Art.-Nr. Art. No.	Seite Page	Art.-Nr. Art. No.	Seite Page	Art.-Nr. Art. No.	Seite Page	Art.-Nr. Art. No.	Seite Page	Art.-Nr. Art. No.	Seite Page
1080.11.085	94	1080.36.305	94	1100.07.91.080	33	1100.12.065	20	1100.20.50	43
1080.11.120	94	1080.36.350	94	1100.07.94.050	61	1100.12.080	20	1100.20.91.150	31
1080.11.52.080	99	1080.40.285	92	1100.07.94.065	61	1100.12.91.050	31	1100.20.92	31
1080.11.52.100	99	1080.40.320	92	1100.07.94.080	61	1100.12.91.065	31	1100.20.94	60
1080.11.91.085	97	1080.42.370	94	1100.07.96.050	63	1100.12.91.080	31	1100.20.94.150	60
1080.11.91.120	97	1080.42.410	94	1100.07.96.065	63	1100.12.94.050	60	1100.20.96	62
1080.12.060	92	1080.48.430	94	1100.07.96.080	63	1100.12.94.065	60	1100.20.96.150	62
1080.12.075	92	1080.48.465	94	1100.07.98.050	65	1100.12.94.080	60	1100.20.98	64
1080.12.52.060	98	1080.50.370	92	1100.07.98.065	65	1100.12.96.050	62	1100.20.98.150	64
1080.12.52.075	98	1080.50.410	92	1100.07.98.080	65	1100.12.96.065	62	1100.21	27
1080.12.91.060	96	1080.63.460	92	1100.08.035	20	1100.12.96.080	62	1100.21.125	26
1080.12.91.075	96	1080.63.500	92	1100.08.050	20	1100.12.98.050	64	1100.21.160	26
1080.13.110	94	1080.75.560	92	1100.08.91.035	31	1100.12.98.065	64	1100.21.205	26
1080.13.140	94	1080.80.650	92	1100.08.91.050	31	1100.12.98.080	64	1100.21.50	43
1080.13.52.110	99	1080.85.700	92	1100.08.94.035	60	1100.13	27	1100.21.91.205	33
1080.13.52.140	99	1080.95.750	92	1100.08.94.050	60	1100.13.080	26	1100.21.92	33
1080.13.91.110	97	1081.07.060	91	1100.08.96.035	62	1100.13.110	26	1100.21.94	61
1080.13.91.140	97	1081.07.075	91	1100.08.96.050	62	1100.13.150	26	1100.21.94.205	61
1080.16.110	94	1081.09.080	91	1100.08.98.035	64	1100.13.50	43	1100.21.96	63
1080.16.140	94	1081.09.100	91	1100.08.98.050	64	1100.13.91.150	33	1100.21.96.205	63
1080.16.52.110	99	1081.11.085	91	1100.09	27	1100.13.92	33	1100.21.98	65
1080.16.52.140	99	1081.11.120	91	1100.09.045	26	1100.13.94	61	1100.21.98.205	65
1080.16.91.110	97	1081.12.060	90	1100.09.060	26	1100.13.94.150	61	1100.25	21
1080.16.91.140	97	1081.12.075	90	1100.09.080	26	1100.13.96	63	1100.25.125	20
1080.17.080	92	1081.13.110	91	1100.09.105	26	1100.13.96.150	63	1100.25.160	20
1080.17.100	92	1081.13.140	91	1100.09.91.105	33	1100.13.98	65	1100.25.205	20
1080.17.52.080	98	1081.16.110	91	1100.09.92	33	1100.13.98.150	65	1100.25.50	43
1080.17.52.100	98	1081.16.140	91	1100.09.94	61	1100.16	27	1100.25.91.205	31
1080.17.91.080	96	1081.17.080	90	1100.09.94.105	61	1100.16.080	26	1100.25.92	31
1080.17.91.100	96	1081.17.100	90	1100.09.96	63	1100.16.110	26	1100.25.94	60
1080.20.110	92	1081.20.110	90	1100.09.96.105	63	1100.16.150	26	1100.25.94.205	60
1080.20.140	92	1081.20.140	90	1100.09.98	65	1100.16.50	43	1100.25.96	62
1080.20.52.110	98	1081.21.160	91	1100.09.98.08	226	1100.16.91.150	33	1100.25.96.205	62
1080.20.52.140	98	1081.21.190	91	1100.09.98.105	65	1100.16.92	33	1100.25.98	64
1080.20.91.110	96	1081.25.160	90	1100.10.040	20	1100.16.94	61	1100.25.98.205	64
1080.20.91.140	96	1081.25.190	90	1100.10.060	20	1100.16.94.150	61	1100.29	27
1080.21.160	94	1081.29.230	91	1100.10.91.040	31	1100.16.96	63	1100.29.190	26
1080.21.190	94	1081.29.255	91	1100.10.91.060	31	1100.16.96.150	63	1100.29.230	26
1080.21.52.160	99	1081.32.210	90	1100.10.94.040	60	1100.16.98	65	1100.29.275	26
1080.21.52.190	99	1081.32.250	90	1100.10.94.060	60	1100.16.98.150	65	1100.29.50	43
1080.21.91.160	97	1083.12.050	89	1100.10.96.040	62	1100.17	21	1100.29.91.275	33
1080.21.91.190	97	1083.12.065	89	1100.10.96.060	62	1100.17.045	20	1100.29.92	33
1080.25.160	92	1083.17	89	1100.10.98.040	64	1100.17.060	20	1100.29.94	61
1080.25.190	92	1083.20	89	1100.10.98.060	64	1100.17.080	20	1100.29.94.275	61
1080.25.52.160	98	1083.25	89	1100.11	27	1100.17.105	20	1100.29.96	63
1080.25.52.190	98	1083.32	89	1100.11.055	26	1100.17.50	43	1100.29.96.275	63
1080.25.91.160	96	<b>11...</b>		1100.11.085	26	1100.17.91.105	31	1100.29.98	65
1080.25.91.190	96	1100.06.025	20	1100.11.120	26	1100.17.92	31	1100.29.98.275	65
1080.29.230	94	1100.06.030	20	1100.11.50	43	1100.17.94	60	1100.32	21
1080.29.255	94	1100.06.035	20	1100.11.91.120	33	1100.17.94.105	60	1100.32.170	20
1080.29.91.230	97	1100.06.91.025	31	1100.11.92	33	1100.17.96	62	1100.32.210	20
1080.29.91.255	97	1100.06.91.030	31	1100.11.94	61	1100.17.96.105	62	1100.32.255	20
1080.32.210	92	1100.06.91.035	31	1100.11.94.120	61	1100.17.98	64	1100.32.50	43
1080.32.250	92	1100.07.050	26	1100.11.96	63	1100.17.98.105	64	1100.32.91.255	31
1080.32.52.210	98	1100.07.065	26	1100.11.96.120	63	1100.20	21	1100.32.92	31
1080.32.52.245	98	1100.07.080	26	1100.11.98	65	1100.20.080	20	1100.32.94	60
1080.32.91.210	96	1100.07.91.050	33	1100.11.98.120	65	1100.20.110	20	1100.32.94.255	60
1080.32.91.250	96	1100.07.91.065	33	1100.12.050	20	1100.20.150	20	1100.32.96	62

Art.-Nr. Art. No.	Seite Page	Art.-Nr. Art. No.	Seite Page	Art.-Nr. Art. No.	Seite Page	Art.-Nr. Art. No.	Seite Page	Art.-Nr. Art. No.	Seite Page
1100.32.96.255	62	1100.50.420	20	1160.07.065	25	1165.48	156	1180.11.120	95
1100.32.98	64	1100.50.91.420	31	1160.07.075	25	1165.50	155	1180.11.91.085	97
1100.32.98.255	64	1100.50.92	31	1160.08.030	19	1165.63	155	1180.11.91.120	97
1100.36	27	1100.50.94	60	1160.08.040	19	1165.80.07.060	161	1180.12.060	93
1100.36.260	26	1100.50.94.420	60	1160.09	25	1165.80.07.075	161	1180.12.075	93
1100.36.305	26	1100.50.96	62	1160.09.105	25	1165.80.09.080	161	1180.12.91.060	96
1100.36.350	26	1100.50.96.420	62	1160.10.040	19	1165.80.09.100	161	1180.12.91.075	96
1100.36.91.350	33	1100.50.98	64	1160.10.060	19	1165.80.10.040	160	1180.13.110	95
1100.36.92	33	1100.50.98.08	226	1160.11	25	1165.80.10.060	160	1180.13.140	95
1100.36.94	61	1100.50.98.420	64	1160.11.120	25	1165.80.11.085	161	1180.13.91.110	97
1100.36.94.350	61	1100.63	21	1160.12.050	19	1165.80.11.120	161	1180.13.91.140	97
1100.36.96	63	1100.63.400	20	1160.12.065	19	1165.80.12.060	160	1180.16.110	95
1100.36.96.350	63	1100.63.460	20	1160.12.075	19	1165.80.12.075	160	1180.16.140	95
1100.36.98	65	1100.63.520	20	1160.13	25	1165.80.13.110	161	1180.16.91.110	97
1100.36.98.350	65	1100.63.91.520	31	1160.13.145	25	1165.80.13.140	161	1180.16.91.140	97
1100.40	21	1100.63.92	31	1160.16	25	1165.80.16.110	161	1180.17.080	93
1100.40.240	20	1100.63.94	60	1160.16.145	25	1165.80.16.140	161	1180.17.100	93
1100.40.285	20	1100.63.94.520	60	1160.17	19	1165.80.17.080	160	1180.17.91.080	96
1100.40.330	20	1100.63.96	62	1160.17.105	19	1165.80.17.100	160	1180.17.91.100	96
1100.40.50	43	1100.63.96.520	62	1160.20	19	1165.80.20.110	160	1180.20.110	93
1100.40.91.330	31	1100.63.98	64	1160.20.145	19	1165.80.20.140	160	1180.20.140	93
1100.40.92	31	1100.63.98.08	226	1160.21	25	1165.80.21.160	161	1180.20.91.110	96
1100.40.94	60	1100.63.98.520	64	1160.21.190	25	1165.80.21.190	161	1180.20.91.140	96
1100.40.94.330	60	1100.75	21	1160.25	19	1165.80.25.160	160	1180.21.160	95
1100.40.96	62	1100.75.500	20	1160.25.190	19	1165.80.25.190	160	1180.21.190	95
1100.40.96.330	62	1100.75.560	20	1160.29	25	1165.80.29.230	161	1180.21.91.160	97
1100.40.98	64	1100.75.630	20	1160.29.275	25	1165.80.29.255	161	1180.21.91.190	97
1100.40.98.08	226	1100.75.98.08	226	1160.32	19	1165.80.32.210	160	1180.25.160	93
1100.40.98.330	64	1105.98.08	226	1160.32.255	19	1165.80.32.250	160	1180.25.190	93
1100.42	27	1106.06.98.08	226	1160.36	25	1165.80.36.305	161	1180.25.91.160	96
1100.42.330	26	1106.98.08	226	1160.36.350	25	1165.80.36.350	161	1180.25.91.190	96
1100.42.370	26	1107.98.08	226	1160.40	19	1165.80.40.285	160	1180.29.230	95
1100.42.420	26	1111.98.08	226	1160.40.330	19	1165.80.40.320	160	1180.29.255	95
1100.42.91.420	33	1113.98.22.08	226	1160.42	25	1165.80.48.430	161	1180.29.91.230	97
1100.42.92	33	1116.98.08	226	1160.42.420	25	1165.80.48.465	161	1180.29.91.255	97
1100.42.94	61	1116.98.25.08	226	1160.48	25	1165.80.50.370	160	1180.32.210	93
1100.42.94.420	61	1121.98.30.08	226	1160.48.490	25	1165.80.50.410	160	1180.32.250	93
1100.42.96	63	1129.98.08	226	1160.50	19	1165.80.63.460	160	1180.32.91.210	96
1100.42.96.420	63	1136.98.08	226	1160.50.420	19	1165.80.63.500	160	1180.32.91.250	96
1100.42.98	65	1145.12.050	178	1160.63	19	1165.84.20.15	162	1180.36.305	95
1100.42.98.08	226	1145.12.070	178	1160.63.520	19	1165.84.25.21	162	1180.36.350	95
1100.42.98.420	65	1145.17.060	178	1160.75	19	1165.84.32.34	162	1180.40.285	93
1100.48	27	1145.17.100	178	1160.75.630	19	1165.84.40.34	162	1180.40.320	93
1100.48.370	26	1145.20.080	178	1165.07	156	1165.84.50.42	162	1180.42.370	95
1100.48.430	26	1145.20.130	178	1165.09	156	1165.84.63.54	162	1180.42.410	95
1100.48.490	26	1145.25.110	178	1165.10	155	1180.07.060	95	1180.48.430	95
1100.48.91.490	33	1145.25.170	178	1165.11	156	1180.07.075	95	1180.48.465	95
1100.48.92	33	1145.32.150	178	1165.12	155	1180.08.035	93	1180.50.370	93
1100.48.94	61	1145.32.210	178	1165.13	156	1180.08.040	93	1180.50.410	93
1100.48.94.490	61	1145.40.230	178	1165.16	156	1180.09.080	95	1180.63.460	93
1100.48.96	63	1145.40.280	178	1165.17	155	1180.09.100	95	1180.63.500	93
1100.48.96.490	63	1145.50.290	178	1165.20	155	1180.09.91.080	97	1181.07.060	91
1100.48.98	65	1145.50.350	178	1165.21	156	1180.09.91.100	97	1181.07.075	91
1100.48.98.08	226	1145.63.390	178	1165.25	155	1180.10.040	93	1181.09.080	91
1100.48.98.490	65	1145.63.480	178	1165.29	156	1180.10.060	93	1181.09.100	91
1100.50	21	1145.63.550	178	1165.32	155	1180.10.91.040	96	1181.11.085	91
1100.50.330	20	1160.06.025	19	1165.36	156	1180.10.91.060	96	1181.11.120	91
1100.50.370	20	1160.06.030	19	1165.40	155	1180.11.085	95	1181.12.060	90

Art.-Nr. Art. No.	Seite Page	Art.-Nr. Art. No.	Seite Page	Art.-Nr. Art. No.	Seite Page	Art.-Nr. Art. No.	Seite Page	Art.-Nr. Art. No.	Seite Page
1181.12.075	90	1300.50.370.070	40	1310.11.2.050	36	1310.32.6.070	34	1311.32.3.105	35
1181.13.110	91	1300.50.400.060	40	1310.11.2.060	36	1311.09.2.030	37	1311.32.4.090	35
1181.13.140	91	1300.50.400.135	40	1310.11.2.075	36	1311.09.2.040	37	1311.32.6.070	35
1181.16.110	91	1300.50.420.140	40	1310.11.3.050	36	1311.09.2.050	37	1370.15	77
1181.16.140	91	1300.63.460.140	40	1310.110.07	229	1311.11.2.050	37	1370.15.30	77
1181.17.080	90	1300.63.465.060	40	1310.120.07	229	1311.11.2.060	37	1370.15.49.04	77
1181.17.100	90	1301.09.090.042	42	1310.13.2.050	36	1311.11.2.075	37	1370.15.49.45	77
1181.20.110	90	1301.13.130.050	42	1310.13.2.060	36	1311.11.3.050	37	1370.15.63.12	77
1181.20.140	90	1301.13.150.050	42	1310.13.2.075	36	1311.13.2.050	37	<b>14...</b>	
1181.21.160	91	1301.16.130.050	42	1310.13.3.050	36	1311.13.2.060	37	14.582.33	194
1181.21.190	91	1301.16.150.050	42	1310.13.3.060	36	1311.13.2.075	37	14.582.34	194
1181.25.160	90	1301.17.090.042	41	1310.13.3.065	36	1311.13.3.050	37	14.582.35	194
1181.25.190	90	1301.20.130.050	41	1310.13.4.050	36	1311.13.3.060	37	14.582.36	194
1181.29.230	91	1301.20.150.050	41	1310.13.4.060	36	1311.13.3.065	37	14.582.37	194
1181.29.255	91	1301.21.190.070	42	1310.16.2.050	36	1311.13.4.050	37	14.582.38	194
1181.32.210	90	1301.21.220.060	42	1310.16.2.060	36	1311.13.4.060	37	14.582.39	194
1181.32.250	90	1301.21.220.080	42	1310.16.2.075	36	1311.16.2.050	37	14.582.93	194
1183.12.050	89	1301.25.190.070	41	1310.16.2.090	36	1311.16.2.060	37	14.582.94	194
1183.12.065	89	1301.29.260.070	42	1310.16.3.050	36	1311.16.2.075	37	14.582.95	194
1183.17	89	1301.29.265.090	42	1310.16.3.060	36	1311.16.2.090	37	14.582.96	194
1183.20	89	1301.29.280.060	42	1310.16.3.070	36	1311.16.3.050	37	14.582.97	194
1183.25	89	1301.29.300.100	42	1310.16.4.050	36	1311.16.3.060	37	14.582.98	194
1183.32	89	1301.29.320.090	42	1310.16.4.060	36	1311.16.3.070	37	14.582.99	194
<b>13...</b>		1301.29.330.065	42	1310.16.4.070	36	1311.16.4.050	37	14.583.03	194
1300.09.090.042	42	1301.32.220.060	41	1310.17.2.030	34	1311.16.4.060	37	14.583.04	194
1300.13.130.050	42	1301.32.220.080	41	1310.17.2.040	34	1311.16.4.070	37	14.583.05	194
1300.13.150.050	42	1301.40.260.070	41	1310.17.2.050	34	1311.17.2.030	35	14.583.06	194
1300.16.130.050	42	1301.40.265.090	41	1310.20.2.050	34	1311.17.2.040	35	14.583.07	194
1300.16.150.050	42	1301.40.280.060	41	1310.20.2.060	34	1311.17.2.050	35	14.583.08	194
1300.17.090.042	40	1301.40.300.100	41	1310.20.2.075	34	1311.20.2.050	35	14.583.09	194
1300.20.130.050	40	1301.40.320.090	41	1310.20.3.050	34	1311.20.2.060	35	1400.11	44
1300.20.150.050	40	1301.40.330.065	41	1310.20.3.060	34	1311.20.2.075	35	1400.16	44
1300.21.190.070	42	1301.42.340.115	42	1310.20.3.065	34	1311.20.3.050	35	1400.17	44
1300.21.220.060	42	1301.42.370.070	42	1310.20.4.050	34	1311.20.3.060	35	1400.20	44
1300.21.220.080	42	1301.42.400.060	42	1310.20.4.060	34	1311.20.3.065	35	1400.21	44
1300.25.190.070	40	1301.42.400.135	42	1310.21.2.070	36	1311.20.4.050	35	1400.25	44
1300.29.260.070	42	1301.42.420.140	42	1310.21.2.090	36	1311.20.4.060	35	<b>15...</b>	
1300.29.265.090	42	1301.48.460.140	42	1310.21.2.100	36	1311.21.2.070	37	1520.11	173
1300.29.280.060	42	1301.48.465.060	42	1310.21.2.115	36	1311.21.2.090	37	1520.16	173
1300.29.300.100	42	1301.50.340.115	41	1310.21.3.070	36	1311.21.2.100	37	1520.16.080	173
1300.29.320.090	42	1301.50.370.070	41	1310.21.3.090	36	1311.21.2.115	37	1520.16.110	173
1300.29.330.065	42	1301.50.400.060	41	1310.21.3.105	36	1311.21.3.070	37	1520.17	169
1300.32.220.060	40	1301.50.400.135	41	1310.21.4.070	36	1311.21.3.090	37	1520.20	169
1300.32.220.080	40	1301.50.420.140	41	1310.21.4.090	36	1311.21.3.105	37	1520.20.080	169
1300.40.260.070	40	1301.63.460.140	41	1310.21.6.060	36	1311.21.4.070	37	1520.20.110	169
1300.40.265.090	40	1301.63.465.060	41	1310.21.6.070	36	1311.21.4.090	37	1520.25	169
1300.40.280.060	40	1310.020.07	229	1310.25.2.070	34	1311.21.6.060	37	1540.07.050	172
1300.40.300.100	40	1310.030.07	229	1310.25.2.090	34	1311.21.6.070	37	1540.07.065	172
1300.40.320.090	40	1310.040.07	229	1310.25.2.100	34	1311.25.2.070	35	1540.07.080	172
1300.40.330.065	40	1310.050.07	229	1310.25.3.070	34	1311.25.2.090	35	1540.08.035	168
1300.42.340.115	42	1310.060.07	229	1310.25.3.090	34	1311.25.2.100	35	1540.08.050	168
1300.42.370.070	42	1310.070.07	229	1310.25.4.070	34	1311.25.3.070	35	1540.09	172
1300.42.400.060	42	1310.080.07	229	1310.25.6.060	34	1311.25.3.090	35	1540.09.060	172
1300.42.400.135	42	1310.09.2.030	36	1310.29.3.090	36	1311.25.4.070	35	1540.09.080	172
1300.42.420.140	42	1310.09.2.040	36	1310.32.2.115	34	1311.25.6.060	35	1540.09.105	172
1300.48.460.140	42	1310.09.2.050	36	1310.32.3.090	34	1311.29.3.090	37	1540.10.040	168
1300.48.465.060	42	1310.090.07	229	1310.32.3.105	34	1311.32.2.115	35	1540.10.060	168
1300.50.340.115	40	1310.100.07	229	1310.32.4.090	34	1311.32.3.090	35	1540.11	172



Art.-Nr. Art. No.	Seite Page	Art.-Nr. Art. No.	Seite Page	Art.-Nr. Art. No.	Seite Page	Art.-Nr. Art. No.	Seite Page	Art.-Nr. Art. No.	Seite Page
1540.11.055	172	1540.63	168	1546.20.12	186	1556.20.1.08	181	1571.13	170
1540.11.085	172	1540.63.400	168	1546.N0375.08	189	1556.20.1.13	181	1571.13.080	170
1540.11.120	172	1540.63.460	168	1546.N0500.07	189	1556.20.13	180	1571.13.110	170
1540.12.050	168	1540.63.520	168	1546.N0500.12	189	1556.21.14	183	1571.13.150	170
1540.12.065	168	1545.07.06	184	1555.07.06	183	1556.21.18	183	1571.13.2.050	175
1540.12.080	168	1545.09.08	184	1555.09.08	183	1556.25.1.11	181	1571.13.2.060	175
1540.13	172	1545.11.07	184	1555.11.07	183	1556.25.1.17	181	1571.13.2.075	175
1540.13.080	172	1545.11.10	184	1555.11.10	183	1556.25.11	180	1571.13.3.050	175
1540.13.110	172	1545.12.06	180	1555.12.06	180	1556.25.17	180	1571.13.3.060	175
1540.13.150	172	1545.12.1.06	182	1555.12.1.06	181	1556.29.25	183	1571.13.3.065	175
1540.16	172	1545.13.07	184	1555.13.07	183	1556.32.1.25	181	1571.13.4.050	175
1540.16.080	172	1545.13.12	184	1555.13.12	183	1556.32.25	180	1571.13.4.060	175
1540.16.110	172	1545.16.11	184	1555.16.11	183	1556.36.33	183	1571.16	170
1540.16.150	172	1545.16.14	184	1555.16.14	183	1556.40.1.33	181	1571.16.080	170
1540.17	168	1545.17.06	180	1555.17.06	180	1556.42.38	183	1571.16.110	170
1540.17.060	168	1545.17.1.06	182	1555.17.1.06	181	1556.48.44	183	1571.16.150	170
1540.17.080	168	1545.17.1.10	182	1555.17.1.10	181	1556.50.1.38	181	1571.16.2.050	175
1540.17.105	168	1545.17.10	180	1555.17.10	180	1556.63.1.44	181	1571.16.2.060	175
1540.20	168	1545.20.08	180	1555.20.08	180	1556.N0375.08	185	1571.16.2.075	175
1540.20.080	168	1545.20.1.08	182	1555.20.1.08	181	1556.N0500.07	185	1571.16.3.050	175
1540.20.110	168	1545.20.1.13	182	1555.20.1.13	181	1556.N0500.12	185	1571.16.3.060	175
1540.20.150	168	1545.20.13	180	1555.20.13	180	1556.N0750.14	185	1571.16.3.065	175
1540.21	172	1545.21.14	184	1555.21.14	183	1556.N0750.18	185	1571.16.4.050	175
1540.21.125	172	1545.21.18	184	1555.21.18	183	1556.N1000.22	185	1571.16.4.060	175
1540.21.160	172	1545.25.1.11	182	1555.25.1.11	181	1570.09	173	1571.17	166
1540.21.205	172	1545.25.1.17	182	1555.25.1.17	181	1570.11	173	1571.17.060	166
1540.25	168	1545.25.11	180	1555.25.11	180	1570.13	173	1571.17.080	166
1540.25.125	168	1545.25.17	180	1555.25.17	180	1570.16	173	1571.17.105	166
1540.25.160	168	1545.29.25	184	1555.29.25	183	1570.17	169	1571.17.2.030	174
1540.25.205	168	1545.32.1.25	182	1555.32.1.25	181	1570.20	169	1571.17.2.040	174
1540.29	172	1545.32.25	180	1555.32.25	180	1570.21	173	1571.17.2.050	174
1540.29.190	172	1545.36.33	184	1555.36.33	183	1570.25	169	1571.20	166
1540.29.230	172	1545.40.1.33	182	1555.40.1.33	181	1570.29	173	1571.20.080	166
1540.29.275	172	1545.42.38	184	1555.42.38	183	1570.32	169	1571.20.110	166
1540.32	168	1545.48.44	184	1555.48.44	183	1571.07.050	170	1571.20.150	166
1540.32.170	168	1545.50.1.38	182	1555.50.1.38	181	1571.07.065	170	1571.20.2.050	174
1540.32.210	168	1545.63.1.44	182	1555.63.1.44	181	1571.07.080	170	1571.20.2.060	174
1540.32.255	168	1545.N0375.08	185	1555.N0375.08	185	1571.08.035	166	1571.20.2.075	174
1540.36	172	1545.N0500.07	185	1555.N0500.07	185	1571.08.050	166	1571.20.3.050	174
1540.36.260	172	1545.N0500.12	185	1555.N0500.12	185	1571.09	170	1571.20.3.060	174
1540.36.305	172	1545.N0750.14	185	1555.N0750.14	185	1571.09.060	170	1571.20.3.065	174
1540.36.350	172	1545.N0750.18	185	1555.N0750.18	185	1571.09.080	170	1571.20.4.050	174
1540.40	168	1545.N1000.22	185	1555.N1000.22	185	1571.09.105	170	1571.20.4.060	174
1540.40.240	168	1546.07.06	188	1556.07.06	183	1571.09.2.030	175	1571.21	170
1540.40.285	168	1546.09.08	188	1556.09.08	183	1571.09.2.040	175	1571.21.125	170
1540.40.330	168	1546.11.07	188	1556.11.07	183	1571.09.2.050	175	1571.21.160	170
1540.42	172	1546.11.10	188	1556.11.10	183	1571.10.040	166	1571.21.2.070	175
1540.42.330	172	1546.12.06	186	1556.12.06	180	1571.10.060	166	1571.21.2.090	175
1540.42.370	172	1546.12.1.06	187	1556.12.1.06	181	1571.11	170	1571.21.2.100	175
1540.42.420	172	1546.13.07	188	1556.13.07	183	1571.11.055	170	1571.21.205	170
1540.48	172	1546.13.12	188	1556.13.12	183	1571.11.085	170	1571.21.3.070	175
1540.48.370	172	1546.16.11	188	1556.16.11	183	1571.11.120	170	1571.21.3.090	175
1540.48.430	172	1546.16.14	188	1556.16.14	183	1571.11.2.050	175	1571.21.4.070	175
1540.48.490	172	1546.17.08	186	1556.17.06	180	1571.11.2.060	175	1571.21.6.060	175
1540.50	168	1546.17.1.08	187	1556.17.1.06	181	1571.11.3.050	175	1571.25	166
1540.50.330	168	1546.20.07	186	1556.17.1.10	181	1571.12.050	166	1571.25.125	166
1540.50.370	168	1546.20.1.07	187	1556.17.10	180	1571.12.065	166	1571.25.160	166
1540.50.420	168	1546.20.1.12	187	1556.20.08	180	1571.12.080	166	1571.25.2.070	174

Art.-Nr. Art. No.	Seite Page	Art.-Nr. Art. No.	Seite Page	Art.-Nr. Art. No.	Seite Page	Art.-Nr. Art. No.	Seite Page	Art.-Nr. Art. No.	Seite Page
1571.25.2.090	174	1572.11.085	171	1572.63.400	167	1700.09.14	154	1710.60.63.56	153
1571.25.2.100	174	1572.11.120	171	1572.63.460	167	1700.11.14	154	1710.80.07.060.1	159
1571.25.205	166	1572.12.050	167	1572.63.520	167	1700.11.17	154	1710.80.09.080.1	159
1571.25.3.070	174	1572.12.065	167	1576.07.06	188	1700.12.1/4	152	1710.80.09.100.1	159
1571.25.3.090	174	1572.12.080	167	1576.09.08	188	1700.12.10	152	1710.80.11.085.1	159
1571.25.4.070	174	1572.13	171	1576.11.07	188	1700.13.19	154	1710.80.11.120.1	159
1571.25.6.060	174	1572.13.080	171	1576.11.10	188	1700.16.17	154	1710.80.12.060.1	157
1571.29	170	1572.13.110	171	1576.12.06	186	1700.16.21	154	1710.80.12.060.2	158
1571.29.190	170	1572.13.150	171	1576.12.1.06	187	1700.17.14	152	1710.80.13.110.1	159
1571.29.230	170	1572.16	171	1576.13.07	188	1700.20.1/2	152	1710.80.13.140.1	159
1571.29.275	170	1572.16.080	171	1576.13.12	188	1700.20.17	152	1710.80.16.110.1	159
1571.29.3.090	175	1572.16.110	171	1576.16.11	188	1700.20.19	152	1710.80.16.140.1	159
1571.32	166	1572.16.150	171	1576.16.14	188	1700.20.21	152	1710.80.17.080.1	157
1571.32.170	166	1572.17	167	1576.17.08	186	1700.20.3/8	152	1710.80.17.080.2	158
1571.32.2.115	174	1572.17.060	167	1576.17.1.08	187	1700.21.27	154	1710.80.17.100.1	157
1571.32.210	166	1572.17.080	167	1576.20.07	186	1700.25.21	152	1710.80.17.100.2	158
1571.32.255	166	1572.17.105	167	1576.20.1.07	187	1700.25.27	152	1710.80.20.110.1	157
1571.32.3.090	174	1572.20	167	1576.20.1.12	187	1700.25.3/4	152	1710.80.20.110.2	157
1571.32.3.105	174	1572.20.080	167	1576.20.12	186	1700.29.36	154	1710.80.20.110.3	158
1571.32.4.090	174	1572.20.110	167	1576.N0375.08	189	1700.32.1	152	1710.80.20.110.4	158
1571.32.6.070	174	1572.20.150	167	1576.N0500.07	189	1700.32.27	152	1710.80.20.140.1	157
1571.36	170	1572.21	171	1576.N0500.12	189	1700.36.45	154	1710.80.20.140.2	157
1571.36.260	170	1572.21.125	171	1577.07.06	188	1700.40.11/4	152	1710.80.20.140.4	158
1571.36.305	170	1572.21.160	171	1577.09.08	188	1700.40.36	152	1710.80.21.160.1	159
1571.36.350	170	1572.21.205	171	1577.11.07	188	1700.42.45	154	1710.80.21.190.1	159
1571.40	166	1572.25	167	1577.11.10	188	1700.48.56	154	1710.80.25.160.1	157
1571.40.240	166	1572.25.125	167	1577.12.06	186	1700.50.45	152	1710.80.25.160.2	158
1571.40.285	166	1572.25.160	167	1577.12.1.06	187	1700.63.2	152	1710.80.25.190.1	157
1571.40.330	166	1572.25.205	167	1577.13.07	188	1700.63.56	152	1710.80.25.190.2	158
1571.42	170	1572.29	171	1577.13.12	188	1710.60.07.10	154	1710.80.29.230.1	159
1571.42.330	170	1572.29.190	171	1577.16.11	188	1710.60.09.14	154	1710.80.29.255.1	159
1571.42.370	170	1572.29.230	171	1577.16.14	188	1710.60.11.14	154	1710.80.32.210.1	157
1571.42.420	170	1572.29.275	171	1577.17.08	186	1710.60.11.17	154	1710.80.32.210.2	158
1571.48	170	1572.32	167	1577.17.1.08	187	1710.60.12.1/4	153	1710.80.32.250.1	157
1571.48.370	170	1572.32.170	167	1577.20.07	186	1710.60.12.10	153	1710.80.32.250.2	158
1571.48.430	170	1572.32.210	167	1577.20.1.07	187	1710.60.13.19	154	1710.80.36.305.1	159
1571.48.490	170	1572.32.255	167	1577.20.1.12	187	1710.60.16.17	154	1710.80.36.350.1	159
1571.50	166	1572.36	171	1577.20.12	186	1710.60.16.21	154	1710.80.40.285.1	157
1571.50.330	166	1572.36.260	171	1577.N0375.08	189	1710.60.17.14	153	1710.80.40.285.2	158
1571.50.370	166	1572.36.305	171	1577.N0500.07	189	1710.60.20.1/2	153	1710.80.40.320.1	157
1571.50.420	166	1572.36.350	171	1577.N0500.12	189	1710.60.20.17	153	1710.80.40.320.2	158
1571.63	166	1572.40	167	<b>16...</b>		1710.60.20.19	153	1710.80.42.370.1	159
1571.63.400	166	1572.40.240	167	1600.17	195	1710.60.20.21	153	1710.80.42.410.1	159
1571.63.460	166	1572.40.285	167	1600.20	195	1710.60.20.3/8	153	1710.80.48.430.1	159
1571.63.520	166	1572.40.330	167	1600.25	195	1710.60.21.27	154	1710.80.48.465.1	159
1572.07.050	171	1572.42	171	1600.32	195	1710.60.25.21	153	1710.80.50.370.1	157
1572.07.065	171	1572.42.330	171	1600.40	195	1710.60.25.27	153	1710.80.50.410.1	157
1572.07.080	171	1572.42.370	171	1600.50	195	1710.60.25.3/4	153	1710.80.63.460.1	157
1572.08.035	167	1572.42.420	171	1600.63	195	1710.60.29.36	154	1710.80.63.460.2	158
1572.08.050	167	1572.48	171	1620.17	195	1710.60.32.1	153	1710.80.63.500.1	157
1572.09	171	1572.48.370	171	1620.20	195	1710.60.32.27	153	1710.80.63.500.2	158
1572.09.060	171	1572.48.430	171	1620.25	195	1710.60.36.45	154	<b>18...</b>	
1572.09.080	171	1572.48.490	171	1620.32	195	1710.60.40.11/4	153	1800.07.03.065	50
1572.09.105	171	1572.50	167	1620.40	195	1710.60.40.36	153	1800.07.03.080	50
1572.10.040	167	1572.50.330	167	1620.50	195	1710.60.42.45	154	1800.07.13.065	51
1572.10.060	167	1572.50.370	167	1620.63	195	1710.60.48.56	154	1800.07.13.080	51
1572.11	171	1572.50.420	167	<b>17...</b>		1710.60.50.45	153	1800.09.03.105	50
1572.11.055	171	1572.63	167	1700.07.10	154	1710.60.63.2	153	1800.09.13.105	51

Art.-Nr. Art. No.	Seite Page	Art.-Nr. Art. No.	Seite Page	Art.-Nr. Art. No.	Seite Page	Art.-Nr. Art. No.	Seite Page	Art.-Nr. Art. No.	Seite Page
1800.10.03.040	48	1800.63.03.520	48	181/2G.11.26	116	1850.36.27	115	2410.50	201
1800.10.03.060	48	1800.63.13.520	49	181/2G.16.26	116	1852.07.05	83	2445.12	198
1800.10.09	55	1800.75.03.630	48	181/2NPT.11.26	117	1852.09.07	83	2450.07.32	200
1800.10.11	55	1800.75.13.630	49	181/2NPT.16.26	117	1852.11.07	83	2450.07.34	199
1800.10.13	55	1801.09	81	1811.02	53	1852.11.09	83	2450.11.32	200
1800.10.13.040	49	1801.10.09	57	1811.26	116	1852.12.05	82	2450.11.34	199
1800.10.13.060	49	1801.10.11	57	1811.26.50	120	1852.13.09	83	2450.12.32	199
1800.10.16	55	1801.10.13	57	1811/2G.36.26	116	1852.13.11	83	2450.12.34	199
1800.10.17	54	1801.10.16	57	1811/2NPT.36.26	117	1852.13.13	83	2450.12.36	200
1800.10.20	54	1801.10.17	56	1811/2NPT.36.27	117	1852.16.07	82	2450.17.32	199
1800.10.21	55	1801.10.20	56	1811/4G.29.27	116	1852.16.13	83	2450.17.34	199
1800.10.25	54	1801.10.21	57	1811/4NPT.29.26	117	1852.16.15	83	2450.17.36	200
1800.10.29	55	1801.10.25	56	1811/4NPT.29.27	117	1852.20.07	82	2450.20.32	199
1800.10.32	54	1801.10.29	57	1812.02	52	1852.20.09	82	2450.20.34	199
1800.10.40	54	1801.10.32	56	1813.02	53	1852.20.11	82	2450.20.36	200
1800.11.03.120	50	1801.10.40	56	1813.26	116	1852.20.13	82	<b>34...</b>	
1800.11.09	55	1801.11	81	1816.02	53	1852.20.15	82	3409.07	216
1800.11.11	55	1801.11.09	57	1816.26	116	1852.21.15	83	3411.07	216
1800.11.13	55	1801.11.11	57	1816.26.50	120	1852.21.17	83	3411.09	216
1800.11.13.120	51	1801.11.13	57	1817.02	52	1852.21.19	83	3413.09	216
1800.11.16	55	1801.11.16	57	1817.09.26	115	1852.21.20	83	3413.11	216
1800.11.17	54	1801.11.17	56	181G.29.26	116	1852.25.15	82	3416.09	216
1800.11.20	54	1801.11.20	56	181NPT.21.26	117	1852.25.17	82	3416.11	216
1800.11.21	55	1801.11.21	57	181NPT.21.27	117	1852.25.19	82	3416.13	216
1800.11.25	54	1801.11.25	56	1820.02	52	1852.25.20	82	3417.09	218
1800.11.29	55	1801.11.29	57	1820.11.26	115	1852.29.20	83	3420.11	218
1800.11.32	54	1801.11.32	56	1820.16.26	115	1852.29.23	83	3421.13	216
1800.11.40	54	1801.11.40	56	1821.02	53	1852.29.25	83	3421.16	216
1800.12.03.065	48	1801.13	81	1821.26	116	1852.32.23	82	3425.16	218
1800.12.03.080	48	1801.16	81	1821.26.50	120	1852.32.25	82	3429.21	216
1800.12.13.065	49	1801.17	81	1821.27	116	1852.36.26	83	3436.29	216
1800.12.13.080	49	1801.20.10	81	1821.27.50	120	1852.36.30	83	3440.29	218
1800.13.03.150	50	1801.20.12	81	1825.02	52	1852.36.33	83	3450.36	218
1800.13.13.150	51	1801.20.14	81	1825.21.26	115	1852.36.35	83	3455.09.12	219
1800.16.03.150	50	1801.21	81	1825.21.27	115	1852.40.26	82	3455.11.17	219
1800.16.13.150	51	1801.25	81	1829.02	53	1852.40.30	82	3455.13.17	219
1800.17.03.105	48	1801.29	81	1829.26	116	1852.40.33	82	3455.13.20	219
1800.17.13.105	49	1801.32	81	1829.26.50	120	1852.40.35	82	3455.16.20	219
1800.20.03.150	48	1803.07	80	1829.27	116	1852.42.35	83	3455.17.12	216
1800.20.13.150	49	1803.09	80	183/4G.21.26	116	1852.42.38	83	3455.20.12	216
1800.21.03.205	50	1803.11	80	183/4G.21.27	116	1852.42.40	83	3455.20.17	216
1800.21.13.205	51	1803.12	80	183/4NPT.11.26	117	1852.48.48.40	83	3455.21.25	219
1800.25.03.205	48	1803.13	80	183/4NPT.16.26	117	1852.48.48.44	83	3455.25.12	216
1800.25.13.205	49	1803.16	80	183/4NPT.21.26	117	1863.48.26	115	3455.25.17	216
1800.29.03.275	50	1803.17	80	183/8G.09.26	116	1863.48.27	115	3455.25.20	216
1800.29.13.275	51	1803.20	80	183/8NPT.09.26	117	<b>20...</b>		3455.29.32	219
1800.32.03.255	48	1803.21	80	1832.02	52	2000-00	230	3455.32.12	216
1800.32.13.255	49	1803.25	80	1832.29.26	115	2000-80	230	3455.32.17	216
1800.36.03.350	50	1803.29	80	1836.02	53	2000-90	230	3455.32.20	216
1800.36.13.350	51	1803.32	80	1836.26	116	<b>21...</b>		3455.32.25	216
1800.40.03.330	48	1803.36	80	1836.27	116	2111.00.08	226	3455.36.40	219
1800.40.13.330	49	1803.40	80	1840.02	52	2111.98.08	226	3455.40.17	216
1800.42.03.410	50	1803.42	80	1840.29.27	115	<b>24...</b>		3455.40.20	216
1800.42.13.410	51	1803.48.48	80	1848.26	116	2410.17	201	3455.40.25	216
1800.48.03.490	50	1807.02	53	1848.27	116	2410.20	201	3455.40.32	216
1800.48.13.490	51	1809.02	53	1848.48.26	116	2410.25	201	3455.50.20	216
1800.50.03.410	48	1809.26	116	1848.48.27	116	2410.32	201	3455.50.25	216
1800.50.13.410	49	1809.26.50	120	1850.36.26	115	2410.40	201	3455.50.32	216

Art.-Nr. Art. No.	Seite Page	Art.-Nr. Art. No.	Seite Page	Art.-Nr. Art. No.	Seite Page	Art.-Nr. Art. No.	Seite Page	Art.-Nr. Art. No.	Seite Page
3455.50.40	216	3500.42.50	212	3545.40.25	207	361/2G.13.08	215	3755.07.17	219
3455.63.25	216	3500.48.40	212	3545.40.32	207	361/2G.16.08	215	3755.09.17	219
3455.63.32	216	3500.48.50	212	3545.50.32	207	361/2NPT.11	215	3755.09.20	219
3455.63.40	216	3500.50.29	211	3545.50.40	207	361/2NPT.13	215	3755.11.20	219
3455.63.50	216	3500.50.32	207	3545.63.40	207	361/2NPT.16	215	3755.12.17	217
3463.48	218	3500.50.40	207	3545.63.50	207	3611.13.08	210	3755.13.25	219
<b>35...</b>		3500.63.36	211	3548.48.36	208	3611.16.08	210	3755.16.25	219
3500.07.06	212	3500.63.40	207	<b>36...</b>		3611.21.08	210	3755.17.20	217
3500.07.08	212	3500.63.50	207	3600.06.08	209	3611/2G.36.08	215	3755.20.25	217
3500.07.10	212	3500.75.50	207	3600.06.10	209	3613.16.08	210	3755.21.32	219
3500.08.06	207	3500.75.63	207	3600.07.12	213	3613.21.08	210	3755.25.32	217
3500.09.06	212	3509.07	208	3600.07.17	213	3616.21.08	210	3755.29.40	219
3500.09.08	212	351/2G.09	214	3600.08.10	209	3616.29.08	210	3755.32.40	217
3500.09.10	212	351/2NPT.09	215	3600.08.12	209	36161/2G.08	214	3755.40.50	217
3500.09.12	212	3511.07	208	3600.09.17	213	361G.29.08	215	3755.42.50	219
3500.10.06	207	3511.09	208	3600.09.20	213	3621.29.08	210	3755.48.63	219
3500.10.08	207	3511/4G.29	214	3600.10.07	211	36213/4G.08	214	3755.50.63	217
3500.11.06	212	3513.07	208	3600.10.09	211	3629.36.08	210	<b>48...</b>	
3500.11.08	212	3513.09	208	3600.10.12	209	363/4G.21.08	215	4800.24	230
3500.11.10	212	3513.11	208	3600.10.17	209	363/4NPT.21	215	4800.36	230
3500.11.12	212	35133/8G	214	3600.11.20	213	363/8G.11.08	215	<b>50...</b>	
3500.11.17	212	3516.09	208	3600.11.25	213	3636.42.08	210	5000.17.50	201
3500.12.08	207	3516.11	208	3600.12.09	211	3636.48.08	214	5000.20.50	201
3500.12.10	207	3516.13	208	3600.12.17	209	3636.48.48.08	210	5000.25.50	201
3500.13.12	212	351G.21	214	3600.12.20	209	3642.48.08	214	5000.32.50	201
3500.13.17	212	351NPT.16	215	3600.13.20	213	3645.07.12	214	5009.50	201
3500.16.12	212	3521.11	208	3600.13.25	213	3645.09.17	214	5011.50	201
3500.16.17	212	3521.13	208	3600.16.25	213	3645.11.20	214	5013.50	201
3500.16.20	212	3521.16	208	3600.16.32	213	3645.12.17	209	5016.50	201
3500.17.07	211	3529.13	208	3600.17.11	211	3645.13.20	214	5021.50	201
3500.17.10	207	3529.16	208	3600.17.20	209	3645.16.25	214	5029.50	201
3500.17.12	207	3529.21	208	3600.20.13	211	3645.17.20	209	5030.013.010	163
3500.20.07	211	352G.36	214	3600.20.16	211	3645.20.25	209	5030.013.014	163
3500.20.09	211	352G.42	214	3600.20.25	209	3645.21.32	214	5030.013.017	163
3500.20.11	211	353/4G.09	214	3600.21.32	213	3645.25.32	209	5030.013.019	163
3500.20.12	207	353/4G.11	214	3600.21.40	213	3645.29.40	214	5030.013.021	163
3500.20.17	207	353/4G.16	214	3600.25.21	211	3645.32.40	209	5030.013.027	163
3500.21.17	212	353/4NPT.11	215	3600.25.32	209	3645.40.50	209	5030.013.036	163
3500.21.20	212	353/4NPT.13	215	3600.29.40	213	3645.50.63	209	5030.013.045	163
3500.21.25	212	353/8G.07	214	3600.29.50	213	365/8G.16.08	215	5030.013.056	163
3500.25.09	211	3536.21	208	3600.32.29	211	367/8G.29.08	215	5031.034.007	163
3500.25.11	211	3536.29	208	3600.32.40	209	<b>37..</b>		5031.034.009	163
3500.25.13	211	3542.29	208	3600.36.50	213	3707.09	217	5031.034.011	163
3500.25.16	211	3542.36	208	3600.36.63	213	3709.11	217	5031.034.013	163
3500.25.17	207	3545.11.17	213	3600.40.36	211	3711.13	217	5031.034.016	163
3500.25.20	207	3545.16.20	213	3600.40.50	209	3712.09	218	5031.034.021	163
3500.29.25	212	3545.17.12	207	3600.42.63	213	3713.16	217	5031.034.029	163
3500.29.32	212	3545.20.12	207	3600.42.75	213	3716.21	217	5031.034.036	163
3500.32.20	207	3545.20.17	207	3600.48.63	213	3720.13	218	5031.034.048	163
3500.32.21	211	3545.21.20	213	3600.48.75	213	3720.16	218	<b>52...</b>	
3500.32.25	207	3545.21.25	213	3600.50.42	211	3721.29	217	5200.07	71
3500.36.32	212	3545.25.17	207	3600.50.48	211	3725.21	218	5200.09	71
3500.36.40	212	3545.25.20	207	3600.50.63	209	3729.36	217	5200.11	71
3500.40.25	207	3545.29.25	213	3600.63.75	209	3732.29	218	5200.12	70
3500.40.29	211	3545.29.32	213	3607.09.08	210	3736.42	217	5200.13	71
3500.40.32	207	3545.32.20	207	3609.11.08	210	3742.48	217	5200.16	71
3500.42.32	212	3545.32.25	207	3609.13.08	210	3750.42	218	5200.17	70
3500.42.40	212	3545.36.40	213	361/2G.11.08	215	3755.07.12	219	5200.20	70

Art.-Nr. Art. No.	Seite Page	Art.-Nr. Art. No.	Seite Page	Art.-Nr. Art. No.	Seite Page	Art.-Nr. Art. No.	Seite Page	Art.-Nr. Art. No.	Seite Page
5200.21	71	5500.40.17	193	5725	75	8000.06.1	202	8025.96	204
5200.25	70	5500.40.20	193	5729	75	8000.08	202	8025.98	204
5200.29	71	5500.40.25	193	5732	75	8000.08.1	202	8029	202
5200.32	70	5500.40.32	193	<b>68...</b>		8000.080	202	8029.85	102
5200.40	70	5500.40.40	193	6850.40.03	233	8000.085	202	8029.96	204
5210.07	71	5500.40.50	193	6850.40.04	233	8000.095	202	803/4G	202
5210.09	71	5509	76	6850.40.05	233	8000.10	202	803/8G	202
5210.11	71	5513	76	6850.40.06	233	8000.10.1	202	8032.85	102
5210.12	70	5516	76	6850.40.08	233	8000.100	202	8032.96	204
5210.13	71	5516.10	76	6850.40.10	233	8000.105	202	8032.98	204
5210.16	71	5516.12	76	6850.40.12	233	8000.115	202	8036	202
5210.17	70	5516.13	76	6850.40.14	233	8000.12	202	8036.85	102
5210.20	70	5517	76	6850.40.16	233	8000.17	202	8036.96	204
5210.21	71	5520	76	6850.40.18	233	8000.20	202	8040.85	102
5210.25	70	5520.11	193	6850.40.20	233	8000.25	202	8040.96	204
5210.29	71	5520.16	193	6850.40.22	233	8000.32	202	8040.98	204
5210.32	70	5520.21	193	6850.40.24	233	8000.40	202	8042	202
5210.40	70	5520.29	193	6850.40.25	233	8000.50	202	8042.85	102
5215.07	73	5520.36	193	6850.40.30	233	8000.63	202	8048	202
5215.09	73	5520.48.48	193	6850.40.35	233	8000.75	202	8048.48	202
5215.09.65	192	5521	76	6850.40.40	233	8007	202	8048.85	102
5215.09.95	192	5521.10	76	6850.40.45	233	8007.85	102	805/8G	202
5215.11	73	5525	76	6850.40.50	233	8007.96	204	8050	202
5215.11.105	192	5529	76	6850.40.70	233	8008.85	102	8050.85	102
5215.11.65	192	5529.10	76	6875.40.03	232	8008.96	204	8050.96	204
5215.11.95	192	5532	76	6875.40.04	232	8008.98	204	8050.98	204
5215.12	72	5536	76	6875.40.05	232	8009	202	8051	202
5215.13	73	5536.10	76	6875.40.05.10	232	8009.85	102	8063.85	102
5215.13.105	192	5540	76	6875.40.08	232	8009.96	204	8063.96	204
5215.13.13	192	5540.11	193	6875.40.10	232	801/2G	202	8063.98	204
5215.13.95	192	5540.16	193	6875.40.10.10	232	8010.85	102	<b>82...</b>	
5215.16	73	5540.21	193	6875.40.15	232	8010.96	204	8207	205
5215.16.105	192	5540.29	193	6875.40.18.06	232	8010.98	204	8207.40	205
5215.16.13	192	5540.36	193	6875.40.20	232	8011	202	8209	205
5215.16.155	192	5540.48.48	193	6875.40.24	232	8011.85	102	8209.40	205
5215.16.95	192	5550	76	6875.40.30.06	232	8011.96	204	8211	205
5215.17	72	5563	76	6875.40.36	232	8011/2G	202	8211.40	205
5215.17.40.95	192	<b>56...</b>		6875.40.50	232	8011/4G	202	8212	205
5215.17.95	192	5607	74	6875.70.03	232	8012.85	102	8212.40	205
5215.20	72	5609	74	6875.70.04	232	8012.96	204	8213	205
5215.20.105	192	5611	74	6875.70.05	232	8012.98	204	8213.40	205
5215.20.13	192	5612	74	6875.70.08	232	8013	202	8216	205
5215.20.40.105	192	5613	74	6875.70.10	232	8013.85	102	8216.40	205
5215.20.40.13	192	5616	74	6875.70.15	232	8013.96	204	8217	205
5215.21	73	5617	74	6875.70.20	232	8016	202	8217.40	205
5215.25	72	5620	74	6875.70.24	232	8016.85	102	8220	205
5215.25.155	192	5621	74	6875.70.36	232	8016.96	204	8220.40	205
5215.25.40.155	192	5625	74	6875.70.50	232	8017.85	102	8221	205
5215.29	73	5629	74	6878.40.06	234	8017.96	204	8221.40	205
5215.32	72	5632	74	6878.40.09	234	8017.98	204	8225	205
5215.40	72	5636	74	6878.40.13	234	801G	202	8225.40	205
<b>55...</b>		5640	74	6878.40.19	234	8020.85	102	8229	205
5500.20.17	193	5650	74	6878.40.25	234	8020.96	204	8229.40	205
5500.20.20	193	5711	75	6878.40.32	234	8020.98	204	8232	205
5500.20.25	193	5716	75	6878.40.38	234	8021	202	8232.40	205
5500.20.32	193	5717	75	6878.40.50	234	8021.85	102	8236	205
5500.20.40	193	5720	75	<b>80...</b>		8021.96	204	8236.40	205
5500.20.50	193	5721	75	8000.06	202	8025.85	102	8240	205

Art.-Nr. Art. No.	Seite Page	Art.-Nr. Art. No.	Seite Page	Art.-Nr. Art. No.	Seite Page	Art.-Nr. Art. No.	Seite Page	Art.-Nr. Art. No.	Seite Page
8240.40	205	8300.29	203	8717.96.11.08.70	222	8775.96.08.70	222	B 116	79
8242	205	8300.32	203	8720.08	220	8775.96.11.08	223	B 116.00.03	228
8242.40	205	8300.32.1	203	8720.11.08	220	8775.96.11.08.70	222	B 117	78
8245.07	206	8300.40	203	8720.96.08	223	<b>88...</b>		B 120.10	78
8245.09	206	8300.40.1	203	8720.96.08.70	222	8807	224	B 120.12	78
8245.11	206	8300.50.1	203	8720.96.11.08	223	8809	224	B 120.14	78
8245.12	206	8300.63.1	203	8720.96.11.08.70	222	8811	224	B 121	79
8245.13	206	8324.12	200	8721.08	221	8813	224	B 121.00.03	228
8245.16	206	8324.17	200	8721.11.08	221	8816	224	B 125	78
8245.17	206	8324.20	200	8725.08	220	8821	224	B 129	79
8245.20	206	<b>87...</b>		8725.11.08	220	8829	224	B 129.00.03	228
8245.21	206	8706.08	220	8725.96.08	223	8836	224	B 132	78
8245.25	206	8706.11.08	220	8725.96.08.70	222	8841.07	149	B 136	79
8245.29	206	8707.08	221	8725.96.11.08	223	8841.09	149	B 136.00.03	228
8245.32	206	8707.11.08	221	8725.96.11.08.70	222	8841.11	149	B 140	78
8245.36	206	8708.08	220	8729.08	221	8841.12	149	B 142	79
8245.40	206	8708.11.08	220	8729.11.08	221	8841.13	149	B 142.00.03	228
8245.42	206	8709.08	221	8732.08	220	8841.16	149	B 148.00.03	228
8245.48	206	8709.11.08	221	8732.11.08	220	8841.17	149	B 148.48	79
8245.50	206	8710.07	119	8732.96.08	223	8841.20	149	B 150	78
8245.63	206	8710.08	220	8732.96.08.70	222	8841.21	149	B 163	78
8248.48	205	8710.09	119	8732.96.11.08	223	8841.25	149	<b>B 2...</b>	
8248.48.40	205	8710.11	119	8732.96.11.08.70	222	8841.29	149	B 209	79
8250	205	8710.11.08	220	8736.08	221	8841.32	149	B 211	79
8250.40	205	8710.12	119	8736.11.08	221	8841.36	149	B 212	78
8255.07	206	8710.13	119	8740.08	220	8841.40	149	B 213	79
8255.09	206	8710.16	119	8740.11.08	220	8841.42	149	B 216	79
8255.11	206	8710.17	119	8740.96.08	223	8841.48	149	B 217	78
8255.12	206	8710.20	119	8740.96.08.70	222	8841.50	149	B 220.10	78
8255.13	206	8710.21	119	8740.96.11.08	223	8841.63	149	B 220.12	78
8255.16	206	8710.25	119	8740.96.11.08.70	222	8842	224	B 220.14	78
8255.17	206	8710.29	119	8742.08	221	8845.12	224	B 221	79
8255.20	206	8710.32	119	8745.12	221	8845.17	224	B 225	78
8255.21	206	8710.36	119	8745.17	221	8845.20	224	B 229	79
8255.25	206	8710.40	119	8745.20	221	8845.25	224	B 232	78
8255.29	206	8710.50	119	8745.25	221	8845.32	224	B 236	79
8255.32	206	8710.63	119	8745.32	221	8845.40	224	B 240	78
8255.36	206	8710.96.08	223	8745.40	221	8845.50	224	B 242	79
8255.40	206	8710.96.08.70	222	8745.50	221	8845.63	224	B 248.48	79
8255.42	206	8710.96.11.08	223	8745.63	221	8848.48	224	B 250	78
8255.48	206	8710.96.11.08.70	222	8748.08	221	8855.12	224	B 263	78
8255.50	206	8711.08	221	8748.11.08	221	8855.17	224	<b>EX10...</b>	
8255.63	206	8711.11.08	221	8748.48.08	221	8855.20	224	EX1000.07.065	122
<b>83...</b>		8712.08	220	8750.08	220	8855.25	224	EX1000.07.080	122
8300.07	203	8712.11.08	220	8750.11.08	220	8855.32	224	EX1000.08.035	121
8300.09	203	8712.96.08	223	8750.96.08	223	8855.40	224	EX1000.08.050	121
8300.11	203	8712.96.08.70	222	8750.96.08.70	222	8855.50	224	EX1000.09.060	122
8300.12	203	8712.96.11.08	223	8750.96.11.08	223	8855.63	224	EX1000.09.080	122
8300.12.1	203	8712.96.11.08.70	222	8750.96.11.08.70	222	<b>B 1...</b>		EX1000.10.040	121
8300.13	203	8713.08	221	8763.08	220	B 107	79	EX1000.10.060	121
8300.16	203	8713.11.08	221	8763.11.08	220	B 107.00.03	228	EX1000.11.055	122
8300.17	203	8716.08	221	8763.96.08	223	B 109	79	EX1000.11.085	122
8300.17.1	203	8716.11.08	221	8763.96.08.70	222	B 109.00.03	228	EX1000.12.065	121
8300.20	203	8717.08	220	8763.96.11.08	223	B 111	79	EX1000.12.080	121
8300.20.1	203	8717.11.08	220	8763.96.11.08.70	222	B 111.00.03	228	EX1000.13.080	122
8300.21	203	8717.96.08	223	8775.08	220	B 112	78	EX1000.13.110	122
8300.25	203	8717.96.08.70	222	8775.11.08	220	B 113	79	EX1000.16.080	122
8300.25.1	203	8717.96.11.08	223	8775.96.08	223	B 113.00.03	228	EX1000.16.110	122



Art.-Nr. Art. No.	Seite Page	Art.-Nr. Art. No.	Seite Page	Art.-Nr. Art. No.	Seite Page	Art.-Nr. Art. No.	Seite Page	Art.-Nr. Art. No.	Seite Page
EX1000.17.060	121	EX1081.17.100	130	<b>EX13...</b>		EX1530.25.160	142	EX1540.20.6.030	140
EX1000.17.080	121	EX1081.20.110	130	EX1310.09.2.030	124	EX1530.25.190	142	EX1540.21.125	139
EX1000.20.080	121	EX1081.20.140	130	EX1310.09.4.015	124	EX1530.25.205	142	EX1540.21.160	139
EX1000.20.110	121	EX1081.21.160	130	EX1310.11.2.040	124	EX1530.29.210	143	EX1540.21.190	139
EX1000.21.125	122	EX1081.21.190	130	EX1310.11.2.050	124	EX1530.29.230	143	EX1540.21.205	139
EX1000.21.160	122	EX1081.25.160	130	EX1310.11.3.030	124	EX1530.29.250	143	EX1540.21.3.090	141
EX1000.25.125	121	EX1081.25.190	130	EX1310.12.3.010	123	EX1530.29.275	143	EX1540.21.4.070	141
EX1000.25.160	121	EX1081.29.230	130	EX1310.13.2.050	124	EX1530.32.210	142	EX1540.25.125	137
EX1000.29.190	122	EX1081.29.255	130	EX1310.13.3.040	124	EX1530.32.220	142	EX1540.25.160	137
EX1000.29.230	122	EX1081.32.210	130	EX1310.16.2.060	124	EX1530.32.230	142	EX1540.25.190	137
EX1000.32.170	121	<b>EX11...</b>		EX1310.16.3.060	124	EX1530.32.255	142	EX1540.25.2.100	140
EX1000.32.210	121	EX1100.07.065	122	EX1310.16.6.030	124	EX1530.36.285	143	EX1540.25.205	137
EX1000.36.260	122	EX1100.07.080	122	EX1310.16.6.040	124	EX1530.36.305	143	EX1540.25.3.090	140
EX1000.36.305	122	EX1100.08.035	121	EX1310.17.2.030	123	EX1530.36.325	143	EX1540.25.4.070	140
EX1000.40.240	121	EX1100.08.050	121	EX1310.17.4.015	123	EX1530.36.350	143	EX1540.25.6.060	140
EX1000.40.285	121	EX1100.09.060	122	EX1310.20.2.050	123	EX1530.40.270	142	EX1540.29.210	139
EX1080.07.060	132	EX1100.09.080	122	EX1310.20.2.075	123	EX1530.40.285	142	EX1540.29.230	139
EX1080.07.075	132	EX1100.10.040	121	EX1310.20.3.060	123	EX1530.40.300	142	EX1540.29.250	139
EX1080.08.035	131	EX1100.10.060	121	EX1310.20.4.050	123	EX1530.40.330	142	EX1540.29.275	139
EX1080.08.040	131	EX1100.11.055	122	EX1310.20.6.030	123	EX1530.42.350	143	EX1540.29.3.090	141
EX1080.09.080	132	EX1100.11.085	122	EX1310.21.3.090	124	EX1530.42.370	143	EX1540.29.6.065	141
EX1080.09.100	132	EX1100.12.065	121	EX1310.21.4.070	124	EX1530.42.390	143	EX1540.32.210	137
EX1080.10.040	131	EX1100.12.080	121	EX1310.25.2.100	123	EX1530.42.420	143	EX1540.32.220	137
EX1080.10.060	131	EX1100.13.080	122	EX1310.25.3.070	123	EX1530.48.430	143	EX1540.32.230	137
EX1080.11.085	132	EX1100.13.110	122	EX1310.25.3.090	123	EX1530.48.450	143	EX1540.32.255	137
EX1080.11.120	132	EX1100.16.080	122	EX1310.25.4.070	123	EX1530.48.470	143	EX1540.32.4.090	140
EX1080.12.060	131	EX1100.16.110	122	EX1310.25.6.060	123	EX1530.48.490	143	EX1540.32.6.070	140
EX1080.12.075	131	EX1100.17.060	121	EX1310.29.3.090	124	EX1530.50.350	142	EX1540.36.2.150	141
EX1080.13.110	132	EX1100.17.080	121	EX1310.29.6.065	124	EX1530.50.370	142	EX1540.36.285	139
EX1080.13.140	132	EX1100.20.080	121	EX1310.32.4.090	123	EX1530.50.390	142	EX1540.36.305	139
EX1080.16.110	132	EX1100.20.110	121	EX1310.32.6.070	123	EX1530.50.420	142	EX1540.36.325	139
EX1080.16.140	132	EX1100.21.125	122	EX1310.36.2.150	124	EX1530.63.440	142	EX1540.36.350	139
EX1080.17.080	131	EX1100.21.160	122	EX1310.36.4.100	124	EX1530.63.460	142	EX1540.36.4.100	141
EX1080.17.100	131	EX1100.25.125	121	EX1310.40.2.150	123	EX1530.63.480	142	EX1540.40.2.150	140
EX1080.20.110	131	EX1100.25.160	121	EX1310.40.7.090	123	EX1530.63.520	142	EX1540.40.270	137
EX1080.20.140	131	EX1100.29.190	122	EX1310.48.3.180	124	EX1540.09.060	139	EX1540.40.285	137
EX1080.21.160	132	EX1100.29.230	122	EX1310.48.6.120	124	EX1540.09.080	139	EX1540.40.300	137
EX1080.21.190	132	EX1100.32.170	121	EX1310.50.4.100	123	EX1540.09.2.030	141	EX1540.40.330	137
EX1080.25.160	131	EX1100.32.210	121	EX1310.63.3.180	123	EX1540.09.4.015	141	EX1540.40.7.090	140
EX1080.25.190	131	EX1100.36.260	122	EX1310.63.6.120	123	EX1540.11.055	139	EX1540.42.350	139
EX1080.29.230	132	EX1100.36.305	122	<b>EX15...</b>		EX1540.11.085	139	EX1540.42.370	139
EX1080.29.255	132	EX1100.40.240	121	EX1530.09.060	143	EX1540.11.2.050	141	EX1540.42.390	139
EX1080.32.210	131	EX1100.40.285	121	EX1530.09.080	143	EX1540.11.3.030	141	EX1540.42.4.100	141
EX1080.36.305	132	EX1126.17.070	118	EX1530.11.055	143	EX1540.13.080	139	EX1540.42.420	139
EX1080.40.285	131	EX1126.17.100	118	EX1530.11.085	143	EX1540.13.110	139	EX1540.48.3.180	141
EX1081.07.060	130	EX1126.20.110	118	EX1530.13.080	143	EX1540.13.2.050	141	EX1540.48.430	139
EX1081.07.075	130	EX1126.20.140	118	EX1530.13.110	143	EX1540.13.3.040	141	EX1540.48.450	139
EX1081.09.080	130	EX1126.25.150	118	EX1530.16.080	143	EX1540.16.080	139	EX1540.48.470	139
EX1081.09.100	130	EX1126.25.180	118	EX1530.16.110	143	EX1540.16.110	139	EX1540.48.490	139
EX1081.11.085	130	EX1126.32.230	118	EX1530.17.060	142	EX1540.16.3.060	141	EX1540.48.6.120	141
EX1081.11.120	130	EX1126.32.260	118	EX1530.17.080	142	EX1540.16.6.030	141	EX1540.50.350	137
EX1081.12.060	130	EX1126.40.260	118	EX1530.20.080	142	EX1540.17.060	137	EX1540.50.370	137
EX1081.12.075	130	EX1126.40.320	118	EX1530.20.110	142	EX1540.17.080	137	EX1540.50.390	137
EX1081.13.110	130	EX1126.50.360	118	EX1530.21.125	143	EX1540.17.2.030	140	EX1540.50.4.100	140
EX1081.13.140	130	EX1126.50.420	118	EX1530.21.160	143	EX1540.17.4.015	140	EX1540.50.420	137
EX1081.16.110	130	EX1126.63.440	118	EX1530.21.190	143	EX1540.20.080	137	EX1540.63.3.180	140
EX1081.16.140	130	EX1126.63.500	118	EX1530.21.205	143	EX1540.20.110	137	EX1540.63.440	137
EX1081.17.080	130			EX1530.25.125	142	EX1540.20.2.050	140	EX1540.63.460	137

Art.-Nr. Art. No.	Seite Page	Art.-Nr. Art. No.	Seite Page	Art.-Nr. Art. No.	Seite Page	Art.-Nr. Art. No.	Seite Page	Art.-Nr. Art. No.	Seite Page
EX1540.63.480	137	EX1571.36.4.100	141	EX1801.21	129	EX1803.80.50.410	133	<b>EX35...</b>	
EX1540.63.520	137	EX1571.40.2.150	140	EX1801.25	128	EX1803.80.63.460	133	EX3500.63.50	144
EX1540.63.6.120	140	EX1571.40.270	136	EX1801.29	129	EX1803.80.63.500	133	EX3600.07.12	147
EX1571.09.060	138	EX1571.40.285	136	EX1801.32	128	EX1811.09	129	EX3600.07.17	147
EX1571.09.080	138	EX1571.40.300	136	EX1801.40	128	EX1811.11	129	EX3600.08.10	146
EX1571.09.2.030	141	EX1571.40.330	136	EX1803.07.03.065	126	EX1811.13	129	EX3600.09.17	147
EX1571.09.4.015	141	EX1571.40.7.090	140	EX1803.07.03.080	126	EX1811.16	129	EX3600.09.20	147
EX1571.11.055	138	EX1571.42.350	138	EX1803.09	127	EX1811.17	128	EX3600.10.12	146
EX1571.11.085	138	EX1571.42.370	138	EX1803.11	127	EX1811.20	128	EX3600.11.20	147
EX1571.11.2.050	141	EX1571.42.390	138	EX1803.12.03.065	125	EX1811.21	129	EX3600.11.25	147
EX1571.11.3.030	141	EX1571.42.4.100	141	EX1803.12.03.080	125	EX1811.25	128	EX3600.12.17	146
EX1571.13.080	138	EX1571.42.420	138	EX1803.13	127	EX1811.29	129	EX3600.13.20	147
EX1571.13.110	138	EX1571.48.3.180	141	EX1803.16	127	EX1811.32	128	EX3600.13.25	147
EX1571.13.2.050	141	EX1571.48.430	138	EX1803.17	125	EX1811.40	128	EX3600.16.25	147
EX1571.13.3.040	141	EX1571.48.450	138	EX1803.20	125	<b>EX35...</b>		EX3600.16.32	147
EX1571.16.080	138	EX1571.48.470	138	EX1803.21	127	EX3500.07.08	145	EX3600.17.20	146
EX1571.16.110	138	EX1571.48.490	138	EX1803.25	125	EX3500.07.10	145	EX3600.20.25	146
EX1571.16.3.060	141	EX1571.48.6.120	141	EX1803.29	127	EX3500.09.08	145	EX3600.21.32	147
EX1571.16.6.030	141	EX1571.50.350	136	EX1803.32	125	EX3500.09.10	145	EX3600.21.40	147
EX1571.17.060	136	EX1571.50.370	136	EX1803.36	127	EX3500.09.12	145	EX3600.25.32	146
EX1571.17.080	136	EX1571.50.390	136	EX1803.40	125	EX3500.10.08	144	EX3600.29.40	147
EX1571.17.2.030	140	EX1571.50.4.100	140	EX1803.42	127	EX3500.11.08	145	EX3600.29.50	147
EX1571.17.4.015	140	EX1571.50.420	136	EX1803.48	127	EX3500.11.10	145	EX3600.32.40	146
EX1571.20.080	136	EX1571.63.3.180	140	EX1803.50	125	EX3500.11.12	145	EX3600.36.50	147
EX1571.20.110	136	EX1571.63.440	136	EX1803.63	125	EX3500.11.17	145	EX3600.36.63	147
EX1571.20.2.050	140	EX1571.63.460	136	EX1803.80.07.060	134	EX3500.12.08	144	EX3600.40.50	146
EX1571.20.6.030	140	EX1571.63.480	136	EX1803.80.07.075	134	EX3500.12.10	144	EX3600.42.63	147
EX1571.21.125	138	EX1571.63.520	136	EX1803.80.09.080	134	EX3500.13.12	145	EX3600.48.63	147
EX1571.21.160	138	EX1571.63.6.120	140	EX1803.80.09.100	134	EX3500.13.17	145	EX3600.50.63	146
EX1571.21.190	138	<b>EX17...</b>		EX1803.80.11.085	134	EX3500.16.12	145	<b>EX87...</b>	
EX1571.21.205	138	EX1700.12.10.065	135	EX1803.80.11.120	134	EX3500.16.17	145	EX8707.08	148
EX1571.21.3.090	141	EX1700.17.14.060	135	EX1803.80.12.060	133	EX3500.16.20	145	EX8708.08	148
EX1571.21.4.070	141	EX1700.17.14.080	135	EX1803.80.12.075	133	EX3500.17.10	144	EX8709.08	148
EX1571.25.125	136	EX1700.17.14.105	135	EX1803.80.13.110	134	EX3500.17.12	144	EX8710.08	148
EX1571.25.160	136	EX1700.20.17.080	135	EX1803.80.13.140	134	EX3500.20.12	144	EX8711.08	148
EX1571.25.190	136	EX1700.20.17.110	135	EX1803.80.16.110	134	EX3500.20.17	144	EX8712.08	148
EX1571.25.2.100	140	EX1700.20.19.080	135	EX1803.80.16.140	134	EX3500.21.17	145	EX8713.08	148
EX1571.25.205	136	EX1700.20.19.110	135	EX1803.80.17.080	133	EX3500.21.20	145	EX8716.08	148
EX1571.25.3.090	140	EX1700.20.19.150	135	EX1803.80.17.100	133	EX3500.21.25	145	EX8717.08	148
EX1571.25.4.070	140	EX1700.20.21.080	135	EX1803.80.20.110	133	EX3500.25.17	144	EX8720.08	148
EX1571.25.6.060	140	EX1700.20.21.110	135	EX1803.80.20.140	133	EX3500.25.20	144	EX8721.08	148
EX1571.29.210	138	EX1700.20.21.150	135	EX1803.80.21.160	134	EX3500.29.25	145	EX8725.08	148
EX1571.29.230	138	EX1700.25.21.125	135	EX1803.80.21.190	134	EX3500.29.32	145	EX8729.08	148
EX1571.29.250	138	EX1700.25.21.160	135	EX1803.80.25.160	133	EX3500.32.20	144	EX8732.08	148
EX1571.29.275	138	EX1700.25.27.125	135	EX1803.80.25.190	133	EX3500.32.25	144	EX8736.08	148
EX1571.29.3.090	141	EX1700.25.27.160	135	EX1803.80.29.230	134	EX3500.36.32	145	EX8740.08	148
EX1571.29.6.065	141	EX1700.25.27.205	135	EX1803.80.29.255	134	EX3500.36.40	145	EX8748.08	148
EX1571.32.210	136	EX1700.32.27.210	135	EX1803.80.32.210	133	EX3500.40.25	144	EX8750.08	148
EX1571.32.220	136	EX1700.40.36.285	135	EX1803.80.32.250	133	EX3500.40.32	144	EX8763.08	148
EX1571.32.230	136	EX1700.50.45.370	135	EX1803.80.36.305	134	EX3500.42.32	145		
EX1571.32.255	136	EX1700.63.56.460	135	EX1803.80.36.350	134	EX3500.42.40	145		
EX1571.32.4.090	140	<b>EX18...</b>		EX1803.80.40.285	133	EX3500.42.50	145		
EX1571.32.6.070	140	EX1801.09	129	EX1803.80.40.320	133	EX3500.48.40	145		
EX1571.36.2.150	141	EX1801.11	129	EX1803.80.42.370	134	EX3500.48.50	145		
EX1571.36.285	138	EX1801.13	129	EX1803.80.42.410	134	EX3500.50.32	144		
EX1571.36.305	138	EX1801.16	129	EX1803.80.48.430	134	EX3500.50.40	144		
EX1571.36.325	138	EX1801.17	128	EX1803.80.48.465	134	EX3500.63.40	144		
EX1571.36.350	138	EX1801.20	128	EX1803.80.50.370	133				

# Liefer- und Zahlungsbedingungen

Es gelten die „Allgemeinen Lieferbedingungen des ZVEI für Erzeugnisse und Leistungen der Elektroindustrie“ in der gültigen Fassung sowie die nachfolgenden Zusatz-Bedingungen der KAISER GmbH & Co.KG.

Erfüllungsort ist Schalksmühle, Gerichtsstand Lüdenscheid.

## 1. Umfang der Lieferungen oder Leistungen

Für den Umfang der Lieferungen oder Leistungen sind die beiderseitigen schriftlichen Erklärungen maßgebend. Ist ein Vertrag geschlossen worden, ohne dass solche beiderseitigen Erklärungen vorliegen, so ist entweder die schriftliche Auftragsbestätigung des Lieferers oder Leistenden (im Folgenden: Lieferer), falls eine solche nicht erfolgt ist, der schriftliche Auftrag des Bestellers maßgebend. Nebenabreden sind nur wirksam, wenn sie schriftlich bestätigt sind.

## 2. Preise

Die Bruttopreise sind unverbindliche Preisempfehlungen ohne Mehrwertsteuer in Euro. Die Preise der Produkte aus Messing unterliegen gewissen Schwankungen, die sich an der jeweiligen DEL-Notierung orientieren. Diese Preise basieren auf einer DEL-Notierung von 150 Euro für Ms 58. Bei einer Veränderung dieses Kurses um mehr als 15 Euro nach oben oder unten wird pro 15 Punkte ein fünfprozentiger Zu- oder Abschlag angerechnet. Für die Kalkulation der Zu- oder Abschläge wird jeweils die DEL-Notiz des Datums zu Grunde gelegt, an dem der Auftrag bei uns eingegangen ist.

## 3. Gefahrübergang

Die Gefahr geht auf den Besteller über, auch dann, wenn frachtfreie Lieferung vereinbart worden ist:

1. Bei Lieferung ohne Aufstellung oder Montage, wenn die betriebsbereite Sendung zum Versand gebracht oder abgeholt worden ist. Die Verpackung erfolgt mit bester Sorgfalt. Der Versand erfolgt nach bestem Ermessen des Lieferers. Auf Wunsch und Kosten des Bestellers wird die Sendung vom Lieferer gegen Bruch-, Transport- und Feuer-schäden versichert.
2. Wenn der Versand, die Zustellung oder der Beginn oder die Durchführung der Aufstellung oder Montage auf Wunsch des Bestellers oder aus von ihm zu vertretenden Gründen verzögert wird, so geht die Gefahr für die Zeit der Verzögerung auf den Besteller über; jedoch ist der Lieferer verpflichtet, auf Wunsch und Kosten des Bestellers die von ihm verlangten Versicherungen zu bewirken.

## 4. Eigentumsvorbehalt

Die Waren bleiben Eigentum des Lieferers bis zur Erfüllung sämtlicher ihm gegen den Besteller aus der Geschäftsverbindung zustehenden Ansprüche. Vorher ist Verpfändung oder Sicherungsübereignung untersagt und Weiterveräußerung nur Wiederverkäufern im gewöhnlichen Geschäftsgang unter der Bedingung gestattet, dass der Wiederverkäufer von seinen Kunden Bezahlung erhält. Etwaige Kosten von Interventionen trägt der Besteller. So weit der Wert aller Sicherungsrechte, die dem Lieferer nach Satz 1 zustehen, die Höhe aller gesicherten Ansprüche um mehr als 20 v.H. übersteigt, wird der Lieferer auf Wunsch des Bestellers einen entsprechenden Teil der Sicherungsrechte freigeben. Verhält sich der Besteller vertragswidrig, kommt er insbesondere in Zahlungsverzug, ist der Lieferer berechtigt, die im Eigentum stehende Ware zurückzunehmen oder ggf. Abtretungen oder Herausgabeansprüche gegen Dritte geltend zu machen. Sämtliche Kosten der Rücknahme und der Verwertung der Gegenstände trägt der Besteller. Die Rücknahme der unter Eigentumsvorbehalt stehenden Ware durch den Lieferer gilt nicht als Rücktritt vom Vertrag.

Sollen betriebsfremde Lagerkapazitäten für unter Eigentumsvorbehalt gelieferte Waren benutzt werden, ist dies dem Lieferer anzuzeigen. Der Besteller hat durch Einzelvereinbarung mit dem Lagerhalter dafür Sorge zu tragen, dass etwaige Pfandrechte an den im Eigentum des Lieferer stehenden Waren nicht zur Entstehung gelangen. Bei Einlieferung ist der Lagerhalter schriftlich darauf hinzuweisen, dass die in Rede stehenden Waren Eigentum des Lieferers sind und nur unter Bedingung der Vermeidung eines Lagerhalterpfandrechts bei diesem eingelagert werden.

## 5. Zahlungsbedingungen

1. Die Zahlungen sind zu leisten frei Zahlstelle des Lieferers in Euro.
2. Der Besteller kann nur mit solchen Forderungen aufrechnen, die unbestritten oder rechtskräftig festgestellt sind.
3. Sind keine anders lautenden Zahlungsbedingungen vereinbart, so gelten 30 Tage netto, jeweils ab Rechnungsdatum.

## 6. Versandkosten

Die Preise gelten für Lieferbedingungen ab Werk bei Abnahme geschlossener Versandkartons verpackungskostenfrei. Angebrochene Kartons verursachen unabhängig von der Auftragshöhe einen Aufpreis von 5,- Euro je Karton.

## 7. Franco-Lieferung

Aufträge zur geschlossenen Lieferung innerhalb der Bundesrepublik Deutschland im Werte ab netto 800,- Euro werden frei Haus geliefert.

## 8. Retouren

Warenrücksendungen können nur in Ausnahmefällen und erst nach unserer Genehmigung erfolgen. Bei Nichtbenachrichtigung werden Retouren auch von unseren Auslieferungslägern nicht angenommen und auf Kosten des Absenders zurückgeschickt.

## 9. Entgegennahme

1. Angelieferte Gegenstände sind, auch wenn sie unwesentliche Anstände aufweisen, vom Besteller entgegenzunehmen.
2. Teillieferungen sind zulässig.

## 10. Haftung für Mängel

Für Mängel, zu denen auch das Fehlen zugesicherter Eigenschaften zählt, haftet der Lieferer wie folgt:

1. Alle diejenigen Teile oder Leistungen sind nach Wahl des Lieferers unentgeltlich nachzubessern, neu zu liefern oder neu zu erbringen, die innerhalb von 12 Monaten – ohne Rücksicht auf Betriebsdauer – vom Tage des Gefahrüberganges an gerechnet, infolge eines vor dem Gefahrübergang liegenden Umstandes, insbesondere wegen fehlerhafter Bauart, schlechten Materials oder mangelhafter Ausführung unbrauchbar werden oder deren Brauchbarkeit erheblich beeinträchtigt wurde. Die Feststellung solcher Mängel muss dem Lieferer unverzüglich schriftlich gemeldet werden.
2. Der Besteller hat die ihm obliegenden Vertragsverpflichtungen, insbesondere die vereinbarten Zahlungsbedingungen einzuhalten. Wenn eine Mängelrüge geltend gemacht wird, dürfen Zahlungen des Bestellers in einem Umfang zurückgehalten werden, die in einem angemessenen Verhältnis zu den auftretenden Mängeln stehen. Gehört jedoch der Vertrag zum Betrieb seines Handelsgewerbes, so kann der Besteller Zahlungen nur zurückhalten, wenn eine Mängelrüge geltend gemacht wird, über deren Berechtigung kein Zweifel bestehen kann.

## Allgemeine Hinweise

1. Mit Erscheinen dieses Kataloges werden sämtliche vorherigen Ausgaben ungültig.
2. Diese Ausgabe enthält nur KAISER Standardprogramme. Sonderprogramme und Entwicklungen auf Anfrage.
3. Weitere fremdsprachliche KAISER Kataloge auf Anfrage erhältlich.
4. Von uns durchgeführte technische Beratung erfolgt nach bestem Wissen und gilt als unverbindlicher Hinweis. Für die Auswahl geeigneter Installationsdosen, deren Werkstoffe und für den sicherheitstechnischen sachgemäßen Einbau bleibt der Errichter von Elektro-Installations-Anlagen verantwortlich.

Mai 2015

>> Irrtum und technische Änderungen vorbehalten.

Die aktuellen Liefer- und Zahlungsbedingungen finden Sie auf unserer Website unter: [www.kaiser-elektro.de](http://www.kaiser-elektro.de)

The version of the "General Terms and Conditions of Delivery of the ZVEI for Products and Services in the Electrical Industry" which is in force at the time in question shall apply as well as the following supplementary regulations of KAISER GmbH & Co.KG.

The place of performance shall be Schalksmühle and the place of jurisdiction Lüdenscheid.

## 1. Scope of deliveries or services

The written declarations of both parties shall carry equal weight in all matters relating to the scope of deliveries or services. If a contract has been concluded without such mutual declaration, either the written order confirmation from the supplier or service provider (hereinafter: supplier), shall be decisive. If such a document has not been issued, the written order from the purchaser shall be decisive.

Supplementary agreements shall only be valid if confirmed in writing.

## 2. Prices

The gross prices are recommended retail prices given in euros and exclusive of VAT. The prices of products made of brass are subject to certain fluctuations that are based on the relevant DEL listings. Our prices are based on a metal price quotation of Euro 150 of Ms 58. In case of any increase or reduction in these prices by more than 15 Euro, a five per cent surcharge or deduction shall be made for each 15 points. The calculation of any supplements due will be based on the DEL-price quotation for the date of receipt of the order by us.

## 3. Passing of risk

The risk shall pass to the purchaser, even when carriage freight paid delivery has been agreed:

1. When the delivery package has been brought to the shipping department or been collected, if assembly or mounting are not included in the delivery package. The goods shall be packaged with the utmost care. The goods shall be shipped in the manner deemed most appropriate by the supplier. At the request of the purchaser, the supplier shall insure the shipment against breakages and damage caused in transit or by fire.
2. Should the shipping, delivery, start or performance of installation or mounting be delayed at the request of the purchaser or for reasons for which he is responsible, the risk shall pass to the purchaser for the duration of the delay. However, the supplier shall be obliged to take out insurance cover if requested to do so by the purchaser. The costs for such cover shall be borne by the purchaser.

## 4. Retention of title

The goods shall remain the property of the supplier until the purchaser has satisfied all claims which the supplier can make on him under the terms of the business relationship. Prior to this time, pledging the goods or transfer by way of security shall be forbidden, and the goods may only be resold to the trade in the normal course of business subject to the proviso that the reseller receives payment from him customers. Any intervention costs shall be borne by the purchaser. If the combined value of the security interests of the supplier exceeds the value of all secured claims by more than 20%, the supplier shall release a corresponding portion of the security rights if so requested by the purchaser.

Should the purchaser breach the contract (in particular if it defaults on payment), the supplier shall be entitled to take back the goods under his ownership or, if necessary, enforce assignment or claims for return against third parties. All costs arising from the return and recycling of the goods shall be borne by the purchaser. Should the supplier take back goods to which still retains ownership rights, this shall not be interpreted as terminating the contract.

Should external warehousing facilities be used for goods from the supplier to which the supplier still retains ownership rights, the supplier must be informed of this. In such cases, the purchaser must conclude an individual agreement with the warehouse company in order to ensure that no liens will be executed on the goods to which the supplier still retains ownership rights. When such goods are delivered, the warehouse company must be informed in writing that the goods in question are the property of the supplier and are only being stored with the warehouse company on the proviso that it does not acquire a lien on the goods.

## 5. Terms of payment

1. Payment is to be made in euros and free of transaction charges to the designated account of the supplier.
2. The purchaser may only offset those claims that are uncontested or have been recognised by declaratory judgement.
3. Unless otherwise agreed, the purchaser shall have 30 days ./. to effect net payment counted from the date the invoice is issued.

## 6. Shipping costs

The prices shall apply for terms of delivery ex works for the acceptance of sealed shipping cartons for which no packaging costs are levied. If cartons are broken open, a surcharge of 5 EUR shall be levied per carton, irrespective of the value of the order.

## 7. Free delivery

Orders for sealed delivery within the Federal Republic of Germany which have a net value of 800 EUR or more shall be delivered free to the purchaser's address.

## 8. Returns

Goods may only be returned in exceptional circumstances and must first be approved by us. If we are not notified in advance, returns will not be accepted by our distribution warehouse and shall be returned at the expense of the consignor.

## 9. Acceptance

1. Even if they exhibit minor defects, the delivery items must be accepted by the purchaser.
2. Part-deliveries are permitted.

## 10. Liability for defects

The supplier shall be liable for defects as follows (if the delivered goods do not exhibit the warranted characteristics, this shall also be deemed a defect):

1. If parts or services become unserviceable or if their serviceability becomes seriously impaired within 12 months (regardless of the operation period) of the day of the passing of the risk, and if such unserviceability is due to factors which date from a time prior to the passing of the risk (in particular faulty construction, poor quality material or faulty workmanship), the supplier must either repair or replace the parts or perform the services again free of charge. Should such defects be discovered, the supplier must be informed in writing without delay.
2. The purchaser must comply with his contractual obligations, in particular the agreed terms of payment. If a complaint in respect of defects is lodged, the purchaser may withhold payments to a value considered appropriate in light of said defects. If, however, the contract concerns the operation of trade, the purchaser may only withhold payment if there is absolutely no doubt as to the legitimacy of the complaint that has been lodged.

## General information

1. The issue of this catalogue renders all previous editions null and void.
2. This edition only contains KAISER standard product ranges. Special product ranges and developments on request.
3. KAISER catalogues in other foreign languages are available on request.
4. We make every effort to ensure that technical advice given by us is correct. Such advice is given on a purely non-binding basis. The installer of electrical installation systems shall be responsible for the selection of suitable installation boxes, the materials for such boxes and performing installation in a safe manner.

May 2012

>> Subject to technical changes. No liability for errors.

The current term and conditions of delivery and payment can be found on our website: [www.kaiser-elektro.de](http://www.kaiser-elektro.de)

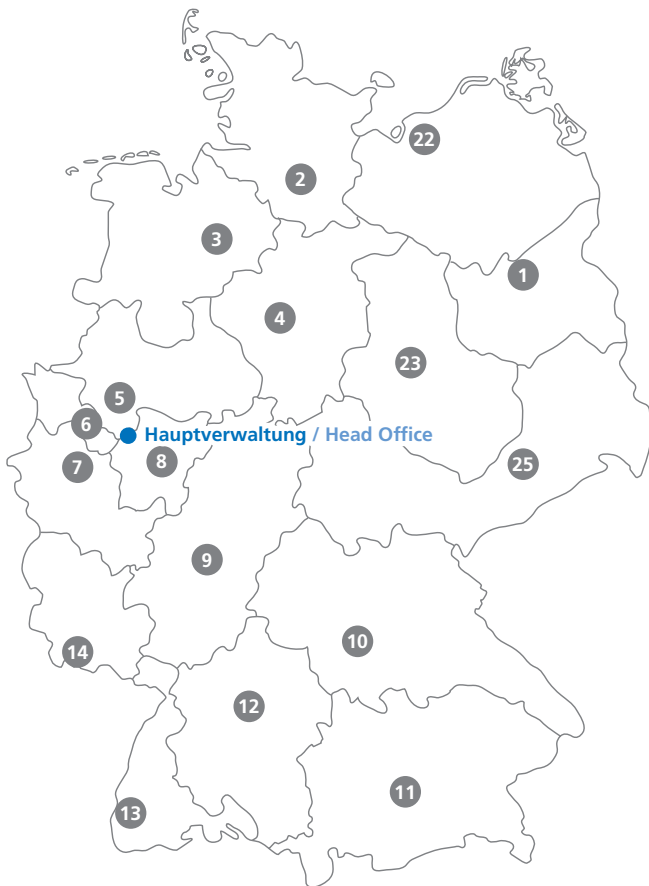

**1 Hauptverwaltung**  
KAISER GmbH & Co. KG  
Ramsloh 4  
58579 Schalksmühle  
Tel. 0 23 55.809.0  
Fax 0 23 55.809.21  
www.kaiser-elektro.de  
info@kaiser-elektro.de

**3 Bremen, Ostfriesland, Osnabrück**  
Steinbeck GmbH  
Elektro-Industriervertretung  
Carl-Benz-Str. 5 · 28816 Stuhr  
Tel. 04 21.87 40 57  
Fax 04 21.87 57 37  
www.steinbeck-online.de  
info@steinbeck-online.de

**1 Berlin, Brandenburg**  
Reiner Brajeska GmbH  
An den Dünen 3  
16515 Oranienburg  
Tel. 0 33 01.67 17.0  
Fax 0 33 01.70 03.25  
www.brajeska.de  
info@brajeska.de

**4 Niedersachsen**  
Detlef Sikora GmbH  
Lägenfeldstr. 7  
30952 Ronnenberg-Empelde  
Tel. 05 11.4 38 04.0  
Fax 05 11.4 38 04.48  
www.sikora.de  
hannover@sikora.de

**2 Hamburg, Schleswig-Holstein**  
Hans J. Möller  
Inh. Andreas Möller  
Wendenstr. 195 a  
20537 Hamburg  
Tel. 0 40.2 51 40.61  
Fax 0 40.2 51 46.14  
www.hjmoeller.de  
info@hjmoeller.de

**5 Westfalen\***  
beel & dolle  
Westfaliastr. 15  
44147 Dortmund  
Tel. 02 31.9 98 97.0  
Fax 02 31.9 98 97.50  
www.beel-dolle.de  
zentrale@beel-dolle.de

**10 Nordbayern**  
Jacob Haag Nachf. OHG  
Am Farrnbach 5  
90556 Cadolzburg  
Tel. 0 91 03.7 13 70.0  
Fax 0 91 03.9 16  
www.haag-elektro.de  
info@haag-elektro.de

**11 Südbayern**  
Alfons Brummer & Co. GmbH  
Felix-Wankel-Str. 4  
82152 Krailling  
Tel. 0 89.89 99 68.0  
Fax 0 89.89 99 68.23  
www.brummer.de  
info@brummer.de

**23 Sachsen-Anhalt, Nordthüringen\***  
Detlef Sikora GmbH  
Gewerbegebiet Süd 2  
39443 Staßfurt  
Tel. 03 92 66.931.0  
Fax 03 92 66.931.15  
www.sikora.de  
stassfurt@sikora.de

**25 Sachsen, Südthüringen**  
Industriervertretung  
Werner Ott GmbH  
Am Rossauer Wald 6  
09661 Rossau  
Tel. 03 72 07.405.0  
Fax 03 72 07.405.33  
www.iv-ott.de  
info@iv-ott.de

**6 Essen, Niederrhein**  
Schardt oHG  
Elektro-System-Technik  
Nachf. Thomas Schardt e.K.  
Bunsenstr. 10  
42551 Velbert  
Tel. 0 20 51.28 06.0  
Fax 0 20 51.28 06.29  
www.schardtohg.de  
info@schardtohg.de

**12 Württemberg**  
Frank Bossert  
Industriervertretungen  
Hofener Weg 17  
71686 Remseck/Stuttgart  
Tel. 0 711.57 76 69.60  
Fax 0 711.57 76 69.66  
www.bossert-weissinger.de  
info@bossert-weissinger.de

**7 Nordrhein**  
Brüning + Kahlen  
Industriervertretung GmbH  
Methweg 12  
50823 Köln  
Tel. 02 21.22 28 81.0  
Fax 02 21.22 28 81.50  
www.bkiv.de  
info@bkiv.de

**13 Südbaden**  
Fred Abel GmbH  
Im Ebnet 1  
79238 Ehrenkirchen-Kirchhofen  
Tel. 0 76 33.95 01.0  
Fax 0 76 33.95 01.30  
www.fredabel.de  
info@fredabel.de

**8 Olpe / Südwestfalen\***  
Ochsenfeld Handelsagentur  
Elektroindustriervertretung  
Hagener Str. 6  
57399 Kirchhundem-W.E.  
Tel. 0 27 64.2 15 69.0  
Fax 0 27 64.2 15 69.9  
www.ochsenfeld-ha.de  
zentrale@ochsenfeld-ha.de

**14 Saarland, Bezirk Trier, Kaiserslautern\***  
Albrecht Werner GmbH  
Service-Zentrum für Elektrotech.  
Am Felsbrunnen 5  
66119 Saarbrücken  
Tel. 06 81.8 83 55.0  
Fax 06 81.8 83 55.55  
www.werner-online.de  
info@werner-online.de

**22 Mecklenburg**  
Peter Frehse GmbH  
Industriervertretung  
Mitteldorf 5  
18239 Hasdorf  
Tel. 03 82 07.606.0  
Fax 03 82 07.606.22  
www.peterfrehse.de  
peterfrehse@t-online.de



**KAISER Service-Nummern für die Vertretergebiete:**  
**KAISER Service numbers for the agency regions:**

- 1 22 23 25 Tel. +49(0) 23 55.809.47  
Fax +49(0) 23 55.809.21
- 2 3 4 Tel. +49(0) 23 55.809.77  
Fax +49(0) 23 55.809.42
- 5 8 9 13 Tel. +49(0) 23 55.809.122  
Fax +49(0) 23 55.809.21
- 6 7 12 14 Tel. +49(0) 23 55.809.31  
Fax +49(0) 23 55.809.21
- 10 11 Tel. +49(0) 23 55.809.80  
Fax +49(0) 23 55.809.21

**Verkaufsleitung Inland | Domestic Sales Management**

Tel. +49(0) 2355.809.60 **Nord**  
Tel. +49(0) 2355.809.35 **Süd**

**Verkauf Ausland | Export Department**

Tel. +49(0) 2355.809.88 / .121/ .105  
Fax +49(0) 2355.809.40

**Technische Beratung | Technical Support**

Tel. +49(0) 2355.809.119  
technik@kaiser-elektro.de

**Produktmanagement | Technical Support**

Tel. +49(0) 2355.809.119  
Fax +49(0) 2355.809.42

---

**KAISER International**

**Deutschland | Germany**



**KAISER GmbH & Co. KG**

Ramsloh 4  
D-58579 Schalksmühle  
Tel. +49(0)23 55 . 809 . 0  
Fax +49(0)23 55 . 809 . 21  
www.kaiser-elektro.de  
info@kaiser-elektro.de

**Schweiz | Switzerland**



**AGRO AG | A KAISER COMPANY**

Korbackerweg 7  
CH-5502 Hunzenschwil  
Tel. +41(0)62.889.47.47  
Fax +41(0)62.889.47.50  
www.agro.ch  
info@agro.ch

**Belgien | Belgium**



**N.V. PLASTIC COLOR | A KAISER COMPANY**

Puursesteenweg 363  
B-2880 Bornem  
Tel. +32(0)3.899.40.40  
Fax +32(0)3.899.40.50  
www.helia-elektro.be  
info@helia-elektro.be

---

Weitere Bezugsquellen teilen wir Ihnen auf Anfrage mit. Bitte sprechen Sie uns an.

Bulgarien · Dänemark · Estland · Finnland · Frankreich · Griechenland · Großbritannien · Irland · Island · Italien  
Luxemburg · Kroatien · Lettland · Litauen · Niederlande · Norwegen · Österreich · Polen · Portugal · Rumänien  
Russische Föderation · Schweden · Slowenien · Slowakische Republik · Spanien · Tschechische Republik · Ukraine  
Ungarn · Weißrussland

We can provide other supply sources upon request. Please contact us.

Austria · Belarus · Bulgaria · Croatia · Czech Republic · Denmark · Estonia · Finland · France · Great Britain · Greece  
Hungary · Iceland · Ireland · Italy · Latvia · Lithuania · Luxembourg · Netherlands · Norway · Poland · Portugal  
Rumania · Russian Federation · Sweden · Slovakia · Slovenia · Spain · Ukraine



# Systeme und Lösungen für die professionelle Elektro-Installation.

## Systems and solutions for the professional electrical installation.



**Energieeffizienz.**  
Energy efficiency.



**Brandschutz.**  
Fire protection.

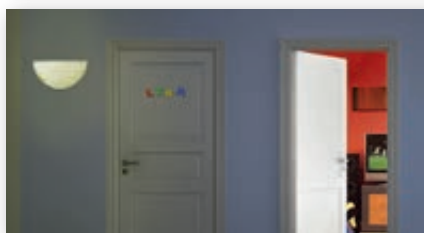

**Schallschutz.**  
Sound insulation.



**Strahlenschutz.**  
Radiation protection.



**Kabelverschraubungen.**  
Cable Glands.



### Technische Information und Beratung

Alle weiterführenden Informationen zu Produkten, Systemlösungen und Kommunikationsmedien finden Sie aktuell auf unserer Internetseite: [www.kaiser-elektro.de](http://www.kaiser-elektro.de)

Für ergänzende Fragen oder Informationen steht Ihnen unser technisches Beraterteam gerne zur Verfügung und freut sich auf das Gespräch mit Ihnen. KAISER Telefon: ++49(0)2355.809.119  
KAISER eMail: [technik@kaiser-elektro.de](mailto:technik@kaiser-elektro.de)

### Technical information and advice

You will find more information about products, system solutions and communication media on our website: [www.kaiser-elektro.de](http://www.kaiser-elektro.de)

For additional questions or information, please contact our technical staff. KAISER Tel.: ++49(0)2355.809.119  
KAISER Email: [technik@kaiser-elektro.de](mailto:technik@kaiser-elektro.de)

### KAISER GmbH & Co. KG

Ramsloh 4 · D-58579 Schalksmühle  
Tel. +49(0)2355.809.0 · Fax +49(0)2355.809.21  
[www.kaiser-elektro.de](http://www.kaiser-elektro.de) · [info@kaiser-elektro.de](mailto:info@kaiser-elektro.de)

