

## TR

TR 641 top2	641 0 100
TR 642 top2	642 0 100
TR 644 top2	644 0 100
TR 641 top2 RC	641 0 300
TR 642 top2 RC	642 0 300
TR 644 top2 RC	644 0 300

## Installation and operating instructions

Digital time switch with annual and  
astronomical program



Other languages are available at  
[www.theben.de](http://www.theben.de)

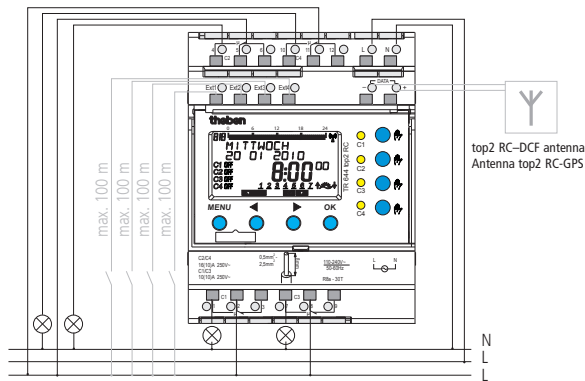

TR 644 top2 RC

# Contents

Basic safety instructions	3
Display and keys/operating instructions	4
Connection/installation	5
Overview of menu selection	6
Initial start-up	8
Time switch programs, astronomical programs	9

## PROGRAM

Program switching time again in the standard program	10
Request/change/delete switching time	12
Delete switching times	13
Pulse time programming	14
Programme cycle time	16
Standard and special programs	17

## SIMULATION 21

## TIME/DATE 22

## MANUAL 23

Manual and permanent switching	24
--------------------------------	----

<b>OPTIONS</b>	<b>25</b>
Set astro programs	26
4-channel extension module	29
Enter PIN code	29
External output	30
Time signal reception with top2 antenna	32
OBELISK top2 memory card	34
LAN module	35
Service address/Hotline	35
Technical data	36

# Basic safety instructions



**WARNING**

**Danger of death through electric shock or fire!**

➤ Installation should only be carried out by a qualified electrician!

- The device is designed for installation on DIN top hat rails (in accordance with EN 60715)
- Corresponds to type 1 BSTU in accordance with IEC/EN 60730-2-7
- Power reserve (8 years) is reduced if memory card is inserted (in battery operation)

## Designated use

- The time switch can be used for lighting, bell systems, ventilation etc.
- Only use in enclosed dry spaces (device); antenna is installed in the open-air

## Disposal

Dispose of device and batteries separately in an environmentally sound manner

## Screen and keys

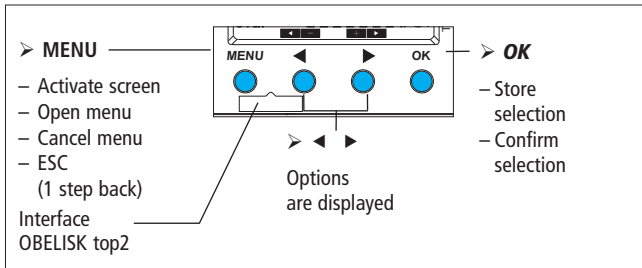
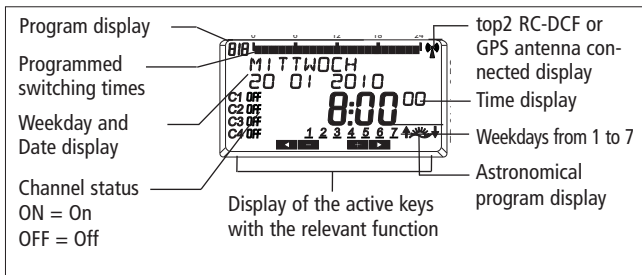

## Operating instructions

### 1. Read text lines

Text represents query

### 2. Make a decision

#### YES

Confirmation

Press  
**OK**

#### NO

Amend/  
change

Press  
◀ ▶

## Connection/installation

### WARNING



#### Warning, danger of death through electric shock!

- Must be installed by qualified electrician!
- Disconnect power source.
- Cover or shield any adjacent live components.
- Ensure device cannot be switched on!
- Check power supply is disconnected.
- Earth and bypass.

#### Connect cable

- Strip cable by 8 mm (max. 9 mm).
- Insert cable at 45° in the open terminal (2 cables per terminal position possible).
- Only with flexible wires: To open the plug-in screwless terminal, press screwdriver downwards.

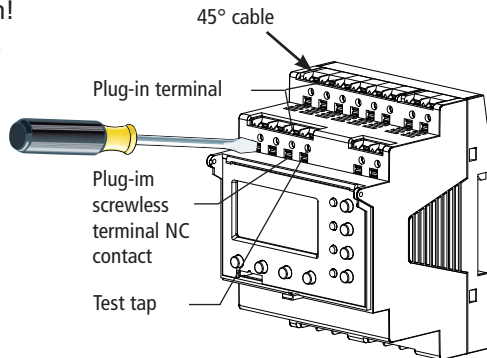

# Overview of menu selection

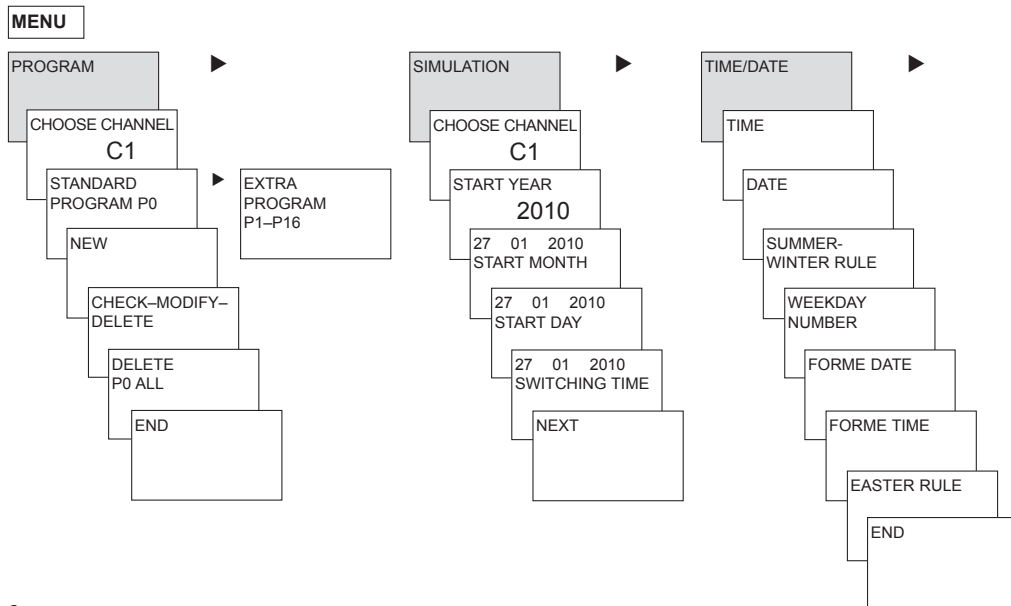



# Initial start-up

## Set date, time and summer/ winter time rule

- Press required key and display follows on screen (see figure).

You can connect the **antenna top2 RC-DCF** (907 0 410) or the **antenna top2 RC-GPS** (907 0 610) in order to synchronise the time switch via the DCF/GPS time signal.

With correct reception the synchronisation occurs automatically after a few minutes.

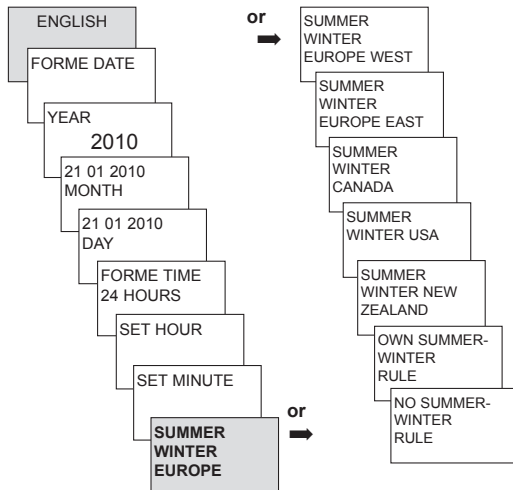



## Time switch programs, astronomical programs

With the digital 365-day time switch TR 641 top2 (1-channel time switch), TR 642 top2 (2-channel time switch), TR 644 top2 (4-channel time switch) the time switch or astro programs can be programmed and switched optionally for each channel.

Time switch programs	Astro programs
<p><b>Time switch function</b></p> <ul style="list-style-type: none"> <li>– 1 <b>Standard program</b> P0 (Weekly program with switching times, pulse and cycle times)</li> <li>– 16 <b>Extra programs</b> consisting of:               <ul style="list-style-type: none"> <li>14 Extra programs P1–P14 (Weekly programs with switching times, pulse and cycle times with different adjustable date ranges (fixed date range, date dependent on Easter etc.), with extra program P15 (permanently on) and extra program P16 (permanently off) (with adjustable date ranges)</li> </ul> </li> </ul>	<p>The astro function can be activated instead of the time switch function for each channel</p> <ul style="list-style-type: none"> <li>– 1 <b>Astro standard program</b> P0 (with fixed on/off times, weekly program)</li> <li>– 16 <b>Extra programs</b> consisting of:               <ul style="list-style-type: none"> <li>14 Astro extra programs P1–P14 (with fixed on/off times, weekly program) with different adjustable date ranges (fixed date range etc.), with extra program P15 (permanently on) and extra program P16 (permanently off) (with adjustable date ranges)</li> </ul> </li> </ul>

A channel can be defined as an astro channel in: MENU → Options → Astro → astro settings → choose channel → change to astro program

## Time switch program

### Program switching time again in the standard program

**Example: Switch on sports hall lighting from Mon–Fri, 7:30 to 12:00 hrs**

- Press **MENU**. **PROGRAM** is displayed.
- Confirm by pressing **OK**. **CHOOSE CHANNEL** is displayed.
- Confirm **CHANNEL 1** by pressing **OK**. **STANDARD PROGRAM P0** is displayed.
- Confirm by pressing **OK**. **NEW** is displayed.
- Confirm by pressing **OK**. **SWITCHING TIME** is displayed.
- Confirm by pressing **OK**. Select **ON** (for switch-on times).
- Confirm by pressing **OK**. The display shows **SET HOUR**.
- Use the + or – keys to enter hour, minute, (07:30) and confirm by pressing **OK**. **EVERY DAYS** is displayed. Press ► to select **MONDAY**.
- Confirm by pressing **OK**. **COPY** is displayed.
- Confirm by pressing **OK**. **ADD TUESDAY** is displayed.
- Confirm by pressing **OK** and also confirm the days Wed, Thurs, Fri by pressing **OK**.
- Continue with ► to **SAVE** is displayed. Confirm by pressing **OK**.

Repeat all steps for the switch-off time however instead of selecting ON with ► select OFF and enter 12:00 for hour and minute.

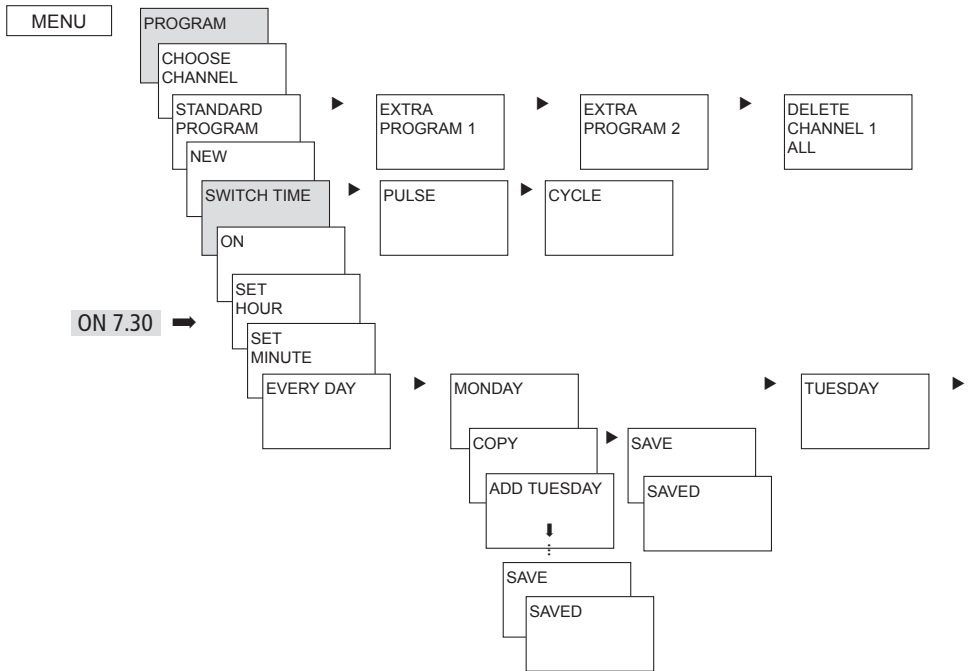

## Request/change/delete switching time

- Press **MENU**. **PROGRAM** is displayed.
- Confirm by pressing **OK**.
- Confirm **CHANNEL 1** by pressing **OK**.
- Confirm **STANDARD PROGRAM P0** by pressing **OK**.
- Use **▶** to select **CHECK-MODIFY-DELETE**.
- Confirm by pressing **OK**.
- Confirm **SWITCH TIME** by pressing **OK**. The first of the entered switching times is displayed.
- Confirm by pressing **OK**. **NEXT** is displayed.

Change or delete individual switching times

- Press **▶** to select **MODIFY** (or **DELETE**).
- Confirm by pressing **OK**. The display shows **CHANGE HOUR**.
- Use the **+** or **-** keys to enter hour and minute and confirm by pressing **OK**.

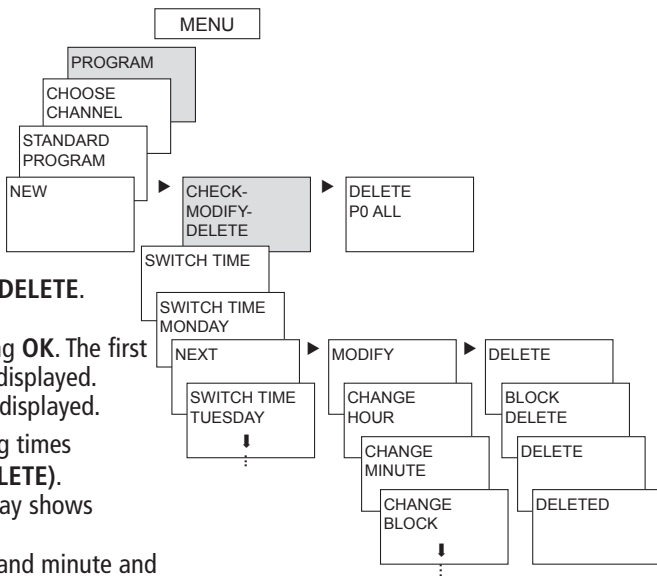

## Delete all switching times in the standard program

- Press **MENU**. **PROGRAM** is displayed.
- Confirm by pressing **OK**.
- Confirm **CHANNEL 1** by pressing **OK**. **STANDARD PROGRAM P0** is displayed.
- Confirm by pressing **OK**.
- Use **▶** to select **DELETE P0 ALL**.
- Confirm by pressing **OK**. The display shows **CONFIRM DELETE**.
- Confirm by pressing **OK**. The display shows **DELETED**.

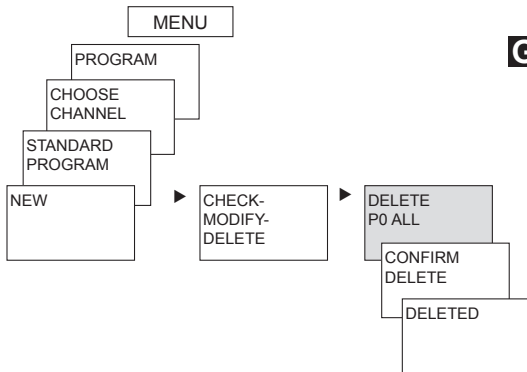

# Pulse time programming

**Example: Switch on pause signal on Monday 8:05 hrs for 5 sec**

- Press **MENU**. **PROGRAM** is displayed.
- Confirm by pressing **OK**. **CHOOSE CHANNEL** is displayed.
- Confirm **CHANNEL 1** by pressing **OK**. **STANDARD PROGRAM P0** is displayed.
- Confirm by pressing **OK**. **NEW** is displayed.
- Confirm by pressing **OK**. **SWITCH TIME** is displayed.
- Select **PULSE** by pressing **▶**.
- Confirm by pressing **OK**. **ON** is displayed.
- Confirm by pressing **OK**. The display shows **SET HOUR**.
- Use the + or – keys to enter hour, minute, second (8:05) and confirm by pressing **OK**. **PULSE LENGTH** is displayed.
- Use the + or – keys to enter the duration of the pulse in minutes and seconds (5 sec). **EVERY DAY** is displayed. Press **▶** to select **MONDAY**.
- Confirm by pressing **OK**. **EVERY DAY** is displayed.
- Press **▶** to select **MONDAY**. Confirm by pressing **OK**.
- **COPY** is displayed. Press **▶** to select **SAVE**.
- Confirm by pressing **OK**.

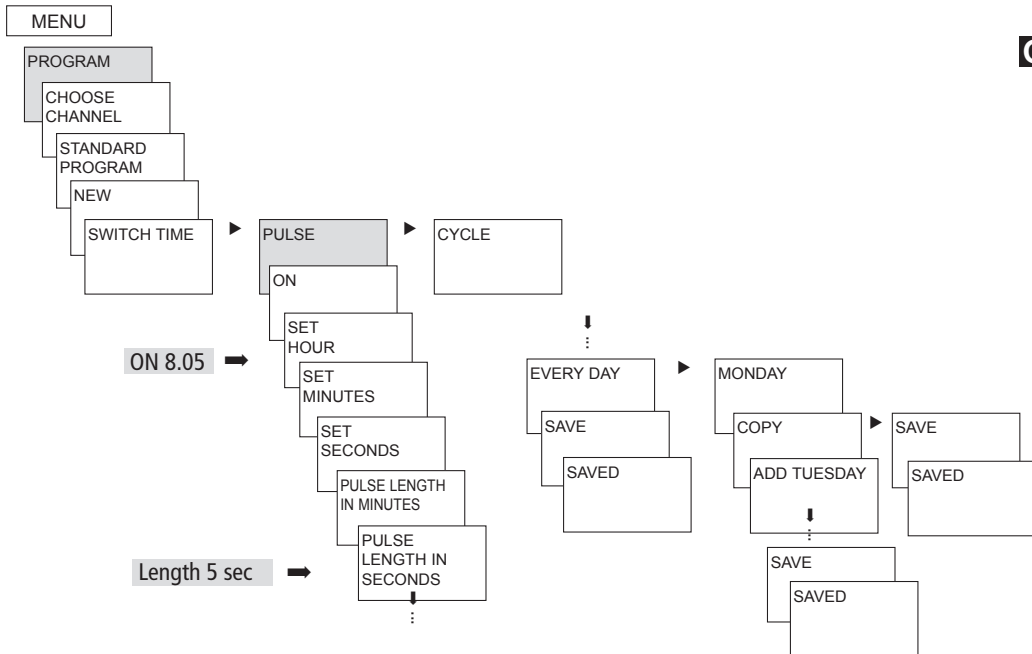

# Programme cycle time

In addition to switch-on and switch-off times (switching time) and short time pulses (pulse) cycle times (cycle) can also be programmed. The pulse length (+ pulse pause) is limited to 17 hrs, 59 min, 59 sec

- Cycle times refers to cyclically repetitive time functions such as fan controls, urinal rinses etc.

**Example:** Switch on water rinsing Monday from 8:00 to 20:30 hrs every 15 min for 20 sec (8:00<sup>00</sup>–8:00<sup>20</sup> On; 8:15<sup>00</sup>–8:15<sup>20</sup> On; 8:30<sup>00</sup>–8:30<sup>20</sup> On etc.)

## Cycle programming

- Start cycle: Monday 8:00 hrs
- Pulse length: 20 sec
- Pause length: 14 min 40 sec
- Cycle end: Monday 20:30:00 hrs



## Standard program and extra programs

- The standard program P0 (weekly program with switching times, pulse and cycle times or astronomical program) is always active however has the lowest priority and can be superimposed by the extra programmes P1–P16.
- In extra programs the following is valid: the higher the number the higher the priority. The extra program 16 has the highest, the extra program 1 the lowest priority.
- Each extra program has an arbitrary number of date ranges available. A extra program becomes active when at least one date range has been set and is not superimposed by another extra program with a higher priority during this period. At the start and end of each date range the hour can also be entered to ensure that the changeover to the respective extra program occurs on each complete hour.
- The following date ranges can be set in parallel:
  - Fixed date (once)
  - Fixed date each year
  - Easter rule or the Orthodox Church rule (81 days before ... 174 days after Easter)

- Chinese New Year (20 days before ... 20 days after the Chinese New Year)
- Date with serial pattern (Time limit series): Start and end are set and the start repeated according to an adjustable number of days (at the latest after 200 days)
- Weekday rule (e.g. every 3rd Wednesday in September)

## Extra programs

### Examples of calendar-dependent date ranges:

#### – Fixed date range:

Start on 02.04.2010 at 16:00 hrs, End on 24.04.2010 at 10:00 hrs

#### – Annually recurring date range

Christmas: Start every year on 24.12. at 18:00 hrs, End on 26.12. at 23:00 hrs

#### – Easter-dependent date range

Whit Sunday and Monday: Start every year: 49 days after Easter at 0:00 hrs,  
End: 51 days after Easter at 0:00 hrs

#### – Date range dependent on the Chinese New Year

Start each year 1 day before the Chinese New Year. New Year, End 5 days after

- Date with **serial pattern (Time limit series)**  
as from November 2010 to be carried out successively every 2nd week  
Start on Monday 01.11.2010 at 0:00 hrs; End on Monday 08.11.2010 at 0:00 hrs,  
repeat start after 14 days
- **Date dependent on the weekday etc.**  
each month on the 1st weekend from Saturday 06:00 hrs to Sunday 18:00 hrs;  
start 1st Sunday each month at 06:00 hrs, duration 36 hours
- **Public holiday settings**  
With the help of the PC software OBELISK top2 the public holidays in a country in the set can  
be set together, individually processed and transferred to the time switch with the memory card  
OBELISK top2 as date ranges.
- **Extra program P1-14 Time switch channel**
  - Active in the programmed date ranges
  - Switch timings, pulse and cycle times can be entered as week programs
- **Extra program P1-14 Astronomical channel**
  - Active in the programmed date ranges
  - Astronomical times are active (calculated sunrise and sunset times)

- Fixed switch-offs (e.g. nighttime interruption) and switch-ons can also be entered as weekly program in order to superimpose the astronomical times entirely or partially.

**Example:** The standard program switches on the street lighting in dependence of the astro times. A nighttime interruption is programmed from 23:00 hrs to 04:00 hrs.

Extra program 1 is active within the date range from April 30, 12:00 hrs until May 12:00 hrs. To ensure that the street lighting remains switched on all night no nighttime interruption is programmed in the extra program 1.

- **Extra program P15**

- Function: **Permanently ON**
- Active in the programmed date ranges

- **Extra program P16**

- Function: **Permanently OFF**
- Active in the programmed date ranges

**Example:** The car park lighting is switched on and off at fixed times or Monday to Friday according to astro times. The extra program P 16 Permanently Off ensures that the car park lighting is not switched on on any public holidays.

## SIMULATION

During the simulation it is a channel-related total request. All channel switching entered (standard and special program, switching times, pulse and cycle programs) are displayed in the time sequence in which they are applied.

In the case of an astronomical channel all astronomical switch-ons and fixed switch-ons / switch-offs are displayed in their time sequence.

- Press **MENU** using ► select **SIMULATION** and follow the indications on the display in order to request all the switchings applied (see figure).

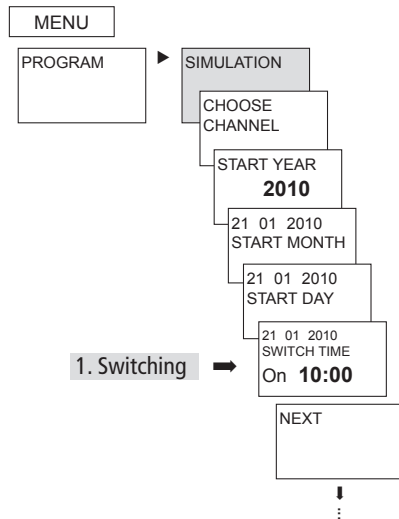

# TIME/DATE

In the menu TIME/DATE the TIME, DATE, SUMMER WINTER RULE, WEEKDAY NUMBER, EASTER RULE etc. can be entered/changed in the submenus.

➤ Press **MENU** using ► select **DATE/TIME** and follow the indications on the display.

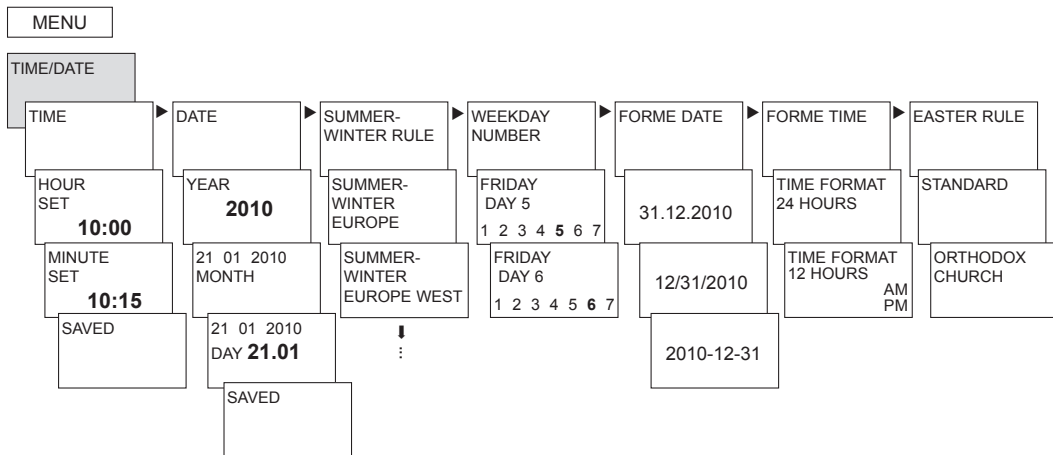

# MANUAL

In the MANUAL menu manual switch functions are applied. In the submenus MANUAL, PERMANENT ON/OFF, TIMER SHORT TERM CIRCUIT, HOLIDAY, RANDOM as well as ACTIVATE EXTRA PROGRAM the manual switching can be activated/programmed.

➤ Press **MENU** using ► select **MANUAL** and follow the indications on the display.

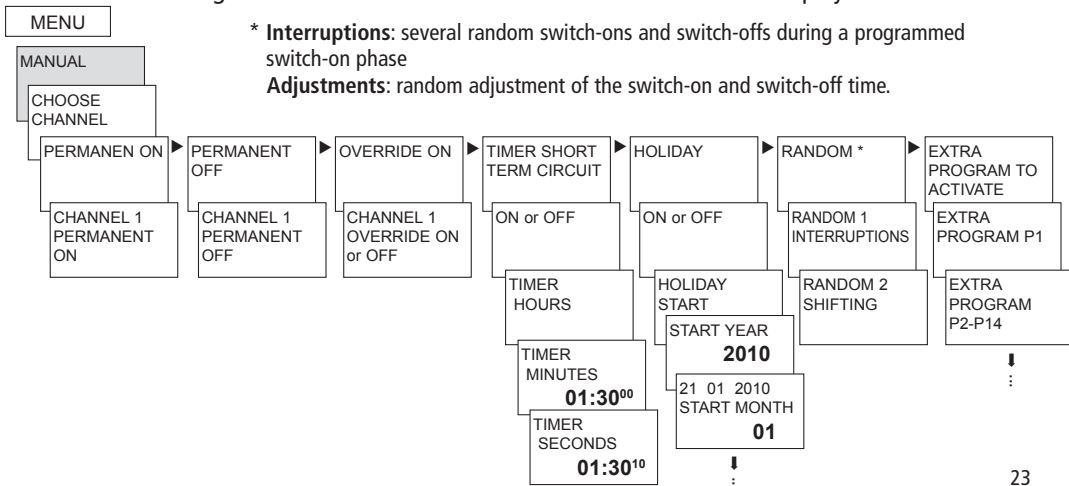

# Manual and permanent switching

Manual and permanent switching can be set using the menu in **MANUAL** or in normal mode (automatic screen) by direct keystroke (see figures).

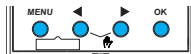

TR 641 top2 RC



TR 642 top2 RC

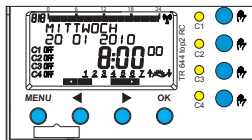

TR 644 top2 RC

## Activate manual switching

- Briefly press key.

## Activate permanent switching

- Press key for 2 sec.

## Cancel manual /permanent switching

- Briefly press key again.

### Manual switching

Reversing the channel status to the next automatic or programmed switching.

### Permanent switching

As long as a permanent switching (on or off) is activated, the programmed switching times are ineffective.



# OPTIONS

In the menu OPTIONS the submenus ASTRO, EXTERNAL INPUT, OPERATING HOUR, LANGUAGE, PIN, LCD ILLUMINATION, EXTENSION MODULE (only for RC devices), FACTORY SETTINGS as well as INFO can be requested.

➤ Press **MENU** using ► select **OPTIONS** and follow the indications on the display.

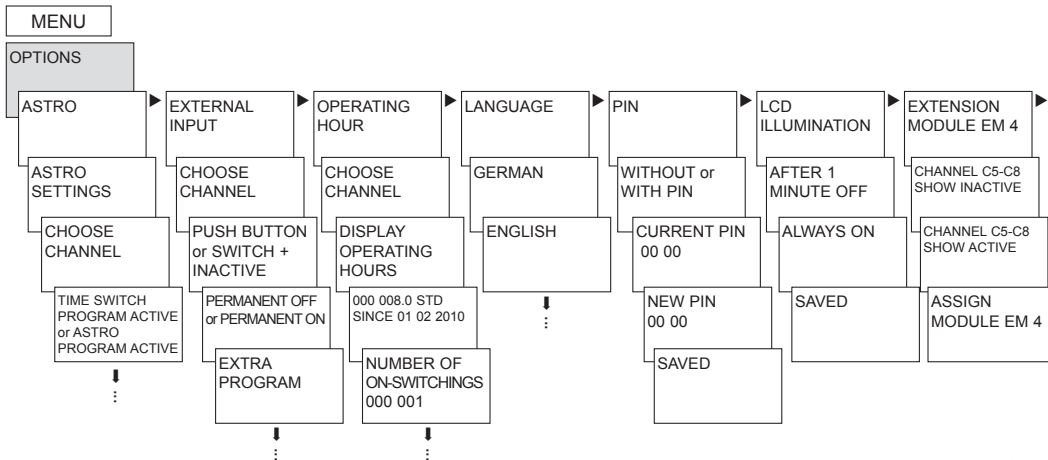

## Set ASTRO program

... if a time switch program is active.

- Press **MENU** using ► select **OPTIONS** and follow the instructions on the display.

You will automatically be taken to the setting for the POSITION data (COUNTRY or COORDINATES input) and the ASTRO SETTINGS (OFFSET and ASTRO MODE).

If an ASTRO program is activated on a channel you can change the channel back to the time switch program.  
Programmed switching times are deleted when changing to the astro program.

... if astro times are active.

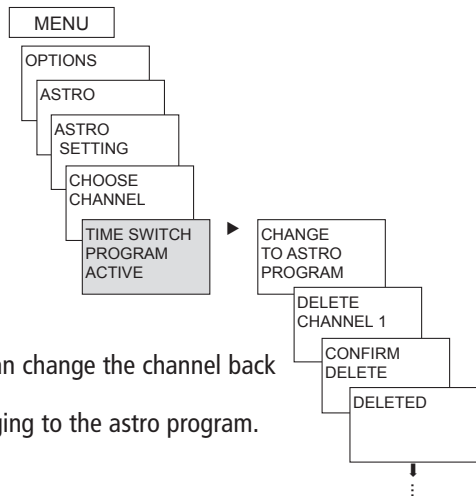
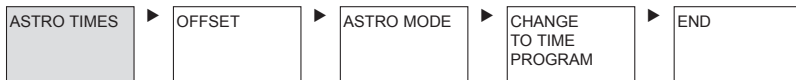

In the **OPTIONS** submenu **ASTRO** it is possible – after a channel has been changed to astro program – to request or change astro times, offset, astro mode as well as position (location). If a channel is set as an astro channel the symbol is displayed  and the astro times are accessed after the channel selection.

- **ASTRO TIMES**

Astro time display (sun rise and sunset as well as offset) for the current day

- **OFFSET**

With the offset (adjustment value) the calculated astro times can be adjusted by max. +/- 2 hrs. This means that the astro on and off switching time can be adapted to local conditions (e.g. mountains, high buildings etc.) or to personal requirements.

- **ASTRO MODE**

– Evenings **on**, mornings **off**

At sunset it switches **on**, at sunrise it switches **off** (e.g.: street lighting)

– Evenings **off**, mornings **on**

At sunset it switches **off**, at sunrise it switches **on** (e.g.: Terrarium)

– **Astro pulse**: Evenings and mornings, only mornings or only evenings; pulse duration max. 59 min, 59 sec)

- **POSITION**

- setting of the location using **coordinates** (longitude/latitude, time zone) or **country/city**
- With the memory card OBELISK top2 up to 10 more cities (= **Favourites**) can be added
- Own astro table (with OBELISK top2-program)
- Automatic setting if antenna top2 RC-GPS is connected (only for RC devices)

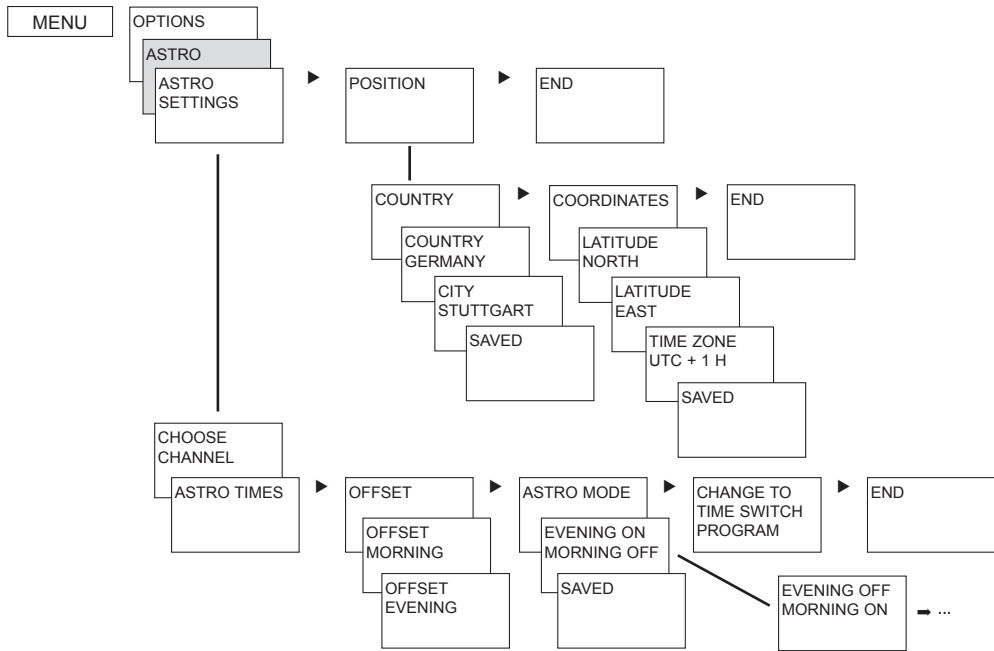

## 4-channel extension module EM 4 top2

With the module EM 4 top2 (649 0 104) the 365-day time switch (only for RC devices) can be updated to 4 channels.

The module must be registered in the menu **OPTIONS** in the time switch (see operating manual for the module EM 4 top2).

### Enter PIN code

The **PIN-Code** is set in **OPTIONS** via the menu. If you have forgotten your PIN call the Theben Hotline.

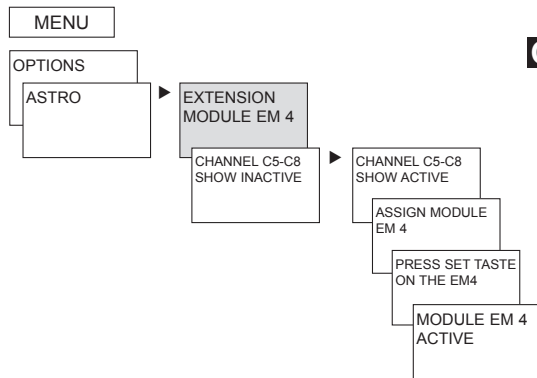

## EXTERNAL OUTPUT

For each channel an **EXTERNAL INPUT** (see figure) can be set with different functions.

➤ Press **MENU** using ► select **EXT INPUT** and follow the indications on the display.

3 submenus can be selected: Inactive, push button (function), switch (function)

- **INACTIVE:** The external input has no function
- **PUSH BUTTON:** Manual (manual switching), timer (Countdown timer) and staircase light (via the external input the staircase light time switch function can be applied) can be selected.
- **SWITCH:** Permanently on, permanently off or special program (via the external input one of the 14 special inputs can be selected, started and ended by pressing the switch) can be selected.

### Note:

If a function is activated via an external push button or switch, **EXTERNAL** is displayed.

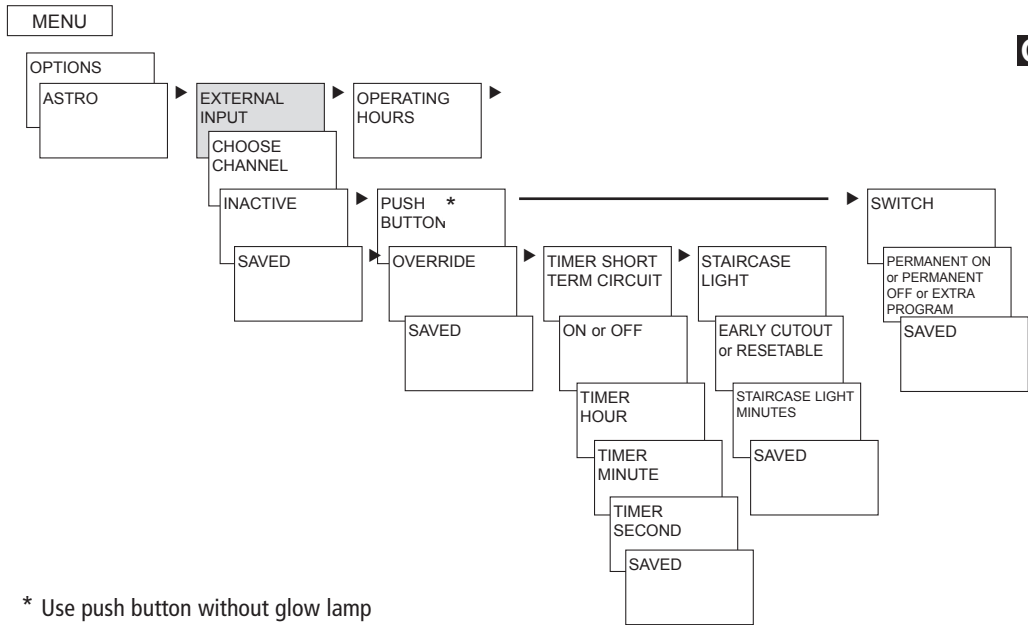

\* Use push button without glow lamp

## Time signal received with suitable antenna top2 RC-DCF or antenna top2 RC-GPS

- Only use the **antenna top2 RC-DCF** (907 0 410) or **antenna top2 RC-GPS** (907 0 610) for the 365-day time switch.
- By connecting the antenna top2 RC-DCF or GPS the time switch can be automatically synchronised via the DCF or GPS time signal. The time zone can be individually set. Upon receipt of GPS data the GPS coordinates are also transferred to the time switch.
- After connection to the power supply or resetting there is change to the automatic display after 70 sec, as soon as the DCF or GPS time signal has been received.
- **Align antenna top2 RC-DCF** in the direction of Frankfurt am Main (best reception is achieved by installing on the outside of the building).
- **Follow advice in the top2 RC-DCF or GPS antenna operating instructions.**



- NOTE**
- When connecting ensure correct polarity.
  - Lay separate cable for antenna power supply.
  - Observe maximum cable length of 100 m.
  - Align the radio antenna so that the green LED flashes once a second.
  - A maximum of 5 365-day time switches can be connected to one antenna.

## Setting time zones

After successful synchronisation, the time zone can be altered in the TIME/DATE menu option.

- In the submenu TIME (display: ALTER HOUR) correct the applicable local time (time zone).

**Reception of the DCF-/GPS time signal:**  
**Display:** 20 01 2010 RC (Radio Control)

**No reception of the DCF-/GPS time signal:**  
**Display:** e.g. 20 01 2010 Y

**No connection to antenna:**  
**Display:** 20 01 2010

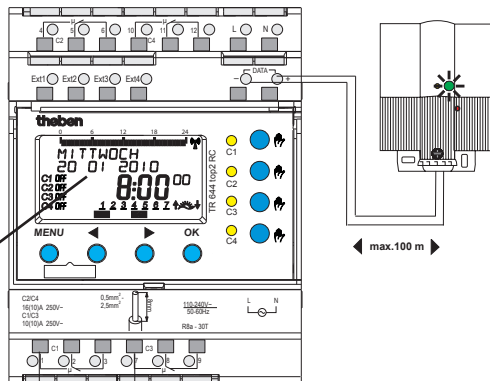

## OBELISK top2 memory card

### Use memory card (see fig.)

- Insert memory card in the time switch.
- Read / read out saved switching times and device settings in the time switch or start Obelisk program.
- Remove memory card OBELISK top2 (No. 907 0 404) after copying and store in the cover.
- Avoid mechanical stress or dirtying with other storage/transport methods.

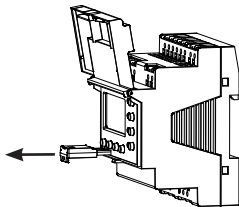

### Copy OBELISK → Time switch

This copies the switching program (all standard and special programs) and optionally all time switch (e.g. Position, offset, external input, time format etc..) from the memory card in the time switch.

### Copy TIME SWITCH → OBELISK

This copies all switching programs and settings from the time switch to the memory card

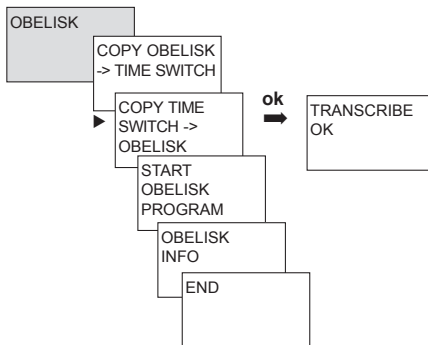

## LAN module EM LAN top2

With the LAN module EM LAN top2 (649 0 900) remote access to the 365-day time switch is possible via a LAN. OBELISK top2 data (switch programs and device settings) can be read / read out via a remote connection using the LAN top2 software.

Furthermore, using the remote access the switching status on the 365-day time switch can be read and modified, the time controlled etc.

The 365-day time switch cannot be operated during the LAN access (also see the operating manual for the module EM LAN top2).

## Service address/Hotline

### Service address

**Theben AG**

Hohenbergstr. 32

72401 Haigerloch

GERMANY

Telephone +49 (0) 74 74 6 92 0

Fax +49 (0) 74 74/6 92-150

### Hotline

Telephone +49 (0) 74 74 6 92 -369

Fax +49 (0) 74 74/6 92-207

hotline@theben.de

**Addresses, telephone numbers etc.**

**[www.theben.de](http://www.theben.de)**

The current OBELISK top2 PC software and the online version of the operating manual (with time zone map) are available at

**[www.theben.de](http://www.theben.de)**

## Technical Data

	641 0 100	641 0 300	642 0 100	642 0 300	644 0 100	644 0 300
Operating voltage / Frequency	110 – 240 V~, -15 %/+10 %, 50 - 60 Hz					
Power consumption (typ.)	1,3 W	2,0 W	1,7 W	2,5 W	2,6 W	3,6 W
Standby	0,6 W	1,2 W	0,6 W	1,2 W	0,5 W	1,3 W
Data output	phase independent (not suitable for switching SELV)					
DATA output SELV - Safety Extra-Low Voltage	---	yes	---	yes	---	yes
Contact / Gap / Contact material	two way switch / <3 mm ( $\mu$ ) / AgSnO <sub>2</sub>					
Switching capacity max. cos $\phi$ = 1	16 A, 250 V~				C1+C3: 10A, 250 V~ C2+C4: 16 A, 250 V~	
Switching capacity max. cos $\phi$ = 0,6	10 A, 250 V~					
Switching capacity min.	10 mA/230 V AC bzw. 100 mA/12 V AC/DC					
Incandescent / Halogen lamp load 230 V~ (120 V~)	2600 W (1300 W)				C1+C3: 2300 W (1150 W) C2+C4: 2600 W (1300 W)	
Fluorescent lamp load 230 V~ (120 V~) - uncorrected, series corrected - parallel correction	2300 VA (1150 VA) 1200 VA; 130 $\mu$ F (600 VA; 65 $\mu$ F)					
Compact fluorescent lamps 230 V~ (120 V~)	37 x 7 W; 30 x 11 W; 26 x 15 W; 26 x 20 W; 23 x 23 W (18 x 7 W; 15 x 11 W; 13 x 15 W; 13 x 20 W; 11 x 23 W)					
Permissible ambient temperature	-30 °C ... +55 °C				typ. -30 °C ... +45 °C, temporary +55 °C	
Protection class	II in accordance with EN 60730-1 subject to designated installation					
Protection rating	IP 20 in accordance with EN 60529					
Time accuracy	$\pm$ 0.5 s / day at 20 °C					
Power reserve	8 years (lithium call)					
Pollution degree	2					
Power supply on the DATA bus (maximum power on the DATA bus: 500 mA)	---	100 mA	---	100 mA	---	100 mA