

theben

Fan Coil Actuator EIB KNX

FCA 1

492 0 200

310 217 01

- ✱ LED on = cooling valve is open
LED flashes when the cooling valve is to be opened but the heating valve has not yet been closed.
- ⋮ LED on = heating valve is open
LED flashes when the heating valve is to be opened but the cooling valve has not yet been closed.
- C1** LED for additional relay
- Test** LED Test **On**, when test mode is active (can be disabled by the application)

1.0 Designated use

The fan coil actuator FCA 1 is a series device and suitable for connection to a Bus EIB/KNX. The actuator FCA 1 is suitable for 2-pipe and 4-pipe systems. It controls up to 3 fan stages as well as 2 or 3-point heating and cooling valves. An additional relay enables the actuation of an electrical heater or a cooler bank. The actuator FCA 1 features 2 inputs for floating contacts, e.g. window contact and condensate monitoring (the window contact input can be reconfigured as a temperature sensor input). The actuator is suitable for dry rooms only.

2.0 Basic safety instructions



WARNING

Danger of death through electric shock or fire!

- Installation should only be carried out by professional electrician!

The regulations and instructions in the ZVEI/ ZVEH Handbook for building systems technology must be observed to ensure that the bus line is installed and the devices are commissioned in a professional manner.

3.0 Description

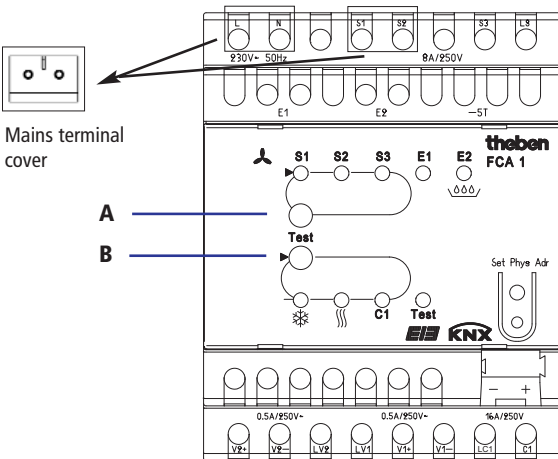

After connecting, place the enclosed mains terminal covers onto the connection screws of the mains terminals, as the connecting cables routed over them may carry safety extra-low voltage (SELV).

- S1-S3** LEDs for displaying the fan stage
- E1** LED On = contact closed
LED flashing = sensor break/condensate
- E2** LED illuminated = condensate
- A** Test key for the fan stages (fan key)
- B** Test key for the valves and additional relay C1

4.0. Electrical connection

- WARNING**
- Danger of death through electric shock!**
- Must be installed by professional electrician!
- Connect power source.
- Cover or shield any adjacent live components.
- Ensure device cannot be switched on!
- Check power supply is disconnected!
- Earth and bypass!

Example: 2-point valve and additional stage Heating and cooling

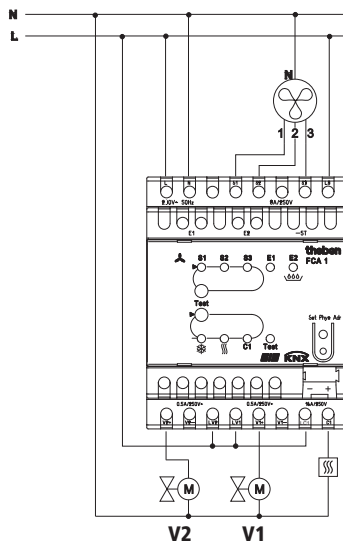

**V1 = heating valve
V2 = cooling valve**

Example: 2-point valve and additional stage cooling only/heating only

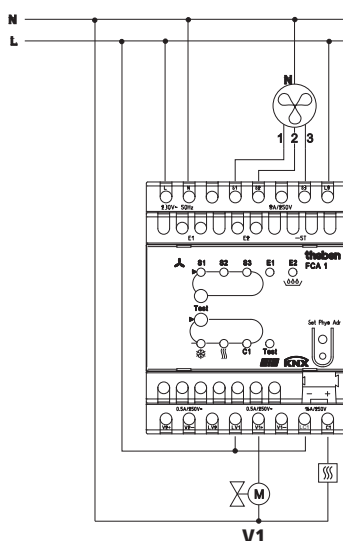

**V1 = heating valve
or cooling valve**

Example: 3-point valves and additional stage Heating and cooling

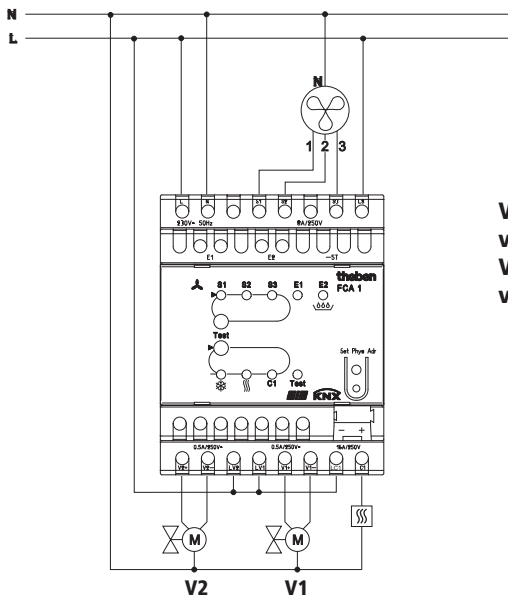

V1 = heating valve
V2 = cooling valve

Example: 3-point valves and additional stage cooling only/heating only

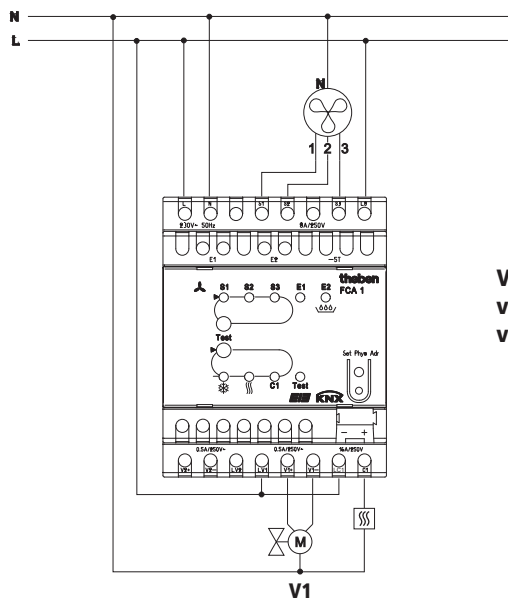

V1 = heating valve or cooling valve

Example: Inputs 1 and 2 connection

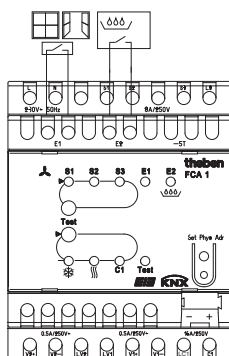

5.0 Response to mains/bus failure

Information in the event of power failure

In case of power failure, all relays drop out, irrespective of the software configuration. This means that the power circuit is interrupted.

Mains failure detection for 3-point valves

If the mains voltage fails while positioning a 3-point valve, the valve remains in an unknown position after the power is reinstated. The mains voltage is therefore monitored at terminals L and N. When the mains is reinstated, the valve is first closed completely and then moved into the correct position.

Important: This function is possible only if device and valve are connected to the same power circuit.

6.0 Installation

Lock the module onto the distributing bus bar.

Connection:

- Ensure correct polarity of the bus connection terminal.
- Close the actuator as shown on the wiring diagram in
- Chapter 4.0.

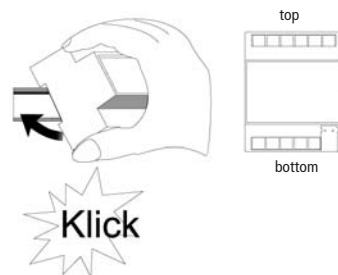

7.0 Start-up

Test mode (for start-up only)

- The test mode is used to check the system, e.g. during start-up or trouble shooting.
- In this mode, the valves and the fans can be set by hand as required using the appropriate keys.
- Inputs E1 and E2 can also be tested.



Important information about the test mode:

- Both the control and the bus telegrams are ineffective.
- All settings are possible without any restrictions.
- Please refer to the Handbook for detailed functional descriptions.

In test mode, all fan stages and the two valves are supplied with power in sequence, irrespective of the parameters.

- The valves and the fan are actuated until they are switched off again by hand.
- Condensate alarm is not taken into account.
- Avoid non-permitted operating states (e.g. heating and cooling valves open at the same time or a valve continuously supplied with power).

Activating test mode (no application):

- Following Reset, i.e. after a download or applying the bus voltage, the **Test LED** flashes for 1 minute; the **FCA 1 is then in normal mode**.
- Without application program: the LED flashes permanently.
- As long as the LED flashes, test mode can be started by pressing test key B   or test key A : The FCA 1 switches to test mode and the LED is permanently illuminated.

Fan control:







- **Press test key A** repeatedly; one stage after the other will be enabled.

Controlling valves/switching additional relay:

- **Press test key B** repeatedly; the required valve or the additional relay C1 can then be selected as required.

The active function and the output status can be displayed by the corresponding LED, see below.

Status display, heating and cooling valve in test mode

LED status	Meaning	for 3-point valves	for 2-point valves
 OFF	Valve is not actuated	Valve is not actuated	Valve is not actuated
 ON	Valve is opened (V2+)	Valve is opened (V2+)	Valve is opened (V2+)
 Flashing	Valve is closed (V2-)	Valve is closed (i.e. no longer actuated)	Valve is closed (i.e. no longer actuated)
 OFF	Valve is not actuated	Valve is not actuated	Valve is not actuated
 ON	Valve is opened (V1+)	Valve is opened (V1+)	Valve is opened (V1+)
 Flashing	Valve is closed (V1-)	Valve is closed (i.e. no longer actuated)	Valve is closed (i.e. no longer actuated)

Check temperature sensor:

- If a temperature sensor is connected to input E1, and E1 is configured accordingly in the application, the measured room temperature is sent by object 14.
- A sensor break or short-circuit in the sensor line are signalled by the value – 60 °C (LED E1 flashes).

Checking window contacts:

- If a window contact is connected to input E1 and E1 is configured accordingly in the application, the window status is sent to the configured group address (object 14).
- Likewise, input E2 can be checked (object 16, condensate monitoring or window contact). 16, condensate monitoring and/or window contact).

Closing test mode:

- Test mode is closed with a Reset, i.e.
 - pressing the 2 keys simultaneously (>2 s)
 - by downloading the application
 - by interrupting and resetting the bus voltage

8.0 Technical data

Operating voltage:	230 V AC +10 % –14 %
Nominal frequency:	50 Hz
Power consumption:	max. 3 W
Power supply:	<12 mA
Maximum cable length (E1/E2):	5 m
Mode of operation:	Type 1

Outputs

Valves:	Triacs 0.5 A (24–230 V AC)
Additional relay:	16 A
Fan relay:	8 A

Permissible ambient temperature:	–5 °C to +45 °C
Protection class:	II subject to correct installation
Protection rating:	IP 20 in accordance with EN 60529
Equipment standard:	EN 60730-1

The device is suitable for use in conditions with a normal environment. Observe deviating technical data on the device rating plate! Technical changes reserved. The devices comply with European Directives 73/23/EEC (low-voltage directive) and 89/336/EEC (EMC Directive).

If the devices are combined with others for use within a system, ensure that the system as a whole does not cause radio interference.

The ETS database can be found under www.theben.de
Please refer to the Handbook for detailed functional descriptions.

Theben AG

Hohenbergstr. 32
72401 Haigerloch
GERMANY
Phone +49 (0) 74 74/6 92-0
Fax +49 (0) 74 74/6 92-150

Service

Phone +49 (0) 74 74/6 92-369
Fax +49 (0) 74 74/6 92-207
hotline@theben.de

Addresses, telephone numbers etc. at
www.theben.de